

# Catalogue 2013

**Scheibenbremsbeläge / Bremsscheiben / Radzylinder /  
Bremsschläuche / Trommelbremsbacken**  
*Disc Brake Pads / Brake Discs / Wheel Cylinder /  
Brake Hoses / Drum Brake Shoes*

**Baum** 

# Erläuterungen

Commentaires / Commento / Observações / Uwagi / Poznámky

## Produktgruppen

Groupes de produit / Gruppi prodotto / Grupos de Produto / Grupy produktów / Skupiny výrobků



### Scheibenbremsbeläge

Plaquette de frein / Pastiglie freno / Pastilhas de Travão de Disco / Klocki do hamulców tarczowych / Obložení kotoučové brzdy



### Bremsscheibe

Disque de frein / Disco freno / Disco de Travão / Tarcza hamulcowa / Brzdový kotouč



### Trommelbremsbacken

Mâchoires de frein à tambour / Ganascas freno / Maxilas / Szczęki hamulca bębnowego / Čelisti bubnové brzdy



### Radzylinder

Cylindre de roue / Cilindretto ruota / Cilindro de Roda / Cylinder hamulcowy koła / Kolový váleček



### Bremsschlauch

Flexible de frein / Flessibile freno / Tubo de Travão / Przewód hamulcowy giętki / Hadice brzdy

## Lenkungsart

Direction / Guida / Direcção / Rodzaj układu kierowniczego / Druh řízení

- ◀ Linkslenker / Conduite à gauche / Guida a sinistra / Vvolante à esquerda / z kierownicą z lewej strony / Volant vľavo
- ▶ Rechtslenker / Conduite à droite / Guida a destra / Volante à direita / z kierownicą z prawej strony / Volant vpravo

## Herstellerkennung

Fabricant / Fabricant / Fabricante / Producent / Označení výrobce

ATE	Continental Teves (ATE)	FI	Fiat
AKE	Akebono	FTE	FTE Automotive
AIS	Aisin	LUC	Lucas (TRW)
AP	AP Lockheed	MAN	Mando
BDX	Bendix	NIS	Nissin
BOS	Bosch	PER	Perrot
BRE	Brembo	SUM	Sumitomo
CIT	Citroën	TOK	Tokico
DEL	Delco	VW	Volkswagen

















## Abkürzungen

Abréviations / Abbreviazioni / Abreviaturas / Skróty / Zkratky

- Ohne/nicht / Sauf/sans / Senza/non / Salvo/sem / Bez/nie / Bez/na
- + Mit/nur/für / Avec/seulement/pour / Con/solo/per / Com/apenas/para / Z/tylko/do / S/jen/pro
- L Legiert/hochgekohlt / Allié/carbonise / In lega/lega di carbonio / Liga de Carbono / Stopowe/z dużą zawartością węgla / Legovaný/vysoce nauhličený
- L= Länge / Longueur / Lunghezza / Comprimento / Długość / Délka
- Rz Radzylinder / Cylindre de roue / Cilindretto ruota / Cilindro de roda / Cylinder hamulcowy koła / Kolový váleček
- RzR Radzylinder mit integriertem Regler / Cylindre de roue avec correcteur intégré / Cilindretto ruota con corretore / Cilindro de roda com regulador incorporado / Cylinder hamulcowy koła ze zintegrowanym regulatorem / Kolový váleček s integrovaným regulátorem
- S Fixierschraube/Sattelschraube / Vis d'étrier/vis de fixation / Viti fissaggio pinza/viti di fissaggio / Parafuso de fixaçao/parafuso da maxila / Śruba łącząca/śruba zacisku hamulca / Upevňovací šroub/šroubem třmenu
- V Belüftet / Ventilé / Ventilato / Větraný / Wentylowane / Větraný
- WE Warneinrichtung / Dispositif d'avertissement / Rilevatore usura incollato / Výstražné zařízení / Urządzenie ostrzegawcze / Výstražné zařízení
- WK Warnkontakt / Témoïn d'usure / Rilevatore usura a clip / Výstražným kontaktem / Stykiem ostrzegawczym / Výstražným kontaktem
- Zub Zuehör / Accessoires / Accessori / Příslušenstvím / Osprzętem / Příslušenstvím

## Einbauposition

### Positionnement / Posizione di montaggio / Posição de Montagem / Pozycja montażu / Montážní poloha

-  vorne / avant / davanti / à frente / z przodu / vpředu
-  hinten / arrière / dietro / atrás / z tylu / vzadu
-  links / gauche / a sinistra / esquerda / z lewej strony / vlevo
-  rechts / droite / a destra / direita / z prawej strony / vpravo
-  links vorne / avant gauche / davanti a sinistra / esquerda à frente / z lewej strony u góry / vlevo nahoře
-  links hinten / arrière gauche / dietro a sinistra / esquerda atrás / z lewej strony na dole / vlevo dole
-  rechts vorne / avant droite / davanti a destra / direita à frente / z prawej strony u góry / vpravo nahoře
-  rechts hinten / arrière droite / dietro a destra / direita atrás / z prawej strony na dole / vpravo dole
-  mitte / milieu / al centro / centro / po šrodku / uprostřed
-  oben / en haut / in alto / em cima / u góry / nahoře
-  unten / en bas / in basso / em baixo / na dole / dole
-  Vorderachse / essieu avant / asse anteriore / eixo dianteiro / Oś przednia / nahoře
-  Vorderachse links / essieu avant gauche / asse anteriore a sinistra / eixo dianteiro do lado esquerdo / z lewej strony z przodu / vlevo nahoře
-  Vorderachse rechts / essieu avant droite / asse anteriore a destra / eixo dianteiro do lado direito / z prawej strony z przodu / vpravo nahoře
-  Hinterachse / essieu arrière / asse posteriore / eixo traseiro / Oś tylna / dole
-  Hinterachse links / essieu arrière gauche / asse posteriore a sinistra / eixo traseiro esquerdo / z lewej strony z tylu / vlevo dole
-  Hinterachse rechts / essieu arrière droite / asse posteriore a destra / eixo traseiro direito / z prawej strony z tylu / vpravo dole

Sämtliche Positionsangaben beziehen sich immer auf die Fahrtrichtung.

Toutes positions vues en position de conduite.

Le indicazioni dei simboli si riferiscono alla direzione di marcia.

Todas as indicações de posição referem-se ao lado de condução.

Poszczególne pozycje zawsze w odniesieniu do kierunku jazdy.

Veškeré údaje o pozicích jsou vždy vztaženy na směr jízdy.

Nachdruck, auch auszugsweise, nur mit unserer Genehmigung gestattet. Ersatzansprüche auf Grund von Angaben in diesem Katalog können nicht anerkannt werden. Konstruktionsänderungen vorbehalten. Soweit wir in unseren Unterlagen Bezug nehmen auf die Ersatzteilnummer des Fahrzeugherstellers, dient dies nur zu Vergleichszwecken. Eine Verwendung derartiger Angaben in Rechnungen an den Fahrzeugbesitzer ist nicht statthaft. Die Modell- und Ersatzteilvielfalt einiger Fahrzeughersteller erlaubt nicht immer eine genaue Zuordnung. Bitte beachten Sie daher besonders die im Katalog aufgeführten Bemerkungen und Ersatzteilbeschreibungen.

## Inhaltsverzeichnis

### Table des matières / Sommario / Índice / Spis treści / Obsah

**Fahrzeugindex** ..... 1  
Index des véhicules / Indice del veicolo / Índice de vehículos /  
Rejestr pojazdów / Rejstřík vozidel

**Fahrzeugapplikationen** ..... 4  
Applications véhicule / Veicolo Applicazioni /  
Veículo Aplicações / Pojazd Aplikacje / Vozidlo Aplikace

**Abbildungen Scheibenbremsbeläge** ..... 426  
Illustrations plaquettes de frein à disque / Illustrazioni  
pastiglie freno / Figuras calços do travão de disco /  
Rysunki okładzin hamulców tarczowych / Zobrazení  
obložení kotoučových brzd

**Abbildungen Warnkontaktillustrations** ..... 495  
témoins d'usure / Illustrazioni rilevatori usura /  
Figuras avisador de desgaste / Rysunki styki ostrzegawcze /  
Zobrazení kontaktů indikátoru opotřebení

**Abbildungen Trommelbremsbacken** ..... 513  
Illustrations mâchoires de frein à tambour / Illustrazioni  
ganasse freno / Figuras Calços de travão de tambor /  
Rysunki szczepek hamulca bębnowego / Zobrazení čelistí  
bubnových brzd

**Abmessungen Bremsscheiben** ..... 517  
Dimensions disques de frein / Misure dischi freno /  
Dimensões dos discos dos travões / Wymiary tarcz  
hamulcowych / Rozměry brzdových kotoučů

**Abbildungen Bremsschläuche** ..... 525  
Illustrations flexibles de frein / Illustrazioni flessibili  
freno / Figuras tubos de travão / Rysunki przewód  
hamulcowy giętki / Hadice brzd

**Vergleichsliste WVA** ..... 528  
Liste des correspondances WVA / Tabella di conversione  
codici WVA / Lista de comparação WVA / Lista porównawcza  
numerów WVA / Porovnávací seznam čísel WVA

**Vergleichsliste** ..... 536  
Liste des correspondances / Tabella di conversione codici /  
Lista de comparação / Lista porównawcza numerów /  
Porovnávací seznam čísel

# Value for Money

D

## Bremsscheiben mit optimaler Preisleistung

Gut, dass BARUM-Bremsscheiben nicht nur im Preis, sondern auch in der Leistung überzeugen. Die wichtigsten Qualitätsmerkmale:

- Geringe Toleranzen
- Exakt auf das Fahrzeug abgestimmtes Material
- Ausgewuchtete Scheiben
- Stabile Verpackung mit allen wichtigen Informationen
- Hohe Zuverlässigkeit durch lückenlose Qualitätskontrolle



Gute Argumente für ein gutes Produkt!

## Bremsbeläge, die sich doppelt auszahlen

Was für die Bremsscheiben von BARUM gilt, das trifft auch auf die Beläge zu:

- Überzeugender Bremskomfort
- Erfüllt ECE-R90
- Optimales Verschleißverhalten
- Sehr gutes Fadingverhalten durch scorching
- Hohe Marktdeckung von ca. 90% in Europa

So rechnet sich die Bremse für Werkstatt und Kunde!

F

## Des disques de frein au rapport qualité / prix optimal

Soyez convaincus par les atouts des disques de frein BARUM : la qualité au meilleur prix. Les principaux atouts qualité :

- Faibles tolérances
- Matériau parfaitement adapté au véhicule
- Disques équilibrés
- emballage robuste avec toutes les informations importantes
- Fiabilité élevée grâce à des contrôles de qualité sans faille



De bons arguments pour un bon produit !

## Des plaquettes qui valent doublement le coup

La qualité des disques de frein BARUM est également exigée pour les plaquettes :

- Confort de freinage convaincant
- Conformés à la norme ECE-R90
- Comportement optimal à l'usure
- Très bon comportement au fading grâce à la combustion anticipée des gaz
- Une couverture de plus de 90% du marché européen

Avec de tels freins, tout le monde est gagnant : votre garage ainsi que votre client.

I

## Nessun fraintendimento: Dischi freno con ottimo rapporto qualità-prezzo

È importante che i dischi freno BARUM non siano convincenti solo nel prezzo, bensì anche nelle prestazioni. Le più importanti caratteristiche qualitative:

- Basse tolleranze
- Materiale specificatamente adattato al veicolo
- Dischi equilibrati
- Imballaggio robusto con tutte le informazioni importanti
- Elevata affidabilità grazie a un controllo di qualità ineccepibile



Buoni argomenti per un buon prodotto!

## Impossibile sbagliarsi: Pastiglie freno con doppio beneficio

Ciò che vale per i dischi freno BARUM, vale anche per le pastiglie:

- Comfort di frenata convincente
- Conforme all'ECE-R90
- Resistenza ottimale all'usura
- Ottimo comportamento fading grazie al processo di "scorching"
- Elevata copertura del mercato europeo pari a circa il 90%

Un freno che conviene all'officina e al cliente!

**Barum**

**P**

## Discos de travão com uma óptima relação preço-qualidade

Excelente! Os discos de travão BARUM não convencem apenas pelo preço, mas também pela boa performance. Principais características de qualidade:

- Tolerâncias reduzidas
- Material exactamente com as mesmas características de origem
- Discos calibrados
- Embalagem resistente com todas as informações importantes
- Alta fiabilidade devido a um completo controlo de qualidade

Bons argumentos para um bom produto!



## Pastilhas de travão com duplo retorno

As excelentes vantagens dos discos BARUM também se aplicam às pastilhas de travão:

- Conforto garantido em travagem
- Cumpre com a norma ECE-R90
- Óptimas características anti-desgaste
- Excelente comportamento de travagem mesmo sob altas temperaturas
- Alta fiabilidade devido a um completo controlo de qualidade
- Elevada cobertura do mercado com cerca de 90% na Europa

As vantagens que trazem valor acrescentado à oficina e cliente!

**PL**

## Tarcze hamulcowe w optymalnej cenie

Świetnie, że tarcze hamulcowe BARUM potrafią przekonać nie tylko ceną, ale również sprawnością. Najważniejsze cechy świadczące o jakości:

- Niskie tolerancje
- Materiał idealnie dostosowany do pojazdu
- Wyważone tarcze
- Stabilne opakowanie zawierające wszystkie najważniejsze informacje
- Niezawodne dzięki pełnej kontroli jakości

To są właśnie cechy dobrego produktu!



## Okładziny hamulcowe, które opłacają się podwójnie

To co odnosi się do tarcz hamulcowych BARUM, dotyczy również okładzin:

- Komfort hamowania, który przekonuje
- Spełniają normy ECE-R90
- Optymalnie się zużywają
- Bardzo dobry fading dzięki zastosowaniu technologii scorching
- Wysoki udział w rynku w Europie ok. 90%

Taki powinien być hamulec zakładany w warsztacie i oferowany klientowi!

**CZ**

## Brzdové kotouče s optimálním poměrem ceny a výkonu

Je dobré, že brzdové kotouče BARUM nepřesvědčují jen svou cenou, ale i výkonem. Nejdůležitějšími znaky kvality jsou:

- nepatrné tolerance
- materiál přesně sladěný s vozidlem
- vyvážené kotouče
- stabilní obal se všemi důležitými informacemi
- vysoká spolehlivost zásluhou soustavné kontroly jakosti

Dobré argumenty pro dobrý produkt!



## Brzdové obložení, které se vyplatí nadvakrát

To, co platí pro brzdové kotouče BARUM, platí i pro obložení:

- přesvědčující komfort brždění
- splňuje ECE-R90
- optimální chování při opotřebení
- velmi dobrý brzdňý účinek díky procesu zvanému scorching
- vysoké pokrytí trhu, které v Evropě dosahuje asi 90%

Tak se brzda vyplatí pro dílnu i pro zákazníka!

**Barum**

# Notizen

Notes / Note / Notas / Uwagi / Poznámky

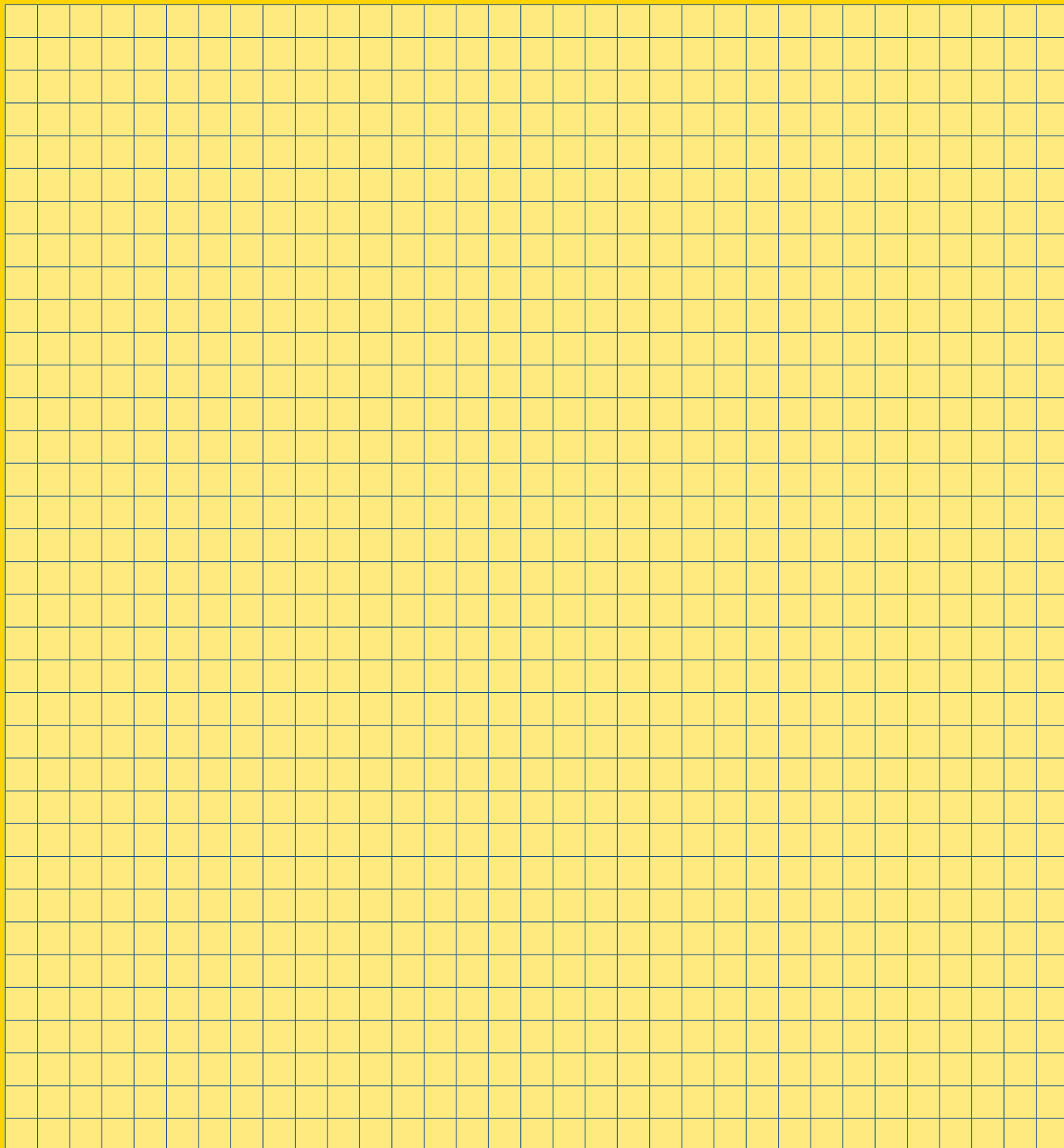

**ALFA ROMEO**

145 (94-01)	4
146 (94-01)	4
147 (01-10)	4
155 (92-97)	4
156 (97-05)	5
GT (04-10)	5
GTV (95-05)	5
MITO (08-)	5
SPIDER (95-05)	5

**AUDI**

80 (91-95)	6
80 Quattro (92-95)	6
100 (91-94)	7
100 Quattro (91-94)	8
A1 / A1 Sportback (10-)	8
A2 (00-05)	9
A3 (96-03)	9
A3 / A3 Sportback (03-)	10
A3 Cabrio (08-)	12
A4 (B5) (95-01)	13
A4 (B6/B7) (01-08)	15
A4 Cabrio (02-08)	20
A6 / A6 Avant (4A/C4) (94-97)	21
A6 / A6 Avant (4B/C5) (97-05)	22
A6 Allroad (00-05)	24
A6 (4F2/C6) Limousine (04-11)	25
A6 (4F5/C6) Avant (05-11)	26
A6 Allroad (06-11)	26
A8 (94-02)	27
A8 (03-09)	27
CABRIO (91-00)	27
COUPE (89-96)	28
COUPE Quattro (87-96)	28
Q3 (11-)	29
Q7 (06-)	29
TT Coupe (98-06)	29
TT Roadster (99-06)	30
TT Coupe (06-)	30
TT Roadster (07-)	31

**BMW**

1er Reihe/E81/E87 Limousine (04-11)	31
1er Reihe/E82 Coupe (07-)	31
1er Reihe/E88 Cabrio (08-)	32
3er Reihe/E36 (91-00)	32
3er Reihe/E46 (98-06)	34
3er Reihe/E90 Limousine (05-)	38
3er Reihe/E91 Touring (05-)	39
3er Reihe/E92 Coupe (06-)	40
3er Reihe/E93 Cabrio (07-)	40
5er Reihe/E34 (88-96)	40
5er Reihe/E39 (96-03)	41
5er Reihe/E60 Limousine (03-10)	43
5er Reihe/E61 Touring (04-10)	45
6er Reihe/E63 Coupe (04-11)	46
6er Reihe/E64 Cabrio (04-11)	46
7er Reihe/E32 (86-94)	47
7er Reihe/E38 (93-01)	47
7er Reihe/E65/E66 (02-08)	47
8er Reihe/E31 (90-99)	48
X1 (09-)	48
X3 (03-10)	48
X5 (00-07)	49
Z3 (95-02)	49
Z4 Roadster/E85 (03-08)	50
Z4 Coupe/E86 (06-08)	50
Z4 Roadster/E89 (09-)	50
Z8 (00-03)	50

**CHEVROLET**

AVEO (04-)	50
KALOS (05-08)	50
LANOS (05-)	50
MATIZ (05-)	51
SPARK (05-)	51

**CHRYSLER**

CROSSFIRE Coupe (03-08)	51
CROSSFIRE Cabrio (04-08)	51

**CITROEN**

AX (86-98)	51
BERLINGO (MF) Kombi (96-08)	52
BERLINGO (M_) Kasten (96-08)	53
BERLINGO (B9) (08-)	54
C1 (05-)	54
C2 (03-09)	54
C3 (02-09)	54
C3 Picasso (09-)	55
C3 Pluriel (03-10)	55

**CITROEN**

C3 II (09-)	55
C4 I Limousine (04-)	56
C4 I Coupe (04-10)	57
C4 I Grand Picasso (06-)	57
C4 I Picasso (07-)	57
C5 I Limousine (01-04)	57
C5 I Kombi (01-04)	57
C5 II Limousine (04-08)	57
C5 II Kombi (04-08)	58
C5 III Limousine (X7) (08-)	58
C5 III Kombi (X7) (08-)	58
C8 (02-)	58
C-CROSSER (07-)	58
DS3 (09-)	58
DS4 (11-)	59
EVASION (94-02)	59
JUMPER Bus (94-02)	59
JUMPER Kasten (94-02)	60
JUMPER Pritsche/Fahrgestell (94-02)	61
JUMPER (02-06)	62
JUMPER (06-)	63
JUMPY Kombi (95-06)	63
JUMPY Kasten (95-06)	64
JUMPY Pritsche/Fahrgestell (99-06)	65
JUMPY (07-)	65
NEMO (08-)	65
SAXO (96-04)	65
XANTIA (X1) Limousine (93-97)	66
XANTIA (X1) Kombi (95-97)	67
XANTIA (X2) Limousine (98-03)	67
XANTIA (X2) Kombi (98-03)	67
XM (Y3) Limousine (89-94)	67
XM (Y4) Limousine (94-00)	68
XSARA (N1) Limousine (97-05)	68
XSARA (N2) Kombi (97-05)	69
XSARA (N0) Coupe (97-05)	70
XSARA Picasso (N68) (00-10)	70
ZX (N2) Limousine (91-97)	71
ZX (N2) Kombi (93-98)	72

**Classic NFZ**

STEYR DAIMLER PUCH CITY-BUS (82-92)	73
-------------------------------------	----

**Classic PKW**

ALFA ROMEO ALFASUD (71-84)	73
ALFA ROMEO AR 6 (85-89)	73
ALFA ROMEO SPRINT (76-89)	73
AUDI 50 (74-78)	73
AUDI 80 (72-78)	73
AUDI 80 (79-81)	73
AUDI 80 (82-84)	74
AUDI 80 (84-87)	75
AUDI 80 (87-91)	75
AUDI 80 Quattro (78-86)	76
AUDI 80 Quattro (87-91)	76
AUDI 90 (85-87)	76
AUDI 90 (87-91)	76
AUDI 90 Quattro (84-87)	77
AUDI 90 Quattro (87-91)	77
AUDI 100 Quattro (85-90)	77
AUDI 100 (76-79)	78
AUDI 100 (80-81)	78
AUDI 100 (82)	78
AUDI 100 (83-90)	78
AUDI 200 Quattro (85-91)	79
AUDI 200 (80-83)	80
AUDI 200 (84-91)	80
AUDI COUPE (81-88)	80
AUDI COUPE Quattro (85-87)	80
AUDI QUATTRO (80-91)	80
AUDI V8 (88-94)	81
AUTOBIANCHI A 111 (69-72)	81
AUTOBIANCHI A 112 (69-86)	81
AUTOBIANCHI Y 10 (85-95)	81
BMW 3er Reihe/E21 (75-83)	81
BMW 3er Reihe/E30 (82-93)	81
BMW 5er Reihe/E12 (72-81)	82
BMW 5er Reihe/E28 (81-87)	82
BMW 6er Reihe/E24 (76-89)	82
BMW 7er Reihe/E23 (77-86)	83
BMW M1 (79-83)	83
BMW Z1 (88-91)	83
CITROEN BX (82-93)	83
CITROEN C15 (84-05)	84
CITROEN C25 (81-94)	84
CITROEN VISA (78-89)	84
FIAT 124 (66-74)	84
FIAT 125 (66-74)	84
FIAT 127 (71-86)	84
FIAT 128 (69-84)	84
FIAT 131 (74-84)	84
FIAT 132 (72-81)	84
FIAT DUCATO (81-93)	85
FIAT PANDA (80-85)	85
FIAT REGATA (83-89)	85
FIAT RITMO (78-88)	85
FIAT TEMPRA (90-93)	85

**Classic PKW**

FIAT TIPO (88-93)	86
FIAT UNO (83-89)	87
FIAT UNO (90-95)	87
FIAT X 1/9 (72-89)	87
FORD CONSUL / GRANADA (72-85)	87
FORD ESCORT / ORION (81-85)	88
FORD ESCORT / ORION (86-90)	88
FORD FIESTA (76-89)	88
FORD PROBE (91-92)	88
FORD SCORPIO / GRANADA (GB) (85-91)	88
FORD SCORPIO / GRANADA (GB) (92-94)	88
FORD SIERRA (82-86)	88
FORD SIERRA (87-93)	89
FORD TAUNUS / CORTINA (GB) (70-82)	90
HONDA ACCORD (81-85)	90
HONDA CIVIC (3-türig) (87-91)	90
HONDA CRX (87-91)	90
HYUNDAI STELLAR (84-90)	90
ISUZU TROOPER (86-91)	90
LADA NOVA (2104/2105) (75-96)	90
LADA 1200-1600 (2101/2102/2103/2106) (73-86)	90
LANCIA DEDRA (90-93)	90
LANCIA DELTA (79-86)	91
LANCIA DELTA (86-93)	91
LANCIA PRISMA (83-86)	91
LANCIA PRISMA (86-89)	91
LANCIA PRISMA (89-92)	91
LAND ROVER RANGE ROVER I (70-94)	91
MAZDA 626 Limousine/Coupe (87-91)	91
MERCEDES BENZ (R107) 280 SL-560 SL (71-89)	91
MERCEDES BENZ (R113) 230 SL-280 SL (63-71)	92
MERCEDES BENZ (R129) SL-Klasse (89-93)	92
MERCEDES BENZ (W108) 250 S-300 SEb (65-72)	92
MERCEDES BENZ (W109) 300 SEL (65-72)	92
MERCEDES BENZ (W111) 220-280 (59-71)	93
MERCEDES BENZ (W114) 230.6-280 CE (67-76)	93
MERCEDES BENZ (W115) 200-240 D 3.0 (67-76)	93
MERCEDES BENZ (W116) 280 S-450 SEL 6.9 (72-80)	93
MERCEDES BENZ (W123) 200-300 TD Turbo (76-85)	94
MERCEDES BENZ (W124) E-Klasse (85-93)	95
MERCEDES BENZ (W126) 260 SE-560 SEC (80-91)	97
MERCEDES BENZ (W201) 190-190 E 2.6 (82-93)	99
MERCEDES BENZ G-Klasse (W460) (79-93)	99
MERCEDES BENZ G-Klasse (W461) (90-)	99
MERCEDES BENZ Transporter (BM 601) 207 D-210 D	100
MERCEDES BENZ Transporter (BM 602) 307 D-310 D	100
MERCEDES BENZ Transporter (BM 611) 407 D-410 D	100
MERCEDES BENZ Transporter (BM 667) 507 D-510	100
MERCEDES BENZ Transporter (BM 668) 609 D	100
MERCEDES BENZ Transporter (BM 669) 709 D/711 D	100
MERCEDES BENZ Transporter (BM 670) 809 D-814 D	100
MINI COOPER (83-91)	100
MINI COOPER S (83-91)	101
NISSAN SUNNY (B12) Coupe (86-90)	101
NISSAN SUNNY (B12) Kombi (86-90)	101
NISSAN SUNNY (N13) (86-90)	101
OPEL ASCONA B / Vauxhall Cavalier (75-81)	101
OPEL ASCONA C / Vauxhall Cavalier (82-88)	101
OPEL CORSA A / Vauxhall Nova (83-92)	101
OPEL KADETT D / Vauxhall Astra D (79-84)	102
OPEL KADETT E / Vau. Astra E/Belmont (84-93)	102
OPEL MANTA B / Vauxhall Cavalier Coupe (76-88)	102
OPEL OMEGA A / Vauxhall Carlton (87-93)	103
OPEL REKORD E / Vauxhall Carlton (77-86)	103
OPEL SENATOR B / Vauxhall Royal (88-93)	103
PEUGEOT J5 (81-94)	103
PEUGEOT 205 (83-90)	104
PEUGEOT 305 (77-90)	104
PEUGEOT 405 (87-92)	104
RENAULT ALPINE A310 (77-84)	105
RENAULT ESPACE I (J/S 11_) (84-90)	105
RENAULT FUEGO (80-92)	105
RENAULT R5 SUPER (85-96)	105
RENAULT R9 (82-89)	106
RENAULT R11 (83-89)	106
RENAULT R17 (72-80)	107
RENAULT R18 Kasten (79-86)	107
RENAULT R18 Limousine (78-86)	107
RENAULT R18 Variable (79-86)	107
RENAULT R20 (76-84)	107
RENAULT R21 Limousine (B48/L48_) (86-93)	108
RENAULT R25 (84-92)	109
RENAULT R30 (75-84)	109
RENAULT TRAFIC I Bus (T5/T6/T7) (80-89)	109
RENAULT TRAFIC I Kasten (T1/T2/T3/T4) (80-89)	109
RENAULT TRAFIC I PROPULSION (PXX) (81-89)	110
SEAT FURA (82-86)	110
SEAT RONDA (83-86)	110
SKODA S 100 (70-77)	110
SKODA S 105 (77-90)	110
SKODA S 110 (70-82)	110
SKODA S 120 (77-90)	110
TALBOT MATRA BAGHEERA (74-80)	110
TALBOT MATRA MURENA (81-85)	110
TOYOTA CAMRY (82-86)	110
TOYOTA CAMRY (86-91)	110
TOYOTA CARINA II (83-87)	110
TOYOTA CELICA (85-89)	110
TOYOTA COROLLA (83-87)	111
TOYOTA CORONA (82-87)	111
TOYOTA MR2 (84-89)	111

**Classic PKW**

TOYOTA TERCEL (82-88)	111
VOLKSWAGEN CADDY I (83-92)	111
VOLKSWAGEN CORRADO (88-95)	111
VOLKSWAGEN DERBY/POLLO Stufenheck (77-88)	112
VOLKSWAGEN GOLF I Cabriolet (79-93)	112
VOLKSWAGEN GOLF I (74-83)	113
VOLKSWAGEN JETTA I (79-83)	113
VOLKSWAGEN JETTA II (84-92)	114
VOLKSWAGEN PASSAT Limousine (85-88)	115
VOLKSWAGEN PASSAT Variant (73-84)	116
VOLKSWAGEN PASSAT Variant (85-88)	117
VOLKSWAGEN PASSAT/SANTANA Limousine (73-84)	118
VOLKSWAGEN POLO I (75-81)	119
VOLKSWAGEN SCIROCCO I (74-83)	119
VOLKSWAGEN SCIROCCO II (84-92)	119
VOLKSWAGEN TRANSPORTER (Typ 2) (79-92)	120
VOLVO 240 Kombi (74-93)	120
VOLVO 240 Limousine (74-93)	120
VOLVO 260 Coupe (77-78)	121
VOLVO 260 Kombi (75-82)	121
VOLVO 260 Limousine (74-82)	121
VOLVO 740 Kombi (85-92)	121
VOLVO 740 Limousine (83-92)	121
VOLVO 760 Kombi (82-92)	122
VOLVO 760 Limousine (82-92)	122

**DACIA**

DUSTER (HS_) (10-)	122
LOGAN Express (FS_) (09-)	122
LOGAN Limousine (LS_) (04-)	122
LOGAN MCV Kombi (KS_) (07-)	123
LOGAN Pick-up (US_) (08-)	124
SANDERO (08-)	124

**DAEWOO**

ARANOS (95-97)	124
CIELO (94-98)	124
ESPERO (95-99)	124
KALOS (02-05)	125
LANOS (97-02)	125
MATIZ (98-05)	125
NEXIA (95-97)	125
NUBIRA (97-99)	125
NUBIRA (99-05)	125

**FIAT**

500 (07-)	125
500C Cabrio (09-)	126
BARCETTA (95-04)	126
BRAVA (95-01)	126
BRAVO (95-01)	126
BRAVO (07-)	127
CINQUECENTO (92-98)	127
COUPE (94-00)	127
CROMA (91-96)	127
CROMA (05-10)	128
DOBLO (01-10)	128
DUCATO (94-02)	128
DUCATO (02-06)	130
DUCATO (06-)	130
FIORINO / FIORINO QUBO (08-)	131
GRANDE PUNTO (06-11)	131
IDEA (04-)	131
LINEA (07-11)	132
MAREA (96-02)	132
MULTIPLA (98-08)	132
PALIO / PALIO WEEKEND EUROPA (97-06)	133
PANDA (86-02)	133
PANDA (03-)	133
PANDA SUV (06-)	133
PANDA (12-)	133
PUNTO (93-00)	133
PUNTO (00-03)	134
PUNTO (03-06)	134
SCUDO (95-06)	135
SCUDO (07-)	135
SEICENTO (98-08)	135
STILO / STILO Multi Wagon (01-08)	135
STRADA / PICK-UP (99-)	136
STRADA II (11-)	136
TALENTO (88-94)	136
TEMPRA (93-96)	136
TIPO (93-95)	136
ULYSSE (94-02)	137
ULYSSE (02-11)	137

**FORD**

C-MAX (07-10)	137
C-MAX / GRAND C-MAX (10-)	138
COUGAR (98-00)	138
ESCORT / ORION (91-94)	138
ESCORT VII (95-00)	139
FIESTA III (89-96)	139

**FORD**

FIESTA IV (96-02)	140
FIESTA V (02-08)	141
FOCUS I (98-04)	141
FOCUS II (05-11)	142
FOCUS III (11-)	142
FOCUS C-MAX (03-07)	143
FUSION (02-)	143
GALAXY I (95-06)	143
GALAXY II (06-)	144
KA I (96-08)	144
KA II (09-)	144
KUGA (08-)	145
MAVERICK (93-96)	145
MAVERICK (97-98)	145
MONDEO I (93-96)	145
MONDEO II (96-00)	145
MONDEO III (00-06)	146
MONDEO IV (07-)	146
PROBE (93-97)	147
PUMA (97-01)	147
SCORPIO / GRANADA (GB) (95-98)	147
S-MAX (06-)	147
STREET KA (03-06)	148
TOURNEO (94-00)	148
TOURNEO CONNECT (03-)	148
TRANSIT (92-94)	148
TRANSIT (95-00)	150
TRANSIT (00-06)	151
TRANSIT (06-)	152
TRANSIT CONNECT (03-)	152

**HONDA**

ACCORD (90-93)	152
ACCORD (93-98)	152
ACCORD (98-02)	152
ACCORD Coupe (98-03)	152
CITY (08-)	153
CIVIC (3-türig) (91-95)	153
CIVIC (4-türig) (91-95)	153
CIVIC (3/4-türig) (95-01)	153
CIVIC (3-türig) (01-05)	153
CIVIC (4-türig) (01-05)	153
CIVIC (5-türig) (94-96)	153
CIVIC (5-türig) (97-01)	153
CIVIC (5-türig) (01-05)	153
CIVIC Hatchback (FK/FN) (05-)	154
CIVIC Stufenheck (FD) (05-)	154
CIVIC AERODECK (98-01)	154
CIVIC COUPE (94-95)	154
CIVIC COUPE (96-01)	154
CIVIC COUPE (01-04)	154
CONCERTO (90-95)	154
CRX (92-98)	154
INSIGHT (09-)	154
INTEGRA R (97-01)	154
JAZZ (02-08)	155
JAZZ (08-)	155
LOGO (99-02)	155
PRELUDE (92-96)	155
PRELUDE (96-00)	155
S2000 (99-04)	155

**HYUNDAI**

ACCENT I (94-99)	155
ACCENT II (00-05)	155
ELANTRA (00-06)	155
ELANTRA (06-)	155
GETZ (02-09)	155
GRANDEUR (99-05)	156
GRANDEUR (05-)	156
HIGHWAY VAN (00-04)	156
LANTRA/ELANTRA (90-95)	156
LANTRA/ELANTRA (95-00)	156
LANTRA (00-03)	156
MATRIX (01-08)	156
PONY/EXCEL (89-94)	156
PONY/EXCEL (94-95)	156
S-COUPE (90-96)	156
SANTA FE (SM) (01-06)	157
SANTAMO (98-02)	157
SONATA (98-04)	157
SONATA (05-)	157
TRAJET (00-08)	157
TUCSON (04-)	157
XG (98-05)	157
XG (05-)	157

**IVECO**

DAILY I / GRINTA (78-99)	157
DAILY II (99-06)	158

**JAGUAR**

S-Type (CCX) (99-08)	158
----------------------	-----

**JAGUAR**

X-Type (CF1) Limousine (01-)	158
X-Type (CF1) Kombi (04-)	158
XF (CC9) (08-)	159
XJ (X350,X358) (03-)	159
XK Coupe (06-)	159
XK Convertible (06-)	159

**KIA**

JOICE (00-03)	159
MAGENTIS (01-05)	159
MAGENTIS (05-)	159
RIO I (DC) (00-05)	159
SPORTAGE (04-10)	159
VENGA (10-)	159

**LADA**

110 Stufenheck (2110) (95-07)	159
111 Kombi (2111) (95-08)	160
112 Fließheck (2112) (95-08)	160
FORMA (2108) (89-95)	160
KALINA (1117/1118/1119) (04-)	160
PRIORA (2170/2172) (08-)	160
SAMARA (2108/2109) (86-99)	160
TOSCANA (2107) (83-96)	160

**LANCIA**

DEDRA (94-99)	160
DELTA (94-99)	161
DELTA (08-)	161
LYBRA (99-05)	161
MUSA (04-)	161
PHEDRA (02-10)	162
THEMA (92-94)	162
Y 10 (85-95)	162
Y (96-03)	162
YPSILON (03-11)	162
YPSILON (11-)	162
ZETA (94-02)	162

**LAND ROVER**

DISCOVERY I (89-98)	163
DISCOVERY II (94-04)	163
DISCOVERY III (04-09)	163
FREELANDER (LN) (98-06)	163
FREELANDER 2 (FA) (07-)	163
RANGE ROVER III (LM) (02-)	163
RANGE ROVER SPORT (LS) (05-)	163

**MAZDA**

121 (91-96)	163
121 (96-03)	163
2 (03-07)	164
3 (03-09)	164
3 (09-)	164
323 Limousine/323 F (89-94)	164
323 Limousine/323 C/323 F/323 S (94-98)	165
323 Limousine/323 F/323 P/323 S (98-03)	165
5 (05-)	165
6 Limousine (GG) (02-07)	165
6 Kombi (GY) (02-07)	165
6 (07-)	166
626 (91-97)	166
626 (97-02)	166
626 Kombi (88-92)	166
626 Kombi (92-98)	166
626 Kombi (98-02)	166
DEMIO (98-02)	166
DEMIO (03-)	166
MX-3 (91-98)	167
MX-5 (89-98)	167
MX-6 (91-97)	167
PREMACY (99-05)	167
PREMACY (05-)	167
XEDOS 6 (92-00)	167

**MERCEDES BENZ**

A-Klasse (W168) (97-04)	167
A-Klasse (W169) (04-11)	168
B-Klasse (W245) (05-11)	168
C-Klasse (W202) Limousine (93-00)	168
C-Klasse (S202) Kombi (96-01)	170
C-Klasse (W203) Limousine (00-07)	171
C-Klasse (S203) Kombi (01-07)	175
C-Klasse (CL203) Sportcoupe (01-08)	178
C-Klasse (CLC203) Coupe (08-10)	179
C-Klasse (W204) Limousine (07-)	179
C-Klasse (S204) Kombi (07-)	180
C-Klasse (C204) Coupe (11-)	181
CL-Klasse (C140) Coupe (96-99)	181



**MERCEDES BENZ**

CL-Klasse (C215) Coupe (99-06)	181
CL-Klasse (C216) Coupe (06-)	181
CLK-Klasse (C208) Coupe (97-02)	181
CLK-Klasse (A208) Cabrio (98-03)	182
CLK-Klasse (C209) Coupe (02-09)	182
CLK-Klasse (A209) Cabrio (03-09)	183
CLS-Klasse (C219) Coupe (04-10)	184
CLS-Klasse (C218) Coupe (10-)	184
CLS-Klasse (X218) Shooting Brake (12-)	184
E-Klasse (W124) (93-97)	184
E-Klasse (W210) Limousine (95-02)	186
E-Klasse (S210) Kombi (96-03)	188
E-Klasse (W211) Limousine (02-09)	189
E-Klasse (S211) Kombi (03-09)	191
E-Klasse (W212) Limousine (09-)	191
E-Klasse (S212) Kombi (09-)	192
E-Klasse (C207) Coupe (09-)	193
E-Klasse (A207) Cabrio (10-)	193
G-Klasse (W463) (90-)	193
G-Klasse (W463) Cabrio (90-)	194
GLK-Klasse (X204) (08-)	194
M-Klasse (W163) (98-05)	194
M-Klasse (W166) (11-)	195
S-Klasse (W140) (91-93)	195
S-Klasse (W140) (93-98)	195
S-Klasse (W220) (98-06)	196
S-Klasse (W221) (06-)	196
SL-Klasse (R129) (93-01)	197
SL-Klasse (R230) (01-11)	197
SL-Klasse (R231) (12-)	197
SLK-Klasse (R170) (96-04)	197
SLK-Klasse (R171) (04-11)	198
SLK-Klasse (R172) (11-)	198
SLR-Klasse (C199) Coupe (04-09)	198
VANEO (BM414) (02-05)	198
V-Klasse (BM638) (96-03)	199
VIANO (BM639) (03-)	200
VITO (BM638) (96-03)	200
VITO (BM639) (03-)	200
Transporter (BM 631) MB 100 D (87-96)	201
Transporter (BM 901/902) SPRINTER (95-06)	201
Transporter (BM 903/904) SPRINTER (95-06)	202
Transporter (BM 905) SPRINTER (01-06)	204
Transporter (BM 906) SPRINTER (06-)	204
Transporter VARIO (96-)	204

**MG**

ZR (01-05)	204
ZS (01-05)	205
ZT Limousine (01-05)	205
ZT-T Kombi (01-05)	205
MGF (RD) (95-02)	205
MG TF (02-05)	205

**MINI**

R50/R53 (00-06)	205
R52 Cabrio (04-08)	205
R55 Clubman (07-)	205
R56 (06-)	206
R57 Cabrio (09-)	206
R58 Coupé (11-)	206
R59 Roadster (12-)	206
R60 Countryman (10-)	206

**MINI**

CARISMA (95-06)	207
COLT/LANCER Limousine (88-92)	207
COLT/LANCER Limousine (92-96)	207
COLT (04-)	207
COLT CZC Cabriolet (06-08)	208
ECLIPSE I (91-95)	208
ECLIPSE II (95-99)	208
GALANT (4-türig) (87-92)	208
GALANT (5-türig) (88-92)	208
GALANT (92-96)	208
GALANT (96-03)	208
L 200 (86-96)	209
L 200 (96-06)	209
L 300 (86-94)	209
L 400 (96-02)	209
LANCER Evolution (04-07)	209
LANCER Kombi (92-96)	209
OUTLANDER I (03-)	209
OUTLANDER II (06-)	209
PAJERO (90-00)	209
PAJERO (00-06)	209
PAJERO SPORT / MONTERO (USA) (98-)	210
SANTAMO (99-03)	210
SPACE GEAR (95-00)	210
SPACE RUNNER (91-99)	210
SPACE RUNNER (99-03)	210
SPACE STAR (98-06)	210
SPACE WAGON (91-98)	210
SPACE WAGON (98-05)	211

**NISSAN**

100 NX (B13) (90-94)	211
ALMERA (N16) (00-06)	211
ALMERA TINO (V10M) (00-05)	211
INTERSTAR (X70) (02-)	212
KUBISTAR (X76) Kombi (03-)	212
MAXIMA (CA33) (00-06)	212
MICRA (K11E) (92-02)	213
MICRA (K12E) (03-)	213
MICRA C+C (CK12E) (05-)	213
NOTE (E11E) (06-)	213
PICK-UP (D22) (98-07)	213
PRIMASTAR (X83) Bus (01-)	213
PRIMASTAR (X83) Van (02-)	213
PRIMERA (P10E) Limousine (90-96)	214
PRIMERA (P11E) Limousine (96-02)	214
PRIMERA (P12E) Limousine (02-08)	214
PRIMERA (W11) Kombi (98-02)	214
PRIMERA (W12) Kombi (02-08)	215
SERENA/VANETTE CARGO (C23M/963) (92-01)	215
SUNNY (N14) Limousine (90-95)	215
SUNNY (Y10) Kombi (90-00)	215
TERRANO I (WD21) (87-97)	215
TERRANO II (R20) (93-06)	215
X-TRAIL (T30) (01-07)	216

**OPEL**

AGILA (00-07)	216
AGILA (08-)	216
ARENA (97-01)	216
ASTRA F / Vauxhall Astra MKIII (91-01)	216
ASTRA G / Vauxhall Astra MKIV (98-04)	217
ASTRA H / GTC / Vauxhall Astra MKV (04-10)	219
ASTRA H Caravan/Vau. Astra MKV Estate (04-10)	221
ASTRA H TwinTop (06-)	221
CALIBRA / Vauxhall Calibra (89-97)	221
CAMPO (91-96)	221
CAMPO (97-01)	221
COMBO / Vauxhall Combo (01-)	221
CORSA B / Vauxhall Corsa (93-00)	222
CORSA C / Vauxhall Corsa MK II (00-06)	223
CORSA D / Vauxhall Corsa MK III (06-)	223
FRONTERA A (92-98)	223
GT (07-09)	223
MERIVA A / Vauxhall Meriva A (02-10)	223
MERIVA B (10-)	224
MOVANO A (98-10)	224
OMEGA B / Vauxhall Omega (94-03)	225
SIGNUM / Vauxhall Signum (03-08)	225
SPEEDSTER / Vauxhall VX220 (00-05)	226
TIGRA / Vauxhall Tigra (94-00)	226
TIGRA TWIN TOP / Vau. Tigra Twin Top (04-09)	226
VECTRA A / Vauxhall Cavalier (89-95)	226
VECTRA B / Vauxhall Vectra (96-02)	227
VECTRA C (F68,F69)/Vau. Vectra MK II (02-08)	228
VECTRA C Caravan (F35) / Vau. MK II (03-08)	229
VIVARO (01-)	230
ZAFIRA I / Vauxhall Zafira I (99-05)	230
ZAFIRA II / Vauxhall Zafira II (05-11)	231

**PEUGEOT**

106 (91-96)	231
106 (96-04)	232
107 (05-)	233
205 (91-98)	233
206 Limousine (98-09)	233
206 CC (00-07)	234
206 SW (02-07)	234
206 PLUS (09-)	235
207 Limousine (06-)	235
207 CC (07-)	235
207 SW (07-)	236
208 (12-)	236
306 Limousine (3/5-türig) (93-01)	236
306 Limousine (4-türig) (94-01)	237
306 Cabriolet (94-03)	238
306 Kombi (97-02)	238
307 Limousine (00-07)	239
307 Break (02-08)	240
307 CC (03-09)	241
307 SW (02-08)	241
308 Limousine (07-)	242
308 SW (08-)	242
308 CC (09-)	242
3008 (09-)	242
309 (85-93)	242
405 (93-95)	243
406 Limousine (95-04)	243
406 Kombi (96-04)	244
406 Coupe (97-05)	244
806 (94-02)	245
807 (02-)	245
1007 (05-)	245
4007 (07-)	246
5008 (09-)	246
BIPPER (08-)	246
BOXER Bus (94-02)	246
BOXER Kasten (94-02)	247

**PEUGEOT**

BOXER Pritsche/Fahrgestell (94-02)	248
BOXER (02-06)	249
BOXER (06-)	250
EXPERT Kombi (95-06)	250
EXPERT Kasten (95-06)	251
EXPERT Pritsche/Fahrgestell (95-06)	252
EXPERT Tepee (07-)	252
PARTNER Kombi (96-08)	252
PARTNER Kasten (96-08)	253
PARTNER Tepee/Kasten (B9) (08-)	254

**PORSCHE**

911 (996) (97-05)	254
911 TARGA (996) (01-05)	254
911 CABRIO (996) (98-05)	254
911 COUPE (997) (04-)	255
911 CABRIO (997) (05-)	255
BOXSTER (986) (96-04)	255
BOXSTER (987) (05-11)	255
CAYENNE I (03-10)	255
CAYMAN (987C) (05-)	256

**PROTON**

PERSONA 400 (94-00)	256
SATRIA (00-)	256

**RENAULT**

AVANTIME (01-03)	256
CLIO I Limousine (B/C 57_) (90-98)	256
CLIO I Kasten (S 57_) (91-98)	258
CLIO II Limousine (BB_/CB_) (98-)	258
CLIO II Kasten (SB_) (99-)	259
CLIO III (BR_/CR_) (05-)	260
CLIO III Grandtour (KR_) (08-)	260
ESPACE II (J/S 63_) (91-96)	261
ESPACE III (JE_) (96-02)	261
ESPACE IV (JK_) (02-)	261
EXPRESS/RAPID (F40_) (85-98)	261
KANGOO I (KC_) (98-07)	262
KANGOO Express/Rapid (FC_) (98-07)	263
LAGUNA I Limousine (B56/556_) (93-00)	264
LAGUNA I Grandtour (K56_) (95-00)	265
LAGUNA II Limousine (BG_) (01-07)	266
LAGUNA II Grandtour (KG_) (01-07)	267
LAGUNA III Limousine (BT0/1) (07-)	267
LAGUNA III Coupe (DT0/1) (07-)	267
LAGUNA III Grandtour (KT0/1) (07-)	267
LOGAN (LS_) (04-)	268
LOGAN Kombi (KS_) (04-)	268
MASTER I Bus (80-98)	268
MASTER I Kasten (80-98)	268
MASTER I Pritsche/Fahrgestell (80-98)	269
MASTER II Bus (JD/ND_) (98-06)	269
MASTER II Kasten (FD_) (98-06)	269
MASTER II Pritsche/Fahrgestell (ED/HD/UD_) (98-06)	269
MASTER III Bus (JD_) (06-)	270
MASTER III Kasten (FD_) (06-)	270
MASTER III Pritsche/Fahrgestell (ED/HD/UD_) (06-)	270
MEGANE I Limousine 3/5-türig (BA/SA_) (96-02)	270
MEGANE I Classic (LA_) (96-02)	271
MEGANE I Coach (DA_) (95-03)	273
MEGANE I Cabrio (EA_) (96-03)	273
MEGANE I Grandtour (KA_) (98-03)	274
MEGANE II Limousine 3/5-türig (BM/CM_) (02-)	274
MEGANE II Limousine 4-türig (LM_) (03-)	275
MEGANE II Coupe/Cabrio (EM_) (03-)	276
MEGANE II Grandtour (KM_) (03-)	276
MEGANE SCENIC (JA_) (96-99)	277
MODUS/GRAND MODUS (JP0_) (04-)	278
R19 (3/5-türig) (B53/C53/S53_) (88-95)	278
R19 CHAMADE (L53_) (89-95)	279
R19 Cabriolet (D53_) (91-96)	280
R21 NEVADA (K48_) (86-95)	280
SAFRANO (B54_) (92-00)	281
SANDERO (B50_) (09-)	282
SCENIC I (JA_) (99-03)	282
SCENIC II (JM_) (03-09)	282
GRAND SCENIC (JM_) (04-09)	283
THALIA (LB_) (98-)	283
TRAFIC I Propulsion (PXX) (89-97)	284
TRAFIC I Kasten (TXX) (89-01)	284
TRAFIC I Bus (TXW) (89-01)	284
TRAFIC II (JL/FL/EL) (01-)	285
TWINGO I Limousine (C06_) (93-07)	285
TWINGO I Kasten (S06_) (93-07)	286
TWINGO II (CN0_) (07-)	286
VEL SATIS (BJ0_) (02-)	286
WIND (E4M_) (10-)	286

**ROVER**

25-Serie (RF) (99-)	286
45-Serie (RT) (00-)	287
75-Serie (RJ) (99-04)	287

**ROVER**

75 Serie (RX) (04-)	287
100-Serie (XP) (90-98)	287
200-Serie (XW) (90-95)	287
200 II-Serie (RF) (96-00)	287
400-Serie (XW) (90-95)	288
400-Serie (RT) (95-00)	288
600-Serie (RH) (93-99)	288

**SAAB**

9-3 Limousine (YS3D) (98-02)	288
9-3 Limousine (YS3F) (03-)	288
9-3 SportCombi (05-)	290
9-3 Coupe (YS3D) (98-02)	291
9-3 Cabriolet (YS3D) (98-03)	291
9-3 Cabriolet (YS3F) (03-)	292
9-3 X (09-)	293
9-5 Limousine (YS3E) (97-10)	293
9-5 Kombi (YS3E) (98-10)	294
900 (94-98)	295

**SEAT**

ALHAMBRA I (7V) (96-10)	295
ALHAMBRA II (10-)	296
ALTEA (5P1) (04-)	296
ALTEA XL (5P5) (06-)	298
AROSA (6H) (97-05)	299
CORDOBA I (93-99)	300
CORDOBA II (6K2) (99-02)	301
CORDOBA III (6L2) (02-09)	301
EXEO / ST (09-)	302
IBIZA I (85-92)	303
IBIZA II (93-99)	303
IBIZA III (6K1) (99-02)	306
IBIZA IV (6L1) (02-10)	308
IBIZA V / ST / SPORTCOUPE (08-)	310
INCA (6K9) (96-03)	311
LEON I (1M1) (99-05)	312
LEON II (1P1) (05-)	314
MALAGA (85-92)	316
MARBELLA (87-98)	316
Mii (12-)	316
TERRA (87-96)	316
TOLEDO I (1L) (91-98)	317
TOLEDO II (1M2) (98-04)	317
TOLEDO III (5P2) (05-09)	320

**SKODA**

CITIGO (12-)	320
FABIA I (6Y) (99-07)	321
FABIA II (5J) (07-)	322
FAVORIT (781) (87-95)	323
FELICIA I (791/795) (95-97)	323
FELICIA II (6U) (98-01)	324
FELICIA PICK-UP (797) (97-00)	324
FORMAN (785) (91-95)	324
OCTAVIA I (1U) (97-10)	324
OCTAVIA II (1Z) (04-)	326
PICK-UP (93-95)	327
ROOMSTER (5J) (06-)	328
SUPERB I (3U4) (02-08)	329
SUPERB II (08-)	330
SUPERB Kombi (09-)	331
YETI (09-)	331

**SMART**

CABRIO (BM450) (00-03)	332
CITY COUPE (BM450) (98-04)	332
CROSSBLADE (BM450) (02-04)	333
FORFOUR (BM454) (04-06)	333
FORTWO CABRIO (BM450) (04-07)	333
FORTWO COUPE (BM450) (04-07)	333
FORTWO CABRIO (BM451) (07-)	334
FORTWO COUPE (BM451) (07-)	334
ROADSTER (BM452) (03-05)	334
ROADSTER COUPE (BM452) (03-05)	334

**SUBARU**

JUSTY (G3X) (03-07)	334
---------------------	-----

**SUZUKI**

IGNIS II (03-)	334
SPLASH (08-)	334
SWIFT III (05-)	334
SX4 (06-)	335
WAGON R+ (00-)	335

**TOYOTA**

AVENSIS (03-09)	335
-----------------	-----

**TOYOTA**

AYGO (05-)	335
CARINA II (87-92)	335
CARINA E (92-97)	335
CELICA (89-93)	335
CELICA (93-99)	336
CELICA (99-05)	336
COROLLA (87-92)	336
COROLLA (92-97)	336
COROLLA (97-02)	336
COROLLA (02-04)	337
COROLLA (04-06)	337
COROLLA VERSO (02-04)	337
COROLLA VERSO (04-)	337
IQ (09-)	337
MR2 (00-05)	337
PASEO (91-95)	338
PASEO (95-99)	338
PICNIC (96-01)	338
PREVIA (05-)	338
PRIUS (00-03)	338
PRIUS (03-)	338
RAV4 I (94-00)	338
STARLET (89-96)	338
STARLET (96-99)	338
YARIS (99-05)	338
YARIS VERSO (99-05)	339

**VOLKSWAGEN**

BORA (98-04)	339
CADDY II (96-03)	343
CADDY III (04-)	343
CADDY Pickup (97-02)	345
CC COUPE (11-)	345
CRAFTER (06-)	345
EOS (06-)	345
FOX (05-)	346
GOLF II (84-93)	346
GOLF III (92-97)	348
GOLF III Variant (93-99)	350
GOLF III Cabriolet (94-02)	352
GOLF IV (98-03)	352
GOLF IV Variant (99-06)	355
GOLF V (03-08)	357
GOLF V Variant (07-09)	359
GOLF VI (08-)	360
GOLF VI Variant (09-)	362
GOLF VI Cabriolet (11-)	363
GOLF Plus (05-)	363
JETTA V (05-10)	365
JETTA VI (11-)	366
LT/- 4x4 (75-96)	367
LT/- 4x4 (96-06)	367
LUPU (98-05)	367
NEW BEETLE (98-10)	368
NEW BEETLE Cabriolet (03-10)	369
BEETLE (11-)	370
PASSAT (88-93)	370
PASSAT (94-96)	371
PASSAT (97-05)	372
PASSAT Limousine (05-10)	374
PASSAT Variant (05-10)	375
PASSAT CC (08-11)	377
PASSAT / PASSAT VARIANT (10-)	377
PASSAT ALLTRACK (12-)	378
POLO II (81-94)	378
POLO III (95-01)	379
POLO IV (02-09)	380
POLO V (09-)	382
POLO Classic (96-01)	383
POLO Variant (97-01)	384
SCIROCCO (08-)	385
SHARAN I (95-10)	386
SHARAN II (10-)	387
TIGUAN (07-)	387
TOUAREG I (03-10)	387
TOURAN (03-)	388
TRANSPORTER (T4) (90-03)	389
TRANSPORTER (T5) (03-)	391
VENTO (92-98)	395
up (11-)	396

**VOLVO**

440 (88-96)	396
460 (88-96)	397
480 (86-96)	397
850 Limousine (91-96)	397
850 Kombi (92-96)	397
940 I Limousine (90-95)	397
940 I Kombi (90-95)	398
940 II Limousine (95-98)	398
940 II Kombi (95-98)	399
960 I Limousine (90-94)	399
960 I Kombi (90-94)	399
960 II Limousine (94-96)	399
960 II Kombi (94-96)	399
C30 Coupe (06-)	399
C70 Coupe (97-02)	400









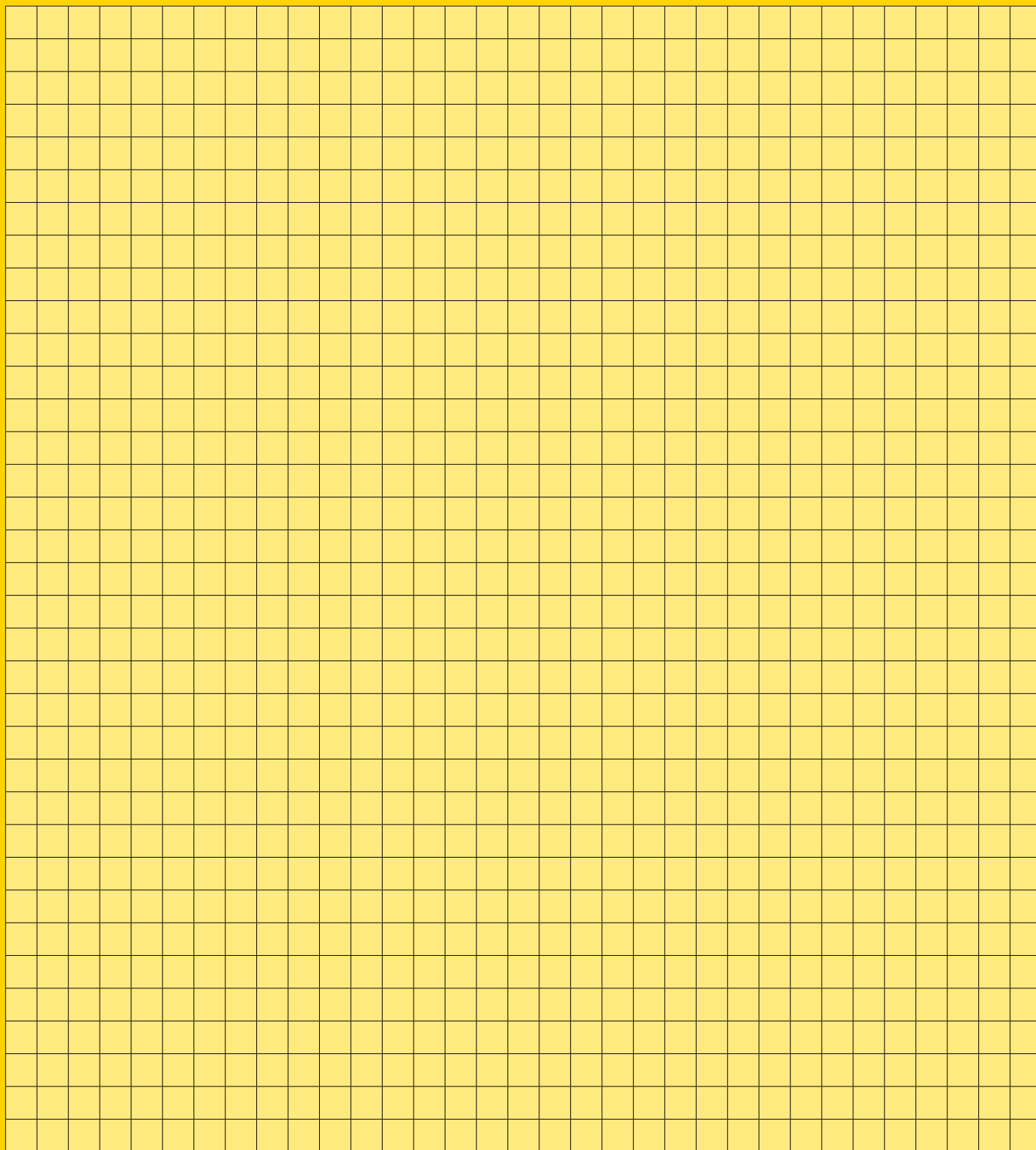

















**VOLVO**

C70 I Cabrio (98-06)	400
C70 II Cabrio (06-)	401
S40 I (95-03)	401
S40 II (04-)	402
S60 I (00-09)	403
S60 II (10-)	403
S70 (97-00)	403
S80 I (98-06)	404
S80 II (06-)	405
S90 (97-98)	405
V40 (95-04)	405
V50 (04-)	406
V60 (10-)	407
V70 I (97-00)	407
V70 II (00-07)	408
V70 III (07-)	409
V90 (97-98)	409
XC70 I CROSS COUNTRY (00-07)	409
XC70 II CROSS COUNTRY (07-)	409





















# Notizen

Notes / Note / Notas / Uwagi / Poznámky



								
<b>ALFA ROMEO 145 (94-01)</b>								
	1.4 i.e. 1.6 i.e. 1.7 i.e. 16V 2.0 TD	66 76 66	07.94 07.94 07.94 07.94	12.96 12.96 12.96 12.96	BA2034			20833 17,1 +/WK/S LUC
	1.4 i.e. 1.6 i.e. 2.0 TD	66 76 66	07.94 07.94 07.94	12.96 12.96 12.96	BAR12127			257 12,0 10,2
	1.4 i.e. T.Spark 1.6 i.e. T.Spark 1.7 i.e. 16V 1.9 JTD 2.0 TD	76 88 77 66	01.97 01.97 07.94 02.99 01.97	02.01 02.01 12.96 02.01 02.99	BAR20142			258 20,0 18,2 V L
	1.4 i.e. 1.4 i.e. T.Spark 1.6 i.e. 1.6 i.e. T.Spark 1.7 i.e. 16V 1.8 i.e. T.Spark 1.9 JTD 2.0 i.e. 16V 2.0 TD	66 76 76 88 77 66	07.94 01.97 07.94 01.97 07.94 01.97 02.99 10.95 07.94	12.96 + ABS 02.01 + ABS 12.96 + ABS 02.01 + ABS 12.96 02.01 02.01 + ABS 02.01 02.99 + ABS	BA2035		+ GG-Sättel <sup>1)</sup>	21103 14,4 /S LUC
	2.0 i.e. 16V		10.95	02.01 + 	BAR11119			240 11,0 9,2
	1.4 i.e. 1.6 i.e. 2.0 TD	66 76 66	07.94 07.94 07.94	12.96 - ABS 12.96 - ABS 12.96 - ABS	BAW2008			Rz 20,64
<b>ALFA ROMEO 146 (94-01)</b>								
	1.4 i.e. 1.6 i.e. 1.7 i.e. 16V 2.0 TD	66 76 66	12.94 12.94 12.94 12.94	12.96 12.96 12.96 12.96	BA2034			20833 17,1 +/WK/S LUC
	1.4 i.e. 1.6 i.e. 2.0 TD	66 76 66	12.94 12.94 12.94	12.96 12.96 12.96	BAR12127			257 12,0 10,2
	1.4 i.e. T.Spark 1.6 i.e. T.Spark 1.7 i.e. 16V 1.9 JTD 2.0 TD	76 88 77 66	01.97 01.97 12.94 02.99 01.97	02.01 02.01 12.96 02.01 02.99	BAR20142			258 20,0 18,2 V L
	1.4 i.e. 1.4 i.e. T.Spark 1.6 i.e. 1.6 i.e. T.Spark 1.7 i.e. 16V 1.8 i.e. T.Spark 1.9 JTD 2.0 i.e. 16V 2.0 TD	66 76 76 88 77 66	12.94 01.97 12.94 01.97 12.94 01.97 02.99 10.95 12.94	12.96 + ABS 02.01 + ABS 12.96 + ABS 02.01 + ABS 12.96 02.01 02.01 + ABS 02.01 02.99 + ABS	BA2035		+ GG-Sättel <sup>1)</sup>	21103 14,4 /S LUC
	2.0 i.e. 16V		10.95	02.01 - 	BAR11119			240 11,0 9,2
	1.4 i.e. 1.6 i.e. 2.0 TD	66 76 66	12.94 12.94 12.94	12.96 - ABS 12.96 - ABS 12.96 - ABS	BAW2008			Rz 20,64
<b>ALFA ROMEO 147 (01-10)</b>								
	1.6 i 16V T.Spark 1.6 i 16V T.Spark 1.9 JTD 1.9 JTD 1.9 JTD 16V 1.9 JTDM 16V 1.9 JTDM 8V 2.0 i 16V T.Spark	77 88 74 85 88 110	01.01 06.03 01.01 11.02 07.05 07.05 01.01	10.10 VET: 3021489 - 10.10 10.10 10.10 10.10 10.10 10.10	BA2315			23289 19,3 +/WK ATE
	1.6 i 16V T.Spark 1.6 i 16V T.Spark 1.9 JTD 1.9 JTD 1.9 JTD 16V 1.9 JTDM 16V 1.9 JTDM 8V 2.0 i 16V T.Spark 3.2 GTA	77 88 74 85 88 110 184	01.01 01.01 06.03 01.01 11.02 07.05 07.05 01.01 02.03	10.10 10.10 10.10 10.10 10.10 10.10 10.10 10.10 10.10	BA2271			23517 16,3 /S LUC
<b>ALFA ROMEO 155 (92-97)</b>								
	1.7 T.S. 1.8T.S. 1.9 TD		04.93 05.92 03.93	12.97 12.97 12.97	BA2034			20833 17,1 +/WK/S LUC
	1.7 T.S. 1.8T.S. 1.9 TD 2.5 TD		04.93 05.92 03.93 04.93	12.97 12.97 12.97 12.97	BAR20142 BAR12127			258 20,0 18,2 V L 257 12,0 10,2
	2.0 i 16V Turbo Q4		11.92	12.97	BAR22147			284 22,0 20,2 V

<sup>1)</sup> + cast iron caliper / + pinza in ghisa / + étriers en fonte grise / + fundición gris-pinza

        									
<b>ALFA ROMEO 155 (92-97)</b>									
	2.5 TD 2.5 V6			03.93 05.92	12.97 12.97		BAR22147		284 22,0 20,2 V
	1.7 T.S. 1.8T.S. 1.9 TD 2.0 T.S. 2.0 i 16V Turbo Q4 2.5 TD 2.5 V6			04.93 05.92 03.93 05.92 11.92 03.93 05.92	12.97 12.97 12.97 12.97 12.97 12.97 12.97		BA2035	+ GG-Sättel <sup>1)</sup>	21103 14,4 /S LUC
<b>ALFA ROMEO 156 (97-05)</b>									
	1.9 JTD 16V 2.0 i 16V T.Spark 2.0 JTS 2.4 JTD 2.4 JTD 2.5 i V6	103 122 100 103		11.02 03.00 03.02 03.00 10.00 03.00	07.05 07.05 07.05 10.00 07.05 07.05		BA2315		23289 19,3 +/WK ATE
	1.6 i 16V T.Spark 1.8 i 16V T.Spark 1.9 JTD 1.9 JTD 16V 1.9 JTD 16V 2.0 i 16V T.Spark 2.0 JTS 2.4 JTD 2.4 JTD 2.4 JTD 2.4 JTD 2.5 i V6 3.2 GTA	  103 110  122 103 103 110 129		03.02 03.02 03.02 11.02 07.04 03.02 03.02 03.02 03.02 10.03 03.02 03.02	07.05 07.05 07.05 07.05 07.05 07.05 07.05 07.05 07.05 07.05 07.05 07.05		BA2271		23517 16,3 /S LUC
<b>ALFA ROMEO GT (04-10)</b>									
	1.8 TS 1.9 JTD 1.9 JTD 2.0 JTS	103 3286798 110 3286798 125 121 3286798			07.10 07.10 05.08 07.10 07.10		BA2315		23289 19,3 +/WK ATE
	1.8 TS 1.9 JTD 1.9 JTD 2.0 JTS 3.2 i V6	103 110 125 121 176		11.03 11.03 05.08 11.03 11.03	07.10 07.10 07.10 07.10 07.10		BA2271		23517 16,3 /S LUC
<b>ALFA ROMEO GTV (95-05)</b>									
	1.8 i 16V 2.0 i 16V 2.0 i V6 Turbo 2.0 JTS 3.0 i V6 3.2 i V6	106 148 121 176		04.98 05.95 05.95 04.03 10.96 04.03	12.05 12.05 12.05 12.05 12.05 12.05		BA2035	+ GG-Sättel <sup>1)</sup>	21103 14,4 /S LUC
<b>ALFA ROMEO MITO (08-)</b>									
	1.4 i 16V 1.4 i 16V	58 70		08.08 08.08			BA2283		23706 17,8 +/WK/S BOS
	0.9 1.4 i 16V 1.4 i 16V	63 58 70		07.11 08.08 08.08			BAR22197		258 22,0 20,2 V
	0.9 1.3 JTDM 1.3 JTDM 1.3 JTDM 1.4 1.4 Bifuel 1.4 i 16V 1.4 i 16V 1.4 TB 1.4 TB 1.4 TB 1.4 Turbo 1.6 JTD 1.6 JTDM	63 62 66 70 88 88 58 70 99 114 125 110 88 85		07.11 01.11 08.08 10.09 08.08 07.11 08.08 08.08 09.09 08.08 10.09 09.08 08.08 09.09			BA2303	+ Sonderbremszange	23714 16,3 /S BOS
<b>ALFA ROMEO SPIDER (95-05)</b>									
	1.8 i 16V 2.0 16V 2.0 i 16V 2.0 i V6 Turbo 2.0 JTS 3.0 i V6 3.0 V6 3.0 V6 24V 3.2 i V6	106 114 110 148 121 141 160 162 176		04.98 05.98 05.95 05.98 04.03 05.95 10.00 01.99 04.03	12.05 12.05 12.05 12.05 12.05 12.05 12.05 12.05 12.05		BA2035	+ GG-Sättel <sup>1)</sup>	21103 14,4 /S LUC

<sup>1)</sup> + cast iron caliper / + pinza in ghisa / + étriers en fonte grise / + fundición gris-pinza

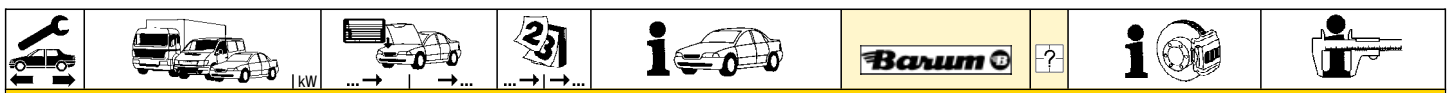























AUDI 80 (91-95)											
	1.6 1.9 TD 1.9 TDI 2.0 2.3 2.6	55		08.91 09.91 09.91 08.91 09.91 07.92	12.95 12.95 12.95 12.95 12.95 12.95		BA2031 BA2028		20669 19,6 /S 20901 19,6 +WK/S	LUC LUC	
	1.6 1.9 TD 1.9 TDI 2.0 2.0	51 55 66 85	8C-P-000001 8C-P-000001 8C-P-000001 8C-P-000001 8C-P-000001	08.91 09.91 09.91 08.91 08.91		+ Schaltgetriebe 1) + Schaltgetriebe 1)	BAR13166		256 13,0 11,0		
	1.6 2.0 2.0 2.0 2.3	74 66 85 101	8C-N-300000 8C-N-300000 8C-N-300000 8C-N-300000 8C-N-300000	08.91 08.91 08.91 08.91 09.91		+ Automatikgetriebe 2) + Automatikgetriebe 2)	BAR22108		256 22,0 20,0 V L		
	1.6 1.6 1.9 TD 2.0 2.0 2.0 2.0 2.0 2.3 2.6	51 74 55 66 85 101 103	8C-P-000001 8C-P-000001 8C-P-000001 8C-P-000001 8C-P-000001 8C-P-000001 8C-P-000001 8C-P-000001 8C-P-000001 8C-P-000001		12.95 12.95 12.95 12.95 07.92 12.95 12.95 08.92	+ Automatikgetriebe 2) + Automatikgetriebe 2) + Automatikgetriebe 2) + Automatikgetriebe 2)	BAR22139		280 21,9 20,0 V L		
	1.6 1.9 TD 1.9 TDI 2.0 2.3 2.6 2.8	55		08.91 09.91 09.91 08.91 09.91 07.92 09.91	12.95 12.95 12.95 12.95 12.95 12.95 12.95		BAH0012 BAH0003	2 2	am Bremsattel 3)	L=285 L=160	
	1.6 1.6 1.9 TD 1.9 TD 1.9 TDI 1.9 TDI 2.0 2.0 2.0 2.0 2.0 2.3 2.6 2.8		8C-P-050000 55 55 8C-P-050000 8C-P-050000 66 66 85 101 103	8C-P-050000 8C-P-050000 8C-P-050000 8C-P-050000 8C-P-050000 8C-P-050000 8C-P-050000 8C-P-050000 8C-P-050000 8C-P-050000 8C-P-050000 8C-P-050000 8C-P-050000 8C-P-050000	08.91 09.91 09.91 09.91 08.91 08.91 08.91 08.91 09.91 08.92 09.91	+ ABS + ABS + ABS + ABS	BA2052		21144 16,6 /S	LUC	
	1.6 1.6 1.9 TD 1.9 TD 1.9 TDI 1.9 TDI 2.0 2.0 2.0 2.0 2.0 2.3 2.6 2.8		8C-P-050000 55 55 8C-P-050000 8C-P-050000 66 66 85 101 103	8C-P-050000 8C-P-050000 8C-P-050000 8C-P-050000 8C-P-050000 8C-P-050000 8C-P-050000 8C-P-050000 8C-P-050000 8C-P-050000 8C-P-050000 8C-P-050000 8C-P-050000 8C-P-050000	08.91 09.91 09.91 09.91 08.91 08.91 08.91 08.91 09.91 08.92 09.91	+ ABS + ABS + ABS + ABS	BAR10178		245 9,9 8,0		
	1.6 1.9 TD	51 55	8C-P-050000 8C-P-050000	08.91 09.91		- ABS - ABS	BAW1701	+ GG 4)	Rz 17,46		
	1.6 1.9 TDI 2.0	74	8C-N-300000 8C-N-300000 8C-N-300000	08.91 08.91 08.91		- ABS - ABS - ABS	BAW1905		Rz 19,05		
	1.6 1.9 TDI 2.0	74	8C-P-000001 8C-P-000001 8C-P-000001	8C-P-050000 8C-P-050000 8C-P-050000		- ABS - ABS - ABS	BAW2004		Rz 20,64		
		1.6 1.9 TD 1.9 TDI 2.0	55	8C-P-050000 8C-P-050000 8C-P-050000 8C-P-050000	08.91 08.91 09.91 08.91		- ABS - ABS - ABS - ABS	BAE5006		230 x 40 HEB	VW























**AUDI 80 Quattro (92-95)**

	2.0 2.3 2.6			09.91 09.91 08.92	12.95 12.95 12.95		BA2031		20669 19,6 /S	LUC
	2.0 2.3		8C-N-300000 8C-N-300000	09.91 09.91			BAR22108		256 22,0 20,0 V L	
	2.0 2.3 2.6	8C-P-000001 8C-P-000001			12.95 12.95 08.92		BAR22139		280 21,9 20,0 V L	

1) + manual transmission / + scatola cambio velocità / + transmission mécanique / + cambio de velocidad  
 2) + autom.transmission / + scatola cambio automatico / + transmission automatique / + cambio automático  
 3) on the brake caliper / sulla pinza freno / sur l'étrier de frein / a la pinza de freno  
 4) + cast iron / + ghisa / + fonte grise / + fundición de gris

								
<b>AUDI 80 Quattro (92-95)</b>								
	2.0 2.3 2.6 2.8 RS2 2.2 S2 2.2	232 169	09.91 09.91 08.92 09.91 03.94 02.93	12.95 12.95 12.95 12.95 07.95 12.95	BAH0012 BAH0003	2 2	am Bremssattel <sup>1)</sup>	L=285 L=160
	2.0 2.3 2.6 2.8 S2 2.2	169	09.91 09.91 08.92 09.91 02.93	12.95 12.95 12.95 12.95 12.95	BA2052			21144 16,6 / S LUC
	S2 2.2	169	02.93	12.95	BAR10261			245 10,0 8,0
<b>AUDI 100 (91-94)</b>								
	1.6 2.0 2.0 16V 2.3 2.4 D 2.5 TDI 2.6 2.8		03.92 12.90 01.92 12.90 05.91 06.91 04.92 12.90	07.93 07.94 07.94 07.94 07.94 07.94 07.94 07.94	BA2135			20678 19,5 +/WK ATE
	1.6 2.0 2.0 16V 2.3 2.4 D 2.5 TDI		03.92 12.90 01.92 12.90 05.91 06.91	07.93 07.94 07.94 07.94 07.94 07.94	BAR15105			288 15,0 13,0 L
	2.6 2.8		04.92 12.90	07.94 07.94	BAR25105			288 24,8 23,0 V L
	1.6 2.0 2.0 16V 2.3 2.4 D 2.5 TDI 2.6 2.8		03.92 12.90 01.92 12.90 05.91 06.91 04.92 12.90	07.93 07.94 07.94 07.94 07.94 07.94 07.94 07.94	BAH0026	2		L=270
	1.6 2.0 2.0 16V 2.3 2.4 D 2.4 D 2.5 TDI 2.6 2.8		03.92 12.90 07.93 12.90 05.91 07.93 06.91 04.92 12.90	07.93 + ABS 06.93 + ABS 07.94 07.94 06.93 + ABS 07.94 07.94 07.94 07.94	BA2052			21144 16,6 / S LUC
	1.6 2.0 2.0 16V 2.3 2.4 D 2.4 D 2.5 TDI 2.6 2.8		03.92 12.90 07.93 01.92 12.90 05.91 07.93 06.91 04.92 12.90	07.93 + ABS 06.93 + ABS 07.94 07.94 06.93 + ABS 07.94 07.94 07.94 07.94	BAR10201			245 9,9 8,0
	1.6 2.0 2.0 2.4 D	74 85	03.92 12.90 12.90 05.91	07.93 - ABS 06.93 - ABS 06.93 - ABS 06.93 - ABS	BAH0015	2		L=180
	1.6 2.0 2.0 2.0 2.0 2.0 16V 2.3 2.4 D 2.4 D 2.5 TDI 2.6 2.8	74 74 85 85	03.92 12.90 07.93 12.90 07.93 01.92 12.90 05.91 07.93 06.91 04.92 12.90	07.93 + ABS 06.93 + ABS 07.94 06.93 + ABS 07.94 07.94 06.93 + ABS 07.94 07.94 07.94 07.94	BAH0015	2		L=180
	1.6 2.0 2.0 2.4 D	74 85	03.92 12.90 12.90 05.91	07.93 - ABS 07.93 - ABS 07.93 - ABS 07.93 - ABS	BAW2004			Rz 20,64
	1.6 2.0 2.0 2.4 D	74 85	03.92 12.90 12.90 05.91	07.93 - ABS 07.93 - ABS 07.93 - ABS 07.93 - ABS	BAE5006			230 x 40 HEB VW







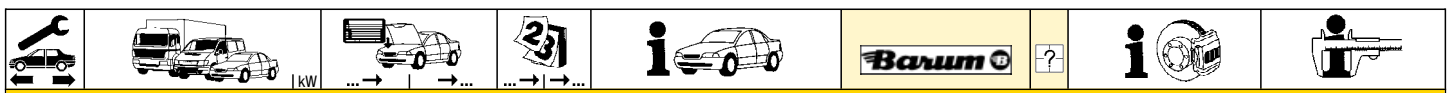







<sup>1)</sup> on the brake caliper / sulla pinza freno / sur l'étrier de frein / a la pinza de freno

	   kW							
<b>AUDI 100 Quattro (91-94)</b>								
	2.0 2.3 2.6 2.8		12.90 12.90 03.92 12.90	07.94 07.94 07.94 07.94	BA2135			20678 19,5 +/WK ATE
	2.0 2.3 2.6 2.8		12.90 12.90 03.92 12.90	07.94 07.94 07.94 07.94	BAR15105 BAR25105			288 15,0 13,0 L 288 24,8 23,0 V L
	2.0 2.3 2.6 2.8 S4 2.2 S4 4.2	169	12.90 12.90 03.92 12.90 08.91 10.92	07.94 07.94 07.94 07.94 07.94 07.94	BAH0026	2		L=270
	2.0 2.3 2.6 2.8 S4 2.2 S4 4.2	169	12.90 12.90 03.92 07.92 08.91 10.92	07.94 07.94 07.94 07.94 07.94 07.94	BA2052			21144 16,6 /S LUC
	2.0 2.3 2.6 2.8		12.90 12.90 03.92 12.90	07.94 07.94 07.94 07.94	BAR10201			245 9,9 8,0
<b>AUDI A1 / A1 Sportback (10-)</b>								
	1.2 TFSI 1.4 TFSI 1.4 TFSI 1.4 TFSI 1.6 TDI 1.6 TDI 2.0 TDI 2.0 TFSI quattro	63 90 103 136 66 77 105 188	05.10 05.10 04.12 11.10 05.10 05.10 09.11 10.12	PR: 1ZG PR: 1ZG PR: 1ZG PR: 1ZG PR: 1ZG PR: 1ZG PR: 1ZG PR: 1ZG	BA2154			23130 19,6 + VW
	1.2 TFSI 1.4 TFSI 1.4 TFSI 1.4 TFSI 1.6 TDI 1.6 TDI 2.0 TDI 2.0 TFSI quattro	63 90 103 136 66 77 105 188	05.10 05.10 04.12 11.10 05.10 05.10 09.11 10.12	PR: 1ZC PR: 1ZC PR: 1ZC PR: 1ZC PR: 1ZC PR: 1ZC PR: 1ZC PR: 1ZC	BA2195			23587 19,6 +/WK ATE
	1.2 TFSI 1.4 TFSI 1.4 TFSI 1.4 TFSI 1.6 TDI 1.6 TDI 2.0 TDI 2.0 TFSI quattro	63 90 103 136 66 77 105 188	05.10 05.10 04.12 11.10 05.10 05.10 09.11 10.12	PR: 1ZG PR: 1ZG PR: 1ZG PR: 1ZG PR: 1ZG PR: 1ZG PR: 1ZG PR: 1ZG	BAR22151			256 22,0 19,0 V L
	1.2 TFSI 1.4 TFSI 1.4 TFSI 1.4 TFSI 1.6 TDI 1.6 TDI 2.0 TDI 2.0 TFSI quattro	63 90 103 136 66 77 105 188	05.10 05.10 04.12 11.10 05.10 05.10 09.11 10.12	PR: 1ZC PR: 1ZC PR: 1ZC PR: 1ZC PR: 1ZC PR: 1ZC PR: 1ZC PR: 1ZC	BAR25113			288 25,0 22,0 V L
	1.2 TFSI 1.4 TFSI 1.4 TFSI 1.4 TFSI 1.6 TDI 1.6 TDI 2.0 TDI 2.0 TFSI quattro	63 90 103 136 66 77 105 188	05.10 05.10 04.12 11.10 05.10 05.10 09.11 10.12	PR: 1LJ PR: 1LJ PR: 1LJ PR: 1LJ PR: 1LJ PR: 1LJ PR: 1LJ PR: 1LJ	BAR25158			312 25,0 22,0 V L
	1.2 TFSI 1.4 TFSI 1.4 TFSI 1.4 TFSI 1.6 TDI 1.6 TDI 2.0 TDI 2.0 TFSI quattro	63 90 103 136 66 77 105 188	05.10 05.10 04.12 11.10 05.10 05.10 09.11 10.12	PR: 1KT PR: 1KT PR: 1KT PR: 1KT PR: 1KT PR: 1KT PR: 1KT PR: 1KT	BA2017			20961 17,2 /S LUC
	1.2 TFSI 1.4 TFSI 1.4 TFSI 1.4 TFSI 1.6 TDI 1.6 TDI	63 90 136 66 77	05.10 05.10 11.10 05.10 05.10	PR: 1KT PR: 1KT PR: 1KT PR: 1KT PR: 1KT	BAH0033	2		L=140
	1.2 TFSI 1.4 TFSI 1.4 TFSI 1.4 TFSI 1.6 TDI 1.6 TDI	63 90 103 136 66 77	06.11 06.11 04.12 06.11 06.11 06.11	PR: 1KT PR: 1KT PR: 1KT PR: 1KT PR: 1KT PR: 1KT	BAH0033	2		L=140



















AUDI A1 / A1 Sportback (10-)									
	2.0 TDI 2.0 TFSI quattro	105 188		09.11 10.12	PR: 1KT PR: 1KT	BAH0033	2		L=140
AUDI A2 (00-05)									
	1.4 1.4 TDI 1.4 TDI 1.6 FSI	55 55 66 81		06.00 06.00 11.03 05.02	07.05 07.05 07.05 07.05	BA2155			23131 19,6 +/WK VW
	1.4 1.4 TDI 1.4 TDI 1.6 FSI	55 55 66 81		06.00 06.00 11.03 05.02	07.05 07.05 07.05 07.05	BAR22151			256 22,0 19,0 V L
	1.4 TDI 1.6 FSI	66 81		11.03 05.02	07.05 07.05	BA2017 BA2032			20961 17,2 /S 20961 15,2 /S LUC LUC
	1.4 TDI 1.6 FSI	66 81		11.03 05.02	07.05 07.05	BAR09123			232 8,9 7,0
	1.2 TDI 1.4 TDI	45 55		03.01 06.00	07.05 07.05	PR: 1KR PR: 1KR BAW1501			Rz 15,87
	1.4 1.4 TDI	55 55		06.00 06.00	07.05 07.05	PR: 1KB PR: 1KB BAW1701			Rz 17,46
	1.4 1.4 TDI	55 55		06.00 06.00	07.05 07.05	PR: 1KB PR: 1KB BAE5001			200 x 40 HEB VW
AUDI A3 (96-03)									
	1.6 1.8 1.8 Quattro 1.8 T 1.8 T 1.8 T Quattro 1.8 T Quattro 1.9 TDI 1.9 TDI	75 92 92 110 132 110 132 66 81	8L-X-200000 8L-X-200000 8L-X-200000 8L-X-200000 8L-X-200000 8L-X-200000 8L-X-200000 8L-X-200000 8L-X-200000	09.96 09.96 08.98 12.96 12.98 08.98 10.98 09.96 03.97	PR: 1LQ,1LR,1LS PR: 1LQ,1LR,1LS PR: 1LQ,1LR,1LS PR: 1LQ,1LR,1LS PR: 1LQ,1LR,1LS PR: 1LQ,1LR,1LS PR: 1LQ,1LR,1LS PR: 1LQ,1LR,1LS PR: 1LQ,1LR,1LS	BA2154			23130 19,6 + VW
	1.6 1.8 1.8 Quattro 1.8 T 1.8 T 1.8 T Quattro 1.8 T Quattro 1.9 TDI 1.9 TDI S3 Quattro	75 92 92 110 132 110 132 66 74 81 96 96	8L-X-150000 8L-X-150000 8L-X-150000 8L-X-150000 8L-X-150000 8L-X-150000 8L-X-150000 8L-X-150000 8L-X-150000 8L-X-150000 8L-X-200000	09.96 09.96 08.98 12.96 12.98 08.98 10.98 09.96 03.97 08.98	PR: 1LE,1LN,1ZD PR: 1LE,1LN,1ZD PR: 1LE,1LN,1ZD PR: 1LE,1LN,1ZD PR: 1LE,1LN,1ZD PR: 1LE,1LN,1ZD PR: 1LE,1LN,1ZD PR: 1LE,1LN,1ZD PR: 1LE,1LN,1ZD PR: 1LE,1LN,1ZD PR: 1LT	BA2333			21911 20,3 + ATE
	1.6 1.8 1.8 Quattro 1.8 T 1.8 T 1.8 T Quattro 1.8 T Quattro 1.9 TDI 1.9 TDI 1.9 TDI 1.9 TDI Quattro S3 Quattro	75 92 92 110 132 110 132 66 74 81 96 96	8L-Y-000001 8L-Y-000001 8L-Y-000001 8L-Y-000001 8L-Y-000001 8L-Y-000001 8L-Y-000001 8L-Y-000001 8L-Y-000001 8L-Y-000001 8L-Y-000001 8L-Y-000001	06.03 06.03 06.03 06.03 06.03 06.03 06.03 09.00 06.01 09.00 09.00 06.03	PR: 1LE,1LN,1ZD PR: 1LE,1LN,1ZD PR: 1LE,1LN,1ZD PR: 1LE,1LN,1ZD PR: 1LE,1LN,1ZD PR: 1LE,1LN,1ZD PR: 1LE,1LN,1ZD PR: 1LE,1LN,1ZD PR: 1LE,1LN,1ZD PR: 1LE,1LN,1ZD PR: 1LE,1LN,1ZD PR: 1LT	BA2205			23392 20,6 +/WK ATE
	1.6 1.8 1.8 Quattro 1.8 T 1.8 T 1.8 T Quattro 1.8 T Quattro 1.9 TDI 1.9 TDI 1.9 TDI 1.9 TDI Quattro	75 92 92 110 132 110 132 66 74 81 96 96		09.96 09.96 08.98 12.96 12.98 08.98 10.98 09.96 09.00 03.97 09.00 09.00	PR: 1LQ PR: 1LQ PR: 1LQ PR: 1LQ PR: 1LQ PR: 1LQ PR: 1LQ PR: 1LQ PR: 1LQ PR: 1LQ PR: 1LQ	BAR22151			256 22,0 19,0 V L
	1.6 1.8 1.8 Quattro 1.8 T 1.8 T 1.8 T Quattro 1.8 T Quattro 1.9 TDI 1.9 TDI 1.9 TDI 1.9 TDI Quattro	75 92 92 110 132 110 132 66 74 81 96 96		09.96 09.96 08.98 12.96 12.98 08.98 10.98 09.96 09.00 03.97 09.00 09.00	PR: 1LR,1LS,1ZP PR: 1LR,1LS,1ZP PR: 1LR,1LS,1ZP PR: 1LR,1LS,1ZP PR: 1LR,1LS,1ZP PR: 1LR,1LS,1ZP PR: 1LR,1LS,1ZP PR: 1LR,1LS,1ZP PR: 1LR,1LS,1ZP PR: 1LR,1LS,1ZP PR: 1LR,1LS,1ZP	BAR22150			280 22,0 19,0 V L
	1.6	75		09.96	06.03	PR: 1LE,1LN,1ZD			288 25,0 22,0 V L

									
<b>AUDI A3 (96-03)</b>									
	1.8 1.8 Quattro 1.8 T 1.8 T 1.8 T Quattro 1.8 T Quattro 1.9 TDI 1.9 TDI 1.9 TDI 1.9 TDI 1.9 TDI Quattro	92 92 110 132 110 132 66 74 81 96 96		09.96 08.98 12.96 12.98 08.98 10.98 09.96 09.00 03.97 09.00 09.00	06.03 06.03 06.03 06.03 06.03 06.03 06.01 06.03 06.01 06.03 06.03	PR: 1LE,1LN,1ZD PR: 1LE,1LN,1ZD PR: 1LE,1LN,1ZD PR: 1LE,1LN,1ZD PR: 1LE,1LN,1ZD PR: 1LE,1LN,1ZD PR: 1LE,1LN,1ZD PR: 1LE,1LN,1ZD PR: 1LE,1LN,1ZD PR: 1LE,1LN,1ZD PR: 1LE,1LN,1ZD	BAR25113		288 25,0 22,0 V L
	S3 Quattro		08.98	06.03	PR: 1LT	BAR25123			312 25,0 23,0 V L
	1.6 1.8 1.8 T 1.8 T 1.9 TDI 1.9 TDI 1.9 TDI 1.9 TDI	75 92 110 132 66 74 81 96		09.96 09.96 12.96 12.98 09.96 09.00 03.97 09.00	06.03 06.03 06.03 06.03 06.01 06.03 06.01 06.03		BAH0023	2	L=435
	1.6 1.8 1.8 Quattro 1.8 T 1.8 T 1.8 T Quattro 1.8 T Quattro 1.9 TDI 1.9 TDI 1.9 TDI 1.9 TDI 1.9 TDI Quattro S3 Quattro	75 92 92 110 132 110 132 66 74 81 96 96		09.96 09.96 08.98 12.96 12.98 08.98 10.98 09.96 09.00 03.97 09.00 09.00 08.98	06.03 06.03 06.03 06.03 06.03 06.03 06.03 06.01 06.03 06.01 06.03 06.03 06.03	PR: 1KK,1KV,1KE PR: 1KK,1KV,1KE PR: 1KK,1KV,1KE PR: 1KK,1KV,1KE PR: 1KK,1KV,1KE PR: 1KK,1KV,1KE PR: 1KK,1KV,1KE PR: 1KK,1KV,1KE PR: 1KK,1KV,1KE PR: 1KK,1KV,1KE PR: 1KK,1KV,1KE PR: 1KK,1KV,1KE PR: 1KF	BA2017 BA2032		20961 17,2 /S 20961 15,2 /S LUC LUC
	1.6 1.8 1.8 T 1.8 T 1.9 TDI 1.9 TDI 1.9 TDI 1.9 TDI	75 92 110 132 66 74 81 96		09.96 09.96 12.96 12.98 09.96 09.00 03.97 09.00	06.03 06.03 06.03 06.03 06.01 06.03 06.01 06.03	PR: 1KK,1KV PR: 1KK,1KV PR: 1KK,1KV PR: 1KK,1KV PR: 1KK,1KV PR: 1KK,1KV PR: 1KK,1KV PR: 1KK,1KV	BAR09123		232 8,9 7,0
	1.8 Quattro 1.8 T Quattro 1.8 T Quattro 1.9 TDI Quattro	92 110 132 96		08.98 08.98 10.98 09.00	06.03 06.03 06.03 06.03	PR: 1KE PR: 1KE PR: 1KE PR: 1KE	BAR09133		239 8,9 7,0
	S3 Quattro		08.98	06.03	PR: 1KF	BAR22163			256 22,0 20,0 V L
	1.6 1.8 1.8 T 1.8 T 1.9 TDI 1.9 TDI 1.9 TDI 1.9 TDI	75 92 110 132 66 74 81 96		09.96 09.96 12.96 12.98 09.96 09.00 03.97 09.00	06.03 06.03 06.03 06.03 06.01 06.03 06.01 06.03		BAH0033	2	L=140
	1.8 Quattro 1.8 T Quattro 1.8 T Quattro 1.9 TDI Quattro S3 Quattro	92 110 132 96		08.98 08.98 10.98 09.00 08.98	06.03 06.03 06.03 06.03 06.03		BAH0033	2	L=140
<b>AUDI A3 / A3 Sportback (03-)</b>									
	1.2 TSI 1.4 TFSI 1.6 1.6 FSI 1.6 TDI 1.6 TDI 1.8 TFSI 1.8 TFSI quattro 1.9 TDI 2.0 FSI 2.0 TDI 2.0 TDI 2.0 TDI 2.0 TDI 2.0 TDI quattro 2.0 TDI quattro 2.0 TDI quattro 2.0 TFSI 2.0 TFSI quattro 3.2 quattro	77 92 75 85 66 77 118 118 77 110 100 103 120 125 100 103 125 147 147 184		04.10 07.07 05.03 08.03 05.09 05.09 01.07 05.08 06.03 05.03 05.03 05.03 06.06 03.06 05.03 08.04 03.06 06.04 06.04 03.06		PR: 1ZF,1ZM PR: 1ZF,1ZM PR: 1ZF,1ZM PR: 1ZF,1ZM PR: 1ZF,1ZM PR: 1ZF,1ZM PR: 1ZF,1ZM PR: 1ZF,1ZM PR: 1ZF,1ZM PR: 1ZF,1ZM PR: 1ZF,1ZM PR: 1ZF,1ZM PR: 1ZF,1ZM PR: 1ZF,1ZM PR: 1ZF,1ZM PR: 1ZF,1ZM PR: 1ZF,1ZM PR: 1ZF,1ZM PR: 1ZF,1ZM PR: 1ZF,1ZM	BA2155		23131 19,6 +/WK VW
	1.2 TSI 1.4 TFSI 1.6 1.6 FSI 1.6 TDI	77 92 75 85 66		04.10 07.07 05.03 08.03 05.09		PR: 1ZE,1ZP,1ZD,1LJ,1ZA PR: 1ZE,1ZP,1ZD,1LJ,1ZA PR: 1ZE,1ZP,1ZD,1LJ,1ZA PR: 1ZE,1ZP,1ZD,1LJ,1ZA PR: 1ZE,1ZP,1ZD,1LJ,1ZA	BA2195		23587 19,6 +/WK ATE

**AUDI A3 / A3 Sportback (03-)**

	1.6 TDI 77 1.8 TFSI 118 1.8 TFSI quattro 118 1.9 TDI 77 2.0 FSI 110 2.0 TDI 100 2.0 TDI 103 2.0 TDI 120 2.0 TDI 125 2.0 TDI quattro 100 2.0 TDI quattro 103 2.0 TDI quattro 125 2.0 TFSI 147 2.0 TFSI quattro 147 3.2 quattro 184		05.09 01.07 05.08 06.03 05.03 05.03 06.06 03.06 05.03 08.04 03.06 06.04 06.04 03.06	PR: 1ZE,1ZP,1ZD,1LJ,1ZA PR: 1ZE,1ZP,1ZD,1LJ,1ZA PR: 1ZE,1ZP,1ZD,1LJ,1ZA PR: 1ZE,1ZP,1ZD,1LJ,1ZA PR: 1ZE,1ZP,1ZD,1LJ,1ZA PR: 1ZE,1ZP,1ZD,1LJ,1ZA PR: 1ZE,1ZP,1ZD,1LJ,1ZA PR: 1ZE,1ZP,1ZD,1LJ,1ZA PR: 1ZE,1ZP,1ZD,1LJ,1ZA PR: 1ZE,1ZP,1ZD,1LJ,1ZA PR: 1ZE,1ZP,1ZD,1LJ,1ZA PR: 1ZE,1ZP,1ZD,1LJ,1ZA PR: 1ZE,1ZP,1ZD,1LJ,1ZA PR: 1ZE,1ZP,1ZD,1LJ,1ZA PR: 1ZE,1ZP,1ZD,1LJ,1ZA	BA2195		23587 19,6 +WK	ATE
	1.2 TSI 77 1.4 TFSI 92 1.6 75 1.6 FSI 85 1.6 TDI 66 1.6 TDI 77 1.8 TFSI 118 1.8 TFSI quattro 118 1.9 TDI 77 2.0 FSI 110 2.0 TDI 100 2.0 TDI 103 2.0 TDI 120 2.0 TDI 125 2.0 TDI quattro 100 2.0 TDI quattro 103 2.0 TDI quattro 125 2.0 TFSI 147 2.0 TFSI quattro 147 3.2 quattro 184		04.10 07.07 05.03 08.03 05.09 05.09 01.07 05.08 06.03 05.03 05.03 06.06 03.06 05.03 08.04 03.06 06.04 06.04 03.06	PR: 1ZF,1ZM PR: 1ZF,1ZM PR: 1ZF,1ZM PR: 1ZF,1ZM PR: 1ZF,1ZM PR: 1ZF,1ZM PR: 1ZF,1ZM PR: 1ZF,1ZM PR: 1ZF,1ZM PR: 1ZF,1ZM PR: 1ZF,1ZM PR: 1ZF,1ZM PR: 1ZF,1ZM PR: 1ZF,1ZM PR: 1ZF,1ZM PR: 1ZF,1ZM PR: 1ZF,1ZM PR: 1ZF,1ZM PR: 1ZF,1ZM	BAR22210		280 22,0 19,0 V L	
	1.2 TSI 77 1.4 TFSI 92 1.6 75 1.6 FSI 85 1.6 TDI 66 1.6 TDI 77 1.8 TFSI 118 1.8 TFSI quattro 118 1.9 TDI 77 2.0 FSI 110 2.0 TDI 100 2.0 TDI 103 2.0 TDI 120 2.0 TDI 125 2.0 TDI quattro 100 2.0 TDI quattro 103 2.0 TDI quattro 125 2.0 TFSI 147 2.0 TFSI quattro 147 3.2 quattro 184		04.10 07.07 05.03 08.03 05.09 05.09 01.07 05.08 06.03 05.03 05.03 06.06 03.06 05.03 08.04 03.06 06.04 06.04 07.03	PR: 1ZE,1ZP PR: 1ZE,1ZP PR: 1ZE,1ZP PR: 1ZE,1ZP PR: 1ZE,1ZP PR: 1ZE,1ZP PR: 1ZE,1ZP PR: 1ZE,1ZP PR: 1ZE,1ZP PR: 1ZE,1ZP PR: 1ZE,1ZP PR: 1ZE,1ZP PR: 1ZE,1ZP PR: 1ZE,1ZP PR: 1ZE,1ZP PR: 1ZE,1ZP PR: 1ZE,1ZP PR: 1ZE,1ZP	BAR25145		288 24,9 22,0 V L	
	1.2 TSI 77 1.4 TFSI 92 1.6 75 1.6 FSI 85 1.6 TDI 66 1.6 TDI 77 1.8 TFSI 118 1.8 TFSI quattro 118 1.9 TDI 77 2.0 FSI 110 2.0 TDI 100 2.0 TDI 103 2.0 TDI 120 2.0 TDI 125 2.0 TDI quattro 100 2.0 TDI quattro 103 2.0 TDI quattro 125 2.0 TFSI 147 2.0 TFSI quattro 147 3.2 quattro 184		04.10 07.07 05.03 08.03 05.09 05.09 01.07 05.08 06.03 05.03 05.03 06.06 03.06 05.03 08.04 03.06 06.04 06.04 07.03	PR: 1ZD,1LJ,1ZA PR: 1ZD,1LJ,1ZA PR: 1ZD,1LJ,1ZA PR: 1ZD,1LJ,1ZA PR: 1ZD,1LJ,1ZA PR: 1ZD,1LJ,1ZA PR: 1ZD,1LJ,1ZA PR: 1ZD,1LJ,1ZA PR: 1ZD,1LJ,1ZA PR: 1ZD,1LJ,1ZA PR: 1ZD,1LJ,1ZA PR: 1ZD,1LJ,1ZA PR: 1ZD,1LJ,1ZA PR: 1ZD,1LJ,1ZA PR: 1ZD,1LJ,1ZA PR: 1ZD,1LJ,1ZA PR: 1ZD,1LJ,1ZA PR: 1ZD,1LJ,1ZA	BAR25158		312 25,0 22,0 V L	
	1.2 TSI 77 1.4 TFSI 92 1.6 75 1.6 FSI 85 1.6 TDI 66 1.6 TDI 77 1.8 TFSI 118 1.9 TDI 77 2.0 FSI 110 2.0 TDI 100 2.0 TDI 103 2.0 TDI 120 2.0 TDI 125 2.0 TDI quattro 100 2.0 TDI quattro 103 2.0 TDI quattro 125 2.0 TFSI 147 2.0 TFSI quattro 147 3.2 quattro 184		04.10 07.07 05.03 08.03 05.09 05.09 01.07 06.03 05.03 05.03 05.03 06.06 03.06 05.03 08.04 03.06 06.04 06.04 07.03	PR: 1KQ,1KD PR: 1KQ,1KD PR: 1KQ,1KD PR: 1KQ,1KD PR: 1KQ,1KD PR: 1KQ,1KD PR: 1KQ,1KD PR: 1KQ,1KD PR: 1KQ,1KD PR: 1KQ,1KD PR: 1KQ,1KD PR: 1KQ,1KD PR: 1KQ,1KD PR: 1KQ,1KD PR: 1KQ,1KD PR: 1KQ,1KD PR: 1KQ,1KD PR: 1KQ,1KD	BA2017		20961 17,2 /S	LUC
↓	↓		06.06	06.08 PR: 1KQ,1KD				

	   kW							
<b>AUDI A3 / A3 Sportback (03-)</b>								
	2.0 TDI	125	03.06	PR: 1KQ,1KD	BA2017			20961 17,2 /S LUC
	2.0 TFSI	147	06.04	PR: 1KQ,1KD				
	1.2 TSI	77	04.10	PR: 1KE,1KZ	BA2196			23914 16,3 /WE/S LUC
	1.4 TFSI	92	07.07	PR: 1KE,1KZ				
	1.6	75	05.03	PR: 1KE,1KZ				
	1.6 FSI	85	08.03	PR: 1KE,1KZ				
	1.6 TDI	66	05.09	PR: 1KE,1KZ				
	1.6 TDI	77	05.09	PR: 1KE,1KZ				
	1.8 TFSI	118	01.07	PR: 1KE,1KZ				
	1.8 TFSI quattro	118	05.08	PR: 1KJ				
	1.9 TDI	77	06.03	PR: 1KE,1KZ				
	2.0 FSI	110	05.03	PR: 1KE,1KZ				
	2.0 TDI	100	05.03	PR: 1KE,1KZ				
	2.0 TDI	103	05.03	PR: 1KE,1KZ				
	2.0 TDI	120	06.06	06.08 PR: 1KE,1KZ				
	2.0 TDI	120	06.06	06.08 PR: 1KF,1KJ,1KU				
	2.0 TDI	125	03.06	PR: 1KE,1KZ				
	2.0 TDI quattro	100	05.03	PR: 1KF,1KJ,1KU				
2.0 TDI quattro	103	08.04	PR: 1KF,1KJ,1KU					
2.0 TDI quattro	125	03.06	PR: 1KF,1KJ,1KU					
2.0 TFSI	147	06.04	PR: 1KE,1KZ					
2.0 TFSI quattro	147	06.04	PR: 1KF,1KJ,1KU					
3.2 quattro	184	07.03	PR: 1KJ					
3.2 quattro	184	07.03	PR: 2EA	BA2196			23914 16,3 /WE/S LUC	
RS 3 quattro	250	04.11						
S3 quattro	188	07.08	PR: 1KW					
S3 quattro	195	11.06	PR: 1KW					
	1.2 TSI	77	04.10	PR: 1KZ	BAR12169			282 12,0 10,0
	1.4 TFSI	92	07.07	PR: 1KZ				
	1.6	75	05.03	PR: 1KZ				
	1.6 FSI	85	08.03	PR: 1KZ				
	1.6 TDI	66	05.09	PR: 1KZ				
	1.6 TDI	77	05.09	PR: 1KZ				
	1.8 TFSI	118	01.07	PR: 1KZ				
	1.8 TFSI quattro	118	05.08	PR: 1KJ				
	1.9 TDI	77	06.03	PR: 1KZ				
	2.0 FSI	110	05.03	PR: 1KZ				
	2.0 TDI	100	05.03	PR: 1KZ				
	2.0 TDI	103	05.03	PR: 1KZ				
	2.0 TDI	120	06.06	06.08 PR: 1KZ				
	2.0 TDI	120	06.06	06.08 PR: 1KJ,1KU				
	2.0 TDI	125	03.06	PR: 1KZ				
	2.0 TDI quattro	100	05.03	PR: 1KJ,1KU				
	2.0 TDI quattro	103	08.04	PR: 1KJ,1KU				
	2.0 TDI quattro	125	03.06	PR: 1KJ,1KU				
	2.0 TFSI	147	06.04	PR: 1KZ				
	2.0 TFSI quattro	147	06.04	PR: 1KJ,1KU				
	3.2 quattro	184	07.03	PR: 1KJ				
	1.2 TSI	77	04.10	PR: 1KE	BAR12158			256 12,0 10,0
	1.4 TFSI	92	07.07	PR: 1KE				
	1.6	75	05.03	PR: 1KE				
1.6 FSI	85	08.03	PR: 1KE					
1.6 TDI	66	05.09	PR: 1KE					
1.6 TDI	77	05.09	PR: 1KE					
1.8 TFSI	118	01.07	PR: 1KE					
1.9 TDI	77	06.03	PR: 1KE					
2.0 FSI	110	05.03	PR: 1KE					
2.0 TDI	100	05.03	PR: 1KE					
2.0 TDI	103	05.03	PR: 1KE					
2.0 TDI	120	06.06	06.08 PR: 1KE					
2.0 TDI	120	06.06	06.08 PR: 1KF					
2.0 TDI	125	03.06	PR: 1KE					
2.0 TDI quattro	100	05.03	PR: 1KF					
2.0 TDI quattro	103	08.04	PR: 1KF					
2.0 TDI quattro	125	03.06	PR: 1KF					
2.0 TFSI	147	06.04	PR: 1KE					
2.0 TFSI quattro	147	06.04	PR: 1KF					
<b>AUDI A3 Cabrio (08-)</b>								
	1.2 TSI	77	03.10	PR: 1ZF	BA2155			23131 19,6 +/WK VW
	1.4 TFSI	92	01.11	PR: 1ZF				
	1.6	75	09.08	PR: 1ZF				
	1.6 TDI	77	05.09	PR: 1ZF				
	1.8 TFSI	118	04.08	PR: 1ZF				
	1.9 TDI	77	04.08	PR: 1ZF				
	2.0 TDI	100	04.08	PR: 1ZF				
	2.0 TDI	103	04.08	PR: 1ZF				
	2.0 TFSI	147	04.08	PR: 1ZF				
	1.2 TSI	77	03.10	PR: 1LJ,1ZE	BA2195			23587 19,6 +/WK ATE
1.4 TFSI	92	01.11	PR: 1LJ,1ZE					
1.6	75	09.08	PR: 1LJ,1ZE					
1.6 TDI	77	05.09	PR: 1LJ,1ZE					
1.8 TFSI	118	04.08	PR: 1LJ,1ZE					
1.9 TDI	77	04.08	PR: 1LJ,1ZE					
2.0 TDI	100	04.08	PR: 1LJ,1ZE					
2.0 TDI	103	04.08	PR: 1LJ,1ZE					
2.0 TFSI	147	04.08	PR: 1LJ,1ZE					

**AUDI A3 Cabrio (08-)**

	1.2 TSI	77	03.10	PR: 1ZF	BAR22210		280 22,0 19,0 V L
	1.4 TFSI	92	01.11	PR: 1ZF			
	1.6	75	09.08	PR: 1ZF			
	1.6 TDI	77	05.09	PR: 1ZF			
	1.8 TFSI	118	04.08	PR: 1ZF			
	1.9 TDI	77	04.08	PR: 1ZF			
	2.0 TDI	100	04.08	PR: 1ZF			
	2.0 TDI	103	04.08	PR: 1ZF			
	2.0 TFSI	147	04.08	PR: 1ZF			
	1.2 TSI	77	03.10	PR: 1ZE	BAR25145		288 24,9 22,0 V L
	1.4 TFSI	92	01.11	PR: 1ZE			
	1.6	75	09.08	PR: 1ZE			
	1.6 TDI	77	05.09	PR: 1ZE			
	1.8 TFSI	118	04.08	PR: 1ZE			
	1.9 TDI	77	04.08	PR: 1ZE			
	2.0 TDI	100	04.08	PR: 1ZE			
	2.0 TDI	103	04.08	PR: 1ZE			
	2.0 TFSI	147	04.08	PR: 1ZE			
	1.2 TSI	77	03.10	PR: 1LJ	BAR25158		312 25,0 22,0 V L
	1.4 TFSI	92	01.11	PR: 1LJ			
	1.6	75	09.08	PR: 1LJ			
	1.6 TDI	77	05.09	PR: 1LJ			
	1.8 TFSI	118	04.08	PR: 1LJ			
	1.9 TDI	77	04.08	PR: 1LJ			
	2.0 TDI	100	04.08	PR: 1LJ			
	2.0 TDI	103	04.08	PR: 1LJ			
	2.0 TFSI	147	04.08	PR: 1LJ			
	1.2 TSI	77	03.10	PR: 1KD	BA2017		20961 17,2/S LUC
	1.4 TFSI	92	01.11	PR: 1KD			
	1.6	75	09.08	PR: 1KD			
	1.6 TDI	77	05.09	PR: 1KD			
	1.8 TFSI	118	04.08	PR: 1KD			
	1.9 TDI	77	04.08	PR: 1KD			
	2.0 TDI	100	04.08	PR: 1KD			
	2.0 TDI	103	04.08	PR: 1KD			
	2.0 TFSI	147	04.08	PR: 1KD			
	1.2 TSI	77	03.10	PR: 1KZ	BA2196		23914 16,3 /WE/S LUC
	1.4 TFSI	92	01.11	PR: 1KZ			
	1.6	75	09.08	PR: 1KZ			
	1.6 TDI	77	05.09	PR: 1KZ			
	1.8 TFSI	118	04.08	PR: 1KZ			
	1.9 TDI	77	04.08	PR: 1KZ			
	2.0 TDI	100	04.08	PR: 1KZ			
	2.0 TDI	103	04.08	PR: 1KZ			
	2.0 TFSI	147	04.08	PR: 1KZ			
	1.2 TSI	77	03.10	PR: 1KZ	BAR12169		282 12,0 10,0
	1.4 TFSI	92	01.11	PR: 1KZ			
	1.6	75	09.08	PR: 1KZ			
	1.6 TDI	77	05.09	PR: 1KZ			
	1.8 TFSI	118	04.08	PR: 1KZ			
	1.9 TDI	77	04.08	PR: 1KZ			
	2.0 TDI	100	04.08	PR: 1KZ			
	2.0 TDI	103	04.08	PR: 1KZ			
	2.0 TFSI	147	04.08	PR: 1KZ			

**AUDI A4 (B5) (95-01)**

	1.6		8D-V-160000	11.94		BA2031 BA2160	20669 19,6/S 21945 19,6/S	LUC LUC				
	1.9 TDI	55	8D-V-160000	03.96								
	1.9 TDI	66	8D-V-160000	01.95								
	1.8	85	8D-V-054061	07.95	+ (MC) / + GUS-Staaten <sup>1)</sup>	BA2148 BA2172	21624 20,6 + 23018 20,6 +/WK	ATE ATE				
	1.8	92	8D-V-054061	11.94								
	1.8	95	8D-V-054061	01.95								
	1.8 T			05.95	04.01							
	1.9 TDI			02.96	04.01							
	1.9 TDI	81		01.98	04.01							
	2.4			07.95	07.97 + (T)							
	2.4	121		08.97	04.01							
	2.5 TDI			08.97	04.01							
	2.6			11.94	04.01							
	2.8	128		11.94	07.97							
	2.8	142		03.96	04.01							
	1.8 quattro	85	8D-V-054061	11.94					+ GUS-Staaten <sup>2)</sup>	BA2148	21624 20,6 +	ATE
	1.8 quattro	92	8D-V-054061	02.95								
1.8 T quattro	110		02.95	01.99								
1.8 T quattro	132		08.97	01.99								
1.9 TDI quattro	81		07.96	01.99								
1.9 TDI quattro	85		01.98	01.99								
2.4 quattro			08.97	01.99								
2.5 TDI quattro			11.97	01.99								
2.6 quattro			11.94	01.99								
2.8 quattro	128		11.94	07.96								
2.8 quattro	142		06.96	01.99								
	1.8 T quattro	110		02.99	04.01	BA2172	23018 20,6 +/WK	ATE				
	1.8 T quattro	132		02.99	04.01							
	1.9 TDI quattro	81		02.99	04.01							
	1.9 TDI quattro	85		02.99	04.01							

<sup>1)</sup> + (MC) / + GUS States / + (MC) / + Stati del GUS / + (MC) / + Etats de la CEI / + (MC) / + estados del GUS

<sup>2)</sup> + GUS States / + Stati del GUS / + Etats de la CEI / + estados del GUS

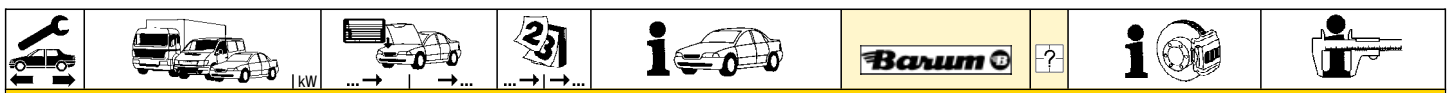

**AUDI A4 (B5) (95-01)**

	2.4 quattro			02.99	04.01	BA2172		23018 20,6 +/WK	ATE
	2.5 TDI quattro			02.99	04.01				
	2.6 quattro			02.99	04.01				
	2.8 quattro	142		02.99	04.01				
	1.6		8D-V-160001		04.01	BA2160		21945 19,6 /S	LUC
	1.8		85 8D-V-054062		04.01	BA2198	+ (V) / + GUS-Staaten 1)	21945 19,6 +/WK/S	LUC
	1.8		92 8D-V-054062		04.01				
	1.8		95 8D-V-054062		04.01				
	1.8 quattro		85 8D-V-054062		04.01		+ GUS-Staaten 2)		
	1.8 quattro		92 8D-V-054062		04.01				
1.9 TDI		55 8D-V-160001		04.01					
1.9 TDI		66 8D-V-160001		04.01					
	1.8		8D-V-054061	07.95	04.01	BAR15105	+ (V) / + GUS-Staaten 1)	288 15,0 13,0 L	
	1.8		92 8D-V-054061	11.94	04.01				
	1.8		95 8D-V-054061	01.95	04.01				
	1.8 quattro		85 8D-V-054061	07.95	04.01		+ GUS-Staaten 2)		
	1.8 quattro		92 8D-V-054061	11.94	04.01				
	1.6		8D-V-160001		04.01	BAR22152		280 22,0 20,0 V L	
	1.8		85 8D-V-054062		04.01		+ (V) / + GUS-Staaten 1)		
	1.8		92 8D-V-054062		04.01				
	1.8		95 8D-V-054062		04.01				
	1.8 quattro		85 8D-V-054062		04.01		+ GUS-Staaten 2)		
	1.8 quattro		92 8D-V-054062		04.01				
	1.9 TDI		55 8D-V-160001		04.01				
	1.9 TDI		66 8D-V-160001		04.01				
	1.8 T			05.95	04.01	BAR25105		288 24,8 23,0 V L	
	1.8 T quattro	110		02.95	04.01				
	1.8 T quattro	132		08.97	04.01				
	1.9 TDI	81		02.96	04.01				
	1.9 TDI	85		01.98	04.01				
	1.9 TDI quattro	81		07.96	04.01				
	1.9 TDI quattro	85		01.98	04.01				
2.4			07.95	07.97		+ (T)			
2.4	121		08.97	04.01					
2.4 quattro			08.97	04.01					
2.5 TDI			08.97	04.01					
2.5 TDI quattro			11.97	04.01					
2.6			11.94	04.01					
2.6 quattro			11.94	04.01					
2.8	128		11.94	07.97					
2.8	142		03.96	04.01					
2.8 quattro	128		11.94	07.96					
2.8 quattro	142		09.96	04.01					
S4 quattro			10.97	04.01	BAR30113		320 30,0 28,0 V L		
	1.6			11.94	04.01	BAH0013	2	L=295	
	1.8			11.94	04.01				
	1.8 quattro	85		11.94	04.01				
	1.8 quattro	92		11.94	04.01				
	1.8 T			05.95	04.01				
	1.8 T quattro	110		02.95	04.01				
	1.8 T quattro	132		08.97	04.01				
	1.9 TDI	55		03.96	04.01				
	1.9 TDI	66		01.95	04.01				
	1.9 TDI	81		02.96	04.01				
	1.9 TDI	85		01.98	04.01				
	1.9 TDI quattro	81		07.96	04.01				
	1.9 TDI quattro	85		01.98	04.01				
	2.4			07.95	04.01		+ (T)		
	2.4	121		08.97	04.01				
	2.4 quattro			08.97	04.01				
	2.5 TDI			08.97	04.01				
	2.5 TDI quattro			11.97	04.01				
	2.6			11.94	04.01				
	2.6 quattro			11.94	04.01				
2.8	128		11.94	07.97					
2.8	142		03.96	04.01					
2.8 quattro	128		11.94	07.96					
2.8 quattro	142		09.96	04.01					
S4 quattro			10.97	04.01					
	1.6		8D-V-160000	11.94	04.01	BA2052		21144 16,6 /S	LUC
	1.8		8D-V-160000	11.94	04.01				
	1.8 quattro	85		11.94	04.01				
	1.8 quattro	92		11.94	04.01				
	1.8 T			05.95	04.01				
	1.8 T quattro	110		02.95	04.01				
	1.8 T quattro	132		08.97	04.01				
	1.9 TDI	55		03.96	04.01				
	1.9 TDI	66		01.95	04.01				
	1.9 TDI	81		02.96	04.01				
	1.9 TDI	85		01.98	04.01				
	1.9 TDI quattro	81		07.96	04.01				
	1.9 TDI quattro	85		01.98	04.01				
	2.4			07.95	04.01		+ (T)		
	2.4 quattro			08.97	04.01				
	2.5 TDI			08.97	04.01				
2.5 TDI quattro			11.97	04.01					

1) + (V) / + GUS States / + (V) / + Stati del GUS / + (V) / + Etats de la CEI / + (V) / + estados del GUS

2) + GUS States / + Stati del GUS / + Etats de la CEI / + estados del GUS

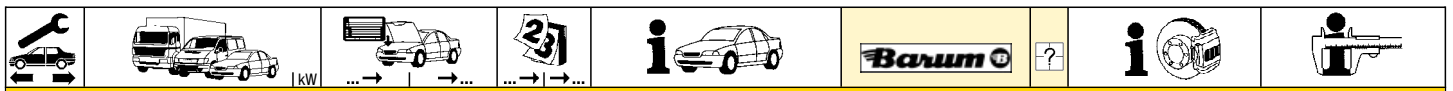



**AUDI A4 (B5) (95-01)**

	2.6 quattro		8D-V-160000	11.94	04.01	BA2052		21144 16,6 /S	LUC				
	2.8	128	8D-V-160000	11.94	04.01								
	2.8	142	8D-V-160000	03.96	04.01								
	2.8 quattro	128		11.94	07.96								
	2.8 quattro	142		09.96	04.01								
	1.6		8D-V-160001		04.01					BA2017 BA2032		20961 17,2 /S	LUC
	1.8		8D-V-160001		04.01								
	1.8 T		8D-V-160001		04.01							20961 15,2 /S	LUC
	1.9 TDI	55	8D-V-160001		04.01								
	1.9 TDI	66	8D-V-160001		04.01								
1.9 TDI	81	8D-V-160001		04.01									
1.9 TDI	85		01.98	04.01									
2.4		8D-V-160001		07.97 + (T)									
2.4	121		08.97	04.01									
2.5 TDI			08.97	04.01									
2.6		8D-V-160001		04.01									
2.8	128	8D-V-160001		07.97									
2.8	142	8D-V-160001		04.01									
S4 quattro			10.97	04.01									
	1.6			11.94	04.01	BAR10210		245 10,0 8,0					
	1.8			11.94	04.01								
	1.8 T			05.95	04.01								
	1.9 TDI	55		03.96	04.01								
	1.9 TDI	66		01.95	04.01								
	1.9 TDI	81		02.96	04.01								
	1.9 TDI	85		01.98	04.01								
	2.4			07.95	07.97 + (T)								
	2.4	121		08.97	04.01								
	2.5 TDI			08.97	04.01								
2.6			11.94	04.01									
2.8	128		11.94	07.97									
2.8	142		03.96	04.01									
	1.8 quattro	85		11.94	04.01	BAR10224		245 10,0 8,0					
	1.8 quattro	92		11.94	04.01								
	1.8 T quattro	110		02.95	04.01								
	1.8 T quattro	132		08.97	04.01								
	1.9 TDI quattro	81		07.96	04.01								
	1.9 TDI quattro	85		01.98	04.01								
	2.4 quattro			08.97	04.01								
	2.5 TDI quattro			11.97	04.01								
	2.6 quattro			11.94	04.01								
	2.8 quattro	128		11.94	07.96								
2.8 quattro	142		06.96	04.01									

**AUDI A4 (B6/B7) (01-08)**

	1.6	75		12.00	11.08	PR: 1LZ	BA2198		21945 19,6 +/WK/S	LUC
	1.8 T	110		12.00	11.08	PR: 1LZ				
	1.8 T	120		07.02	11.08	PR: 1LZ				
	1.8 T	125		07.01	11.08	PR: 1LZ				
	1.8 T	140		11.02	11.08	PR: 1LZ				
	1.8 T Quattro	110		12.00	11.08	PR: 1LZ				
	1.8 T Quattro	120		07.02	11.08	PR: 1LZ				
	1.8 T Quattro	125		07.01	11.08	PR: 1LZ				
	1.8 T Quattro	140		11.02	11.08	PR: 1LZ				
	1.9 TDI	74		04.01	11.08	PR: 1LZ				
	1.9 TDI	85		06.04	11.08	PR: 1LZ				
	1.9 TDI	96		12.00	11.08	PR: 1LZ				
	1.9 TDI Quattro			12.00	11.08	PR: 1LZ				
	2.0	96		12.00	11.08	PR: 1LZ				
	2.0 FSI	110		07.02	11.08	PR: 1LZ				
	2.0 TDI	100		11.04	11.08	PR: 1LZ				
	2.0 TDI	103		11.04	11.08	PR: 1LZ				
	2.0 TDI	125		06.06	11.08	PR: 1LZ				
	2.0 TDI Quattro	103		01.06	11.08	PR: 1LZ				
	2.0 TDI Quattro	125		06.06	11.08	PR: 1LZ				
	2.0 TFSI	147		11.04	11.08	PR: 1LZ				
	2.0 TFSI	162		06.05	11.08	PR: 1LZ				
	2.0 TFSI Quattro	147		11.04	11.08	PR: 1LZ				
	2.0 TFSI Quattro	162		06.05	11.08	PR: 1LZ				
	2.4			09.01	11.08	PR: 1LZ				
	2.5 TDI			12.00	11.08	PR: 1LZ				
	2.5 TDI Quattro			12.00	11.08	PR: 1LZ				
	2.7 TDI	120		11.05	11.08	PR: 1LZ				
	2.7 TDI	132		01.06	11.08	PR: 1LZ				
	3.0			12.00	11.08	PR: 1LZ				
3.0 Quattro			12.00	11.08	PR: 1LZ					
3.0 TDI Quattro	150		11.04	11.08	PR: 1LZ					
3.0 TDI Quattro	171		01.06	11.08	PR: 1LZ					
3.2 FSI	188		01.05	11.08	PR: 1LZ					
3.2 FSI Quattro	188		01.05	11.08	PR: 1LZ					
1.6	75		12.00	11.08	PR: 1LB,1LE,1LF,1LT	BA2172		23018 20,6 +/WK	ATE	
1.8 T	110		12.00	11.08	PR: 1LB,1LE,1LF,1LT					
1.8 T	120		07.02	11.08	PR: 1LB,1LE,1LF,1LT					
1.8 T	125		07.01	11.08	PR: 1LB,1LE,1LF,1LT					
1.8 T	140		11.02	11.08	PR: 1LB,1LE,1LF,1LT					
1.8 T Quattro	110		12.00	11.08	PR: 1LB,1LE,1LF,1LT					

**AUDI A4 (B6/B7) (01-08)**



	1.8 T Quattro 120 1.8 T Quattro 125 1.8 T Quattro 140 1.9 TDI 74 1.9 TDI 85 1.9 TDI 96 1.9 TDI Quattro 2.0 96 2.0 FSI 110 2.0 TDI 100 2.0 TDI 103 2.0 TDI 125 2.0 TDI Quattro 103 2.0 TDI Quattro 125 2.0 TFSI 147 2.0 TFSI 162 2.0 TFSI Quattro 147 2.0 TFSI Quattro 162 2.4 2.5 TDI 120 2.5 TDI Quattro 2.7 TDI 132 2.7 TDI 3.0 3.0 Quattro 3.0 TDI Quattro 150 3.0 TDI Quattro 171 3.2 FSI 188 3.2 FSI Quattro 188		07.02 11.08 PR: 1LB,1LE,1LF,1LT 07.01 11.08 PR: 1LB,1LE,1LF,1LT 11.02 11.08 PR: 1LB,1LE,1LF,1LT 04.01 11.08 PR: 1LB,1LE,1LF,1LT 06.04 11.08 PR: 1LB,1LE,1LF,1LT 12.00 11.08 PR: 1LB,1LE,1LF,1LT 12.00 11.08 PR: 1LB,1LE,1LF,1LT 12.00 11.08 PR: 1LB,1LE,1LF,1LT 07.02 11.08 PR: 1LB,1LE,1LF,1LT 11.04 11.08 PR: 1LB,1LE,1LF,1LT 11.04 11.08 PR: 1LB,1LE,1LF,1LT 06.06 11.08 PR: 1LB,1LE,1LF,1LT 01.06 11.08 PR: 1LB,1LE,1LF,1LT 06.06 11.08 PR: 1LB,1LE,1LF,1LT 11.04 11.08 PR: 1LB,1LE,1LF,1LT 06.05 11.08 PR: 1LB,1LE,1LF,1LT 11.04 11.08 PR: 1LB,1LE,1LF,1LT 06.05 11.08 PR: 1LB,1LE,1LF,1LT 09.01 11.08 PR: 1LB,1LE,1LF,1LT 12.00 11.08 PR: 1LB,1LE,1LF,1LT 12.00 11.08 PR: 1LB,1LE,1LF,1LT 11.05 11.08 PR: 1LB,1LE,1LF,1LT 01.06 11.08 PR: 1LB,1LE,1LF,1LT 12.00 11.08 PR: 1LB,1LE,1LF,1LT 12.00 11.08 PR: 1LB,1LE,1LF,1LT 11.04 11.08 PR: 1LB,1LE,1LF,1LT 01.06 11.08 PR: 1LB,1LE,1LF,1LT 01.05 11.08 PR: 1LB,1LE,1LF,1LT 01.05 11.08 PR: 1LB,1LE,1LF,1LT	BA2172		23018 20,6 +/WK ATE
	1.6 75 1.8 T 110 1.8 T 120 1.8 T 125 1.8 T 140 1.8 T Quattro 110 1.8 T Quattro 120 1.8 T Quattro 125 1.8 T Quattro 140 1.9 TDI 74 1.9 TDI 85 1.9 TDI 96 1.9 TDI Quattro 2.0 96 2.0 FSI 110 2.0 TDI 100 2.0 TDI 103 2.0 TDI 125 2.0 TDI Quattro 103 2.0 TDI Quattro 125 2.0 TFSI 147 2.0 TFSI 162 2.0 TFSI Quattro 147 2.0 TFSI Quattro 162 2.4 2.5 TDI 120 2.5 TDI Quattro 2.7 TDI 132 2.7 TDI 3.0 3.0 Quattro 3.0 TDI Quattro 150 3.0 TDI Quattro 171 3.2 FSI 188 3.2 FSI Quattro 188		12.00 11.08 PR: 1LA,1LC 12.00 11.08 PR: 1LA,1LC 07.02 11.08 PR: 1LA,1LC 07.01 11.08 PR: 1LA,1LC 11.02 11.08 PR: 1LA,1LC 12.00 11.08 PR: 1LA,1LC 07.02 11.08 PR: 1LA,1LC 07.01 11.08 PR: 1LA,1LC 11.02 11.08 PR: 1LA,1LC 04.01 11.08 PR: 1LA,1LC 06.04 11.08 PR: 1LA,1LC 12.00 11.08 PR: 1LA,1LC 12.00 11.08 PR: 1LA,1LC 07.02 11.08 PR: 1LA,1LC 11.04 11.08 PR: 1LA,1LC 06.06 11.08 PR: 1LA,1LC 01.06 11.08 PR: 1LA,1LC 06.06 11.08 PR: 1LA,1LC 11.04 11.08 PR: 1LA,1LC 06.05 11.08 PR: 1LA,1LC 11.04 11.08 PR: 1LA,1LC 06.05 11.08 PR: 1LA,1LC 09.01 11.08 PR: 1LA,1LC 12.00 11.08 PR: 1LA,1LC 12.00 11.08 PR: 1LA,1LC 11.05 11.08 PR: 1LA,1LC 01.06 11.08 PR: 1LA,1LC 12.00 11.08 PR: 1LA,1LC 11.04 11.08 PR: 1LA,1LC 01.06 11.08 PR: 1LA,1LC 01.05 11.08 PR: 1LA,1LC 01.05 11.08 PR: 1LA,1LC	BA2259		23763 19,6 +/WK ATE
	S4 4.2 253		03.03 11.08 PR: 1LJ	BA2259		23763 19,6 +/WK ATE
	1.6 75 1.8 T 110 1.8 T 120 1.8 T 125 1.8 T 140 1.8 T Quattro 110 1.8 T Quattro 120 1.8 T Quattro 125 1.8 T Quattro 140 1.9 TDI 74 1.9 TDI 85 1.9 TDI 96 1.9 TDI Quattro 2.0 96 2.0 FSI 110 2.0 TDI 100 2.0 TDI 103 2.0 TDI 125 2.0 TDI Quattro 103 2.0 TDI Quattro 125 2.0 TFSI 147 2.0 TFSI 162		12.00 11.08 PR: 1LZ 12.00 11.08 PR: 1LZ 07.02 11.08 PR: 1LZ 07.01 11.08 PR: 1LZ 11.02 11.08 PR: 1LZ 12.00 11.08 PR: 1LZ 07.02 11.08 PR: 1LZ 07.01 11.08 PR: 1LZ 11.02 11.08 PR: 1LZ 04.01 11.08 PR: 1LZ 06.04 11.08 PR: 1LZ 12.00 11.08 PR: 1LZ 12.00 11.08 PR: 1LZ 07.02 11.08 PR: 1LZ 11.04 11.08 PR: 1LZ 06.06 11.08 PR: 1LZ 01.06 11.08 PR: 1LZ 06.06 11.08 PR: 1LZ 11.04 11.08 PR: 1LZ 06.05 11.08 PR: 1LZ	BAR22152		280 22,0 20,0 V L



**AUDI A4 (B6/B7) (01-08)**













	2.0 TFSI Quattro 147 2.0 TFSI Quattro 162 2.4 2.5 TDI 2.5 TDI Quattro 2.7 TDI 120 2.7 TDI 132 3.0 3.0 Quattro 3.0 TDI Quattro 150 3.0 TDI Quattro 171 3.2 FSI 188 3.2 FSI Quattro 188		11.04 11.08 PR: 1LZ 06.05 11.08 PR: 1LZ 09.01 11.08 PR: 1LZ 12.00 11.08 PR: 1LZ 12.00 11.08 PR: 1LZ 11.05 11.08 PR: 1LZ 01.06 11.08 PR: 1LZ 12.00 11.08 PR: 1LZ 12.00 11.08 PR: 1LZ 11.04 11.08 PR: 1LZ 01.06 11.08 PR: 1LZ 01.05 11.08 PR: 1LZ 01.05 11.08 PR: 1LZ	BAR22152		280 22,0 20,0 V L
	1.6 75 1.8 T 110 1.8 T 120 1.8 T 125 1.8 T 140 1.8 T Quattro 110 1.8 T Quattro 120 1.8 T Quattro 125 1.8 T Quattro 140 1.9 TDI 74 1.9 TDI 85 1.9 TDI 96 1.9 TDI Quattro 2.0 96 2.0 FSI 110 2.0 TDI 100 2.0 TDI 103 2.0 TDI 125 2.0 TDI Quattro 103 2.0 TDI Quattro 125 2.0 TFSI 147 2.0 TFSI Quattro 147 2.4 2.5 TDI 2.5 TDI Quattro 2.7 TDI 120 2.7 TDI 132		12.00 11.08 PR: 1LB,1LE 12.00 11.08 PR: 1LB,1LE 07.02 11.08 PR: 1LB,1LE 07.01 11.08 PR: 1LB,1LE 11.02 11.08 PR: 1LB,1LE 12.00 11.08 PR: 1LB,1LE 07.02 11.08 PR: 1LB,1LE 07.01 11.08 PR: 1LB,1LE 11.02 11.08 PR: 1LB,1LE 04.01 11.08 PR: 1LB,1LE 06.04 11.08 PR: 1LB,1LE 12.00 11.08 PR: 1LB,1LE 12.00 11.08 PR: 1LB,1LE 07.02 11.08 PR: 1LB,1LE 11.04 11.08 PR: 1LB,1LE 11.04 11.08 PR: 1LB,1LE 06.06 11.08 PR: 1LB,1LE 01.06 11.08 PR: 1LB,1LE 06.06 11.08 PR: 1LB,1LE 11.04 11.08 PR: 1LB,1LE 11.04 11.08 PR: 1LB,1LE 09.01 11.08 PR: 1LB,1LE 12.00 11.08 PR: 1LB,1LE 12.00 11.08 PR: 1LB,1LE 11.05 11.08 PR: 1LB,1LE 01.06 11.08 PR: 1LB,1LE	BAR25105		288 24,8 23,0 V L
	2.0 TFSI 162 2.0 TFSI Quattro 162 3.0 3.0 Quattro 3.0 TDI Quattro 150 3.0 TDI Quattro 171 3.2 FSI 188 3.2 FSI Quattro 188		06.05 11.08 PR: 1LB,1LE 06.05 11.08 PR: 1LB,1LE 12.00 11.08 PR: 1LB,1LE 12.00 11.08 PR: 1LB,1LE 11.04 11.08 PR: 1LB,1LE 01.06 11.08 PR: 1LB,1LE 01.05 11.08 PR: 1LB,1LE 01.05 11.08 PR: 1LB,1LE	BAR25105		288 24,8 23,0 V L
	1.6 75 1.8 T 110 1.8 T 120 1.8 T 125 1.8 T Quattro 110 1.8 T Quattro 120 1.8 T Quattro 125 1.9 TDI 74 1.9 TDI 85 1.9 TDI 96 1.9 TDI Quattro 2.0 96 2.0 FSI 110 2.0 TDI 100 2.0 TDI 103 2.0 TDI 125 2.0 TDI Quattro 103 2.0 TDI Quattro 125 2.4 2.5 TDI 2.5 TDI Quattro 2.7 TDI 120		12.00 11.08 PR: 1LF,1LT 12.00 11.08 PR: 1LF,1LT 07.02 11.08 PR: 1LF,1LT 07.01 11.08 PR: 1LF,1LT 12.00 11.08 PR: 1LF,1LT 07.02 11.08 PR: 1LF,1LT 07.01 11.08 PR: 1LF,1LT 04.01 11.08 PR: 1LF,1LT 06.04 11.08 PR: 1LF,1LT 12.00 11.08 PR: 1LF,1LT 12.00 11.08 PR: 1LF,1LT 07.02 11.08 PR: 1LF,1LT 11.04 11.08 PR: 1LF,1LT 11.04 11.08 PR: 1LF,1LT 06.06 11.08 PR: 1LF,1LT 01.06 11.08 PR: 1LF,1LT 06.06 11.08 PR: 1LF,1LT 09.01 11.08 PR: 1LF,1LT 12.00 11.08 PR: 1LF,1LT 12.00 11.08 PR: 1LF,1LT 11.05 11.08 PR: 1LF,1LT	BAR25137		312 25,0 23,0 V L
	1.8 T 140 1.8 T Quattro 140 2.0 TFSI 147 2.0 TFSI 162 2.0 TFSI Quattro 147 2.0 TFSI Quattro 162 2.7 TDI 132 3.0 3.0 Quattro 3.0 TDI Quattro 150 3.0 TDI Quattro 171 3.2 FSI 188 3.2 FSI Quattro 188		11.02 11.08 PR: 1LF,1LT 11.02 11.08 PR: 1LF,1LT 11.04 11.08 PR: 1LF,1LT 06.05 11.08 PR: 1LF,1LT 11.04 11.08 PR: 1LF,1LT 06.05 11.08 PR: 1LF,1LT 01.06 11.08 PR: 1LF,1LT 01.06 11.08 PR: 1LF,1LT 12.00 11.08 PR: 1LF,1LT 12.00 11.08 PR: 1LF,1LT 11.04 11.08 PR: 1LF,1LT 01.06 11.08 PR: 1LF,1LT 01.05 11.08 PR: 1LF,1LT 01.05 11.08 PR: 1LF,1LT	BAR25137		312 25,0 23,0 V L
	1.6 75 1.8 T 110 1.8 T 120 1.8 T 125		12.00 11.08 PR: 1LA 12.00 11.08 PR: 1LA 07.02 11.08 PR: 1LA 07.01 11.08 PR: 1LA	BAR30113		320 30,0 28,0 V L

**AUDI A4 (B6/B7) (01-08)**

	1.8 T	140		11.02	11.08	PR: 1LA	BAR30113		320 30,0 28,0 VL	
	1.8 T Quattro	110		12.00	11.08	PR: 1LA				
	1.8 T Quattro	120		07.02	11.08	PR: 1LA				
	1.8 T Quattro	125		07.01	11.08	PR: 1LA				
	1.8 T Quattro	140		11.02	11.08	PR: 1LA				
	1.9 TDI	74		04.01	11.08	PR: 1LA				
	1.9 TDI	85		06.04	11.08	PR: 1LA				
	1.9 TDI	96		12.00	11.08	PR: 1LA				
	1.9 TDI Quattro			12.00	11.08	PR: 1LA				
	2.0	96		12.00	11.08	PR: 1LA				
	2.0 FSI	110		07.02	11.08	PR: 1LA				
	2.0 TDI	100		11.04	11.08	PR: 1LA				
	2.0 TDI	103		11.04	11.08	PR: 1LA				
	2.0 TDI	125		06.06	11.08	PR: 1LA				
	2.0 TDI Quattro	103		01.06	11.08	PR: 1LA				
	2.0 TDI Quattro	125		06.06	11.08	PR: 1LA				
	2.0 TFSI	147		11.04	11.08	PR: 1LA				
	2.0 TFSI	162		06.05	11.08	PR: 1LA				
	2.0 TFSI Quattro	147		11.04	11.08	PR: 1LA				
	2.0 TFSI Quattro	162		06.05	11.08	PR: 1LA				
	2.4			09.01	11.08	PR: 1LA				
	2.5 TDI			12.00	11.08	PR: 1LA				
	2.5 TDI Quattro			12.00	11.08	PR: 1LA				
	2.7 TDI	120		11.05	11.08	PR: 1LA				
	2.7 TDI	132		01.06	11.08	PR: 1LA				
	3.0			12.00	11.08	PR: 1LA				
	3.0 Quattro			12.00	11.08	PR: 1LA				
	3.0 TDI Quattro	150		11.04	11.08	PR: 1LA				
	3.0 TDI Quattro	171		01.06	11.08	PR: 1LA				
	3.2 FSI	188		01.05	11.08	PR: 1LA				
	3.2 FSI Quattro	188		01.05	11.08	PR: 1LA				
	1.6	75		12.00	11.08		BAH0021	2	L=305	
	1.8 T	110		12.00	11.08					
	1.8 T	120		07.02	11.08					
	1.8 T	125		07.01	11.08					
	1.8 T	140		11.02	11.08					
	1.8 T Quattro	110		12.00	11.08					
	1.8 T Quattro	120		07.02	11.08					
	1.8 T Quattro	125		07.01	11.08					
	1.8 T Quattro	140		11.02	11.08					
	1.9 TDI	74		04.01	11.08					
	1.9 TDI	85		06.04	11.08					
	1.9 TDI	96		12.00	11.08					
	1.9 TDI Quattro			12.00	11.08					
	2.0	96		12.00	11.08					
	2.0 FSI	110		07.02	11.08					
	2.0 TDI	100		11.04	11.08					
	2.0 TDI	103		11.04	11.08					
	2.0 TDI	125		06.06	11.08					
	2.0 TDI Quattro	103		01.06	11.08					
	2.0 TDI Quattro	125		06.06	11.08					
	2.0 TFSI	147		11.04	11.08					
	2.0 TFSI	162		06.05	11.08					
	2.0 TFSI Quattro	147		11.04	11.08					
	2.0 TFSI Quattro	162		06.05	11.08					
	2.4			09.01	11.08					
	2.5 TDI			12.00	11.08					
	2.5 TDI Quattro			12.00	11.08					
	2.7 TDI	120		11.05	11.08					
	2.7 TDI	132		01.06	11.08					
	3.0			12.00	11.08					
	3.0 Quattro			12.00	11.08					
	3.0 TDI Quattro	150		11.04	11.08					
	3.0 TDI Quattro	171		01.06	11.08					
	3.2 FSI	188		01.05	11.08					
	3.2 FSI Quattro	188		01.05	11.08					
	S4 4.2	253		03.03	11.08					
	1.6	75	8E-4-180000	12.00		PR: 1KD	BA2017 BA2032		20961 17,2 /S 20961 15,2 /S	LUC LUC
	1.8 T	110	8E-4-180000	12.00		PR: 1KD				
	1.8 T	120	8E-4-180000	07.02		PR: 1KD				
	1.8 T	125	8E-4-180000	07.01		PR: 1KD				
	1.8 T	140	8E-4-180000	11.02		PR: 1KD				
	1.8 T Quattro	110	8E-4-180000	12.00		PR: 1KD				
	1.8 T Quattro	120	8E-4-180000	07.02		PR: 1KD				
	1.8 T Quattro	125	8E-4-180000	07.01		PR: 1KD				
	1.8 T Quattro	140	8E-4-180000	11.02		PR: 1KD				
	1.9 TDI	74	8E-4-180000	04.01		PR: 1KD				
	1.9 TDI	96	8E-4-180000	12.00		PR: 1KD				
	1.9 TDI Quattro		8E-4-180000	12.00		PR: 1KD				
	2.0	96	8E-4-180000	12.00		PR: 1KD				
	2.0 FSI	110	8E-4-180000	07.02		PR: 1KD				
	2.4		8E-4-180000	09.01		PR: 1KD				
	2.5 TDI		8E-4-180000	12.00		PR: 1KD				
	2.5 TDI Quattro		8E-4-180000	12.00		PR: 1KD				
	3.0		8E-4-180000	12.00		PR: 1KD				
	3.0 Quattro		8E-4-180000	12.00		PR: 1KD				
↓	1.6	75	8E-4-180001			11.08 PR: 1KD,1KP	BA2032		20961 15,2 /S	LUC

**AUDI A4 (B6/B7) (01-08)**

	1.8 T	110	8E-4-180001		11.08	PR: 1KD,1KP	BA2032	20961 15,2 /S	LUC
	1.8 T	120	8E-4-180001		11.08	PR: 1KD,1KP			
	1.8 T	125	8E-4-180001		11.08	PR: 1KD,1KP			
	1.8 T	140	8E-4-180001		11.08	PR: 1KD,1KP			
	1.8 T Quattro	110	8E-4-180001		11.08	PR: 1KD,1KP			
	1.8 T Quattro	120	8E-4-180001		11.08	PR: 1KD,1KP			
	1.8 T Quattro	125	8E-4-180001		11.08	PR: 1KD,1KP			
	1.8 T Quattro	140	8E-4-180001		11.08	PR: 1KD,1KP			
	1.9 TDI	74	8E-4-180001		11.08	PR: 1KD,1KP			
	1.9 TDI	85		06.04	11.08	PR: 1KD,1KP			
	1.9 TDI	96	8E-4-180001		11.08	PR: 1KD,1KP			
	1.9 TDI Quattro		8E-4-180001		11.08	PR: 1KD,1KP			
	2.0	96	8E-4-180001		11.08	PR: 1KD,1KP			
	2.0 FSI	110	8E-4-180001		11.08	PR: 1KD,1KP			
	2.0 TDI	103		11.04	11.08	PR: 1KD,1KP			
	2.0 TDI	125		06.06	11.08	PR: 1KD,1KP			
	2.0 TDI Quattro	103		01.06	11.08	PR: 1KD,1KP			
	2.0 TDI Quattro	125		06.06	11.08	PR: 1KD,1KP			
	2.4		8E-4-180001		11.08	PR: 1KD,1KP			
	2.5 TDI		8E-4-180001		11.08	PR: 1KD,1KP			
2.5 TDI Quattro		8E-4-180001		11.08	PR: 1KD,1KP				
3.0		8E-4-180001		11.08	PR: 1KD,1KP				
3.0 Quattro		8E-4-180001		11.08	PR: 1KD,1KP				
	1.6	75	8E-5-400001		11.08	PR: 1KW	BA2196	23914 16,3 /WE/S	LUC
	1.8 T	110	8E-5-400001		11.08	PR: 1KW			
	1.8 T	120	8E-5-400001		11.08	PR: 1KW			
	1.8 T	125	8E-5-400001		11.08	PR: 1KW			
	1.8 T	140	8E-5-400001		11.08	PR: 1KW			
	1.8 T Quattro	110	8E-5-400001		11.08	PR: 1KW			
	1.8 T Quattro	120	8E-5-400001		11.08	PR: 1KW			
	1.8 T Quattro	125	8E-5-400001		11.08	PR: 1KW			
	1.8 T Quattro	140	8E-5-400001		11.08	PR: 1KW			
	1.9 TDI	74	8E-5-400001		11.08	PR: 1KW			
	1.9 TDI	85	8E-5-400001		11.08	PR: 1KW			
	1.9 TDI	96	8E-5-400001		11.08	PR: 1KW			
	1.9 TDI Quattro		8E-5-400001		11.08	PR: 1KW			
	2.0	96	8E-5-400001		11.08	PR: 1KW			
	2.0 FSI	110	8E-5-400001		11.08	PR: 1KW			
	2.0 TDI	100	8E-5-400001		11.08	PR: 1KW			
	2.0 TDI	103	8E-5-400001		11.08	PR: 1KW			
	2.0 TDI	125		06.06	11.08	PR: 1KW			
	2.0 TDI Quattro	103		01.06	11.08	PR: 1KW			
	2.0 TDI Quattro	125		06.06	11.08	PR: 1KW			
2.0 TFSI	147	8E-5-400001		11.08	PR: 1KW				
2.0 TFSI	162	8E-5-400001		11.08	PR: 1KW				
2.0 TFSI Quattro	147	8E-5-400001		11.08	PR: 1KW				
2.0 TFSI Quattro	162	8E-5-400001		11.08	PR: 1KW				
2.4		8E-5-400001		11.08	PR: 1KW				
2.5 TDI		8E-5-400001		11.08	PR: 1KW				
2.5 TDI Quattro		8E-5-400001		11.08	PR: 1KW				
2.7 TDI	120		11.05	11.08	PR: 1KW				
2.7 TDI	132		01.06	11.08	PR: 1KW				
3.0		8E-5-400001		11.08	PR: 1KW				
3.0 Quattro		8E-5-400001		11.08	PR: 1KW				
3.0 TDI Quattro	150	8E-5-400001		11.08	PR: 1KW				
3.0 TDI Quattro	171		01.06	11.08	PR: 1KW				
3.2 FSI	188	8E-5-400001		11.08	PR: 1KW				
3.2 FSI Quattro	188	8E-5-400001		11.08	PR: 1KW				
	1.6	75		12.00	11.08	PR: 1KD	BAR10261	245 10,0 8,0	
	1.8 T	110		12.00	11.08	PR: 1KD			
	1.8 T	120		07.02	11.08	PR: 1KD			
	1.8 T	125		07.01	11.08	PR: 1KD			
	1.8 T	140		11.02	11.08	PR: 1KD			
	1.8 T Quattro	110		12.00	11.08	PR: 1KD			
	1.8 T Quattro	120		07.02	11.08	PR: 1KD			
	1.8 T Quattro	125		07.01	11.08	PR: 1KD			
	1.8 T Quattro	140		11.02	11.08	PR: 1KD			
	1.9 TDI	74		04.01	11.08	PR: 1KD			
	1.9 TDI	85		06.04	11.08	PR: 1KD			
	1.9 TDI	96		12.00	11.08	PR: 1KD			
	1.9 TDI Quattro			12.00	11.08	PR: 1KD			
	2.0	96		12.00	11.08	PR: 1KD			
	2.0 FSI	110		07.02	11.08	PR: 1KD			
	2.0 TDI	100		11.04	11.08	PR: 1KD			
	2.0 TDI	103		11.04	11.08	PR: 1KD			
	2.0 TDI	125		06.06	11.08	PR: 1KD			
	2.0 TDI Quattro	103		01.06	11.08	PR: 1KD			
	2.0 TDI Quattro	125		06.06	11.08	PR: 1KD			
2.0 TFSI	147		11.04	11.08	PR: 1KD				
2.0 TFSI	162		06.05	11.08	PR: 1KD				
2.0 TFSI Quattro	147		11.04	11.08	PR: 1KD				
2.0 TFSI Quattro	162		06.05	11.08	PR: 1KD				
2.4			09.01	11.08	PR: 1KD				
2.5 TDI			12.00	11.08	PR: 1KD				
2.5 TDI Quattro			12.00	11.08	PR: 1KD				
3.0			12.00	11.08	PR: 1KD				
3.0 Quattro			12.00	11.08	PR: 1KD				

								
<b>AUDI A4 (B6/B7) (01-08)</b>								
	3.0 TDI Quattro 3.2 FSI 3.2 FSI Quattro	150 188 188	11.04 01.05 01.05	11.08 11.08 11.08	PR: 1KD PR: 1KD PR: 1KD	BAR10261		245 10,0 8,0
<b>AUDI A4 Cabrio (02-08)</b>								
	1.8 T 1.8 T Quattro 2.0 2.0 TDI 2.0 TFSI 2.0 TFSI 2.0 TFSI quattro 2.4 2.4 2.5 TDI 2.7 TDI 3.0 3.0 Quattro 3.0 TDI Quattro 3.0 TDI Quattro 3.2 FSI 3.2 FSI Quattro	120 120 96 120 147 147 120 125 120 132 162 162 150 171 188 188	04.02 05.03 05.04 10.05 10.05 01.06 11.05 04.02 04.02 08.02 06.06 04.02 05.03 01.06 10.05 10.05	11.08 11.08 11.08 11.08 11.08 11.08 11.08 11.08 11.08 11.08 11.08 11.08 11.08 11.08 11.08 11.08	PR: 1LB,1LE,1LF,1LT PR: 1LB,1LE,1LF,1LT PR: 1LB,1LE,1LF,1LT PR: 1LB,1LE,1LF,1LT PR: 1LB,1LE,1LF,1LT PR: 1LB,1LE,1LF,1LT PR: 1LB,1LE,1LF,1LT PR: 1LB,1LE,1LF,1LT PR: 1LB,1LE,1LF,1LT PR: 1LB,1LE,1LF,1LT PR: 1LB,1LE,1LF,1LT PR: 1LB,1LE,1LF,1LT PR: 1LB,1LE,1LF,1LT PR: 1LB,1LE,1LF,1LT PR: 1LB,1LE,1LF,1LT PR: 1LB,1LE,1LF,1LT	BA2172		23018 20,6 +/WK ATE
	1.8 T 1.8 T Quattro 2.0 2.0 TDI 2.0 TFSI 2.0 TFSI 2.0 TFSI quattro 2.4 2.4 2.5 TDI 2.7 TDI 3.0 3.0 Quattro 3.0 TDI Quattro 3.0 TDI Quattro 3.2 FSI 3.2 FSI Quattro	120 120 96 120 147 147 120 125 120 132 162 162 150 171 188 188	04.02 05.03 05.04 10.05 10.05 01.06 11.05 04.02 04.02 08.02 06.06 04.02 05.03 01.06 10.05 10.05	11.08 11.08 11.08 11.08 11.08 11.08 11.08 11.08 11.08 11.08 11.08 11.08 11.08 11.08 11.08	PR: 1LA PR: 1LA PR: 1LA PR: 1LA PR: 1LA PR: 1LA PR: 1LA PR: 1LA PR: 1LA PR: 1LA PR: 1LA PR: 1LA PR: 1LA PR: 1LA PR: 1LA	BA2259		23763 19,6 +/WK ATE
	S4 4.2 Quattro	253	02.04	11.08		BA2259		23763 19,6 +/WK ATE
	1.8 T 1.8 T Quattro 2.0 2.0 TDI 2.0 TFSI 2.4 2.4 2.5 TDI	120 120 96 120 147 120 125 120	04.02 05.03 05.04 10.05 10.05 04.02 04.02 08.02	11.08 11.08 11.08 11.08 11.08 11.08 11.08	PR: 1LB,1LE PR: 1LB,1LE PR: 1LB,1LE PR: 1LB,1LE PR: 1LB,1LE PR: 1LB,1LE PR: 1LB,1LE	BAR25105		288 24,8 23,0 V L
	2.0 TFSI 2.0 TFSI quattro 2.7 TDI 3.0 3.0 Quattro 3.0 TDI Quattro 3.0 TDI Quattro 3.2 FSI 3.2 FSI Quattro	147 147 132 162 162 150 171 188 188	01.06 11.05 06.06 04.02 05.03 01.06 10.05 10.05	11.08 11.08 11.08 11.08 11.08 11.08 11.08	PR: 1LB,1LE PR: 1LB,1LE PR: 1LB,1LE PR: 1LB,1LE PR: 1LB,1LE PR: 1LB,1LE PR: 1LB,1LE PR: 1LB,1LE	BAR25105		288 24,8 23,0 V L
	1.8 T 1.8 T Quattro 2.0 2.0 TDI 2.0 TFSI 2.4 2.4 2.5 TDI	120 120 96 120 147 120 125 120	04.02 05.03 05.04 10.05 10.05 04.02 04.02 08.02	11.08 11.08 11.08 11.08 11.08 11.08 11.08	PR: 1LF,1LT PR: 1LF,1LT PR: 1LF,1LT PR: 1LF,1LT PR: 1LF,1LT PR: 1LF,1LT PR: 1LF,1LT	BAR25137		312 25,0 23,0 V L
	2.0 TFSI 2.0 TFSI quattro 2.7 TDI 3.0 3.0 Quattro 3.0 TDI Quattro 3.0 TDI Quattro 3.2 FSI 3.2 FSI Quattro	147 147 132 162 162 150 171 188 188	01.06 11.05 06.06 04.02 05.03 01.06 10.05 10.05	11.08 11.08 11.08 11.08 11.08 11.08 11.08	PR: 1LF,1LT PR: 1LF,1LT PR: 1LF,1LT PR: 1LF,1LT PR: 1LF,1LT PR: 1LF,1LT PR: 1LF,1LT PR: 1LF,1LT	BAR25137		312 25,0 23,0 V L
	1.8 T 1.8 T Quattro 2.0 2.0 TDI 2.0 TFSI 2.0 TFSI quattro 2.4 2.4 2.5 TDI	120 120 96 120 147 147 120 125 120	04.02 05.03 05.04 10.05 10.05 01.06 11.05 04.02 04.02 08.02	11.08 11.08 11.08 11.08 11.08 11.08 11.08	PR: 1LA PR: 1LA PR: 1LA PR: 1LA PR: 1LA PR: 1LA PR: 1LA PR: 1LA PR: 1LA	BAR30113		320 30,0 28,0 V L
↓	↓							

### AUDI A4 Cabrio (02-08)

	3.0 Quattro	162		05.03	11.08	PR: 1LA	BAR30113		320 30,0 28,0 VL		
	3.0 TDI Quattro	150		01.06	11.08	PR: 1LA					
	3.0 TDI Quattro	171		10.05	11.08	PR: 1LA					
	3.2 FSI	188		10.05	11.08	PR: 1LA					
	3.2 FSI Quattro	188		10.05	11.08	PR: 1LA					
	1.8 T	120		04.02	11.08		BAH0021	2	L=305		
	1.8 T Quattro	120		05.03	11.08						
	2.0	96		05.04	11.08						
	2.0 TDI			10.05	11.08						
	2.0 TFSI	120		10.05	11.08						
	2.0 TFSI	147		01.06	11.08						
	2.0 TFSI quattro	147		11.05	11.08						
	2.4	120		04.02	11.08						
	2.4	125		04.02	11.08						
	2.5 TDI	120		08.02	11.08						
	2.7 TDI	132		06.06	11.08						
	3.0	162		04.02	11.08						
	3.0 Quattro	162		05.03	11.08						
	3.0 TDI Quattro	150		01.06	11.08						
	3.0 TDI Quattro	171		10.05	11.08						
	3.2 FSI	188		10.05	11.08						
	3.2 FSI Quattro	188		10.05	11.08						
	S4 4.2 Quattro	253		02.04	11.08						
	1.8 T	120		04.02	11.08	PR: 1KD,1KP				BA2032	
	1.8 T Quattro	120		05.03	11.08	PR: 1KD,1KP					
	2.0	96		05.04	11.08	PR: 1KD,1KP					
	2.0 TDI			10.05	11.08	PR: 1KD,1KP					
	2.0 TFSI	120		10.05	11.08	PR: 1KD,1KP					
	2.0 TFSI	147		01.06	11.08	PR: 1KD,1KP					
	2.0 TFSI quattro	147		11.05	11.08	PR: 1KD,1KP					
	2.4	120		04.02	12.05						
	2.4	125		04.02	12.05						
	2.5 TDI	120		08.02	12.05						
	3.0	162		04.02	12.05						
	3.0 Quattro	162		05.03	12.05						
	1.8 T	120	8E-5-400001		11.08	PR: 1KW	BA2196		23914 16,3 /WE/S	LUC	
	1.8 T Quattro	120	8E-5-400001		11.08	PR: 1KW					
	2.0	96	8E-5-400001		11.08	PR: 1KW					
	2.0 TDI		8E-5-400001		11.08	PR: 1KW					
	2.0 TFSI	120	8E-5-400001		11.08	PR: 1KW					
	2.0 TFSI	147	8E-5-400001		11.08	PR: 1KW					
	2.0 TFSI quattro	147	8E-5-400001		11.08	PR: 1KW					
	2.4	120	8E-5-400001		11.08	PR: 1KW					
	2.4	125	8E-5-400001		11.08	PR: 1KW					
	2.5 TDI	120	8E-5-400001		11.08	PR: 1KW					
	2.7 TDI	132	8E-5-400001		11.08	PR: 1KW					
	3.0	162	8E-5-400001		11.08	PR: 1KW					
	3.0 Quattro	162	8E-5-400001		11.08	PR: 1KW					
	3.0 TDI Quattro	150		01.06	11.08	PR: 1KW					
	3.0 TDI Quattro	171	8E-5-400001		11.08	PR: 1KW					
	3.2 FSI	188	8E-5-400001		11.08	PR: 1KW					
	3.2 FSI Quattro	188	8E-5-400001		11.08	PR: 1KW					
	1.8 T	120		04.02	11.08	PR: 1KD	BAR10261		245 10,0 8,0		
	1.8 T Quattro	120		05.03	11.08	PR: 1KD					
	2.0	96		05.04	11.08	PR: 1KD					
	2.0 TDI			10.05	11.08	PR: 1KD					
	2.0 TFSI	120		10.05	11.08	PR: 1KD					
	2.0 TFSI	147		01.06	11.08	PR: 1KD					
	2.0 TFSI quattro	147		11.05	11.08	PR: 1KD					

### AUDI A6 / A6 Avant (4A/C4) (94-97)

	1.8			10.95	12.97		BA2135		20678 19,5 +/-WK	ATE
	1.8 Quattro			10.95	12.97					
	1.9 TDI			06.94	12.97					
	2.0			06.94	12.97					
	2.0 16V			06.94	12.97					
	2.0 Quattro			06.94	12.97					
	2.3			06.94	12.95					
	2.3 Quattro			08.94	12.95					
	2.5 TDI			06.94	12.97					
	2.5 TDI Quattro			07.95	12.97					
	2.6			06.94	12.97					
	2.6 Quattro			06.94	12.97					
	2.8	128		06.94	12.97					
	2.8	142		10.95	12.97					
	2.8 Quattro			06.94	12.97					
	1.8			10.95	12.97		BAR15105		288 15,0 13,0 L	
	1.8 Quattro			10.95	12.97					
	1.9 TDI			06.94	12.97					
	2.0			06.94	12.97					
	2.0 16V			06.94	12.97					
	2.0 Quattro			06.94	12.97					
	2.3			06.94	12.95					
	2.3 Quattro			08.94	12.95					
	2.5 TDI			06.94	12.97					
	2.5 TDI	85		06.94	12.97					
	2.5 TDI	103		10.94	12.97		BAR25105		288 24,8 23,0 VL	
	2.5 TDI Quattro			07.95	12.97					

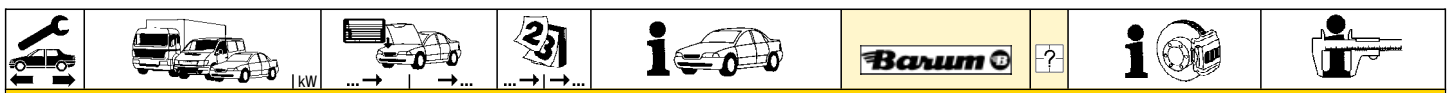

**AUDI A6 / A6 Avant (4A/C4) (94-97)**

	2.6 2.6 Quattro 2.8 2.8 2.8 Quattro		06.94 06.94 06.94 10.95 06.94	12.97 12.97 12.97 12.97 12.97	BAR25105		288 24,8 23,0 VL
	1.8 1.8 Quattro 1.9 TDI 2.0 2.0 16V 2.0 Quattro 2.3 2.3 Quattro 2.5 TDI 2.5 TDI Quattro 2.6 2.6 Quattro 2.8 2.8 2.8 Quattro S6 2.2 S6 4.2 S6 4.2 plus		10.95 10.95 06.94 06.94 06.94 06.94 06.94 08.94 06.94 07.95 06.94 06.94 06.94 10.95 06.94 06.94 09.94 06.96	12.97 12.97 12.97 12.97 12.97 12.97 12.95 12.95 12.97 12.97 12.97 12.97 12.97 12.97 12.97 12.97 12.97 12.97	BAH0026	2	L=270
	1.8 1.8 Quattro 1.9 TDI 2.0 2.0 16V 2.0 Quattro 2.3 2.3 Quattro 2.5 TDI 2.5 TDI Quattro 2.6 2.6 Quattro 2.8 2.8 2.8 Quattro S6 2.2 S6 4.2 S6 4.2 plus		10.95 10.95 06.94 06.94 06.94 06.94 06.94 08.94 06.94 07.95 06.94 06.94 06.94 10.95 06.94 06.94 09.94 06.96	12.97 12.97 12.97 12.97 12.97 12.97 12.95 12.95 12.97 12.97 12.97 12.97 12.97 12.97 12.97 12.97 12.97 12.97	BA2052		21144 16,6 /S LUC
	1.8 1.8 Quattro 1.9 TDI 2.0 2.0 16V 2.0 Quattro 2.3 2.3 Quattro 2.5 TDI 2.5 TDI Quattro 2.6 2.6 Quattro 2.8 2.8 2.8 Quattro		10.95 10.95 06.94 06.94 06.94 06.94 06.94 08.94 06.94 07.95 06.94 06.94 06.94 10.95 06.94 06.94	12.97 12.97 12.97 12.97 12.97 12.97 12.95 12.95 12.97 12.97 12.97 12.97 12.97 12.97 12.97 12.97	BAR10201		245 9,9 8,0
	1.8 1.9 TDI 2.0 2.0 16V 2.3 2.5 TDI 2.6 2.8 2.8 2.8 Quattro		10.95 06.94 06.94 06.94 06.94 06.94 06.94 06.94 10.95 06.94	12.97 12.97 12.97 12.97 12.95 12.97 12.97 12.97 12.97 12.97	BAH0015	2	L=180

**AUDI A6 / A6 Avant (4B/C5) (97-05)**

	1.8 1.8 T 1.8 T 1.8 T Quattro 1.9 TDI 2.0 2.4 2.4 2.4 2.4 Quattro 2.5 TDI 2.5 TDI 2.5 TDI 2.5 TDI Quattro 2.8 2.8 Quattro		04.97 04.97 12.97 04.97 04.97 08.01 07.98 04.97 04.97 04.97 04.97 07.02 02.00 07.97 04.97 04.97	01.05 01.05 01.05 01.05 01.05 01.05 01.05 01.05 01.05 01.05 01.05 01.05 01.05 01.05 01.05 01.05 01.05	BA2172		23018 20,6 +/WK ATE
	1.8 T Quattro 2.4 Quattro 2.5 TDI 2.5 TDI		06.01 06.01 07.02 02.00	01.05 01.05 01.05 01.05	BA2246		23762 19,6 +/WK ATE

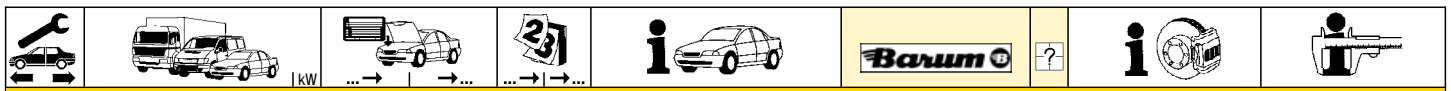

**AUDI A6 / A6 Avant (4B/C5) (97-05)**

	2.5 TDI Quattro 3.0 3.0 Quattro		06.01 06.01 06.01	01.05 01.05 01.05	PR: 1LG,1LA PR: 1LG,1LA PR: 1LG,1LA	BA2246		23762 19,6 +WK	ATE
	1.8 1.8 T 110 1.8 T 132 1.8 T Quattro 1.9 TDI 2.0 2.4 100 2.4 115 2.4 121 2.4 Quattro 2.5 TDI 110 2.5 TDI 120 2.5 TDI 132 2.5 TDI Quattro 2.8 2.8 Quattro		04.97 04.97 12.97 04.97 04.97 08.01 07.98 04.97 04.97 04.97 04.97 07.02 02.00 07.97 04.97 04.97	01.05 01.05 01.05 01.05 01.05 01.05 01.05 01.05 01.05 01.05 01.05 01.05 01.05 01.05 01.05 01.05	PR: 1LB,1LE PR: 1LB,1LE PR: 1LB,1LE PR: 1LB,1LE PR: 1LB,1LE PR: 1LB,1LE PR: 1LB,1LE PR: 1LB,1LE PR: 1LB,1LE PR: 1LB,1LE PR: 1LB,1LE PR: 1LB,1LE PR: 1LB,1LE PR: 1LB,1LE PR: 1LB,1LE	BAR25105		288 24,8 23,0 V L	
	1.8 1.8 T 110 1.8 T 132 1.8 T Quattro 1.9 TDI 2.0 2.4 100 2.4 115 2.4 121 2.4 Quattro 2.5 TDI 110 2.5 TDI 120 2.5 TDI 132 2.5 TDI Quattro 2.8 2.8 Quattro		04.97 04.97 12.97 04.97 04.97 08.01 07.98 04.97 04.97 04.97 04.97 07.02 02.00 07.97 04.97 04.97	01.05 01.05 01.05 01.05 01.05 01.05 01.05 01.05 01.05 01.05 01.05 01.05 01.05 01.05 01.05 01.05	PR: 1LF,1LT PR: 1LF,1LT PR: 1LF,1LT PR: 1LF,1LT PR: 1LF,1LT PR: 1LF,1LT PR: 1LF,1LT PR: 1LF,1LT PR: 1LF,1LT PR: 1LF,1LT PR: 1LF,1LT PR: 1LF,1LT PR: 1LF,1LT PR: 1LF,1LT PR: 1LF,1LT	BAR25137		312 25,0 23,0 V L	
	1.8 T 110 1.8 T Quattro 2.4 Quattro 2.5 TDI 110 2.5 TDI 120 2.5 TDI 132 2.5 TDI Quattro 2.7 T 2.7 T Quattro 3.0 3.0 Quattro		04.97 06.01 06.01 04.97 07.02 02.00 06.01 03.98 10.97 06.01 06.01	01.05 01.05 01.05 01.05 01.05 01.05 01.05 01.05 01.05 01.05 01.05	PR: 1LG,1LA PR: 1LG,1LA PR: 1LG,1LA PR: 1LG,1LA PR: 1LG,1LA PR: 1LG,1LA PR: 1LG,1LA PR: 1LG,1LA PR: 1LG,1LA PR: 1LG,1LA	BAR30113		320 30,0 28,0 V L	
	1.8 1.8 T 110 1.8 T 132 1.8 T Quattro 1.9 TDI 2.0 2.4 100 2.4 115 2.4 121 2.4 Quattro 2.5 TDI 110 2.5 TDI 120 2.5 TDI 132 2.5 TDI Quattro 2.7 T 2.7 T Quattro 2.8 2.8 Quattro 3.0 3.0 Quattro 4.2 Quattro RS6 4.2 S6 4.2		04.97 04.97 12.97 04.97 04.97 08.01 07.98 04.97 04.97 04.97 04.97 07.02 02.00 07.97 03.98 10.97 04.97 04.97 06.01 06.01 11.98 07.02 09.99	01.05 01.05		BAH0013	2	L=295	
	1.8 1.8 T 110 1.8 T 132 1.8 T Quattro 1.9 TDI 2.4 100 2.4 115 2.4 121 2.4 Quattro 2.5 TDI 110 2.5 TDI 132 2.5 TDI Quattro 2.7 T 2.7 T Quattro 2.8 2.8 Quattro 4.2 Quattro S6 4.2		04.97 04.97 12.97 04.97 04.97 07.98 04.97 04.97 04.97 04.97 04.97 02.00 07.97 03.98 10.97 04.97 04.97 11.98 09.99	05.01 05.01 05.01 05.01 05.01 05.01 05.01 05.01 05.01 05.01 05.01 05.01 05.01 05.01 05.01 05.01 05.01 05.01 05.01		BA2017 BA2032		20961 17,2/S 20961 15,2/S	LUC LUC

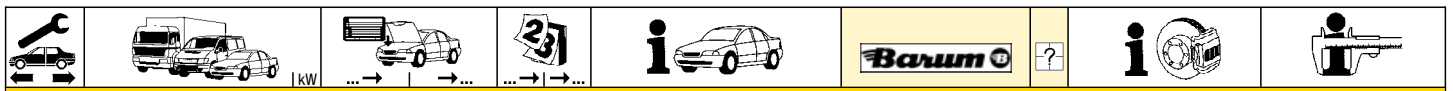













**AUDI A6 / A6 Avant (4B/C5) (97-05)**

	1.8 1.8 T 110 1.8 T 132 1.8 T Quattro 1.9 TDI 2.0 2.4 100 2.4 115 2.4 121 2.4 Quattro 2.5 TDI 110 2.5 TDI 120 2.5 TDI 132 2.5 TDI Quattro 2.7 T 2.7 T Quattro 2.8 2.8 Quattro 3.0 3.0 Quattro 4.2 Quattro S6 4.2			06.01 06.01 06.01 06.01 06.01 08.01 06.01 06.01 06.01 06.01 07.02 06.01 06.01 06.01 06.01 06.01 06.01 06.01 06.01 06.01 06.01 06.01 06.01 06.01	01.05 01.05	BA2032		20961 15,2 /S	LUC
	1.8 1.8 T 110 1.8 T 132 1.9 TDI 2.0 2.4 100 2.4 115 2.4 121 2.5 TDI 110 2.5 TDI 120 2.5 TDI 132 2.7 T 2.8 3.0		04.97 04.97 12.97 04.97 08.01 07.98 04.97 04.97 04.97 07.02 02.00 03.98 04.97 06.01	01.05 01.05 01.05 01.05 01.05 01.05 01.05 01.05 01.05 01.05 01.05 01.05 01.05 01.05 01.05	BAR10201		245 9,9 8,0		
	1.8 T Lim. Quattro 2.4 Lim. Quattro 2.5 TDI Lim. Quattro 2.7 T Lim. Quattro 2.8 Lim. Quattro 3.0 Lim. Quattro		4B-X-200000 04.97 4B-X-200000 04.97 4B-X-200000 07.97 4B-X-200000 10.97 4B-X-200000 04.97 4B-X-200000 06.01			BAR10258		245 10,0 8,0	
	1.8 T Quattro 2.4 Quattro 2.5 TDI Quattro 2.7 T Quattro 2.8 Quattro 3.0 Quattro	4B-Y-000001 4B-Y-000001 4B-Y-000001 4B-Y-000001 4B-Y-000001 4B-Y-000001		01.05 01.05 01.05 01.05 01.05 01.05	PR: ON1 PR: ON1 PR: ON1 PR: ON1 PR: ON1 PR: ON1	BAR10258		245 10,0 8,0	
	1.8 T Quattro 2.4 Quattro 2.5 TDI Quattro 2.7 T Quattro 2.8 Quattro 3.0 Quattro		4B-X-200000 04.97 4B-X-200000 04.97 4B-X-200000 07.97 4B-X-200000 10.97 4B-X-200000 04.97 4B-X-200000 06.01		+ Avant + Avant + Avant + Avant + Avant	BAR10259		255 10,0 8,0	
	1.8 T Quattro 2.4 Quattro 2.5 TDI Quattro 2.7 T Quattro 2.8 Quattro 3.0 Quattro	4B-Y-000001 4B-Y-000001 4B-Y-000001 4B-Y-000001 4B-Y-000001 4B-Y-000001		01.05 01.05 01.05 01.05 01.05 01.05	PR: ON5/ - Avant PR: ON5/ - Avant PR: ON5/ - Avant PR: ON5/ - Avant PR: ON5/ - Avant	BAR10259		255 10,0 8,0	
	1.8 T Quattro 2.4 Quattro 2.5 TDI Quattro 2.7 T Quattro 2.8 Quattro 3.0 Quattro		04.97 04.97 07.97 10.97 04.97 06.01	01.05 01.05 01.05 01.05 01.05 01.05	PR: ON6 PR: ON6 PR: ON6 PR: ON6 PR: ON6	BAR10260		255 10,0 8,0	

**AUDI A6 Allroad (00-05)**



















	2.5 TDI 2.7 T 4.2		05.00 05.00 07.02	07.05 07.05 07.05	PR: 1LA PR: 1LA PR: 1LA	BA2246		23762 19,6 +/WK	ATE
	2.5 TDI 2.7 T 4.2		05.00 05.00 07.02	07.05 07.05 07.05		BA2246		23762 19,6 +/WK	ATE
	2.5 TDI 2.7 T 4.2		05.00 05.00 07.02	07.05 07.05 07.05		BAR30113		320 30,0 28,0 V L	
	2.5 TDI 2.7 T 4.2		05.00 05.00 07.02	07.05 07.05 07.05		BA2032		20961 15,2 /S	LUC
	2.5 TDI 2.7 T		05.00 05.00	07.05 07.05		BAR10260		255 10,0 8,0	



        											
AUDI A6 (4F2/C6) Limousine (04-11)		kW		...		...		...		...	
	2.0 TDI	100	06.05	03.11	PR: 1LT	BA2172			23018	20,6 +/WK	ATE
	2.0 TDI	103	07.04	03.11	PR: 1LT						
	2.0 TDI	103	10.08	03.11	PR: 1LT						
	2.0 TDI	103	10.08	03.11	PR: 1LT						
	2.0 TDI	103	10.08	03.11	PR: 1LT						
	2.0 TDI	125	10.08	03.11	PR: 1LT						
	2.0 TFSI	125	06.05	03.11	PR: 1LT						
	2.4	130	04.04	03.11	PR: 1LT						
	2.4 Quattro	130	01.05	03.11	PR: 1LT						
	2.7 TDI	120	11.04	03.11	PR: 1LT						
	2.7 TDI	132	11.04	03.11	PR: 1LT						
	2.7 TDI Quattro	120	06.05	03.11	PR: 1LT						
	2.7 TDI Quattro	132	11.04	03.11	PR: 1LT						
	2.7 TDI Quattro	140	10.08	03.11	PR: 1LT						
	2.8 FSI	140	10.08	03.11	PR: 1LT						
	2.8 FSI	154	11.06	03.11	PR: 1LT						
	2.8 FSI	162	10.08	03.11	PR: 1LT						
	2.8 FSI Quattro	140	10.08	03.11	PR: 1LT						
	2.8 FSI Quattro	154	04.07	03.11	PR: 1LT						
	2.8 FSI Quattro	162	10.08	03.11	PR: 1LT						
	3.0	160	04.04	03.11	PR: 1LT						
	3.0 Quattro	160	04.04	03.11	PR: 1LT						
	3.0 TDI	171	04.04	03.11	PR: 1LT						
	3.0 TDI Quattro	155	04.04	03.11	PR: 1LT						
3.0 TDI Quattro	165	04.04	03.11	PR: 1LT							
3.0 TDI Quattro	171	06.06	03.11	PR: 1LT							
3.2 FSI	160	04.04	03.11	PR: 1LT							
3.2 FSI Quattro	188	04.04	03.11	PR: 1LT							
4.2 FSI Quattro	257	06.06	03.11	PR: 1LT	BA2172			23018	20,6 +/WK	ATE	
4.2 Quattro	246	04.04	03.11	PR: 1LT							
	2.0 TDI	100	06.05	03.11	PR: 1LG,1LD,1ZL,1LH	BA2259			23763	19,6 +/WK	ATE
	2.0 TDI	103	07.04	03.11	PR: 1LG,1LD,1ZL,1LH						
	2.0 TDI	125	10.08	03.11	PR: 1LG,1ZL						
	2.0 TFSI	125	06.05	03.11	PR: 1LG,1LD,1ZL,1LH						
	2.4	130	04.04	03.11	PR: 1LG,1LD,1ZL,1LH						
	2.4 Quattro	130	01.05	03.11	PR: 1LG,1LD,1ZL,1LH						
	2.7 TDI	120	11.04	03.11	PR: 1LG,1LD,1ZL,1LH						
	2.7 TDI	132	11.04	03.11	PR: 1LG,1LD,1ZL,1LH						
	2.7 TDI	140	10.08	03.11	PR: 1LG,1ZL						
	2.7 TDI Quattro	120	06.05	03.11	PR: 1LG,1LD,1ZL,1LH						
	2.7 TDI Quattro	132	11.04	03.11	PR: 1LG,1LD,1ZL,1LH						
	2.7 TDI Quattro	140	10.08	03.11	PR: 1LG,1ZL						
	2.8 FSI	140	10.08	03.11	PR: 1LG,1ZL						
	2.8 FSI	154	11.06	03.11	PR: 1LG,1LD,1ZL,1LH						
	2.8 FSI	162	10.08	03.11	PR: 1LG,1ZL						
	2.8 FSI Quattro	140	10.08	03.11	PR: 1LG,1ZL						
	2.8 FSI Quattro	154	04.07	03.11	PR: 1LG,1LD,1ZL,1LH						
	2.8 FSI Quattro	162	10.08	03.11	PR: 1LG,1ZL						
	3.0	160	04.04	03.11	PR: 1LG,1LD,1ZL,1LH						
	3.0 Quattro	160	04.04	03.11	PR: 1LG,1LD,1ZL,1LH						
	3.0 TDI	171	06.06	03.11	PR: 1LG,1LD,1ZL,1LH						
	3.0 TDI Quattro	155	04.04	03.11	PR: 1LG,1LD,1ZL,1LH						
	3.0 TDI Quattro	165	04.04	03.11	PR: 1LG,1LD,1ZL,1LH						
	3.0 TDI Quattro	171	04.04	03.11	PR: 1LG,1LD,1ZL,1LH						
3.0 TDI Quattro	176	10.08	03.11	PR: 1LG,1ZL							
3.0 TFSI Quattro	160	10.08	03.11	PR: 1LG,1ZL							
3.2 FSI	160	04.04	03.11	PR: 1LG,1LD,1ZL,1LH							
3.2 FSI Quattro	188	04.04	03.11	PR: 1LG,1LD,1ZL,1LH							
4.2 FSI Quattro	257	06.06	03.11	PR: 1LG,1LD,1ZL,1LH	BA2259			23763	19,6 +/WK	ATE	
4.2 Quattro	246	04.04	03.11	PR: 1LG,1LD,1ZL,1LH							
	2.0 TDI	100	06.05	03.11	PR: 1KD,2ED	BA2196		elektrische Feststellbremse <sup>1)</sup>	23914	16,3 /WE/S	LUC
	2.0 TDI	103	07.04	03.11	PR: 1KD,2ED						
	2.0 TDI	125	10.08	03.11	PR: 1KD						
	2.0 TFSI	125	06.05	03.11	PR: 1KD,2ED						
	2.4	130	04.04	03.11	PR: 1KD,2ED						
	2.4 Quattro	130	01.05	03.11	PR: 1KD,2ED						
	2.7 TDI	120	11.04	03.11	PR: 1KD,2ED						
	2.7 TDI	132	11.04	03.11	PR: 1KD,2ED						
	2.7 TDI	140	10.08	03.11	PR: 1KD						
	2.7 TDI Quattro	120	06.05	03.11	PR: 1KD,2ED						
	2.7 TDI Quattro	132	11.04	03.11	PR: 1KD,2ED						
	2.7 TDI Quattro	140	10.08	03.11	PR: 1KD						
	2.8 FSI	140	10.08	03.11	PR: 1KD						
	2.8 FSI	154	11.06	03.11	PR: 1KD,2ED						
	2.8 FSI	162	10.08	03.11	PR: 1KD						
	2.8 FSI Quattro	140	10.08	03.11	PR: 1KD						
	2.8 FSI Quattro	154	04.07	03.11	PR: 1KD,2ED						
	2.8 FSI Quattro	162	10.08	03.11	PR: 1KD						
	3.0	160	04.04	03.11	PR: 1KD,2ED						
	3.0 Quattro	160	04.04	03.11	PR: 1KD,2ED						
	3.0 TDI Quattro	155	04.04	03.11	PR: 1KD,2ED						
	3.0 TDI Quattro	165	04.04	03.11	PR: 1KD,2ED						
	3.0 TDI Quattro	171	06.06	03.11	PR: 1KD,2ED						
	3.0 TDI Quattro	176	10.08	03.11	PR: 1KD						
3.0 TFSI Quattro	160	10.08	03.11	PR: 1KD							
3.2 FSI	160	04.04	03.11	PR: 1KD,2ED							
3.2 FSI Quattro	188	04.04	03.11	PR: 1KD,2ED							

<sup>1)</sup> electric parking brake / fr.di stazionamento elettrico / frein à main électrique / freno de mano eléctrico



									
<b>AUDI A8 (94-02)</b>									
	2.5 TDI 2.5 TDI Quattro 2.8 2.8 2.8 30V 2.8 30V Quattro 2.8 Quattro 2.8 Quattro 3.7 3.7 Quattro 4.2 Quattro S8 4.2		06.97 06.97 07.95 06.94 04.96 04.96 07.95 06.94 07.95 10.95 06.94 06.96	09.98 09.98 03.96 03.96 09.98 09.98 03.96 03.96 09.98 09.98 09.98 09.98		BA2052		21144 16,6 /S	LUC
	2.5 TDI 2.5 TDI Quattro 2.8 30V 2.8 30V Quattro 3.3 TDI Quattro 3.7 3.7 Quattro 4.2 Quattro 6.0 W12 Quattro S8 4.2	142 142	10.98 10.98 10.98 12.99 10.98 10.98 10.98 01.01 10.98	09.02 09.02 09.02 09.02 09.02 09.02 09.02 09.02 09.02	- Sonderfahrzeuge <sup>1)</sup> - Sonderfahrzeuge <sup>1)</sup> - Sonderfahrzeuge <sup>1)</sup> - Sonderfahrzeuge <sup>1)</sup> - Sonderfahrzeuge <sup>1)</sup> - Sonderfahrzeuge <sup>1)</sup> - Sonderfahrzeuge <sup>1)</sup> - Sonderfahrzeuge <sup>1)</sup> - Sonderfahrzeuge <sup>1)</sup>	BA2017 BA2032		20961 17,2 /S 20961 15,2 /S	LUC LUC
	6.0 W12 Quattro S8 4.2		01.01 10.98	09.02 09.02	- Sonderfahrzeuge <sup>1)</sup>	BAR22152		280 22,0 20,0 V L	
<b>AUDI A8 (03-09)</b>									
	2.8 FSI 3.0 3.0 TDI Quattro 3.2 FSI 3.2 FSI Quattro 3.7 Quattro	154	08.07 07.03 11.03 06.05 06.05 11.02	10.09 PR: 1LG 10.09 PR: 1LG 10.09 PR: 1LG 10.09 PR: 1LG 10.09 PR: 1LG		BA2259		23763 19,6 +/WK	ATE
	4.0 TDI Quattro 4.2 FSI Quattro 4.2 Quattro 4.2 TDI Quattro 6.0 W12 Quattro	257	03.03 06.06 11.02 07.05 02.04	10.09 PR: 1LG 10.09 PR: 1LG 10.09 PR: 1LG 10.09 PR: 1LG		BA2259		23763 19,6 +/WK	ATE
<b>AUDI CABRIO (91-00)</b>									
	1.8 1.9 TDI 2.0 2.0 2.3 2.6	85 103	04.97 07.95 01.93 05.95 07.91 01.94	08.00 08.00 07.98 07.96 + ⊕ 06.94 08.00		BA2031		20669 19,6 /S	LUC
	2.3		8G-N-025000 07.91			BAR22108		256 22,0 20,0 V L	
	1.8 1.9 TDI 2.0 2.0 2.3 2.6	85 103	04.97 07.95 01.93 05.95 07.91 01.94	08.00 08.00 07.98 07.96 + ⊕ 06.94 08.00		BAR22139		280 21,9 20,0 V L	
	1.8 1.9 TDI 2.0 2.0 2.3 2.6 2.8	85 103	04.97 07.95 01.93 05.95 07.91 01.94 11.92	08.00 08.00 07.98 07.96 + ⊕ 06.94 08.00		BAH0012 BAH0003	2 2	am Bremssattel <sup>2)</sup>	L=285 L=160
	1.8 1.9 TDI 2.0 2.0 2.3 2.6 2.8	85 103	04.97 07.95 01.93 05.95 07.91 01.94 11.92	08.00 08.00 07.98 07.96 + ⊕ 06.94 08.00		BA2052		21144 16,6 /S	LUC
	1.8 1.9 TDI 2.0 2.0 2.3 2.6 2.8	85 103	04.97 07.95 01.93 05.95 07.91 01.94 11.92	08.00 08.00 07.98 07.96 + ⊕ 06.94 08.00		BAR10178		245 9,9 8,0	
	1.8 1.9 TDI 2.0 2.0 2.3 2.6 2.8	85 103	04.97 07.95 01.93 05.95 07.91 01.94 11.92	08.00 08.00 07.98 07.96 + ⊕ 06.94 08.00		BAH0003	2	am Bremssattel <sup>2)</sup>	L=160

<sup>1)</sup> - special vehicles / - veicoli speciali / - véhicule spécial / - vehículo especial

<sup>2)</sup> on the brake caliper / sulla pinza freno / sur l'étrier de frein / a la pinza de freno

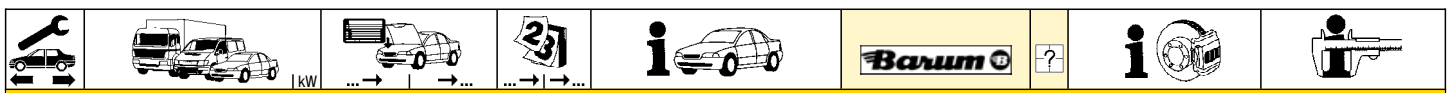



















AUDI COUPE (89-96)										
	2.2			08.88	10.88		BA2178		20669 16,3 / S	LUC
	2.3			08.88	10.88					
	1.8			08.88	07.91		BA2031		20669 19,6 / S	LUC
	2.0			05.89	12.96					
	2.2			11.88	07.91					
	2.3	98		03.90	12.96					
	2.3	100		11.88	07.94					
	2.6			08.92	12.96					
	1.8			08.88	07.91		BAR22108		256 22,0 20,0 V L	
	2.0			05.89	07.92					
	2.2			11.88	07.91					
	2.3	98		03.90	07.92					
	2.3	100		11.88	07.92					
	2.0			08.92	12.96		BAR22139		280 21,9 20,0 V L	
	2.3	98		08.92	12.96					
	2.3	100		08.92	07.94					
	2.6			08.92	12.96					
	1.8			8B-L-003791	08.88		BAH0010	2		L=310
	2.0			8B-L-003791	08.88					
	2.2			8B-L-003791	08.88					
	2.3			8B-L-003791	08.88					
	1.8	8B-L-003792			07.91		BAH0012	2		L=285
	2.0	8B-L-003792			12.96		BAH0003	2	am Bremssattel <sup>1)</sup>	L=160
	2.2	8B-L-003792			07.91					
	2.3	8B-L-003792			07.94					
	2.6				08.92	12.96				
	2.8				09.91	12.96				
	1.8			08.88	07.91		BA2052		21144 16,6 / S	LUC
	2.0			08.88	12.96					
	2.2	100		08.88	07.91					
	2.3			08.88	12.96					
	2.6			08.92	12.96					
	2.8			09.91	12.96					
	1.8			08.88	07.91		BAR10178		245 9,9 8,0	
	2.0			08.88	12.96					
	2.2	100		08.88	07.91					
	2.3			08.88	07.94					
	2.6			08.92	12.96					
	2.8			09.91	12.96					
	1.8			08.88	10.88		BAH0015	2		L=180
	2.0			08.88	10.88					
	2.2	100		08.88	10.88		BAH0003	2		L=160
	2.3	100		08.88	10.88					
	1.8			11.88	07.91		BAH0003	2	am Bremssattel <sup>1)</sup>	L=160
	2.0			11.88	12.96					
	2.2			11.88	07.91					
	2.3			11.88	07.94					
	2.6			08.92	12.96					
	2.8			09.91	12.96					
	1.8			08.88	10.88		BAW1501		+ GG <sup>2)</sup>	Rz 15,87

AUDI COUPE Quattro (87-96)										
	2.2	100		01.88	07.91		BA2031		20669 19,6 / S	LUC
	2.3	98		05.90	12.96					
	2.3	100		01.88	07.94					
	2.6			08.92	12.96					
	2.2	100		8B-N-015000	01.88		BAR22108		256 22,0 20,0 V L	
	2.3	98		8B-N-015000	05.90					
	2.3	100		8B-N-015000	01.88					
	2.3	98 8B-P-000001			12.96		BAR22139		280 21,9 20,0 V L	
	2.3	100 8B-P-000001			07.94					
	2.6				08.92	12.96 + 15" Rad <sup>3)</sup>				
	2.0			8B-L-003000	11.88		BAH0010	2		L=310
	2.2	100		8B-L-003000	01.88					
	2.3	98		8B-L-003000	05.90					
	2.3	100		8B-L-003000	01.88					
	2.0	8B-L-003001			07.91 + F I		BAH0012	2		L=285
	2.2	100 8B-L-003001			07.91		BAH0003	2	am Bremssattel <sup>1)</sup>	L=160
	2.3	98 8B-L-003001			12.96					
	2.3	100 8B-L-003001			07.94					
	2.3 20V	123 8B-L-003001			12.96					
	2.3 20V	125 8B-L-003001			07.91					
	2.6				08.92	12.96				
	2.8				08.91	12.96				
	S2 2.2	162			09.90	09.92				
	S2 2.2	169			10.92	12.96				
	2.0			11.88	07.91 + F I		BA2052		21144 16,6 / S	LUC
	2.2	100		01.88	07.91					
	2.3	98		05.90	12.96					
	2.3	100		01.87	07.94					
	2.3 20V	123		05.90	12.96					
	2.3 20V	125		11.88	07.91					
	2.6			08.92	12.96					

<sup>1)</sup> on the brake caliper / sulla pinza freno / sur l'étrier de frein / a la pinza de freno



















<sup>2)</sup> + cast iron / + ghisa / + fonte grise / + fundición de gris

















<sup>3)</sup> + 15" wheel / + ruota 15" / + roue 15" / + rueda 15"

								
<b>AUDI COUPE Quattro (87-96)</b>								
	2.8 S2 2.2 S2 2.2	162 169	08.91 09.90 10.92	12.96 09.92 12.96		BA2052		21144 16,6 / S LUC
	2.6 2.8 S2 2.2	169	08.92 08.91 10.92	12.96 + 16" Rad <sup>1)</sup> 12.96 + 16" Rad <sup>1)</sup> 12.96 + 16" Rad <sup>1)</sup>		BAR10261		245 10,0 8,0
<b>AUDI Q3 (11-)</b>								
	2.0 TDI 2.0 TDI quattro 2.0 TDI quattro 2.0 TFSI quattro 2.0 TFSI quattro	103 103 130 125 155	06.11 01.12 06.11 06.11 06.11	PR: 1LJ PR: 1LJ PR: 1LJ PR: 1LJ PR: 1LJ		BAR25158		312 25,0 22,0 V L
	2.0 TDI 2.0 TDI quattro 2.0 TDI quattro 2.0 TFSI quattro 2.0 TFSI quattro	103 103 130 125 155	06.11 01.12 06.11 06.11 06.11	PR: 1KU PR: 1KU PR: 1KU PR: 1KU PR: 1KU		BAR12169	elektrische Feststellbremse <sup>2)</sup>	282 12,0 10,0
<b>AUDI Q7 (06-)</b>								
	3.0 TDI 3.0 TDI 3.0 TDI 3.0 TDI 3.0 TDI 3.0 TDI 3.0 TDI 3.0 TFSI 3.6 FSI	150 155 165 171 176 180 180 206	05.10 03.06 06.09 03.06 11.07 05.11 05.10 08.06	PR: 1LF PR: 1LF PR: 1LF PR: 1LF PR: 1LF PR: 1LF PR: 1LF		BAV1052	2	Warnkontakt L=420mm
	4.2 FSI 4.2 TDI 6.0 TDI	257 240 368	03.06 03.07 09.08	PR: 1LF PR: 1LF PR: 1LF		BAV1052	2	Warnkontakt L=420mm
	3.0 TDI 3.0 TDI 3.0 TDI 3.0 TDI 3.0 TDI 3.0 TDI 3.0 TDI 3.0 TFSI 3.6 FSI 4.2 FSI 4.2 TDI 6.0 TDI	150 155 165 171 176 180 180 206 206 257 240 368	05.10 03.06 06.09 03.06 11.07 05.11 05.10 08.06 03.06 03.07 09.08	PR: 1KF,2EA PR: 1KF,2EA PR: 1KF,2EA PR: 1KF,2EA PR: 1KF,2EA PR: 1KF,2EA PR: 1KF,2EA PR: 1KF,2EA PR: 1KF,2EA PR: 1KF,2EA PR: 1KF,2EA		BAV1053	2	Warnkontakt L=255mm
<b>AUDI TT Coupe (98-06)</b>								
	1.8 T 1.8 T 1.8 T 1.8 T 1.8 T 1.8 T 1.8 T 1.8 T 1.8 T 1.8 T 1.8 T 1.8 T	110 120 132 140 132 140 165 176	09.02 09.05 10.98 09.05 10.98 09.05 10.98 03.05	06.06 PR: 1LD,1LT,1LV 06.06 PR: 1LD,1LT,1LV 06.06 PR: 1LD,1LT,1LV 06.06 PR: 1LD,1LT,1LV 06.06 PR: 1LD,1LT,1LV 06.06 PR: 1LD,1LT,1LV 06.06 PR: 1LD,1LT,1LV 06.06 PR: 1LD,1LT,1LV		BA2333 BA2205		21911 20,3 + 23392 20,6 +/WK ATE ATE
	1.8 T 1.8 T 1.8 T 1.8 T 1.8 T 1.8 T 1.8 T 1.8 T 1.8 T 1.8 T	110 120 132 140 132 140 165 176	09.02 09.05 10.98 09.05 10.98 09.05 10.98 03.05	06.06 PR: 1LD,1LT,1LV 06.06 PR: 1LD,1LT,1LV 06.06 PR: 1LD,1LT,1LV 06.06 PR: 1LD,1LT,1LV 06.06 PR: 1LD,1LT,1LV 06.06 PR: 1LD,1LT,1LV 06.06 PR: 1LD,1LT,1LV 06.06 PR: 1LD,1LT,1LV		BAR25123		312 25,0 23,0 V L
	1.8 T 1.8 T 1.8 T 1.8 T 1.8 T 1.8 T 1.8 T 1.8 T 1.8 T 1.8 T 3.2 Quattro	110 120 132 140 132 140 165 176 184	8N5-011 000 09.02 8N5-011 000 09.05 8N5-011 000 10.98 8N5-011 000 09.05 8N5-011 000 10.98 8N5-011 000 09.05 8N5-011 000 10.98 8N5-011 000 03.05 8N5-011 000 04.03	PR: 1KE,1KF,1KK,2EH PR: 1KE,1KF,1KK,2EH PR: 1KE,1KF,1KK,2EH PR: 1KE,1KF,1KK,2EH PR: 1KE,1KF,1KK,2EH PR: 1KE,1KF,1KK,2EH PR: 1KE,1KF,1KK,2EH PR: 1KE,1KF,1KK,2EH PR: 1KE,1KF,1KK,2EH		BA2017 BA2032		20961 17,2 / S LUC 20961 15,2 / S LUC
	1.8 T 1.8 T 1.8 T 1.8 T 1.8 T 1.8 T 1.8 T 1.8 T 1.8 T 1.8 T 3.2 Quattro	110 120 132 140 132 140 165 176 184	8N5-011 001 8N5-011 001 8N5-011 001 8N5-011 001 8N5-011 001 8N5-011 001 8N5-011 001 8N5-011 001 8N5-011 001 8N5-011 001	06.06 PR: 1KE,1KF,1KK,2EH 06.06 PR: 1KE,1KF,1KK,2EH 06.06 PR: 1KE,1KF,1KK,2EH 06.06 PR: 1KE,1KF,1KK,2EH 06.06 PR: 1KE,1KF,1KK,2EH 06.06 PR: 1KE,1KF,1KK,2EH 06.06 PR: 1KE,1KF,1KK,2EH 06.06 PR: 1KE,1KF,1KK,2EH 06.06 PR: 1KE,1KF,1KK,2EH		BA2032		20961 15,2 / S LUC
	1.8 T 1.8 T 1.8 T 1.8 T	110 120 132 140	09.02 09.05 10.98 09.05	PR: 2EK PR: 2EK PR: 2EK PR: 2EK		BA2017		20961 17,2 / S LUC

<sup>1)</sup> + 16" wheel / + ruota 16" / + roue 16" / + rueda 16"

















<sup>2)</sup> electric parking brake / fr.di stazionamento elettrico / frein à main électrique / freno de mano eléctrico

									
<b>AUDI TT Coupe (98-06)</b>									
	1.8 T Quattro	132		10.98	06.06	PR: 1KE	BAR09133		239 8,9 7,0
	1.8 T Quattro	140		09.05	06.06	PR: 1KE			
	1.8 T Quattro	165		10.98	06.06	PR: 1KE			
	1.8 T Quattro	176		03.05	06.06	PR: 1KE			
	3.2 Quattro	184		04.03	06.06	PR: 1KE			
	1.8 T Quattro	132		10.98	06.06	PR: 1KF,2EH	BAR22163		256 22,0 20,0 V L
	1.8 T Quattro	140		09.05	06.06	PR: 1KF,2EH			
	1.8 T Quattro	165		10.98	06.06	PR: 1KF,2EH			
	1.8 T Quattro	176		03.05	06.06	PR: 1KF,2EH			
	3.2 Quattro	184		04.03	06.06	PR: 1KF,2EH			
	1.8 T	110		09.02	06.06		BAH0033	2	L=140
	1.8 T	120		09.05	06.06				
	1.8 T	132		10.98	06.06				
	1.8 T	140		09.05	06.06				
	1.8 T Quattro	132		10.98	06.06		BAH0033	2	L=140
1.8 T Quattro	140		09.05	06.06					
1.8 T Quattro	165		10.98	06.06					
1.8 T Quattro	176		03.05	06.06					
3.2 Quattro	184		04.03	06.06					
<b>AUDI TT Roadster (99-06)</b>									
	1.8 T	110		01.01	06.06	PR: 1LD,1LT,1LV	BA2333		21911 20,3 + ATE
	1.8 T	120		09.05	06.06	PR: 1LD,1LT,1LV	BA2205		23392 20,6 +/WK ATE
	1.8 T	132		04.99	06.06	PR: 1LD,1LT,1LV			
	1.8 T	140		09.05	06.06	PR: 1LD,1LT,1LV			
	1.8 T Quattro	132		02.00	06.06	PR: 1LD,1LT,1LV			
	1.8 T Quattro	140		09.05	06.06	PR: 1LD,1LT,1LV			
	1.8 T Quattro	165		10.99	06.06	PR: 1LD,1LT,1LV			
	1.8 T	110		01.01	06.06	PR: 1LD,1LT,1LV	BAR25123		312 25,0 23,0 V L
	1.8 T	120		09.05	06.06	PR: 1LD,1LT,1LV			
	1.8 T	132		04.99	06.06	PR: 1LD,1LT,1LV			
	1.8 T	140		09.05	06.06	PR: 1LD,1LT,1LV			
	1.8 T Quattro	132		02.00	06.06	PR: 1LD,1LT,1LV			
	1.8 T Quattro	140		09.05	06.06	PR: 1LD,1LT,1LV			
	1.8 T Quattro	165		10.99	06.06	PR: 1LD,1LT,1LV			
	1.8 T	110	8N5-011 000	01.01	06.06	PR: 1KE,1KF,1KK,2EH	BA2017		20961 17,2/S LUC
	1.8 T	120	8N5-011 000	09.05	06.06	PR: 1KE,1KF,1KK,2EH	BA2032		20961 15,2/S LUC
	1.8 T	132	8N5-011 000	04.99	06.06	PR: 1KE,1KF,1KK,2EH			
	1.8 T	140	8N5-011 000	09.05	06.06	PR: 1KE,1KF,1KK,2EH			
	1.8 T Quattro	132	8N5-011 000	02.00	06.06	PR: 1KE,1KF,1KK,2EH			
	1.8 T Quattro	140	8N5-011 000	09.05	06.06	PR: 1KE,1KF,1KK,2EH			
	1.8 T Quattro	165	8N5-011 000	10.99	06.06	PR: 1KE,1KF,1KK,2EH			
	3.2 Quattro	184	8N5-011 000	04.03	06.06	PR: 1KE,1KF,1KK,2EH			
	1.8 T	110	8N5-011 001		06.06	PR: 1KE,1KF,1KK,2EH	BA2032		20961 15,2/S LUC
	1.8 T	120	8N5-011 001		06.06	PR: 1KE,1KF,1KK,2EH			
1.8 T	132	8N5-011 001		06.06	PR: 1KE,1KF,1KK,2EH				
1.8 T	140	8N5-011 001		06.06	PR: 1KE,1KF,1KK,2EH				
1.8 T Quattro	132	8N5-011 001		06.06	PR: 1KE,1KF,1KK,2EH				
1.8 T Quattro	140	8N5-011 001		06.06	PR: 1KE,1KF,1KK,2EH				
1.8 T Quattro	165	8N5-011 001		06.06	PR: 1KE,1KF,1KK,2EH				
3.2 Quattro	184	8N5-011 001		06.06	PR: 1KE,1KF,1KK,2EH				
	1.8 T	110		01.01	06.06	PR: 2EK	BA2017		20961 17,2/S LUC
	1.8 T	120		09.05	06.06	PR: 2EK			
	1.8 T	132		04.99	06.06	PR: 2EK			
	1.8 T	140		09.05	06.06	PR: 2EK			
	1.8 T Quattro	132		02.00	06.06	PR: 1KE	BAR09133		239 8,9 7,0
1.8 T Quattro	140		09.05	06.06	PR: 1KE				
1.8 T Quattro	165		10.99	06.06	PR: 1KE				
3.2 Quattro	184		04.03	06.06	PR: 1KE				
	1.8 T Quattro	132		02.00	06.06	PR: 1KF,2EH	BAR22163		256 22,0 20,0 V L
	1.8 T Quattro	140		09.05	06.06	PR: 1KF,2EH			
	1.8 T Quattro	165		10.99	06.06	PR: 1KF,2EH			
	3.2 Quattro	184		04.03	06.06	PR: 1KF,2EH			
	1.8 T	110		01.01	06.06		BAH0033	2	L=140
1.8 T	120		09.05	06.06					
1.8 T	132		04.99	06.06					
1.8 T	140		09.05	06.06					
	1.8 T Quattro	132		02.00	06.06		BAH0033	2	L=140
	1.8 T Quattro	140		09.05	06.06				
	1.8 T Quattro	165		10.99	06.06				
	3.2 Quattro	184		04.03	06.06				
	1.8 TFSI	118		06.08	06.06	PR: 1LJ,1LL	BAR25158		312 25,0 22,0 V L
2.0 quattro	195		05.08	06.06	PR: 1LJ,1LL				
2.0 TDI quattro	125		06.08	06.06	PR: 1LJ,1LL				
2.0 TFSI	147		07.06	06.06	PR: 1LJ,1LL				
2.0 TFSI	155		05.10	06.06	PR: 1LJ,1LL				
2.0 TFSI quattro	147		05.08	06.06	PR: 1LJ,1LL				
2.0 TFSI quattro	155		05.10	06.06	PR: 1LJ,1LL				
3.2 quattro	184		07.06	06.06	PR: 1LJ,1LL				
	1.8 TFSI	118		06.08	06.06	PR: 1KZ,2ED	BA2196		23914 16,3 /WE/S LUC
	2.0 quattro	195		05.08	06.06	PR: 1KJ,2EE			
	2.0 TDI quattro	125		06.08	06.06	PR: 1KJ,2EE			
	2.0 TFSI	147		07.06	06.06	PR: 1KZ,2ED			
	2.0 TFSI	155		05.10	06.06	PR: 1KZ,2ED			

										
<b>AUDI TT Coupe (06-)</b>										
	2.0 TFSI quattro	147		05.08	PR: 1KJ,2EE	BA2196		23914 16,3 /WE/S	LUC	
	2.0 TFSI quattro	155		05.10	PR: 1KJ,2EE					
	3.2 quattro	184		07.06	PR: 1KJ,2EE					
	TTS 2.0 TFSI	200		05.08	PR: 1KJ,2EE					
	RS 2.5 TFSI	250		05.09		BA2196		23914 16,3 /WE/S	LUC	
	RS 2.5 TFSI plus	265		05.11						
<b>AUDI TT Roadster (07-)</b>										
	1.8 TFSI	118		06.08	PR: 1LJ,1LL	BAR25158		312 25,0 22,0 V L		
	2.0 quattro	195		05.08	PR: 1LJ,1LL					
	2.0 TDI quattro	125		06.08	PR: 1LJ,1LL					
	2.0 TFSI	147		02.07	PR: 1LJ,1LL					
	2.0 TFSI	155		05.10	PR: 1LJ,1LL					
	2.0 TFSI quattro	147		05.08	PR: 1LJ,1LL					
	2.0 TFSI quattro	155		05.10	PR: 1LJ,1LL					
	3.2 quattro	184		02.07	PR: 1LJ,1LL					
	RS 2.5 TFSI	250		05.09	PR: 1LJ,1LL					
	1.8 TFSI	118		06.08	PR: 1KJ,2EE	BA2196		23914 16,3 /WE/S	LUC	
	2.0 quattro	195		05.08	PR: 1KJ,2EE					
	2.0 TDI quattro	125		06.08	PR: 1KJ,2EE					
	2.0 TFSI	147		02.07	PR: 1KJ,2EE					
	2.0 TFSI	155		05.10	PR: 1KJ,2EE					
	2.0 TFSI quattro	147		05.08	PR: 1KJ,2EE					
	2.0 TFSI quattro	155		05.10	PR: 1KJ,2EE					
	3.2 quattro	184		02.07	PR: 1KJ,2EE					
	RS 2.5 TFSI	250		05.09		BA2196		23914 16,3 /WE/S	LUC	
		RS 2.5 TFSI plus	265		02.12					
<b>BMW 1er Reihe/E81/E87 Limousine (04-11)</b>										
	120 d	120		09.04	02.07 + 5 türig <sup>1)</sup>	BA2311		- Performance Parts	23935 17,8 +/-WE	ATE
	120 i	110		09.04	12.05 + 5 türig <sup>1)</sup>	BAV1042	1		Warnkontakt L=644mm	
	116 d	85		03.09	02.10	BA2307		- Performance Parts	23915 17,8 +/-WE/S	LUC
	116 i	85		09.04	08.07	BAV1042	1		Warnkontakt L=644mm	
	116 i	90		09.07	12.08					
	116 i	90		01.09	02.10					
	118 d	90		09.04	03.07					
	118 d	105		04.07	02.10					
	118 i	95		09.04	03.07					
	118 i	105		04.07	02.10					
	120 i	110		01.06	03.07 + 5 türig <sup>1)</sup>					
	116 d	85		03.10	05.11	BA2307		- Performance Parts	23915 17,8 +/-WE/S	LUC
	116 i	90		03.10	05.11					
	118 d	105		03.10	05.11					
118 i	105		03.10	05.11						
120 d	120		09.04	02.07 + 3 türig <sup>2)</sup>	BA2252		- Performance Parts	23794 19,6 +/-WE	ATE	
120 d	130		03.07	02.10	BAV1042	1		Warnkontakt L=644mm		
120 i	110		09.04	03.07 + 3 türig <sup>2)</sup>						
120 i	125		04.07	02.10						
120 d	130		03.10	05.11	BA2252		- Performance Parts	23794 19,6 +/-WE	ATE	
120 i	125		03.10	05.11						
	116 d	85		03.09	02.10	BA2308		- Performance Parts	23623 17,4 +/-WE/S	LUC
	116 i	85		09.04	08.07	BAV1043	1		Warnkontakt L=1096mm	
	116 i	90		09.07	12.08					
	116 i	90		01.09	02.10					
	118 d	90		09.04	03.07 + 5 türig <sup>1)</sup>					
	118 i	95		09.04	03.07					
	118 i	105		04.07	02.10					
	120 i	110		09.04	03.07					
	120 i	125		04.07	02.10					
	116 d	85		03.10	05.11	BA2308		- Performance Parts	23623 17,4 +/-WE/S	LUC
	116 i	90		03.10	05.11					
	118 i	105		03.10	05.11					
	120 i	125		03.10	05.11					
	118 d	90		09.04	03.07 + 3 türig <sup>2)</sup>	BA2309		- Performance Parts	23926 17,3 +/-WE	ATE
	118 d	105		04.07	02.10	BAV1043	1		Warnkontakt L=1096mm	
	120 d	120		09.04	02.07					
120 d	130		03.07	02.10						
123 d	150		10.07	02.10						
130 i	190		03.05	08.05						
130 i	195		09.05	02.10						
118 d	105		03.10	05.11	BA2309		- Performance Parts	23926 17,3 +/-WE	ATE	
120 d	130		03.10	05.11						
123 d	150		03.10	05.11						
130 i	195		03.10	05.11						
<b>BMW 1er Reihe/E82 Coupe (07-)</b>										
	118 d			09.09	02.10	BA2307		- Performance Parts	23915 17,8 +/-WE/S	LUC
						BAV1042	1		Warnkontakt L=644mm	
	118 d			03.10		BA2307		- Performance Parts	23915 17,8 +/-WE/S	LUC
	120 d	130		10.07	02.10	BA2252		- Performance Parts	23794 19,6 +/-WE	ATE
	120 i	125		09.09	02.10	BAV1042	1		Warnkontakt L=644mm	
	125 i	160		03.08	02.10					
	120 d	130		03.10		BA2252		- Performance Parts	23794 19,6 +/-WE	ATE
	120 i	125		03.10						
	125 i	160		03.10						

<sup>1)</sup> + 5 door / + 5 porte / + 5 puertas



<sup>2)</sup> + 3 door / + 3 porte / + 3 puertas

									
<b>BMW 1er Reihe/E82 Coupe (07-)</b>									
	123 d 3.0 M	150 250	10.07 05.11	02.10	BAV1042 BA2245	1		Warnkontakt L=644mm 23312 19,6 +/-WE ATE	
	118 d 120 d 120 i 123 d 125 i	130 125 150 160	09.09 10.07 09.09 10.07 03.08	02.10 02.10 02.10 02.10 02.10	BA2309 BAV1043	1	- Performance Parts	23926 17,3 +/-WE ATE Warnkontakt L=1096mm	
	118 d 120 d 120 i 123 d 125 i	130 125 150 160	03.10 03.10 03.10 03.10 03.10		BA2309		- Performance Parts	23926 17,3 +/-WE ATE	
	135 i 3.0 M	225 250	10.07 05.11	02.10	BAV1043 BAV1043	1 1		Warnkontakt L=1096mm Warnkontakt L=1096mm	
<b>BMW 1er Reihe/E88 Cabrio (08-)</b>									
	118 d 118 i	105 105	09.08 03.08	02.10 02.10	BA2307 BAV1042	1	- Performance Parts	23915 17,8 +/-WE/S LUC Warnkontakt L=644mm	
	118 d 118 i	105 105	03.10 03.10		BA2307		- Performance Parts	23915 17,8 +/-WE/S LUC	
	120 d 120 i 125 i	130 125 160	03.10 03.10 03.10		BA2252		- Performance Parts	23794 19,6 +/-WE ATE	
	118 d 118 i 120 d 120 i 123 d 125 i	105 105 130 125 150 160	09.08 03.08 03.08 03.08 09.08 03.08	02.10 02.10 02.10 02.10 02.10 02.10	BA2309 BAV1043	1	- Performance Parts	23926 17,3 +/-WE ATE Warnkontakt L=1096mm	
	118 d 118 i 120 d 120 i 123 d 125 i	105 105 130 125 150 160	03.10 03.10 03.10 03.10 03.10 03.10		BA2309		- Performance Parts	23926 17,3 +/-WE ATE	
	135 i	225	03.08	02.10	BAV1043	1		Warnkontakt L=1096mm	
<b>BMW 3er Reihe/E36 (91-00)</b>									
	316 g Compact 316 i 316 i Compact 1.6 316 i Compact 1.9 316 i Coupe 316 i Touring 318 i 318 i Cabrio 318 i Touring 318 iS 318 iS Coupe 318 tds 318 tds Compact 318 tds Touring 318 ti Compact 320 i 320 i Cabrio 320 i Coupe 320 i Touring 323 i 323 i Cabrio 323 i Coupe 323 i Touring 323 ti Compact 325 i 325 i Cabrio 325 i Coupe 325 td 325 tds 325 tds Touring 328 i 328 i Cabrio 328 i Coupe 328 i Touring		12.95 12.90 09.93 12.98 03.93 05.97 12.90 11.93 02.95 01.92 01.92 01.94 04.94 10.94 04.94 12.90 11.93 01.92 05.94 03.95 03.95 03.95 07.95 08.97 12.90 08.92 01.92 09.91 03.93 10.94 11.94 11.94 10.94	08.00 02.98 08.00 08.00 04.99 10.99 02.98 04.99 10.99 02.98 04.99 02.98 08.00 10.99 08.00 02.98 04.99 04.99 10.99 02.98 04.99 04.99 10.99 08.00 02.98 03.95 04.99 04.99 10.99 08.00 02.98 03.95 04.99 04.99 02.98 10.99 02.98 04.99 04.99 10.99		BA2108 BAV1006	1		21643 17,8 +/-WE ATE Warnkontakt L=790mm
	M3 M3 Cabrio M3 Coupe		06.94 11.93 03.92	02.98 04.99 04.99	BA2125 BAV1031	1		20968 20,3 +/-WE ATE Warnkontakt L=810mm	
	316 g Compact 316 i 316 i Compact 1.6 316 i Compact 1.9 316 i Coupe 316 i Touring 318 i 318 i Cabrio 318 i Touring		12.95 12.90 09.93 12.98 03.93 05.97 12.90 11.93 02.95	08.00 02.98 08.00 08.00 04.99 10.99 02.98 04.99 10.99		BAR12126		286 11,9 10,4	
									

1) - authority cars / - enti statali / - véhicule communal / - vehiculos oficiales

















**BMW 3er Reihe/E36 (91-00)**

	318 tds	01.94	02.98	- Behörde <sup>1)</sup>	BAR12126		286 11,9 10,4
	318 tds Compact	04.94	08.00				
	318 tds Touring	10.94	10.99				
	318 ti Compact	04.94	03.98				
	316 i Touring	05.97	10.99	+ Behörde <sup>2)</sup>	BAR22115		286 22,0 20,4 V L
	318 i	12.90	02.98	+ Behörde <sup>2)</sup>			
	318 i Touring	02.95	10.99	+ Behörde <sup>2)</sup>			
	318 iS	01.92	02.98				
	318 iS Coupe	01.92	04.99				
	318 tds	01.94	02.98	+ Behörde <sup>2)</sup>			
	318 ti Compact	04.98	08.00				
	320 i	12.90	02.98				
	320 i Cabrio	11.93	04.99				
	320 i Coupe	01.92	04.99				
	320 i Touring	05.94	10.99				
	323 i	03.95	02.98				
	323 i Cabrio	03.95	04.99				
	323 i Coupe	03.95	04.99				
	323 i Touring	07.95	10.99				
	323 ti Compact	08.97	08.00				
325 i	12.90	02.98					
325 i Cabrio	08.92	03.95					
325 i Coupe	01.92	04.99					
325 td	09.91	02.98					
325 tds	03.93	02.98					
325 tds Touring	10.94	10.99					
328 i	11.94	02.98					
328 i Cabrio	11.94	04.99					
328 i Coupe	11.94	04.99					
328 i Touring	10.94	10.99					
	316 g Compact	12.95	08.00		BAH0001	2	L=425
	316 i	12.90	02.98				
	316 i Compact 1.6	09.93	08.00				
	316 i Compact 1.9	12.98	08.00				
	316 i Coupe	03.93	04.99				
	316 i Touring	05.97	10.99				
	318 i	12.90	02.98				
	318 i Cabrio	11.93	04.99				
	318 i Touring	02.95	10.99				
	318 iS	01.92	02.98				
	318 iS Coupe	01.92	04.99				
	318 tds	01.94	02.98				
	318 tds Compact	04.94	08.00				
	318 tds Touring	10.94	10.99				
	318 ti Compact	04.94	08.00				
	320 i	12.90	02.98				
	320 i Cabrio	11.93	04.99				
	320 i Coupe	01.92	04.99				
	320 i Touring	05.94	10.99				
	323 i	03.95	02.99				
	323 i Cabrio	03.95	04.99				
	323 i Coupe	03.95	04.99				
	323 i Touring	07.95	10.99				
	323 ti Compact	08.97	08.00				
	325 i	12.90	02.98				
	325 i Cabrio	08.92	03.95				
	325 i Coupe	01.92	04.99				
	325 td	09.91	02.98				
325 tds	03.93	02.98					
325 tds Touring	10.94	10.99					
328 i	11.94	02.98					
328 i Cabrio	11.94	04.99					
328 i Coupe	11.94	04.99					
328 i Touring	10.94	10.99					
	316 g Compact	12.95	08.00		BA2053 BAV1011	1	20180 17,3 +/-WE Warnkontakt L=840mm
	316 i Compact 1.6	09.93	08.00				
	316 i Compact 1.9	12.98	08.00				
	318 tds Compact	04.94	08.00				
	318 ti Compact	04.94	08.00				
	323 ti Compact	08.97	08.00				
	316 i	12.90	02.98		BA2053 BAV1005	1	20180 17,3 +/-WE Warnkontakt L=790mm
	316 i Touring	05.97	10.99				
	318 i	12.90	12.98				
	318 i Cabrio	11.93	04.99				
318 i Touring	02.95	10.99					
318 iS	01.92	02.98					
318 iS Coupe	01.92	04.99					
318 tds	01.94	02.98					
318 tds Touring	10.94	10.98					
320 i	12.90	02.98					
320 i Cabrio	11.93	04.99					
320 i Coupe	01.92	04.99					
320 i Touring	05.94	10.99					
323 i	03.95	02.98					
323 i Cabrio	03.95	04.99					
323 i Coupe	03.95	04.99					
323 i Touring	07.95	10.99					

<sup>1)</sup> - authority cars / - enti statali / - véhicule communal / - vehiculos oficiales

<sup>2)</sup> + authority cars / + enti statali / + véhicule communal / + vehiculos oficiales

        										
<b>BMW 3er Reihe/E36 (91-00)</b>										
	325 i 325 i Cabrio 325 i Coupe 325 td 325 tds 325 tds Touring 328 i 328 i Cabrio 328 i Coupe 328 i Touring	12.90 02.98 08.92 03.95 01.92 04.99 09.91 02.98 03.93 02.98 10.94 10.99 11.94 02.98 11.94 04.99 11.94 04.99 10.94 10.99	BA2053 BAV1005	1	20180 17,3 +/WE ATE Warnkontakt L=790mm					
	M3 M3 Cabrio M3 Coupe	06.94 02.98 11.93 04.99 03.92 04.99	BA2054 BAV1005	1	20995 17,3 +/WE ATE Warnkontakt L=790mm					
			316 g Compact 316 i Compact 1.6 316 i Compact 1.9 318 tds Compact 318 ti Compact 323 ti Compact	12.95 08.00 09.93 08.00 12.98 08.00 04.94 08.00 04.94 08.00 08.97 08.00	BAR10211		272 10,0 8,4 L			
			316 i 316 i Touring 318 i 318 i Cabrio 318 i Touring 318 iS 318 iS Coupe 318 tds 318 tds Touring 320 i 320 i Cabrio 320 i Coupe 320 i Touring 325 i 325 i Cabrio 325 i Coupe 325 td 325 tds 325 tds Touring 328 i 328 i Cabrio	12.90 02.98 05.97 10.99 12.90 02.98 11.93 04.99 02.95 10.99 01.92 02.98 01.92 04.99 01.94 02.98 10.94 10.99 12.90 02.98 11.93 04.99 01.92 04.99 05.94 10.99 12.90 02.98 08.92 03.95 01.92 04.99 09.91 02.98 03.93 02.98 10.94 10.99 11.94 02.98 11.94 04.99	BAR10202		280 10,0 8,4 L			
	323 i 323 i Cabrio 323 i Coupe 323 i Touring 328 i 328 i Cabrio 328 i Coupe 328 i Touring			03.95 02.98 03.95 04.99 03.95 04.99 07.95 10.99 11.94 02.98 11.94 04.99 11.94 04.99 10.94 10.99	BAR19107		276 19,0 17,4 V L			
					316 i 316 i 316 i Coupe 318 i 318 tds	12.90 02.98 12.91 02.98 03.93 04.99 12.90 02.98 01.94 02.98	BAW2301		Rz 23,81	
					316 g Compact 316 i Compact 1.6 318 tds Compact	12.95 08.00 09.93 08.00 04.94 08.00	BAW2202		Rz 22,20	
							316 g Compact 316 i 316 i Compact 1.6 316 i Coupe 318 i 318 tds 318 tds Compact	12.95 08.00 12.90 02.98 09.93 08.00 03.93 04.99 12.90 02.98 01.94 02.98 04.94 08.00	BAE5013	
		<b>BMW 3er Reihe/E46 (98-06)</b>								
					316 i 316 i 1.9 316 i Coupe 316 i Touring 316 ti Compact 318 Ci Cabrio 318 Ci Cabrio 318 d 318 d Touring 318 i 318 i Coupe 318 i Touring 318 td Compact 318 ti Compact 320 Cd Cabrio 320 Cd Coupe 320 Ci Cabrio 320 Ci Coupe 320 d 320 d 320 d Touring		77 85 85 105 110 85 85 110 110 125 100 110	12.98 02.05 12.98 02.05 04.00 08.05 03.02 07.05 07.01 02.05 09.01 12.06 02.05 12.06 09.01 02.05 03.02 07.05 04.98 02.05 08.99 08.05 10.99 07.05 03.03 02.05 09.01 02.05 02.05 12.06 11.03 08.06 10.00 12.06 06.99 08.06 04.98 09.01 09.01 02.05 03.00 07.05	BA2108 BAV1012	1
↓ ↓										

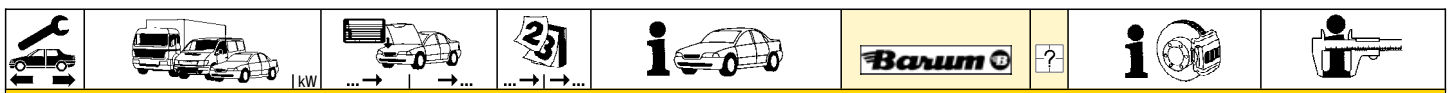

**BMW 3er Reihe/E46 (98-06)**

	320 i	110		04.98	09.00		BA2108			21643 17,8 +/WE Warnkontakt L=596mm	ATE		
	320 i	125		09.00	02.05		BAV1012	1					
	320 i Touring			10.99	07.05								
	320 td Compact			09.01	02.05								
	323 Ci Cabrio	125		05.00	12.06								
	323 Ci Coupe	125		04.99	08.00								
	323 i	125		04.98	08.00								
	325 Ci Cabrio	141		10.00	12.06								
	325 Ci Coupe	141		10.00	08.06								
	325 i	141		10.00	02.05	- Behörde 1)							
	325 i Touring	141		10.00	07.05								
	325 ti Compact	141		07.01	02.05								
	325 xi Touring	141		10.00	07.05								
	328 Ci Coupe	142		04.99	06.00								
	328 i	142		04.98	06.00								
	328 i Touring	142		10.99	06.00								
	325 xi	141		10.00	02.05	- Behörde 1)	BA2108 BAV1021	1				21643 17,8 +/WE Warnkontakt L=650mm	ATE
	325 i	141		10.00	02.05	+ Behörde 2)	BA2190					23183 20,3 +/WE	ATE
	325 xi	141		10.00	02.05	+ Behörde 2)	BAV1021	1				Warnkontakt L=650mm	
330 Cd Cabrio	150		05.05	12.06		BA2190			23183 20,3 +/WE	ATE			
330 Cd Coupe	150		03.03	08.06		BAV1021	1		Warnkontakt L=650mm				
330 Ci Cabrio	170		09.00	12.06									
330 Ci Coupe	170		09.00	08.06									
330 d			10.99	02.05									
330 d Touring			03.00	07.05									
330 i	170		09.00	02.05									
330 i Touring	170		06.00	07.05									
330 xd			10.99	02.05									
330 xd Touring			03.00	07.05									
330 xi	170		09.00	02.05									
330 xi Touring	170		09.00	07.05									
M3 Cabrio	252		05.01	12.06		BAV1021	1		Warnkontakt L=650mm				
M3 Coupe	252		06.00	08.06									
M3 CSL Coupe	265		05.03	08.06		BAV1021	1		Warnkontakt L=650mm				
	316 i			12.98	02.05		BAR22115			286 22,0 20,4 V L			
	316 i 1.9	77		12.98	02.05								
	316 i Coupe			04.00	08.06								
	316 i Touring	85		03.02	07.05								
	316 ti Compact	85		07.01	02.05								
	318 Ci Cabrio	105		09.01	12.06								
	318 Ci Cabrio	110		02.05	12.06								
	318 d	85		09.01	02.05								
	318 d Touring	85		03.02	07.05	- Behörde 1)							
	318 i			04.98	02.05	- Behörde 1)							
	318 i Coupe			08.99	08.06								
	318 i Touring			10.99	07.05	- Behörde 1)							
	318 td Compact			03.03	02.05								
	318 ti Compact			09.01	02.05								
	320 Ci Coupe			06.99	08.06								
	320 d	100		04.98	09.01								
	320 d Touring			03.00	08.01	- Behörde 1)							
	320 i	110		04.98	09.00	- Behörde 1)							
	320 i	125		09.00	02.05	- Behörde 1)							
	320 i Touring			10.99	07.05	- Behörde/ + Motorcode M52 3)							
	323 Ci Coupe	125		04.99	08.00								
	323 i	125		04.98	08.00	- Behörde 1)							
	318 d Touring	85		03.02	07.05	+ Behörde 2)	BAR22160				300 22,0 20,4 V L		
	318 i			04.98	02.05	+ Behörde 2)							
	318 i Touring			10.99	07.05	+ Behörde 2)							
	320 Cd Cabrio	110		02.05	12.06								
	320 Cd Coupe	110		11.03	08.06								
	320 Ci Cabrio	125		10.00	12.06								
	320 d	110		09.01	02.05								
	320 d Touring			09.01	07.05	- Behörde 1)							
	320 d Touring			03.00	07.05	+ Behörde 2)							
	320 i	110		04.98	09.00	+ Behörde 2)							
	320 i	125		09.00	02.05	+ Behörde 2)							
320 i Touring			10.99	07.05	+ Behörde/ + Motorcode M52 4)								
320 i Touring			10.99	07.05	+ Motorcode M54 5)								
320 td Compact			09.01	02.05									
323 Ci Cabrio	125		05.00	08.00									
323 i	125		04.98	08.00	+ Behörde 2)								
325 Ci Cabrio	141		10.00	12.06									
325 Ci Coupe	141		10.00	08.06									
325 i	141		10.00	02.05	- Behörde 1)								
325 i Touring	141		10.00	07.05									
325 ti Compact	141		07.01	02.05									
325 xi	141		10.00	02.05	- Behörde 1)								
325 xi Touring	141		10.00	07.05									
328 Ci Coupe	142		04.99	06.00									
328 i	142		04.98	06.00									
328 i Touring	142		10.99	06.00									
325 i	141		10.00	02.05	+ Behörde 2)	BAR25138			325 25,0 23,4 V L				
325 xi	141		10.00	02.05	+ Behörde 2)								
330 Cd Cabrio	150		05.05	12.06									

1) - authority cars / - enti statali / - véhicule communal / - vehiculos oficiales

2) + authority cars / + enti statali / + véhicule communal / + vehiculos oficiales

3) - authority cars/+engine co.M52 / - enti statali/+codice mot.M52 / - véhicule communal/+moteur co.M52 / - vehiculos oficiales/+motor co.M52

4) + authority cars/+engine no.M52 / + enti statali/+codice mot.M52 / + véhicule communal/+moteur co.M52 / + vehiculos oficiales/+motor co.M52

5) + engine code M54 / + codice motore M54 / + moteur code M54 / + motor code M54

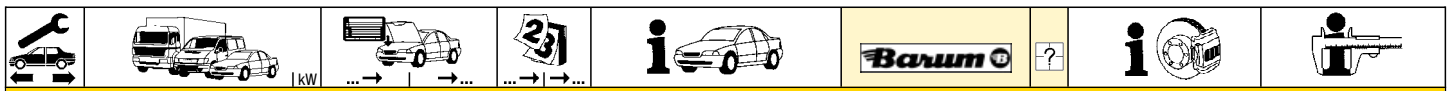

**BMW 3er Reihe/E46 (98-06)**

	330 Cd Coupe 150 330 Ci Cabrio 170 330 Ci Coupe 170 330 d 330 d Touring 330 i 170 330 i Touring 170 330 xd 330 xd Touring 330 xi 170 330 xi Touring 170		03.03 08.06 09.00 12.06 09.00 08.06 10.99 02.05 03.00 07.05 09.00 02.05 06.00 07.05 10.99 02.05 03.00 07.05 09.00 02.05 09.00 07.05	BAR25138		325 25,0 23,4 V L
	316 i 316 i 1.9 77 316 i Coupe 316 i Touring 85 316 ti Compact 85 318 Ci Cabrio 105 318 Ci Cabrio 110 318 d 85 318 d Touring 85 318 i 318 i Coupe 318 i Touring 318 td Compact 318 ti Compact 320 Cd Cabrio 110 320 Cd Coupe 110 320 Ci Cabrio 125 320 Ci Coupe 320 d 100 320 d 110 320 d Touring 320 i 110 320 i 125 320 i Touring 320 td Compact 323 Ci Cabrio 125 323 Ci Coupe 125 323 i 125 325 Ci Cabrio 141 325 Ci Coupe 141 325 i 141 325 i Touring 141 325 ti Compact 141 328 Ci Coupe 142 328 i 142 328 i Touring 142 330 Cd Cabrio 150 330 Cd Coupe 150 330 Ci Cabrio 170 330 Ci Coupe 170 330 d 330 d Touring 330 i 170 330 i Touring 170		12.98 02.05 12.98 02.05 04.00 08.06 03.02 07.05 07.01 02.05 09.01 12.06 02.05 12.06 09.01 02.05 03.02 07.05 04.98 02.05 08.99 08.06 10.99 07.05 03.03 02.05 09.01 02.05 02.05 12.06 11.03 08.06 10.00 12.06 06.99 08.06 04.98 09.01 09.01 02.05 03.00 07.05 04.98 09.00 09.00 02.05 10.99 07.05 09.01 02.05 05.00 08.00 04.99 08.00 04.98 08.00 10.00 12.06 10.00 08.06 10.00 02.05 10.00 07.05 07.01 02.05 04.99 06.00 04.98 06.00 10.99 06.00 05.05 12.06 03.03 08.06 09.00 12.06 09.00 08.06 10.99 02.05 03.00 07.05 09.00 02.05 06.00 07.05	BAH0017	2	L=410
	316 i 316 i 1.9 77 316 i Coupe 316 i Touring 85 316 ti Compact 85 318 Ci Cabrio 105 318 Ci Cabrio 110 318 d 85 318 d Touring 85 318 i 318 i Coupe 318 i Touring 318 td Compact 318 ti Compact 320 Cd Cabrio 110 320 Cd Coupe 110 320 Ci Cabrio 125 320 Ci Coupe 320 d 100 320 d 110 320 d Touring 320 i 110 320 i 125 320 i Touring 320 td Compact 323 Ci Cabrio 125 323 Ci Coupe 125 323 i 125 325 Ci Cabrio 141 325 Ci Coupe 141 325 i 141 325 i Touring 141 325 ti Compact 141 328 Ci Coupe 142 328 i 142 328 i Touring 142 330 Cd Cabrio 150 330 Cd Coupe 150 330 Ci Cabrio 170 330 Ci Coupe 170 330 d 330 d Touring 330 i 170 330 i Touring 170		12.98 02.05 12.98 02.05 04.00 08.06 03.02 07.05 07.01 02.05 09.01 12.06 02.05 12.06 09.01 02.05 03.02 07.05 04.98 02.05 08.99 08.06 10.99 07.05 03.03 02.05 09.01 02.05 02.05 12.06 11.03 08.06 10.00 12.06 06.99 08.06 04.98 09.01 09.01 02.05 03.00 07.05 04.98 09.00 09.00 02.05 10.99 07.05 09.01 02.05 05.00 12.06 04.99 08.00 04.98 08.00 10.00 12.06 10.00 08.06 10.00 02.05 10.00 07.05 07.01 02.05 04.99 06.00 04.98 06.00 10.99 06.00 05.05 12.06 03.03 08.06 09.00 12.06 09.00 08.06 10.99 02.05 03.00 07.05 09.00 02.05 06.00 07.05	BA2053 BAV1013	1	20180 17,3 +-WE ATE Warnkontakt L=1334mm
			10.00 07.05 - Behörde <sup>1)</sup>			

1) - authority cars / - enti statali / - véhicule communal / - vehiculos oficiales

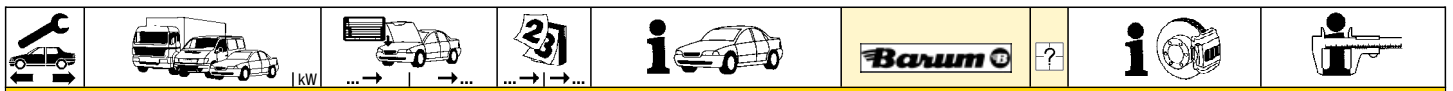

**BMW 3er Reihe/E46 (98-06)**

	325 ti Compact	141	07.01	02.05	BA2053 BAV1013	1	20180 17,3 +/WE Warnkontakt L=1334mm	ATE	
	325 xi	141	10.00	02.05					- Behörde 1)
	325 xi Touring	141	10.00	07.05					
	328 Ci Coupe	142	04.99	06.00					
	328 i	142	04.98	06.00					
	328 i Touring	142	10.99	06.00					
	325 i	141	10.00	02.05					+ Behörde 2)
	325 xi	141	10.00	02.05					+ Behörde 2)
	330 Cd Cabrio	150	05.05	12.06					
	330 Cd Coupe	150	03.03	08.06					
330 Ci Cabrio	170	09.00	12.06						
330 Ci Coupe	170	09.00	08.06						
330 d		10.99	02.05						
330 d Touring		03.00	07.05						
330 i	170	09.00	02.05						
330 i Touring	170	06.00	07.05						
330 xd		10.99	02.05						
330 xd Touring		03.00	07.05						
330 xi	170	09.00	02.05						
330 xi Touring	170	09.00	07.05						
M3 Cabrio	252	05.01	12.06	BA2167		21487 17,3 +/WE	ATE		
M3 Coupe	252	06.00	08.06						
M3 CSL Coupe	265	05.03	08.06						
	316 i		12.98	02.05	BAR10202		280 10,0 8,4 L		
	316 i 1.9	77	12.98	02.05					- Behörde 1)
	316 i Coupe		04.00	08.06					
	316 ti Compact	85	07.01	02.05					
	318 i		04.98	02.05					+ Motorcode M43 3)
	318 i Coupe		08.99	08.06					+ Motorcode M43 3)
	316 i 1.9	77	12.98	02.05					+ Behörde 2)
	316 i Touring	85	03.02	07.05					
	318 Ci Cabrio	105	09.01	12.06					
	318 Ci Cabrio	110	02.05	12.06					
318 d	85	09.01	02.05						
318 d Touring	85	03.02	07.05	- Behörde 1)					
318 i		04.98	02.05	- Behörde / + Motorcode N42/N46 4)					
318 i Coupe		08.99	08.06	+ Motorcode N42/N46 5)					
318 i Touring		10.99	07.05	- Behörde 1)					
318 td Compact		03.03	02.05						
318 ti Compact		09.01	02.05						
320 Ci Coupe		06.99	08.06						
320 d	100	04.98	09.01						
320 d Touring		03.00	08.01	- Behörde 1)					
320 i	110	04.98	09.00	- Behörde 1)					
320 i	125	09.00	02.05	- Behörde 1)					
320 i Touring		10.99	07.05	- Behörde/ + Motorcode M52 6)					
323 Ci Coupe	125	04.99	08.00						
323 i	125	04.98	08.00	- Behörde 1)					
318 d Touring	85	03.02	07.05	+ Behörde 2)					
318 i		04.98	02.05	+ Behörde 2)					
318 i Touring		10.99	07.05	+ Behörde 2)					
320 Cd Cabrio	110	02.05	12.06						
320 Cd Coupe	110	11.03	08.06						
320 Ci Cabrio	125	10.00	12.06						
320 d	110	09.01	02.05						
320 d Touring		09.01	07.05	- Behörde 1)					
320 d Touring		03.00	07.05	+ Behörde 2)					
320 i	110	04.98	09.00	+ Behörde 2)					
320 i	125	09.00	02.05	+ Behörde 2)					
320 i Touring		10.99	07.05	+ Behörde/ + Motorcode M52 7)					
320 i Touring		10.99	07.05	+ Motorcode M54 8)					
320 td Compact		09.01	02.05						
323 Ci Cabrio	125	05.00	08.00						
323 i	125	04.98	08.00	+ Behörde 2)					
325 Ci Cabrio	141	10.00	12.06						
325 Ci Coupe	141	10.00	08.06						
325 i	141	10.00	02.05						
325 i Touring	141	10.00	07.05						
325 ti Compact	141	07.01	02.05						
328 Ci Coupe	142	04.99	06.00						
328 i	142	04.98	06.00						
328 i Touring	142	10.99	06.00						
325 xi	141	10.00	02.05	+ Behörde 2)					
330 Cd Cabrio	150	05.05	12.06						
330 Cd Coupe	150	03.03	08.06						
330 Ci Cabrio	170	09.00	12.06						
330 Ci Coupe	170	09.00	08.06						
330 d		10.99	02.05						
330 d Touring		03.00	07.05						
330 i	170	09.00	02.05						
330 i Touring	170	06.00	07.05						
330 xd		10.99	02.05						
330 xd Touring		03.00	07.05						
330 xi	170	09.00	02.05						
330 xi Touring	170	09.00	07.05						

1) - authority cars / - enti statali / - véhicule communal / - vehiculos oficiales

2) + authority cars / + enti statali / + véhicule communal / + vehiculos oficiales

3) + engine code M43 / + codice motore M43 / + moteur code M43 / + motor code M43

4) - authority cars/+engine co.N42/N46 / - enti statali/+codice mot.N42/N46 / - véhicule communal/+moteur co.N42/N46 / - vehiculos oficiales/+motor co.N42/N46

5) + engine code N42/N46 / + codice motore N42/N46 / + moteur code N42/N46 / + motor code N42/N46

6) - authority cars/+engine co.M52 / - enti statali/+codice mot.M52 / - véhicule communal/+moteur co.M52 / - vehiculos oficiales/+motor co.M52

7) + authority cars/+engine no.M52 / + enti statali/+codice mot.M52 / + véhicule communal/+moteur co.M52 / + vehiculos oficiales/+motor co.M52

8) + engine code M54 / + codice motore M54 / + moteur code M54 / + motor code M54

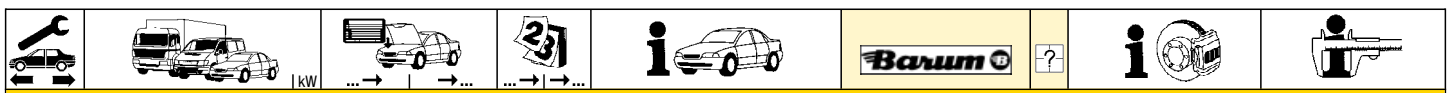

**BMW 3er Reihe/E90 Limousine (05-)**

	316 i	85	01.05	08.07		BA2311		1	23935 17,8 +/WE	ATE Warnkontakt L=644mm
	318 d	90	09.05	08.07	- erhöhte Zuladung <sup>1)</sup>	BAV1042				
	318 i	95	09.05	08.07	+ erhöhte Zuladung/ + Motorcode N46 <sup>2)</sup>					
	320 i		12.04	08.07	- erhöhte Zuladung/ + Motorcode N46 <sup>2)</sup>					
	316 d	85	07.09	02.10		BA2252		1	23794 19,6 +/WE	ATE Warnkontakt L=644mm
	316 i	90	09.07	02.10		BAV1042				
	318 d		09.07	02.10						
	318 d	90	09.05	08.07	+ erhöhte Zuladung <sup>3)</sup>					
	318 i	95	09.05	08.07	+ erhöhte Zuladung/ + Motorcode N46 <sup>4)</sup>					
	318 i	95	03.07	08.07	- erhöhte Zuladung/ + Motorcode N46N <sup>5)</sup>					
	318 i	105	09.07	02.10						
	320 d	120	12.04	08.07	- Behörde <sup>6)</sup>					
	320 i		12.04	08.07	+ erhöhte Zuladung/ + Motorcode N46 <sup>4)</sup>					
	320 i		03.07	08.07	- erhöhte Zuladung/ + Motorcode N46N <sup>5)</sup>					
	320 i	125	09.07	02.10	- erhöhte Zuladung <sup>1)</sup>					
	320 si	127	06.06	02.10						
	325 d	145	09.06	02.10	- Behörde <sup>6)</sup>					
	325 i	160	12.04	08.07	- erhöhte Zuladung/ + Motorcode N52 <sup>7)</sup>					
	316 d	85	03.10			BA2252			23794 19,6 +/WE	ATE
	316 i	90	03.10							
318 d		03.10								
318 i	105	03.10		- erhöhte Zuladung <sup>1)</sup>						
320 i	125	03.10								
320 si	127	03.10		- Behörde <sup>6)</sup>						
330 i	190	12.04	08.07	- erhöhte Zuladung/ + Motorcode N52 <sup>7)</sup>	BA2252		1	23794 19,6 +/WE	ATE Warnkontakt L=644mm	
330 i	190	12.04	08.07	+ Motorcode N52N <sup>8)</sup>	BAV1042					
318 i	95	03.07	08.07	+ erhöhte Zuladung/ + Motorcode N46N <sup>9)</sup>	BAV1042		1	Warnkontakt L=644mm		
320 d	110	09.05	02.10	+ Behörde <sup>10)</sup>	BA2252			23794 19,6 +/WE	ATE	
320 d	120	12.04	08.07	+ Behörde <sup>10)</sup>						
320 d	130	09.07	02.10	+ Behörde <sup>10)</sup>						
320 xd		09.07	02.10	+ Behörde <sup>10)</sup>						
325 i	160	12.04	02.10	+ erhöhte Zuladung <sup>3)</sup>						
320 d	110	03.10		+ Behörde <sup>10)</sup>	BA2252			23794 19,6 +/WE	ATE	
320 d	130	03.10		+ Behörde <sup>10)</sup>						
320 xd		03.10		+ Behörde <sup>10)</sup>						
325 i	160	03.10		+ erhöhte Zuladung <sup>3)</sup>						
330 d	170	09.05	08.07		BA2252			23794 19,6 +/WE	ATE	
330 i	190	12.04	08.07	+ erhöhte Zuladung/ + Motorcode N52 <sup>11)</sup>						
325 xi	160	01.05	08.07	+ Motorcode N52	BA2252			23794 19,6 +/WE	ATE	
325 xi	160	01.05	08.07	+ erhöhte Zuladung/ + Motorcode N52N						
325 xi	160	09.07	02.10	+ erhöhte Zuladung/ + Motorcode N53						
325 xi	160	03.10		+ erhöhte Zuladung/ + Motorcode N53	BA2252			23794 19,6 +/WE	ATE	
330 xd	170	09.05	08.07		BA2252			23794 19,6 +/WE	ATE	
330 xi	190	01.05	08.07					23794 19,6 +/WE	ATE	
330 xi	200	09.07	02.10	- erhöhte Zuladung <sup>1)</sup>						
330 xi	200	03.10		- erhöhte Zuladung <sup>1)</sup>	BA2252					
M3	309	12.07			BA2245			23312 19,6 +/WE	ATE	
	316 d	85	07.09	02.10		BA2308		1	23623 17,4 +/WE/S	LUC Warnkontakt L=1096mm
	316 i	85	01.05	08.07		BAV1043				
	316 i	90	09.07	02.10						
	318 d	90	09.05	08.07	- erhöhte Zuladung <sup>1)</sup>					
	318 i	95	09.05	08.07	- erhöhte Zuladung/ + Motorcode N46 <sup>2)</sup>					
	320 i		12.04	08.07	- erhöhte Zuladung/ + Motorcode N46 <sup>2)</sup>					
	316 d	85	03.10			BA2308			23623 17,4 +/WE/S	LUC
	316 i	90	03.10							
	318 d		09.07	02.10		BA2309		1	23926 17,3 +/WE	ATE Warnkontakt L=1096mm
	318 d	90	09.05	08.07	+ erhöhte Zuladung <sup>3)</sup>	BAV1043				
	318 i	95	09.05	08.07	+ erhöhte Zuladung/ + Motorcode N46 <sup>4)</sup>					
	318 i	95	03.07	08.07	+ Motorcode N46N					
	318 i	105	09.07	02.10						
	320 d	110	09.05	02.10	- Behörde <sup>6)</sup>					
	320 d	120	12.04	08.07						
	320 d	130	09.07	02.10	- Behörde <sup>6)</sup>					
	320 i		12.04	08.07	+ erhöhte Zuladung/ + Motorcode N46 <sup>4)</sup>					
	320 i		03.07	08.07	+ Motorcode N46N					
	320 i	125	09.07	02.10						
	320 si	127	06.06	02.10						
	320 xd		09.07	02.10	- Behörde <sup>6)</sup>					
	325 i	160	12.04	02.10	- erhöhte Zuladung <sup>1)</sup>					
	325 xi	160	01.05	02.10	- erhöhte Zuladung <sup>1)</sup>					
	318 d		03.10			BA2309			23926 17,3 +/WE	ATE
	318 i	105	03.10							
	320 d	110	03.10		- Behörde <sup>6)</sup>					
	320 d	130	03.10		- Behörde <sup>6)</sup>					
	320 i	125	03.10							
	320 si	127	03.10							
	320 xd		03.10		- Behörde <sup>6)</sup>					
	325 i	160	03.10		- erhöhte Zuladung <sup>1)</sup>					
	325 xi	160	03.10		- erhöhte Zuladung <sup>1)</sup>					
	320 d	110	09.05	02.10	+ Behörde <sup>10)</sup>	BAV1043		1	Warnkontakt L=1096mm	
	320 d	130	09.07	02.10	+ Behörde <sup>10)</sup>					
320 xd		09.07	02.10	+ Behörde <sup>10)</sup>						
325 d	145	09.06	02.10							

1) - increased payload / - carico utile maggiorato / - charge utile augmentée / - incremento de carga  
 2) - increased payload/+engine co.N46 / - carico utile maggior./+codic.mot.N46 / - charge utile augmentée/+moteur co.N46 / - incremento de carga/+motor co.N46  
 3) + increased payload / + carico utile maggiorato / + charge utile augmentée / + incremento de carga  
 4) + increased payload/+engine co.N46 / + carico utile maggior./+codic.mot.N46 / + charge utile augmentée/+moteur co.N46 / + incremento de carga/+motor co.N46  
 5) - increased payload/+engine co.N46N / - carico utile maggior./+codic.mot.N46N / - charge utile augmentée/+moteur co.N46N / - incremento de carga/+motor co.N46N

6) - authority cars / - enti statali / - véhicule communal / - vehiculos oficiales  
 7) - increased payload/+engine co.N52 / - carico utile maggior./+codic.mot.N52 / - charge utile augmentée/+moteur co.N52 / - incremento de carga/+motor co.N52  
 8) + engine code N52N / + codice motore N52N / + moteur code N52N / + motor code N52N  
 9) + increased payload/+engine co.N46N / + carico utile maggior./+codic.mot.N46N / + charge utile augmentée/+moteur co.N46N / + incremento de carga/+motor co.N46N  
 10) + authority cars / + enti statali / + véhicule communal / + vehiculos oficiales  
 11) + increased payload/+engine co.N52 / + carico utile maggior./+codic.mot.N52 / + charge utile augmentée/+moteur co.N52 / + incremento de carga/+motor co.N52

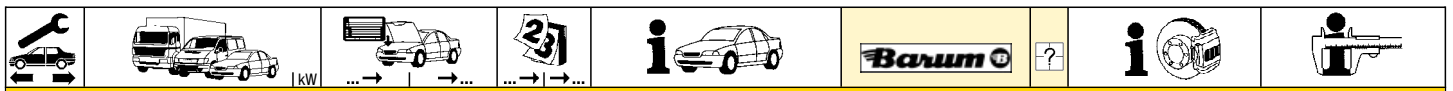

**BMW 3er Reihe/E90 Limousine (05-)**















	325 i	160	12.04	02.10	+ erhöhte Zuladung <sup>1)</sup>	BAV1043	1	Warnkontakt L=1096mm
	325 xi	160	01.05	02.10	+ erhöhte Zuladung <sup>1)</sup>			
	330 d	170	09.05	02.10				
	330 d	180	09.08	02.10				
	330 i	190	12.04	08.07				
	330 i	200	09.07	02.10				
	330 xd	170	09.05	02.10				
	330 xd	180	01.09	02.10				
	330 xi	190	01.05	08.07				
	330 xi	200	09.07	02.10				
	335 d	210	09.06	02.10				
	335 i	225	09.06	02.10				
	335 xi	225	03.07	02.10				
	M3	309	12.07	02.10				

**BMW 3er Reihe/E91 Touring (05-)**

	316 d	85	09.09	02.10		BA2252 BAV1042	1	23794 19,6 +/-WE Warnkontakt L=644mm	ATE				
	318 d	90	09.05	08.07									
	318 i		01.06	08.07	+ Motorcode N46 <sup>2)</sup>								
	318 i	100	03.08	02.10	- erhöhte Zuladung <sup>3)</sup>								
	318 i	105	03.08	02.10	- erhöhte Zuladung <sup>3)</sup>								
	320 d	120	06.05	08.07									
	320 i		06.05	08.07	+ Motorcode N46 <sup>2)</sup>								
	323 i		06.05	02.10									
	325 d	145	09.06	02.10	- Behörde <sup>4)</sup>								
	325 i	160	06.05	08.07	+ Motorcode N52 <sup>5)</sup>								
	316 d	85	03.10							BA2252		23794 19,6 +/-WE	ATE
	318 i	100	03.10		- erhöhte Zuladung <sup>3)</sup>								
	318 i	105	03.10		- erhöhte Zuladung <sup>3)</sup>								
	323 i		03.10										
325 d	145	03.10		- Behörde <sup>4)</sup>									
330 d	170	06.05	08.07		BA2252 BAV1042	1	23794 19,6 +/-WE Warnkontakt L=644mm	ATE					
330 i	190	06.05	08.07										
325 i	160	03.07	08.07	+ erhöhte Zuladung/ + Motorcode N52N <sup>6)</sup>	BA2252		23794 19,6 +/-WE	ATE					
325 xi	160	06.05	02.10	+ Motorcode N52N/N53 <sup>7)</sup>									
325 xi	160	03.07	08.07	+ erhöhte Zuladung/ + Motorcode N52N <sup>6)</sup>									
325 xi	160	03.10		+ Motorcode N52N/N53 <sup>7)</sup>	BA2252		23794 19,6 +/-WE	ATE					
330 xd	170	06.05	08.07										
330 xi	190	06.05	08.07		BA2252		23794 19,6 +/-WE	ATE					
320 d		09.07	02.10	+ Behörde <sup>8)</sup>									
320 d	120	09.07	02.10	+ Behörde <sup>8)</sup>									
320 xd	130	09.07	02.10	+ Behörde <sup>8)</sup>									
325 i	160	09.07	02.10	+ erhöhte Zuladung/ + Motorcode N53 <sup>9)</sup>									
320 d		03.10		+ Behörde <sup>8)</sup>									
320 d	120	03.10		+ Behörde <sup>8)</sup>									
320 xd	130	03.10		+ Behörde <sup>8)</sup>									
325 i	155	01.12		+ erhöhte Zuladung <sup>1)</sup>									
325 i	160	03.10		+ erhöhte Zuladung/ + Motorcode N53 <sup>9)</sup>									
	316 d	85	09.09	02.10		BA2309 BAV1043	1	23926 17,3 +/-WE Warnkontakt L=1096mm	ATE				
	318 d	90	09.05	08.07									
	318 d	105	09.07	02.10									
	318 i		01.06	08.07									
	318 i	100	09.07	02.10									
	318 i	105	09.07	02.10									
	320 d		09.07	02.10	- Behörde <sup>4)</sup>								
	320 d	120	06.05	02.10	- Behörde <sup>4)</sup>								
	320 i		06.05	08.07									
	320 i	125	09.07	02.10									
	320 xd	130	09.07	02.10	- Behörde <sup>4)</sup>								
	323 i		06.05	02.10									
	325 i	160	06.05	02.10	- erhöhte Zuladung <sup>3)</sup>								
	325 xi	160	03.07	08.07	- erhöhte Zuladung/ + Motorcode N52N <sup>10)</sup>								
316 d	85	03.10			BA2309		23926 17,3 +/-WE	ATE					
318 d	105	03.10											
318 i	100	03.10											
318 i	105	03.10											
320 d		03.10		- Behörde <sup>4)</sup>									
320 d	120	03.10		- Behörde <sup>4)</sup>									
320 i	125	03.10											
320 xd	130	03.10		- Behörde <sup>4)</sup>									
323 i		03.10											
325 i	155	01.12		- erhöhte Zuladung <sup>3)</sup>									
325 i	160	03.10		- erhöhte Zuladung <sup>3)</sup>									
320 d		09.07	02.10	+ Behörde <sup>8)</sup>					BAV1043	1	Warnkontakt L=1096mm		
320 d	120	06.05	02.10	+ Behörde <sup>8)</sup>									
320 xd	130	09.07	02.10	+ Behörde <sup>8)</sup>									
325 d	145	09.06	02.10										
325 i	160	06.05	02.10	+ erhöhte Zuladung <sup>1)</sup>									
325 xi	160	06.05	02.10	+ Motorcode N52N/N53 <sup>7)</sup>									
325 xi	160	03.07	08.07	+ erhöhte Zuladung/ + Motorcode N52N <sup>6)</sup>									
330 d	170	06.05	02.10										
330 d	180	09.08	02.10										
330 i	190	06.05	08.07										
330 i	200	09.07	02.10										
330 xd	170	06.05	02.10										

1) + increased payload / + carico utile maggiorato / + charge utile augmentée / + incremento de carga  
 2) + engine code N46 / + codice motore N46 / + moteur code N46 / + motor code N46  
 3) - increased payload / - carico utile maggiorato / - charge utile augmentée / - incremento de carga  
 4) - authority cars / - enti statali / - véhicule communal / - vehiculos oficiales  
 5) + engine code N52 / + codice motore N52 / + moteur code N52 / + motor code N52  
 6) + increased payload/+engine co.N52N / + carico utile maggior./+codic.mot.N52N / + charge utile augmentée/+moteur co.N52N / + incremento de carga/+motor co.N52N  
 7) + engine code N52N/N53 / + codice motore N52N/N53 / + moteur code N52N/N53 / + motor code N52N/N53

8) + authority cars / + enti statali / + véhicule communal / + vehiculos oficiales  
 9) + increased payload/+engine co.N53 / + carico utile maggior./+codic.mot.N53 / + charge utile augmentée/+moteur co.N53 / + incremento de carga/+motor co.N53  
 10) - increased payload/+engine co.N52N / - carico utile maggior./+codic.mot.N52N / - charge utile augmentée/+moteur co.N52N / - incremento de carga/+motor co.N52N

															
<b>BMW 3er Reihe/E91 Touring (05-)</b>															
	330 xi	190		06.05	08.07			BAV1043		1					Warnkontakt L=1096mm
	330 xi	200			09.07	02.10									
	335 d	210			09.06	02.10									
	335 i	225			09.06	02.10									
	335 xi	225			03.07	02.10									
<b>BMW 3er Reihe/E92 Coupe (06-)</b>															
	320 i	125		03.07	02.10			BA2252						23794 19,6 +/WE	ATE
	323 i			09.06	02.10			BAV1042		1				Warnkontakt L=644mm	
	325 d	145		03.07	02.10										
	325 i	160		09.06	02.10	+ Motorcode N53 <sup>1)</sup>									
	325 i	160		09.06	08.07	+ Motorcode N52N <sup>2)</sup>									
	325 xi	160		09.06	08.07	+ Motorcode N52N <sup>2)</sup>									
	318 i	105		03.10				BA2252						23794 19,6 +/WE	ATE
	320 i	125		03.10											
	323 i			03.10											
	325 d	145		03.10											
	325 i	160		03.10		+ Motorcode N53 <sup>1)</sup>									
	330 i	200		09.06	02.10	+ Motorcode N52N <sup>2)</sup>		BA2252						23794 19,6 +/WE	ATE
								BAV1042		1				Warnkontakt L=644mm	
	330 i	200		03.10		+ Motorcode N52N <sup>2)</sup>		BA2252						23794 19,6 +/WE	ATE
	325 xi	160		09.06	02.10	+ Motorcode N53 <sup>1)</sup>		BA2252						23794 19,6 +/WE	ATE
	325 xi	160		03.10		+ Motorcode N53 <sup>1)</sup>		BA2252						23794 19,6 +/WE	ATE
	330 xi	200		09.06	02.10			BA2252						23794 19,6 +/WE	ATE
	330 xi	200		03.10				BA2252						23794 19,6 +/WE	ATE
	M3	309		03.07				BA2245						23312 19,6 +/WE	ATE
	320 d	130		03.07	02.10			BA2309						23926 17,3 +/WE	ATE
	320 i	125		03.07	02.10			BAV1043		1				Warnkontakt L=1096mm	
	320 xd	130		03.07	02.10										
	323 i			09.06	02.10										
	325 i	160		09.06	02.10										
	325 xi	160		09.06	02.10										
	318 i	105		03.10				BA2309						23926 17,3 +/WE	ATE
	320 d	130		03.10											
	320 i	125		03.10											
	320 xd	130		03.10											
	323 i			03.10											
	325 i	160		03.10											
	325 xi	160		03.10											
	325 d	145		03.07	02.10			BAV1043		1				Warnkontakt L=1096mm	
	330 d	170		09.06	02.10										
	330 d	180		09.08	02.10										
	330 i	200		09.06	02.10										
	330 xd	170		09.06	02.10										
	330 xi	200		09.06	02.10										
	335 d	210		09.06	02.10										
	335 i	225		09.06	02.10										
	335 xi	225		09.07	02.10										
	M3	309		03.07	02.10			BAV1043		1				Warnkontakt L=1096mm	
<b>BMW 3er Reihe/E93 Cabrio (07-)</b>															
	330 i	200		03.07	02.10	+ Motorcode N52N <sup>2)</sup>		BA2252						23794 19,6 +/WE	ATE
								BAV1042		1				Warnkontakt L=644mm	
	318 i	105		03.10				BA2252						23794 19,6 +/WE	ATE
	325 d	145		09.07											
	325 d	150		03.10											
	330 i	200		03.10		+ Motorcode N52N <sup>2)</sup>									
	M3	309		03.08				BA2245						23312 19,6 +/WE	ATE
	320 d	130		03.08	02.10			BA2309						23926 17,3 +/WE	ATE
	320 i	125		03.07	02.10			BAV1043		1				Warnkontakt L=1096mm	
	325 i	160		03.07	02.10										
	318 i	105		03.10				BA2309						23926 17,3 +/WE	ATE
	320 d	130		03.10											
	320 i	125		03.10											
	325 i	160		03.10											
	325 d	145		09.07	02.10			BAV1043		1				Warnkontakt L=1096mm	
	330 d	170		03.07	02.10										
	330 i	200		03.07	02.10										
	335 i	225		03.07	02.10										
	M3	309		03.08	02.10			BAV1043		1				Warnkontakt L=1096mm	
<b>BMW 5er Reihe/E34 (88-96)</b>															
	518 i			04.89	09.95			BA2125						20968 20,3 +/WE	ATE
	518 i Touring			03.93	11.96			BAV1003		1				Warnkontakt L=230mm	
	520 i	95		01.88	09.90										
	520 i 24V	110		03.89	09.95										
	520 i Touring	110		11.91	11.96										
	524 td	85		03.88	08.91										
	525 i	125		01.88	09.90										
	525 i 24V	141		09.89	09.95										
	525 i Touring	141		11.91	11.96										
	525 td	85		04.93	09.95										
	525 td Touring	85		03.93	11.96										
	525 tds	105		09.91	09.95										

<sup>1)</sup> + engine code N53 / + codice motore N53 / + moteur code N53 / + motor code N53

<sup>2)</sup> + engine code N52N / + codice motore N52N / + moteur code N52N / + motor code N52N



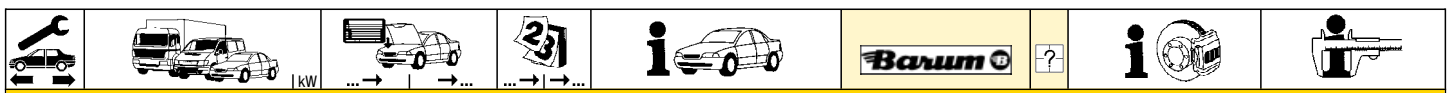

### BMW 5er Reihe/E34 (88-96)













	525 tds Touring	105	12.91	11.96	BA2125 BAV1003	1	20968 20,3 +/WE Warnkontakt L=230mm	ATE	
	530 i	138	01.88	09.95					
	530 i V8	160	03.92	09.95					
	530 i V8 Touring	160	05.92	11.96					
	535 i	155	01.88	09.95					
	540 i Touring	210	05.93	11.96					
	540 i V8	210	03.92	09.95					
	M5 3.6	232	10.88	09.95					
	M5 3.8	250	03.92	05.94					
	525 ix	141	04.91	09.95					BA2125
525 ix Touring	141	02.92	11.96						
M5 3.8	250	03.92	09.95	BAV1003					
M5 Touring	250	09.94	11.96						
	518 i		04.89	09.95	BAR12124		302 12,0 10,4 L		
	518 i Touring		03.93	11.96					
	520 i	95	01.88	09.90					- Behörde 1)
	520 i 24V	110	03.89	09.95					- Behörde 1)
	524 td	85	03.88	08.91					
	525 td	85	04.93	09.95					
	525 tds	105	09.91	09.95					
	520 i	95	01.88	09.90					+ Behörde 2)
	520 i 24V	110	03.89	09.95					+ Behörde 2)
	520 i Touring	110	11.91	11.96					
	525 i	125	01.88	09.90					
	525 i 24V	141	09.89	09.95					
	525 i Touring	141	11.91	11.96					
	525 td Touring	85	03.93	11.96					
	525 tds Touring	105	12.91	11.96					
530 i	138	01.88	09.95						
530 i V8	160	03.92	09.95						
530 i V8 Touring	160	05.92	11.96						
535 i	155	01.88	09.95						
540 i Touring	210	05.93	11.96	BAR28101		302 28,0 26,4 V L			
540 i V8	210	03.92	09.95						
	518 i		04.89	09.95	BA2054 BAV1003	1	20995 17,3 +/WE Warnkontakt L=230mm	ATE	
	518 i Touring		03.93	11.96					+ ABS
	520 i	95	01.88	09.90					
	520 i 24V	110	03.89	09.95					
	520 i Touring	110	11.91	11.96					
	524 td	85	03.88	08.91					
	525 i	125	01.88	09.90					
	525 i 24V	141	09.89	09.95					
	525 i Touring	141	11.91	11.96					
	525 ix	141	04.91	09.95					
	525 ix Touring	141	02.92	11.96					
	525 td	85	04.93	09.95					
	525 td Touring	85	03.93	11.96					
	525 tds	105	09.91	09.95					
	525 tds Touring	105	12.91	11.96					
	530 i	138	01.88	09.95					
	530 i V8	160	03.92	09.95					
	530 i V8 Touring	160	05.92	11.96					
	535 i	155	01.88	09.95					
	540 i Touring	210	05.93	11.96					
	540 i V8	210	03.92	09.95					
	M5 3.6	232	10.88	09.95					
	M5 3.8	250	03.92	05.94					
M5 3.8	250	06.94	09.95	BAV1003	1	Warnkontakt L=230mm			
M5 Touring	250	09.94	11.96						

### BMW 5er Reihe/E39 (96-03)

	520 d	100	04.00	07.03	BA2169 BAV1009	1	21677 19,5 +/WE Warnkontakt L=830mm	ATE				
	520 d Touring	100	04.00	07.03					- Behörde 1)			
	520 i		03.96	07.03					- Behörde 1)			
	520 i Touring		05.97	07.03					- Behörde 1)			
	523 i	125	12.95	09.00								
	523 i Touring	125	05.97	09.00								
	525 d	120	04.00	07.03					- Behörde 1)			
	525 d Touring	120	04.00	07.03					- Behörde 1)			
	525 i	141	10.00	07.03					- Behörde 1)			
	525 i Touring	141	10.00	07.03					- Behörde 1)			
	525 td	85	01.97	09.00								
	525 tds	105	02.96	09.00								
	525 tds Touring	105	06.98	09.00								
	528 i	142	12.95	09.00								
	528 i Touring	142	05.97	09.00								
	530 d		09.98	09.00								
	530 d Touring		09.98	09.00								
	535 i		05.96	08.97					BA2169 BAV1009	1	21677 19,5 +/WE Warnkontakt L=830mm	ATE
	520 d	100	04.00	07.03					+ Behörde 2)			
	520 d Touring	100	04.00	07.03					+ Behörde 2)	1	21486 19,3 +/WE Warnkontakt L=830mm	ATE
520 i		03.96	07.03	+ Behörde 2)								
520 i Touring		05.97	07.03	+ Behörde 2)								
525 d	120	04.00	07.03	+ Behörde 2)								
525 d Touring	120	04.00	07.03	+ Behörde 2)								

1) - authority cars / - enti statali / - véhicule communal / - vehiculos oficiales

2) + authority cars / + enti statali / + véhicule communal / + vehiculos oficiales

	   kW	 ... → ...	 ... → ...											
<b>BMW 5er Reihe/E39 (96-03)</b>														
	525 i	141		10.00	07.03	+ Behörde <sup>1)</sup>	BA2166	1	21486 19,3 +/WE Warnkontakt L=830mm	ATE				
	525 i Touring	141		10.00	07.03	+ Behörde <sup>1)</sup>	BAV1009							
	530 d			10.00	07.03									
	530 d Touring			10.00	07.03									
	530 i	170		10.00	07.03									
	530 i Touring	170		10.00	07.03									
	540 i	210		05.96	07.03									
	540 i Touring	210		05.97	07.03									
	535 i			09.97	07.03		BA2166 BAV1009							
	M5	294		10.98	07.03	- (USA)	BA2166 BAV1009				1	21486 19,3 +/WE Warnkontakt L=830mm	ATE	
	520 d	100		04.00	07.03	- Behörde <sup>2)</sup>	BAR22159	1	296 22,0 28,4 V L					
	520 d Touring	100		04.00	07.03	- Behörde <sup>2)</sup>								
	520 i			03.96	07.03	- Behörde <sup>2)</sup>								
	520 i Touring			05.97	07.03	- Behörde <sup>2)</sup>								
	523 i	125		12.95	09.00									
	523 i Touring	125		05.97	09.00									
	525 d	120		04.00	07.03	- Behörde <sup>2)</sup>								
	525 d Touring	120		04.00	07.03	- Behörde <sup>2)</sup>								
	525 i	141		10.00	07.03	- Behörde <sup>2)</sup>								
	525 i Touring	141		10.00	07.03	- Behörde <sup>2)</sup>								
	525 td	85		01.97	09.00									
	525 tds	105		02.96	09.00									
	525 tds Touring	105		06.98	09.00									
	528 i	142		12.95	09.00									
	528 i Touring	142		05.97	09.00									
	530 d			09.98	09.00									
	530 d Touring			09.98	09.00									
	535 i			05.96	08.97									
	535 i			09.97	02.00						BAR30101		324 30,0 28,4 V L	
	540 i	210		05.96	02.00									
	540 i Touring	210		05.97	02.00									
	520 d	100		04.00	07.03	+ Behörde <sup>1)</sup>					BAR30107	1	324 30,0 28,4 V L	
	520 d Touring	100		04.00	07.03	+ Behörde <sup>1)</sup>								
	520 i			03.96	07.03	+ Behörde <sup>1)</sup>								
	520 i Touring			05.97	07.03	+ Behörde <sup>1)</sup>								
525 d	120		04.00	07.03	+ Behörde <sup>1)</sup>									
525 d Touring	120		04.00	07.03	+ Behörde <sup>1)</sup>									
525 i	141		10.00	07.03	+ Behörde <sup>1)</sup>									
525 i Touring	141		10.00	07.03	+ Behörde <sup>1)</sup>									
530 d			10.00	07.03										
530 d Touring			10.00	07.03										
530 i	170		10.00	07.03										
530 i Touring	170		10.00	07.03										
535 i			03.00	07.03										
540 i	210		03.00	07.03										
540 i Touring	210		03.00	07.03										
	520 d	100		04.00	07.03		BA2170 BAV1010	1	21691 17,3 +/WE Warnkontakt L=550mm	ATE				
	520 i			03.96	07.03									
	523 i	125		12.95	09.00									
	525 d	120		04.00	07.03									
	525 i	141		10.00	07.03									
	525 td	85		01.97	09.00									
	525 tds	105		02.96	09.00									
	528 i	142		12.95	09.00									
	530 d			09.98	07.03									
	530 i	170		10.00	07.03									
	535 i			05.96	07.03									
	540 i	210		05.96	07.03									
	520 d Touring	100		04.00	07.03						BA2170 BAV1015	1	21691 17,3 +/WE Warnkontakt L=1100mm	ATE
	520 i Touring			05.97	07.03									
	523 i Touring	125		05.97	09.00									
	525 d Touring	120		04.00	07.03									
	525 i Touring	141		10.00	07.03									
	525 tds Touring	105		06.98	09.00									
	528 i Touring	142		05.97	09.00									
530 d Touring			09.98	07.03										
530 i Touring	170		10.00	07.03										
540 i Touring	210		05.97	07.03										
M5	294		10.98	07.03		BA2167		21487 17,3 +/WE	ATE					
	520 d	100		04.00	07.03	- Behörde <sup>2)</sup>	BAR10227	1	298 10,0 8,4 L					
	520 i			03.96	07.03	- Behörde <sup>2)</sup>								
	523 i	125		12.95	08.98	- Behörde <sup>2)</sup>								
	525 td	85		01.97	09.00	- Behörde <sup>2)</sup>								
	525 tds	105		02.96	09.00	- Behörde <sup>2)</sup>								
	520 d	100		04.00	07.03	+ Behörde <sup>1)</sup>					BAR20154	1	298 20,0 18,4 V L	
	520 d Touring	100		04.00	07.03	+ Behörde <sup>1)</sup>								
	520 i			03.96	07.03	+ Behörde <sup>1)</sup>								
	520 i Touring			05.97	07.03	+ Behörde <sup>1)</sup>								
	523 i	125		12.95	08.98	+ Behörde <sup>1)</sup>								
523 i	125		09.98	09.00										
523 i Touring	125		05.97	09.00										
525 d	120		04.00	07.03										
525 d Touring	120		04.00	07.03										
525 i	141		10.00	07.03										

<sup>1)</sup> + authority cars / + enti statali / + véhicule communal / + vehiculos oficiales

<sup>2)</sup> - authority cars / - enti statali / - véhicule communal / - vehiculos oficiales

**BMW 5er Reihe/E39 (96-03)**

	525 i Touring	141	10.00	07.03		BAR20154			298 20,0 18,4 V L
	525 td	85	01.97	09.00	+ Behörde <sup>1)</sup>				
	525 tds	105	02.96	09.00	+ Behörde <sup>1)</sup>				
	525 tds Touring	105	06.98	09.00					
	528 i	142	12.95	09.00					
	528 i Touring	142	05.97	09.00					
	530 d		09.98	07.03					
	530 d Touring		09.98	07.03					
	530 i	170	10.00	07.03					
	530 i Touring	170	10.00	07.03					
	535 i		05.96	07.03					
	540 i	210	05.96	07.03					
	540 i Touring	210	05.97	07.03					
	520 d	100	04.00	07.03		BAH0025	2	am Bremsattel <sup>2)</sup>	L=280
	520 i		03.96	07.03					
	520 i Touring		05.97	07.03					
	523 i	125	12.95	09.00					
	523 i Touring	125	05.97	09.00					
	525 d	120	04.00	07.03					
	525 i	141	10.00	07.03					
	525 td	85	01.97	09.00					
	525 tds	105	02.96	09.00					
	525 tds Touring	105	06.98	09.00					
	528 i	142	12.95	09.00					
	528 i Touring	142	05.97	09.00					
	530 d		09.98	07.03					
	530 i	170	10.00	07.03					
	535 i		05.96	07.03					
	540 i	210	05.96	07.03					
	M5	294	10.98	07.03					

**BMW 5er Reihe/E60 Limousine (03-10)**

	520 d		07.05	02.10	- Behörde <sup>3)</sup>	BA2252	1		23794 19,6 +/WE ATE
	520 i	125	07.03	03.05	+ Schaltgetriebe <sup>4)</sup>	BAV1025			Warnkontakt L=672mm
	523 i	130	07.05	03.07	- Behörde <sup>3)</sup>				
	523 i	140	03.07	02.10	- Behörde/ + Motorcode N52N <sup>5)</sup>				
	525 d		10.03	03.07	- Behörde <sup>3)</sup>				
	525 i	141	07.03	06.05	- Behörde <sup>3)</sup>				
	525 i	160	03.07	02.10	- Behörde/ + Motorcode N52N <sup>5)</sup>				
	520 d		07.05	02.10	+ Behörde <sup>1)</sup>	BA2245	1		23312 19,6 +/WE ATE
	520 d	130	09.07	02.10		BAV1025			Warnkontakt L=672mm
	520 i	125	07.03	03.05	+ Automatikgetriebe <sup>6)</sup>				
	523 i	130	07.05	03.07	+ Behörde <sup>1)</sup>				
	523 i	140	03.07	02.10	+ Behörde/ + Motorcode N52N <sup>7)</sup>				
	523 i	140	03.07	02.10	+ Motorcode N53 <sup>8)</sup>				
	525 d		10.03	03.07	+ Behörde <sup>1)</sup>				
	525 d	145	03.07	02.10					
	525 i	141	07.03	06.05	+ Behörde <sup>1)</sup>				
	525 i	160	07.05	03.07					
	525 i	160	03.07	02.10	+ Behörde/ + Motorcode N52N <sup>7)</sup>				
	525 i	160	03.07	02.10	+ Motorcode N53 <sup>8)</sup>				
	525 xd	145	03.07	02.10					
	525 xi	160	07.05	02.10					
	530 d	160	07.03	08.05					
	530 d	170	07.03	03.07					
	530 d	173	03.07	02.10					
	530 i	170	07.03	03.05					
	530 i	190	07.05	03.07					
	530 i	200	01.07	02.10					
	530 xd	170	07.05	03.07					
	530 xd	173	03.07	02.10					
	530 xi	190	07.05	03.07					
	530 xi	200	03.07	02.10					
	530 d	160	07.03	08.05		BA2245	1		23312 19,6 +/WE ATE
	530 d	170	07.03	03.07		BAV1025			Warnkontakt L=672mm
	530 d	173	03.07	02.10					
	530 i	170	07.03	03.05					
	530 i	190	07.05	03.07					
	530 i	200	01.07	02.10					
	530 xd	170	07.05	03.07					
	530 xd	173	03.07	02.10					
	530 xi	190	07.05	03.07					
	530 xi	200	03.07	02.10					
	540 i	225	07.05	03.07		BA2245	1		23312 19,6 +/WE ATE
	540 i	225	03.07	02.10	- erhöhte Zuladung <sup>9)</sup>	BAV1025			Warnkontakt L=672mm
	545 i	245	07.03	08.05					
	550 i	270	03.07	02.10	+ (USA)				
	535 d	200	09.04	03.07		BAV1025	1		Warnkontakt L=672mm
	535 d	210	03.07	02.10					
	540 i	225	03.07	02.10	+ erhöhte Zuladung <sup>10)</sup>				
	550 i	270	07.05	03.07		BAV1025	1		Warnkontakt L=672mm
	550 i	270	03.07	02.10	- (USA)				
	M5	373	09.04	02.10					

<sup>1)</sup> + authority cars / + enti statali / + véhicule communal / + vehiculos oficiales  
<sup>2)</sup> on the brake caliper / sulla pinza freno / sur l'étrier de frein / a la pinza de freno  
<sup>3)</sup> - authority cars / - enti statali / - véhicule communal / - vehiculos oficiales  
<sup>4)</sup> + manual transmission / + scatola cambio velocità / + transmission mécanique / + cambio de velocidad  
<sup>5)</sup> - authority cars/+engine co. N52N / - enti statali/+codice mot.N52N / - véhicule communal/+moteur co.N52N / - vehiculos oficiales/+motor co.N52N  
<sup>6)</sup> + autom.transmission / + scatola cambio automatico / + transmission automatique / + cambio automatico  
<sup>7)</sup> + authority cars/+engine no.N52N / + enti statali/+codice mot.N52N / + véhicule communal/+moteur co.N52N / + vehiculos oficiales/+motor co.N52N  
<sup>8)</sup> + engine code N53 / + codice motore N53 / + moteur code N53 / + motor code N53  
<sup>9)</sup> - increased payload / - carico utile maggiorato / - charge utile augmentée / - incremento de carga  
<sup>10)</sup> + increased payload / + carico utile maggiorato / + charge utile augmentée / + incremento de carga

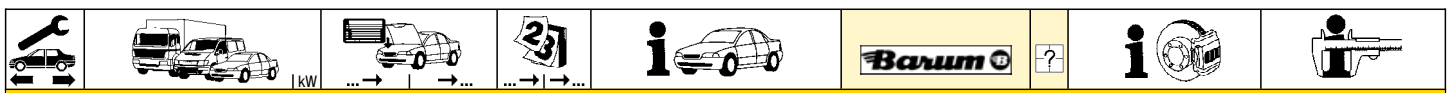

**BMW 5er Reihe/E60 Limousine (03-10)**

	520 d		07.05	02.10	- Behörde <sup>1)</sup>	BAR24181		310 24,0 22,4 V L
	520 i	125	07.03	03.05	+ Schaltgetriebe <sup>2)</sup>			
	523 i	130	07.05	03.07	- Behörde <sup>1)</sup>			
	523 i	140	03.07	02.10	- Behörde/ + Motorcode N52N <sup>3)</sup>			
	525 d		10.03	03.07	- Behörde <sup>1)</sup>			
	525 i	141	07.03	06.05	- Behörde <sup>1)</sup>			
	525 i	160	03.07	02.10	- Behörde/ + Motorcode N52N <sup>3)</sup>			
	520 d		07.05	02.10	+ Behörde <sup>4)</sup>	BAR30173		324 30,0 28,4 V L
	520 d	130	09.07	02.10				
	520 i	125	07.03	03.05	+ Automatikgetriebe <sup>5)</sup>			
	523 i	130	07.05	03.07	+ Behörde <sup>4)</sup>			
	523 i	140	03.07	02.10	+ Behörde/ + Motorcode N52N <sup>6)</sup>			
	523 i	140	03.07	02.10	+ Motorcode N53 <sup>7)</sup>			
	525 d		10.03	03.07	+ Behörde <sup>4)</sup>			
	525 d	145	03.07	02.10	- Behörde <sup>1)</sup>			
	525 i	141	07.03	06.05	+ Behörde <sup>4)</sup>			
	525 i	160	07.05	03.07				
	525 i	160	03.07	02.10	+ Behörde/ + Motorcode N52N <sup>6)</sup>			
	525 i	160	03.07	02.10	- Behörde/ + Motorcode N53 <sup>8)</sup>			
	525 xd	145	03.07	02.10				
	525 xi	160	07.05	02.10				
	530 d	160	07.03	08.05	- Behörde <sup>1)</sup>			
	530 d	170	07.03	03.07	- Behörde <sup>1)</sup>			
	530 d	173	03.07	02.10	- Behörde <sup>1)</sup>			
	530 i	170	07.03	03.05				
	530 i	190	07.05	03.07	- Behörde <sup>1)</sup>			
	530 i	200	01.07	02.10	- Behörde/ + Motorcode N52N <sup>3)</sup>			
	530 xd	170	07.05	03.07				
	530 xd	173	03.07	02.10				
	530 xi	190	07.05	03.07				
530 xi	200	03.07	02.10					
	520 d		07.05	02.10		BA2240 BAV1040	1	23732 17,3 +/-WE ATE Warnkontakt L=678mm
	520 d	130	09.07	02.10				
	520 i	125	07.03	03.05				
	523 i	130	07.05	03.07				
	523 i	140	03.07	02.10				
	525 d		10.03	03.07				
	525 d	145	03.07	02.10	- Behörde <sup>1)</sup>			
	525 i	141	07.03	06.05				
	525 i	160	07.05	03.07				
	525 i	160	03.07	02.10	+ Motorcode N52N <sup>9)</sup>			
	525 i	160	03.07	02.10	- Behörde/ + Motorcode N53 <sup>8)</sup>			
	525 xd	145	03.07	02.10				
	525 xi	160	07.05	02.10				
	530 d	160	07.03	08.05	- Behörde <sup>1)</sup>			
	530 d	170	07.03	03.07	- Behörde <sup>1)</sup>			
	530 d	173	03.07	02.10	- Behörde <sup>1)</sup>			
	530 i	170	07.03	03.05				
	530 i	190	07.05	03.07	- Behörde <sup>1)</sup>			
	530 i	200	01.07	02.10	- Behörde/ + Motorcode N52N <sup>3)</sup>			
	530 xd	170	07.05	03.07				
	530 xd	173	03.07	02.10				
	530 xi	190	07.05	03.07				
	530 xi	200	03.07	02.10				
	525 d	145	03.07	02.10	+ Behörde <sup>4)</sup>	BAV1040	1	Warnkontakt L=678mm
	525 i	160	03.07	02.10	+ Behörde/ + Motorcode N53 <sup>10)</sup>			
	530 d	160	07.03	08.05	+ Behörde <sup>4)</sup>			
	530 d	170	07.03	03.07	+ Behörde <sup>4)</sup>			
	530 d	173	03.07	02.10	+ Behörde <sup>4)</sup>			
	530 i	190	07.05	03.07	+ Behörde <sup>4)</sup>			
	530 i	200	01.07	02.10	+ Behörde/ + Motorcode N52N <sup>6)</sup>			
	530 i	200	01.07	02.10	+ Motorcode N53 <sup>7)</sup>			
	535 d	200	09.04	03.07				
	535 d	210	03.07	02.10				
	540 i	225	07.05	02.10				
	545 i	245	07.03	08.05				
	550 i	270	07.05	02.10				
M5	373	09.04	02.10					
	520 d		07.05	02.10		BAR20183		320 20,0 18,4 V L
	520 d	130	09.07	02.10				
	520 i	125	07.03	03.05				
	523 i	130	07.05	03.07				
	523 i	140	03.07	02.10				
	525 d		10.03	03.07				
	525 d	145	03.07	02.10	- Behörde <sup>1)</sup>			
	525 i	141	07.03	06.05				
	525 i	160	07.05	03.07				
	525 i	160	03.07	02.10	+ Motorcode N52N <sup>9)</sup>			
	525 i	160	03.07	02.10	- Behörde/ + Motorcode N53 <sup>8)</sup>			
	530 d	160	07.03	08.05	- Behörde <sup>1)</sup>			
	530 d	170	07.03	03.07	- Behörde <sup>1)</sup>			
530 d	173	03.07	02.10	- Behörde <sup>1)</sup>				
530 i	170	07.03	03.05					
530 i	190	07.05	03.07	- Behörde <sup>1)</sup>				
530 i	200	01.07	02.10	- Behörde/ + Motorcode N52N <sup>3)</sup>				

<sup>1)</sup> - authority cars / - enti statali / - véhicule communal / - vehiculos oficiales

<sup>2)</sup> + manual transmission / + scatola cambio velocità / + transmission mécanique / + cambio de velocidad

<sup>3)</sup> - authority cars/+engine co. N52N / - enti statali/+codice mot.N52N / - véhicule communal/+moteur co.N52N / - vehiculos oficiales/+motor co.N52N

<sup>4)</sup> + authority cars / + enti statali / + véhicule communal / + vehiculos oficiales

<sup>5)</sup> + autom.transmission / + scatola cambio automatico / + transmission automatique / + cambio automatico

<sup>6)</sup> + authority cars/+engine no.N52N / + enti statali/+codice mot.N52N / + véhicule communal/+moteur co.N52N / + vehiculos oficiales/+motor co.N52N

<sup>7)</sup> + engine code N53 / + codice motore N53 / + moteur code N53 / + motor code N53

<sup>8)</sup> - authority cars/+engine co.N53 / - enti statali/+codice mot.N53 / - véhicule communal/+moteur co.N53 / - vehiculos oficiales/+motor co.N53

<sup>9)</sup> + engine code N52N / + codice motore N52N / + moteur code N52N / + motor code N52N

<sup>10)</sup> + authority cars/+engine no.N53 / + enti statali/+codice mot.N53 / + véhicule communal/+moteur co.N53 / + vehiculos oficiales/+motor co.N53

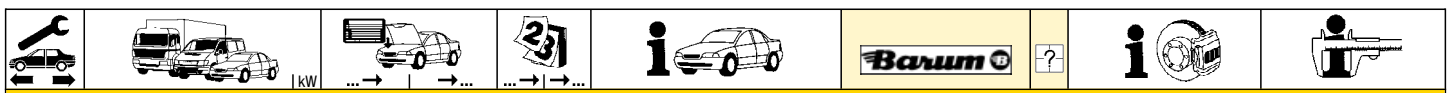

**BMW 5er Reihe/E61 Touring (04-10)**

	520 d	120	07.05	05.10	- Behörde <sup>1)</sup>	BA2252 BAV1025	1		23794 19,6 +/WE Warnkontakt L=672mm	ATE					
	520 i	125	06.04	05.10	- Behörde <sup>1)</sup>										
	523 i	130	07.05	03.07	- Behörde <sup>1)</sup>										
	523 i	140	03.07	05.10	- Behörde/ + Motorcode N52N <sup>2)</sup>										
	525 d	120	12.04	05.10											
	525 d	130	05.04	03.07	- Behörde <sup>1)</sup>										
	525 i	141	05.04	03.05	- Behörde <sup>1)</sup>										
	525 i	160	03.07	05.10	- Behörde/ + Motorcode N52N <sup>2)</sup>										
	520 d	120	07.05	05.10	+ Behörde <sup>3)</sup>						BA2245 BAV1025	1		23312 19,6 +/WE Warnkontakt L=672mm	ATE
	520 d	130	09.07	05.10											
	520 i	125	06.04	05.10	+ Behörde <sup>3)</sup>										
	523 i	130	07.05	03.07	+ Behörde <sup>3)</sup>										
	523 i	140	03.07	05.10	+ Behörde/ + Motorcode N52N <sup>4)</sup>										
	523 i	140	03.07	05.10	+ Motorcode N53 <sup>5)</sup>										
	525 d	120	12.04	05.10											
525 d	130	05.04	03.07	+ Behörde <sup>3)</sup>											
525 d	145	03.07	05.10												
525 i	141	05.04	03.05	+ Behörde <sup>3)</sup>											
525 i	160	07.05	03.07												
525 i	160	03.07	05.10	+ Behörde/ + Motorcode N52N <sup>4)</sup>											
525 i	160	03.07	05.10	+ Motorcode N53 <sup>5)</sup>											
525 xd	145	03.07	05.10												
525 xi	160	07.05	05.10												
530 d	160	05.04	08.05												
530 d	170	07.05	03.07												
530 d	173	03.07	05.10												
530 i	190	07.05	03.07												
530 i	200	03.07	05.10												
530 xd	170	07.05	03.07												
530 xd	173	03.07	05.10												
530 xi	190	07.05	03.07												
530 xi	200	03.07	05.10												
545 i	245	05.04	08.05		BA2245 BAV1025	1		23312 19,6 +/WE Warnkontakt L=672mm	ATE						
550 i	270	03.07	05.10	+ USA											
535 d	200	09.04	03.07		BAV1025	1		Warnkontakt L=672mm							
535 d	210	03.07	05.10												
550 i	270	07.05	03.07		BAV1025	1		Warnkontakt L=672mm							
550 i	270	03.07	05.10	- USA											
M5	373	02.07	05.10		BAV1025	1		Warnkontakt L=672mm							
	520 d	110	09.05	05.10	- Behörde <sup>1)</sup>	BAR24181			310 24,0 22,4 V L						
	520 d	120	07.05	05.10	- Behörde <sup>1)</sup>										
	520 i	125	06.04	05.10	- Behörde <sup>1)</sup>										
	523 i	130	07.05	03.07	- Behörde <sup>1)</sup>										
	523 i	140	03.07	05.10	- Behörde/ + Motorcode N52N <sup>2)</sup>										
	525 d	120	12.04	05.10											
	525 d	130	05.04	03.07	- Behörde <sup>1)</sup>										
	525 i	141	05.04	03.05	- Behörde <sup>1)</sup>										
	525 i	160	03.07	05.10	- Behörde/ + Motorcode N52N <sup>2)</sup>										
	520 d	110	09.09	05.10	+ Behörde <sup>3)</sup>						BAR30173			324 30,0 28,4 V L	
	520 d	120	07.05	05.10	+ Behörde <sup>3)</sup>										
	520 d	130	09.07	05.10											
	520 i	125	06.04	05.10	+ Behörde <sup>3)</sup>										
	523 i	130	07.05	03.07	+ Behörde <sup>3)</sup>										
	523 i	140	03.07	05.10	+ Behörde/ + Motorcode N52N <sup>4)</sup>										
523 i	140	03.07	05.10	+ Motorcode N53 <sup>5)</sup>											
525 d	120	12.04	05.10												
525 d	130	05.04	03.07	+ Behörde <sup>3)</sup>											
525 d	145	03.07	05.10	- Behörde <sup>1)</sup>											
525 i	141	05.04	03.05	+ Behörde <sup>3)</sup>											
525 i	160	07.05	03.07												
525 i	160	03.07	05.10	+ Behörde/ + Motorcode N52N <sup>4)</sup>											
525 i	160	03.07	05.10	- Behörde/ + Motorcode N53 <sup>6)</sup>											
525 xd	145	03.07	05.10												
525 xi	160	07.05	05.10												
530 d	160	05.04	08.05	- Behörde <sup>1)</sup>											
530 d	170	07.05	03.07	- Behörde <sup>1)</sup>											
530 d	173	03.07	05.10	- Behörde <sup>1)</sup>											
530 i	190	07.05	03.07												
530 i	200	03.07	05.10	- Behörde/ + Motorcode N52N <sup>2)</sup>											
530 xd	170	07.05	03.07												
530 xd	173	03.07	05.10												
530 xi	190	07.05	03.07												
530 xi	200	03.07	05.10												
	520 d	120	07.05	05.10		BA2240 BAV1041	1		23732 17,3 +/WE Warnkontakt L=885mm	ATE					
	520 d	130	09.07	05.10											
	520 i	125	06.04	05.10											
	523 i	130	07.05	03.07											
	523 i	140	03.07	05.10											
	525 d	120	12.04	05.10											
	525 d	130	05.04	03.07											
	525 d	145	03.07	05.10	- Behörde <sup>1)</sup>										
	525 i	141	05.04	03.05											
	525 i	160	07.05	03.07											
	525 i	160	03.07	05.10	+ Motorcode N52N <sup>7)</sup>										
	525 i	160	03.07	05.10	- Behörde/ + Motorcode N53 <sup>6)</sup>										
	525 xd	145	03.07	05.10											

<sup>1)</sup> - authority cars / - enti statali / - véhicule communal / - vehiculos oficiales

<sup>2)</sup> - authority cars/+engine co.N52N / - enti statali/+codice mot.N52N / - véhicule communal/+moteur co.N52N / - vehiculos oficiales/+motor co.N52N

<sup>3)</sup> + authority cars / + enti statali / + véhicule communal / + vehiculos oficiales

<sup>4)</sup> + authority cars/+engine no.N52N / + enti statali/+codice mot.N52N / + véhicule communal/+moteur co.N52N / + vehiculos oficiales/+motor co.N52N

<sup>5)</sup> + engine code N53 / + codice motore N53 / + moteur code N53 / + motor code N53

<sup>6)</sup> - authority cars/+engine co.N53 / - enti statali/+codice mot.N53 / - véhicule communal/+moteur co.N53 / - vehiculos oficiales/+motor co.N53

<sup>7)</sup> + engine code N52N / + codice motore N52N / + moteur code N52N / + motor code N52N

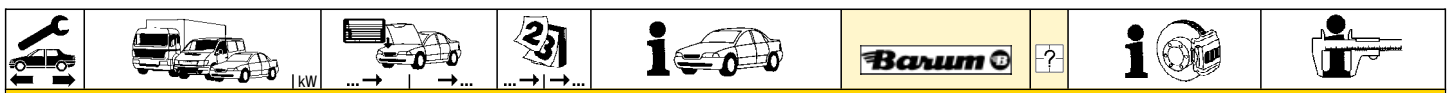

### BMW 5er Reihe/E61 Touring (04-10)

	525 xi	160	07.05	05.10	BA2240 BAV1041	1		23732 17,3 +/WE Warnkontakt L=885mm	ATE
	530 d	160	05.04	08.05					
	530 d	170	07.05	03.07 - Behörde 1)					
	530 d	173	03.07	05.10 - Behörde 1)					
	530 i	190	07.05	03.07					
	530 i	200	03.07	05.10 - Behörde/ + Motorcode N52N 2)					
	530 xd	170	07.05	03.07					
	530 xd	173	03.07	05.10					
	530 xi	190	07.05	03.07					
	530 xi	200	03.07	05.10					
	525 d	145	03.07	05.10 + Behörde 3)	BAV1041	1		Warnkontakt L=885mm	
	525 i	160	03.07	05.10 + Behörde/ + Motorcode N53 4)					
	530 d	170	07.05	03.07 + Behörde 3)					
	530 d	173	03.07	05.10 + Behörde 3)					
	530 i	200	03.07	05.10 + Behörde/ + Motorcode N52N 5)					
	530 i	200	03.07	05.10 + Motorcode N53 6)					
	535 d	200	09.04	03.07					
	535 d	210	03.07	05.10					
	545 i	245	05.04	08.05					
	550 i	270	07.05	05.10					
	520 d	120	07.05	05.10	BAR20183			320 20,0 18,4 V L	
	520 d	130	09.07	05.10					
	520 i	125	06.04	05.10					
	523 i	130	07.05	03.07					
	523 i	140	03.07	05.10					
	525 d	120	12.04	05.10					
	525 d	130	05.04	03.07					
	525 d	145	03.07	05.10 - Behörde 1)					
	525 i	141	05.04	03.05					
	525 i	160	07.05	03.07					
	525 i	160	03.07	05.10 + Motorcode N52N 7)					
	525 i	160	03.07	05.10 - Behörde/ + Motorcode N53 8)					
	530 d	160	05.04	08.05 - Behörde 1)					
	530 d	170	07.05	03.07 - Behörde 1)					
	530 d	173	03.07	05.10 - Behörde 1)					
	530 i	190	07.05	03.07					
530 i	200	03.07	05.10 - Behörde/ + Motorcode N52N 2)						

### BMW 6er Reihe/E63 Coupe (04-11)

	630 i	190	07.04	08.07	BA2245 BAV1025	1		23312 19,6 +/WE Warnkontakt L=672mm	ATE
	630 i	200	09.07	05.11					
	645 Ci	245	12.03	08.07	BA2245 BAV1025	1		23312 19,6 +/WE Warnkontakt L=672mm	ATE
	635 d	210	09.07	05.11					
	650 i	270	07.05	05.11	BAV1025	1		Warnkontakt L=672mm	
	M6	373	06.05	05.11	BAV1025	1	☐	Warnkontakt L=672mm	
	630 i	190	07.04	08.07	BAR30173			324 30,0 28,4 V L	
	630 i	190	07.04	08.07	BA2240 BAV1040	1		23732 17,3 +/WE Warnkontakt L=678mm	ATE
	630 i	200	09.07	05.11					
	635 d	210	09.07	05.11	BAV1040	1		Warnkontakt L=678mm	
	645 Ci	245	12.03	08.07					
	650 i	270	07.05	05.11					
	M6	373	06.05	05.11					
	630 i	190	07.04	08.07	BAR20183			320 20,0 18,4 V L	

### BMW 6er Reihe/E64 Cabrio (04-11)

	630 i	190	07.04	08.07	BA2245 BAV1025	1	☐	23312 19,6 +/WE Warnkontakt L=672mm	ATE
	630 i	200	09.07	02.11					
	645 Ci	245	04.04	08.07	BA2245 BAV1025	1	☐	23312 19,6 +/WE Warnkontakt L=672mm	ATE
	635 d	210	09.07	02.11					
	650 i	270	07.05	02.11	BAV1025	1		Warnkontakt L=672mm	
	M6	373	07.06	02.11	BAV1025	1	☐	Warnkontakt L=672mm	
	630 i	190	07.04	08.07	BAR30173			324 30,0 28,4 V L	
	630 i	190	07.04	08.07	BA2240 BAV1040	1		23732 17,3 +/WE Warnkontakt L=678mm	ATE
	630 i	200	09.07	02.11					
	635 d	210	09.07	02.11	BAV1040	1		Warnkontakt L=678mm	
	645 Ci	245	04.04	08.07					
	650 i	270	07.05	02.11					
	M6	373	07.06	02.11					
	630 i	190	07.04	08.07	BAR20183			320 20,0 18,4 V L	

1) - authority cars / - enti statali / - véhicule communal / - vehiculos oficiales

2) - authority cars/+engine co.N52N / - enti statali/+codice mot.N52N / - véhicule communal/+moteur co.N52N / - vehiculos oficiales/+motor co.N52N

3) + authority cars / + enti statali / + véhicule communal / + vehiculos oficiales

















4) + authority cars/+engine no.N53 / + enti statali/+codice mot.N53 / + véhicule communal/+moteur co.N53 / + vehiculos oficiales/+motor co.N53

5) + authority cars/+engine no.N52N / + enti statali/+codice mot.N52N / + véhicule communal/+moteur co.N52N / + vehiculos oficiales/+motor co.N52N

6) + engine code N53 / + codice motore N53 / + moteur code N53 / + motor code N53



















7) + engine code N52N / + codice motore N52N / + moteur code N52N / + motor code N52N

8) - authority cars/+engine co.N53 / - enti statali/+codice mot.N53 / - véhicule communal/+moteur co.N53 / - vehiculos oficiales/+motor co.N53

	   kW									
<b>BMW 7er Reihe/E32 (86-94)</b>										
	730 i 6			07.86	06.94	BA2125 BAV1003	1	20968 20,3 +/WE Warnkontakt L=230mm	ATE	
	730 i 8	160		03.91	06.94					
	730 iL 6			12.87	06.94					
	730 iL 8	160		06.92	06.94					
	735 i			09.86	09.92					
	735 iL			09.86	09.92					
	740 i	210		09.91	06.94					
	740 iL	210		10.91	06.94					
	750 i	220		07.87	12.89					
	750 i	220		01.90	06.94					- ⊕ / + Faustsättel <sup>1)</sup>
750 iL	220		11.86	12.89						
750 iL	220		01.90	06.94	- ⊕ / + Faustsättel <sup>1)</sup>					
750 i	220		01.90	06.94	+ ⊕ / + Festsättel <sup>2)</sup>	BAV1003	1	Warnkontakt L=230mm		
750 iL	220		01.90	06.94	+ ⊕ / + Festsättel <sup>2)</sup>					
	730 i 6			07.86	10.87	BAR28101		302 28,0 26,4 V L		
	730 iL 6			12.87	06.94					
	735 i			09.86	09.92					
	735 iL			09.86	09.92					
	740 i	210		09.91	06.94					
	740 iL	210		10.91	06.94					
	750 i	220		07.87	12.89					
	750 i	220		01.90	06.94					- ⊕ / + Faustsättel <sup>1)</sup>
	750 iL	220		11.86	12.89					
	750 iL	220		01.90	06.94					- ⊕ / + Faustsättel <sup>1)</sup>
730 i 6			11.87	06.94	BAR22103		302 22,0 20,4 V L			
730 i 8	160		03.91	06.94						
730 iL 8	160		06.92	06.94						
750 i	220		01.90	06.94	+ ⊕ / + Festsättel <sup>2)</sup>	BAR30101		324 30,0 28,4 V L		
750 iL	220		01.90	06.94	+ ⊕ / + Festsättel <sup>2)</sup>					
	730 i 6			07.86	06.94	BA2054 BAV1003	1	20995 17,3 +/WE Warnkontakt L=230mm	ATE	
	730 i 8	160		03.91	06.94					
	730 iL 6			12.87	06.94					
	730 iL 8	160		06.92	06.94					
	735 i			09.86	09.92					
	735 iL			09.86	09.92					
	740 i	210		09.91	06.94					
	740 iL	210		10.91	06.94					
	750 i	220		07.87	06.94					
	750 iL	220		11.86	06.94					
<b>BMW 7er Reihe/E38 (93-01)</b>										
	725 tds	105		05.96	11.01	BAV1036	1	Warnkontakt L=570mm		
	728 i	142		07.95	11.01					
	728 iL	142		01.96	11.01					
	730 d			09.98	11.01					
	730 i			07.93	11.01					
	730 iL			05.94	11.01					
	735 i	173		01.96	11.01					
	735 iL	173		01.96	11.01					
740 i	210		07.93	11.01	BA2166 BAV1036	1	21486 19,3 +/WE Warnkontakt L=570mm	ATE		
740 iL	210		05.94	11.01						
	740 i	210		07.93	11.01	BAR30101		324 30,0 28,4 V L		
	740 iL	210		05.94	11.01					
	725 tds	105		05.96	11.01	BA2167		21487 17,3 +/WE	ATE	
	728 i	142		07.95	11.01					
	728 iL	142		01.96	11.01					
	730 d			09.98	11.01					
	730 i			07.93	11.01					
	730 iL			05.94	11.01					
	735 i	173		01.96	11.01					
	735 iL	173		01.96	11.01					
	740 d	180		05.99	11.01					
	740 i	210		07.93	11.01					
	740 iL	210		05.94	11.01					
	750 i	240		11.93	11.01					
750 iL	240		01.94	11.01						
	725 tds	105		05.96	11.01	BAR12132		324 12,0 10,4 L		
	728 i	142		07.95	11.01					
	728 iL	142		01.96	11.01					
	730 d			09.98	11.01					
	730 i			07.93	11.01					
	730 iL			05.94	11.01					
	735 i	173		01.96	11.01					
	735 iL	173		01.96	11.01					
	740 i	210		07.93	11.01					
	740 iL	210		05.94	11.01					
<b>BMW 7er Reihe/E65/E66 (02-08)</b>										
	730 d			09.02	08.08	BA2245 BAV1022	1	23312 19,6 +/WE Warnkontakt L=830mm	ATE	
	730 i	170		03.03	08.08					
	730 i, Li	190		07.05	08.08					
	730 Ld	170		03.05	08.08					
	730 Li	170		03.03	08.08					
	730 Li	170		03.03	08.08					



















1) - ⊕ / + fist type calipers / - ⊕ / + pinze flottanti / - ⊕ / + étriers à griffe / - ⊕ / + pinza de puno

2) + ⊕ / + fixed calipers / + ⊕ / + pinze freno fissa / + ⊕ / + étriers fixes / + ⊕ / + pinza de tija

									
<b>BMW 7er Reihe/E65/E66 (02-08)</b>									
	735 i	200	11.01	08.08	BA2245	1		23312 19,6 +/WE Warnkontakt L=830mm	ATE
	735 Li	200	04.02	08.08	BAV1022				
	740 d	190	09.02	08.08					
	740 i, Li	225	03.05	08.08	BA2245				
	745 i	245	11.01	08.08	BAV1022				
	745 Li	245	04.02	08.08					
	750 i	270	03.05	08.08	- Europa <sup>1)</sup>				
	750 Li	270	03.05	08.08	- Europa <sup>1)</sup>				
	760 i	327	03.03	08.08	- Europa <sup>1)</sup>				
	760 Li	327	03.03	08.08	- Europa <sup>1)</sup>				
	745 d		03.05	08.08					
	750 i	270	03.05	08.08	+ Europa <sup>2)</sup>				
	750 Li	270	03.05	08.08	+ Europa <sup>2)</sup>				
	760 i	327	03.03	08.08	+ Europa <sup>2)</sup>				
760 Li	327	03.03	08.08	+ Europa <sup>2)</sup>					
	730 d		09.02	02.05	BAV1037	1		Warnkontakt L=845mm	
	730 i	170	03.03	08.08					
	730 i, Li	190	07.05	08.08					
	730 Li	170	03.03	08.08					
	735 i	200	11.01	08.08					
	735 Li	200	04.02	08.08					
	730 d		03.05	08.08	BAV1037				
	730 Ld	170	03.05	08.08					
	740 d	190	09.02	08.08					
	740 i, Li	225	03.05	08.08					
	745 d		03.05	08.08					
	745 i	245	11.01	08.08					
	745 Li	245	04.02	08.08					
	750 i	270	03.05	08.08					
750 Li	270	03.05	08.08						
760 i	327	03.03	08.08						
760 Li	327	03.03	08.08						
<b>BMW 8er Reihe/E31 (90-99)</b>									
	850 i. Ci	220	04.90	08.91	BAV1003	1		Warnkontakt L=230mm	
	840 i	210	02.93	02.94	BAR30101			324 30,0 28,4 V L	
	850 i. Ci	220	04.90	10.94					
	850 i. Ci	220	04.90	08.91	BAV1003	1		Warnkontakt L=230mm	
	840 Ci	210	01.96	08.99	BAR12132			324 12,0 10,4 L	
	840 i	210	02.93	02.96					
	850 Ci	240	09.94	12.99					
	850 i. Ci	220	04.90	10.94					
<b>BMW X1 (09-)</b>									
	xDrive 23d	150	10.09	02.10	BA2252			23794 19,6 +/WE	ATE
	xDrive 23d	150	03.10		BA2252			23794 19,6 +/WE	ATE
	xDrive 25i	160	03.10						
	sDrive 18d	105	10.09	02.10	BA2309			23926 17,3 +/WE	ATE
	sDrive 20d	130	10.09	02.10					
	xDrive 18d	105	10.09	02.10					
	xDrive 20d	130	10.09	02.10					
	xDrive 23d	150	10.09	02.10					
	sDrive 18d	105	03.10		BA2309			23926 17,3 +/WE	ATE
	sDrive 18i	105	03.10						
	sDrive 20d	130	03.10						
	sDrive 20d ed	120	09.11						
	sDrive 20i	135	09.11						
xDrive 18d	105	03.10							
xDrive 20d	130	03.10							
xDrive 20i	135	09.11							
xDrive 23d	150	03.10							
xDrive 25i	160	03.10							
<b>BMW X3 (03-10)</b>									
	1.8 d	105	09.08	08.10	BA2190			23183 20,3 +/WE	ATE
	2.0 d		09.07	08.10					
	2.0 d	110	08.04	08.10					
	2.0 i	110	07.05	08.10					
	2.5 i	141	03.04	08.06					
	2.5 si	160	09.06	08.10					
	3.0 d		01.04	08.10					
	3.0 d	150	10.03	08.06					
	3.0 i	170	10.03	08.06					
	3.0 si	200	09.06	08.10					
	3.0 sd	210	09.06	08.10	BA2166			21486 19,3 +/WE	ATE
		3.0 sd	210	09.06	08.10	BAR30109			332 30,0 28,4 V L

























<sup>1)</sup> - Europe / - Europa / - Europe / - Europa  
<sup>2)</sup> + Europe / + Europa / + Europe / + Europa



























										
<b>BMW X3 (03-10)</b>										
	1.8 d	105		09.08	08.10	BA2167			21487 17,3 +/WE	ATE
	2.0 d			09.07	08.10					
	2.0 d	110		08.04	08.10					
	2.0 i	110		07.05	08.10					
	2.5 i	141		03.04	08.06					
	2.5 si	160		09.06	08.10					
	3.0 d			01.04	08.10					
	3.0 d	150		10.03	08.06					
	3.0 i	170		10.03	08.06					
	3.0 sd	210		09.06	08.10					
	3.0 si	200		09.06	08.10					
<b>BMW X5 (00-07)</b>										
	3.0 d			10.03	12.06	BA2166			21486 19,3 +/WE	ATE
	3.0 d	135		05.01	09.03	BAV1018	1		Warnkontakt L=800mm	
	3.0 i	170		04.00	12.06	BA2166			21486 19,3 +/WE	ATE
	4.4 i	210		04.00	09.03	BAV1018	1		Warnkontakt L=800mm	
	4.4 i	235		10.03	12.06					
	4.4 i	235		10.03	12.06					
	4.6 iS	255		12.01	09.03					
	4.8 iS	265		03.04	12.06					
	3.0 d			10.03	12.06	BAR30109			332 30,0 28,4 V L	
	3.0 d	135		05.01	09.03					
	3.0 i	170		04.00	12.06					
	4.4 i	210		04.00	09.03					
	4.4 i	235		10.03	12.06					
	3.0 d			10.03	12.06	BA2167			21487 17,3 +/WE	ATE
	3.0 d	135		05.01	09.03	BAV1019	1		Warnkontakt L=715mm	
	3.0 i	170		04.00	12.06					
	4.4 i	210		04.00	09.03	BA2167			21487 17,3 +/WE	ATE
	4.4 i	235		10.03	12.06	BAV1019	1		Warnkontakt L=715mm	
	4.6 iS	255		12.01	09.03					
	4.8 iS	265		03.04	12.06					
<b>BMW Z3 (95-02)</b>										
	1.8	85		10.95	10.98	BA2108			21643 17,8 +/WE	ATE
	1.9			10.95	12.02	BAV1006	1		Warnkontakt L=790mm	
	2.0	110		04.99	08.00					
	2.2	125		10.00	12.02					
	2.8 Coupe	141		07.97	06.00					
	2.8 Roadster	141		05.97	06.00					
	3.0 Coupe	170		06.00	12.02					
	3.0 Roadster	170		06.00	12.02					
	M Coupe			02.98	12.02	BA2125			20968 20,3 +/WE	ATE
	M Roadster			03.97	12.02	BAV1031	1		Warnkontakt L=810mm	
	1.8	85		10.95	10.98	BAR12126			286 11,9 10,4	
	1.9			10.95	12.02					
	2.0	110		04.99	08.00	BAR22115			286 22,0 20,4 V L	
	2.2	125		10.00	12.02					
	2.8 Coupe	141		07.97	06.00					
	2.8 Roadster	141		05.97	06.00					
	3.0 Coupe	170		06.00	12.02	BAR22160			300 22,0 20,4 V L	
	3.0 Roadster	170		06.00	12.02					
	1.8	85		10.95	10.98	BAH0001	2		L=425	
	1.9			10.95	12.00					
	2.0	110		04.99	08.00					
	2.2	125		10.00	12.02					
	2.8 Coupe	141		07.97	06.00					
	2.8 Roadster	141		05.97	06.00					
	3.0 Coupe	170		06.00	12.02					
	3.0 Roadster	170		06.00	12.02					
	1.8	85		10.95	10.98	BA2053			20180 17,3 +/WE	ATE
	1.9			10.95	12.02	BAV1011	1		Warnkontakt L=840mm	
	2.0	110		04.99	08.00					
	2.2	125		10.00	12.02					
	2.8 Coupe	141		07.97	06.00					
	2.8 Roadster	141		05.97	06.00					
	3.0 Coupe	170		06.00	12.02					
	3.0 Roadster	170		06.00	12.02					
	M Coupe			02.98	12.02	BA2054			20995 17,3 +/WE	ATE
	M Roadster			03.97	12.02	BAV1011	1		Warnkontakt L=840mm	
	1.8	85		10.95	10.98	BAR10273			272 10,0 8,4 L	
	1.9			10.95	12.02					
	2.0	110		04.99	08.00					
	2.2	125		10.00	12.02					
	2.8 Coupe	141		07.97	06.00					
	2.8 Roadster	141		05.97	06.00					
	3.0 Coupe	170		06.00	12.02					
	3.0 Roadster	170		06.00	12.02					















1) - special vehicles / - veicoli speciali / - véhicules spécial / - vehículo especial

2) + special vehicles / + veicolo speciale / + véhicule spécial / + vehículo especial





	   kW														
<b>BMW Z4 Roadster/E85 (03-08)</b>															
	2.0 i	110	04.05	12.08	BA2108 BAV1012	1		21643 17,8 +/-WE ATE Warnkontakt L=596mm							
	2.2 i	125	10.03	12.08											
	2.5 i	130	01.06	12.08											
	2.5 i	141	12.02	12.08											
	2.5 si	160	01.06	12.08											
	3.0 i	170	12.02	12.08											
	2.0 i	110	04.05	12.08	BA2190 BAR22115			23183 20,3 +/-WE ATE 286 22,0 20,4 V L							
	2.2 i	125	10.03	12.08											
	2.5 i	130	01.06	12.08											
	2.5 i	141	12.02	12.08											
	2.5 si	160	01.06	12.08											
	3.0 i	170	12.02	12.08											
	2.0 i	110	04.05	12.08	BAH0017	2		L=410							
	2.2 i	125	10.03	12.08											
	2.5 i	130	01.06	12.08											
	2.5 i	141	12.02	12.08											
	2.5 si	160	01.06	12.08											
	3.0 i	170	12.02	12.08											
	2.0 i	110	04.05	12.08	BA2053			20180 17,3 +/-WE ATE							
	2.2 i	125	10.03	12.08											
	2.5 i	130	01.06	12.08											
	2.5 i	141	12.02	12.08											
	2.5 si	160	01.06	12.08											
	3.0 i	170	12.02	12.08											
	2.0 i	110	04.05	12.08	BA2167			21487 17,3 +/-WE ATE							
	2.2 i	125	10.03	12.08											
	2.5 i	130	01.06	12.08											
	2.5 i	141	12.02	12.08											
	2.5 si	160	01.06	12.08											
	3.0 i	170	12.02	12.08											
	3.0 si	195	03.06	09.08	BA2190			23183 20,3 +/-WE ATE							
		3.0 si	195	03.06					09.08	BAR25138		325 25,0 23,4 V L			
		3.0 si	195	03.06					09.08				BAH0017	2	L=410
		3.0 si	195	03.06					09.08						
		3.0 si	195	03.06					09.08						
		M 3.2	252	03.06					09.08						
	sDrive 23i	150	01.09	02.10	BA2252			23794 19,6 +/-WE ATE							
	sDrive 20i	135	09.11						BA2252		23794 19,6 +/-WE ATE				
	sDrive 23i	150	03.10												
	sDrive 28i	180	09.11												
	sDrive 30i	190	03.10												
	sDrive 30i	190	01.09	02.10											
<b>BMW Z4 Roadster/E89 (09-)</b>															
	4.9	294	06.00	08.03	BA2167 BAV1010	1		21487 17,3 +/-WE ATE Warnkontakt L=550mm							
	<b>BMW Z8 (00-03)</b>														
	<b>CHEVROLET AVEO (04-)</b>														
		1.2 i	53	03.06					05.08	BAR20115		Naben D=60 <sup>1)</sup>	236 20,0 17,0 V L		
		1.2 i	55	01.08											
		1.2 i 16V	62	04.08											
1.4 i 16V		69	03.06	05.08											
1.4 i 16V		74	01.08												
1.5 i		62	05.05	05.08											
1.6 i 16V	77	12.04	09.06												
<b>CHEVROLET KALOS (05-08)</b>															
	1.2 i	53	03.05	05.08	BAR20115		Naben D=60 <sup>1)</sup>	236 20,0 17,0 V L							
	1.4 i	61	03.05	05.08											
	1.4 i 16V	69	03.05	05.08											
<b>CHEVROLET LANOS (05-)</b>															
	1.4	55	11.05		BA2136			20547 16,8 +/-WE ATE							
	1.5	63	11.05												
	1.6 i 16V	78	11.05												
	1.4	55	11.05		BAR20115			236 20,0 17,0 V L							
	1.5	63	11.05												
	1.6 i 16V	78	11.05												
	1.4	55	11.05		BAR24115			256 24,0 21,0 V L							
	1.5	63	11.05												
	1.4	55	11.05		BAW1705			Rz 17,46 LUC							
	1.5	63	11.05												

<sup>1)</sup> hub diameter=60 / diametro mozzo=60 / diamètre du moyeu=60 / diámetro del buje=60



								
<b>CHEVROLET LANOS (05-)</b>								
	1.4 1.5 1.6 i 16V	55 63 78		11.05 11.05 11.05			BAE5011	200 x 46 HEB
<b>CHEVROLET MATIZ (05-)</b>								
	0.8 0.8 LPG 1.0 1.0 1.0 LPG	38 38 47 49 49		03.05 03.05 03.05 03.05 03.05			BA2123	23241 15,8
<b>CHEVROLET SPARK (05-)</b>								
	0.8 1.0 i 16V SX	37 46		05.05 05.05			BA2123	23241 15,8
<b>CHRYSLER CROSSFIRE Coupe (03-08)</b>								
	3.2 V6	160		07.03	01.08		BA2168	21670 20,3 +/WE ATE
	3.2 V6	160		07.03	01.08		BAR25110	288 25,0 22,4 V L
	3.2 V6	160		07.03	01.08		BAR28106	300 28,0 25,4 V L
	3.2 V6 3.2 SRT-6	160 246		07.03 09.04	01.08 08.06		BA2164 BA2163	21919 15,8 ATE 21305 15,5 /WE ATE
	3.2 V6	160		07.03	01.08		BAR09114	278 9,0 7,3
<b>CHRYSLER CROSSFIRE Cabrio (04-08)</b>								
	3.2 V6	160		05.04	01.08		BA2168	21670 20,3 +/WE ATE
	3.2 V6	160		05.04	01.08		BAR25110	288 25,0 22,4 V L
	3.2 V6	160		05.04	01.08		BAR28106	300 28,0 25,4 V L
	3.2 V6 3.2 SRT-6	160 246		05.04 09.04	01.08 08.06		BA2164 BA2163	21919 15,8 ATE 21305 15,5 /WE ATE
	3.2 V6	160		05.04	01.08		BAR09114	278 9,0 7,3
<b>CITROEN AX (86-98)</b>								
	10 10 10 E 11 11 13 Sport 14 14 14 14 D 14 GT	32 33 30 40 44 44 49 55 62	ORGA 05089 ORGA 05089 ORGA 05089 ORGA 05089 ORGA 05089 ORGA 05089 ORGA 05089 ORGA 05089 ORGA 05089	09.86 07.86 12.86 12.86 10.89 04.87 12.86 06.88 03.89 09.88 01.88			BA2096	21179 16,8 +/WK ATE
	10 10 10 11 14 14 D 14 GT	32 33 37 44 55 62	ORGA 05090 ORGA 05090 ORGA 05090 ORGA 05090 ORGA 05090 ORGA 05090	06.92 12.98 12.98 12.97 12.92			BA2097	21191 17,0 +/WK ATE
	14 14 D 15 D 14 GTI	55	ORGA 05278 ORGA 05278 ORGA 05278	12.96 12.97 08.94 12.96			BA2074	20905 18,0 +/WK BDX
	10 10 10 10 E 11 11 14 14 14 14 D 14 GTI	32 33 37 30 40 44 44 49 55	ORGA 05277 ORGA 05277	09.86 07.86 07.92 12.86 12.86 10.89 12.86 06.88 03.89 09.88 06.91 12.96	06.92 12.98 12.98 12.88 06.90 12.97 12.88 12.89		BAR08107	238 8,0 6,0
	10 10 10 10 E 11 11 13 Sport	32 33 37 30 40 44		09.86 07.86 07.92 12.86 12.86 10.89 04.87	06.92 12.98 12.98 12.88 06.90 12.97 12.88		BAW1909 BAW1910	RzR 19,05 BDX RzR 19,05 BDX





















										
<b>CITROEN AX (86-98)</b>										
	14 14 14 D 14 GT 15 D	44 49 62		12.86 06.88 09.88 01.88 08.94	12.88 12.89 12.97 12.92 12.97		BAW1909 BAW1910		RzR 19,05 RzR 19,05	<b>BDX</b> <b>BDX</b>
	14 14 GTI	55		03.89 06.91	12.96 12.96 - ABS		BAW1913 BAW1912		RzR 19,05 RzR 19,05	
	10 10 10 10 E 11 11 13 Sport 14 14 14 D 14 GT 15 D	32 33 37 30 40 44 44 49 62		09.86 07.86 07.92 12.86 12.86 10.89 04.87 12.86 06.88 09.88 01.88 08.94	06.92 12.98 12.98 12.88 06.90 12.97 12.88 12.88 12.89 12.97 12.92 12.97		BAE5014		164 x 32 AUT	
	14 14 GTI	55		03.89 06.91	12.96 12.96		BAE5020		180 x 32 AUT	<b>BDX</b>
<b>CITROEN BERLINGO (MF) Kombi (96-08)</b>										
	1.1 i 1.1 i 1.4 GNC 1.4 GNC 1.4 Hybrid 1.4 Hybrid 1.4 i 1.4 i 1.6 16V 1.8 D 1.8 i 1.9 D 1.9 D 2.0 HDi Electric	44 44 48 48 54 54 55 55 80 43 66 50 51 66 27	ORGA 09428 ORGA 09127 ORGA 09428 ORGA 09127 ORGA 09428 ORGA 09127 ORGA 09428 ORGA 09127 ORGA 09127 ORGA 09127 ORGA 09127 ORGA 09127 ORGA 09127 ORGA 09127	07.96 07.96 11.02 11.02 05.05 05.05 07.96 07.96 10.00 07.98 05.97 07.96 07.98 12.99 01.00			BA2021		23124 19,0 +WK/S	<b>LUC</b>
	1.1 i 1.1 i 1.4 Bivalent 1.4 GNC 1.4 GNC 1.4 Hybrid 1.4 Hybrid 1.4 i 1.4 i 1.6 16V 1.6 HDi 1.6 HDi 75 1.6 HDi 90 1.8 D 1.8 i 1.9 D 1.9 D 2.0 HDi	44 44 48 48 54 54 55 55 80 80 55 66 43 66 50 51 66	ORGA 09128 ORGA 09429 ORGA 09128 ORGA 09429 ORGA 09128 ORGA 09429 ORGA 09128 ORGA 09429 ORGA 09128 ORGA 09128 ORGA 09429 ORGA 09128 ORGA 09128 ORGA 09128 ORGA 09128 ORGA 09128	03.08 03.08 11.02 03.08 03.08 03.08 03.08 03.08 03.08 03.08 08.05 07.05 07.05 03.08 03.08 03.08 03.08 03.08 03.08	03.08 03.08 03.08 03.08 03.08 03.08 03.08 03.08 03.08 03.08 03.08 03.08 03.08 03.08 03.08 03.08 03.08		BA2214		23599 19,0 /S	<b>BOS</b>
	1.6 16V 1.6 HDi 1.6 HDi 90 2.0 HDi	80 80 66 66	ORGA 09128 ORGA 09128 ORGA 09128 ORGA 09128	08.05 07.05 07.05	03.08 + ESP 03.08 + ESP 03.08 + ESP 03.08 + ESP		BA2289		23708 18,4 /S	<b>BOS</b>
	1.1 i 1.4 GNC 1.4 Hybrid 1.4 i Electric	44 48 54 55 27	ORGA 09428 ORGA 09428 ORGA 09428 ORGA 09428	07.96 11.02 05.05 07.96 01.00	03.08		BAR13184		266 13,0 11,0	
	1.1 i 1.4 GNC 1.4 Hybrid 1.4 i 1.6 16V 1.8 D 1.8 i 1.9 D 1.9 D 2.0 HDi	44 48 54 55 80 43 66 50 51 66	ORGA 09127 ORGA 09127 ORGA 09127 ORGA 09127 ORGA 09127 ORGA 09127 ORGA 09127 ORGA 09127 ORGA 09127 ORGA 09127	07.96 11.02 05.05 07.96 10.00 07.98 05.97 07.96 07.98 12.99			BAR20133		266 20,5 18,5 V	
	1.1 i 1.1 i 1.4 Bivalent 1.4 GNC 1.4 GNC 1.4 Hybrid 1.4 Hybrid 1.4 i 1.4 i 1.6 16V 1.6 HDi	44 44 48 48 54 54 55 55 80 80	ORGA 09128 ORGA 09429 ORGA 09128 ORGA 09429 ORGA 09128 ORGA 09429 ORGA 09128 ORGA 09429 ORGA 09128 ORGA 09128	03.08 03.08 11.02 03.08 03.08 03.08 03.08 03.08 03.08 08.05	03.08 03.08 03.08 03.08 03.08 03.08 03.08 03.08 03.08 03.08		BAR22194		266 22,0 20,0 V	

### CITROEN BERLINGO (MF) Kombi (96-08)

	1.6 HDi 75	55		07.05	03.08	BAR22194		266 22,0 20,0 V				
	1.6 HDi 90	66		07.05	03.08 - ESP							
	1.8 D	43 ORGA 09128			03.08							
	1.8 i	66 ORGA 09128			03.08							
	1.9 D	50 ORGA 09128			03.08							
	1.9 D	51 ORGA 09128			03.08							
	2.0 HDi	66 ORGA 09128			03.08 - ESP							
	1.6 16V	80 ORGA 09128			03.08 + ESP	BAR26120		283 26,0 24,0 V				
	1.6 HDi	80		08.05	03.08 + ESP							
	1.6 HDi 90	66		07.05	03.08 + ESP							
	2.0 HDi	66 ORGA 09128			03.08 + ESP							
	1.6 16V	80		10.00	03.08 + ESP	BA2017		20961 17,2 /S LUC				
	1.6 HDi	80		08.05	03.08 + ESP							
	1.6 HDi 90	66		07.05	03.08 + ESP							
	2.0 HDi	66		12.99	03.08 + ESP							
	1.6 16V	80		10.00	03.08 + ESP	BAR09137		247 9,0 8,0				
	1.6 HDi	80		08.05	03.08 + ESP							
	1.6 HDi 90	66		07.05	03.08 + ESP							
	2.0 HDi	66		12.99	03.08 + ESP							
	1.1 i	44		07.96	03.08	BAW2205		Rz 22,20 LUC				
	1.4 Bivalent	48		11.02	03.08							
	1.4 GNC	48		11.02	03.08							
	1.4 Hybrid	54		05.05	03.08							
	1.4 i	55		07.96	03.08							
	1.6 16V	80		10.00	03.08 - ESP							
	1.6 HDi	80		08.05	03.08 - ESP							
	1.6 HDi 75	55		07.05	03.08							
	1.6 HDi 90	66		07.05	03.08 - ESP							
	1.8 D	43		07.98	03.08							
	1.8 i	66		05.97	03.08							
	1.9 D	50		07.96	03.08							
	1.9 D	51		07.98	03.08							
	2.0 HDi	66		12.99	03.08 - ESP							
	Electric	27		01.00	03.08							
		1.1 i	44		07.96				03.08	BAE5019		229 x 42 HEB LUC
		1.4 Bivalent	48		11.02				03.08			
1.4 GNC		48		11.02	03.08							
1.4 Hybrid		54		05.05	03.08							
1.4 i		55		07.96	03.08							
1.6 16V		80		10.00	03.08 - ESP							
1.6 HDi		80		08.05	03.08 - ESP							
1.6 HDi 75		55		07.05	03.08							
1.6 HDi 90		66		07.05	03.08 - ESP							
1.8 D		43		07.98	03.08							
1.8 i		66		05.97	03.08							
1.9 D		50		07.96	03.08							
1.9 D		51		07.98	03.08							
2.0 HDi		66		12.99	03.08 - ESP							
Electric		27		01.00	03.08							

### CITROEN BERLINGO (M\_) Kasten (96-08)

	1.1 i	44	ORGA 09428	07.96		BA2021		23124 19,0 +/-WK/S LUC						
	1.1 i	44	ORGA 09127	07.96										
	1.4 i	55	ORGA 09428	07.96										
	1.4 i	55	ORGA 09127	07.96										
	1.6 16V	80	ORGA 09127	10.00										
	1.8 D	43	ORGA 09127	07.96										
	1.9 D	51	ORGA 09127	07.96										
	2.0 HDi 90	66	ORGA 09127	12.99										
	1.1 i	44	ORGA 09128		03.08	BA2214		23599 19,0 /S BOS						
	1.1 i	44	ORGA 09429		03.08									
	1.4	48		11.02	03.08									
	1.4 Bivalent	55		11.02	03.08									
	1.4 i	55 ORGA 09128			03.08									
	1.4 i	55 ORGA 09429			03.08									
	1.6 16V	80 ORGA 09128			03.08									
	1.6 HDi 75	55		07.05	03.08									
	1.8 D	43 ORGA 09128			03.08									
	1.9 D	51 ORGA 09128			03.08									
	2.0 HDi 90	66 ORGA 09128			03.08									
	1.1 i	44	ORGA 09428	07.96		BAR13184		266 13,0 11,0						
	1.4 i	55	ORGA 09428	07.96										
	1.1 i	44	ORGA 09127	07.96					BAR20133		266 20,5 18,5 V			
	1.4 i	55	ORGA 09127	07.96										
	1.6 16V	80	ORGA 09127	10.00										
	1.8 D	43	ORGA 09127	07.96										
	1.9 D	51	ORGA 09127	07.96										
	2.0 HDi 90	66	ORGA 09127	12.99										
	1.1 i	44	ORGA 09128		03.08							BAR22194		266 22,0 20,0 V
	1.1 i	44	ORGA 09429		03.08									
	1.4	48		11.02	03.08									
1.4 Bivalent	55		11.02	03.08										
1.4 i	55 ORGA 09128			03.08										
1.4 i	55 ORGA 09429			03.08										
1.6 16V	80 ORGA 09128			03.08										
1.6 HDi 75	55		07.05	03.08										

								
<b>CITROEN BERLINGO (M_) Kasten (96-08)</b>								
	1.8 D 1.9 D 2.0 HDi 90	43 ORGA 09128 51 ORGA 09128 66 ORGA 09128		03.08 03.08 03.08	BAR22194			266 22,0 20,0 V
	2.0 HDi 90	66	12.99	03.08 + ESP	BA2017			20961 17,2 /S LUC
	2.0 HDi 90	66	12.99	03.08 + ESP	BAR09137			247 9,0 8,0
	1.1 i 1.4 1.4 Bivalent 1.4 i 1.6 16V 1.6 HDi 75 1.8 D 1.9 D 2.0 HDi 90	44 48 55 55 80 55 43 51 66	07.96 11.02 11.02 07.96 10.00 07.05 07.96 07.96 12.99	03.08 03.08 03.08 03.08 03.08 03.08 03.08 03.08 03.08 - ESP	BAW2205			Rz 22,20 LUC
	1.1 i 1.4 1.4 Bivalent 1.4 i 1.6 16V 1.6 HDi 75 1.8 D 1.9 D 2.0 HDi 90	44 48 55 55 80 55 43 51 66	07.96 11.02 11.02 07.96 10.00 07.05 07.96 07.96 12.99	03.08 03.08 03.08 03.08 03.08 03.08 03.08 03.08 03.08 - ESP	BAE5019			229 x 42 HEB LUC
<b>CITROEN BERLINGO (B9) (08-)</b>								
	1.4 i 1.6 HDi 110 1.6 HDi 110 1.6 HDi 75 1.6 HDi 90 1.6 HDi 90 1.6 i 16V 1.6 i 16V 1.6 VTi 120 1.6 VTi 95	55 80 82 55 66 68 66 80 88 72	04.08 04.08 07.10 04.08 04.08 07.10 04.08 04.08 11.09 07.10		BAR26120			283 26,0 24,0 V
<b>CITROEN C1 (05-)</b>								
	1.0 1.4 HDi	50 40	06.05 06.05	12.08	BA2296			23959 17,6 /S BOS
<b>CITROEN C2 (03-09)</b>								
	1.1 i 1.4 HDi 1.4 i 1.4 HDi 1.6 16V 1.6 VTS	44 50 54 50 ORGA 10801 80 ORGA 10801 90	09.03 09.03 09.03 01.05	12.09 12.09 12.09 12.09 + bel.Scheiben /+16"Rad <sup>2)</sup> 12.09 + 16" Rad <sup>3)</sup>	BA2282 BA2214		- belüftete Scheiben <sup>1)</sup>	23407 19,3 /S LUC 23599 19,0 /S BOS
	1.1 i 1.4 HDi 1.4 i 1.4 16V 1.4 HDi 1.4 i 1.6 16V 1.6 VTS	44 50 54 65 50 54 80 90	09.03 09.03 09.03 06.06 09.03 09.03 09.03 01.05	12.09 12.09 12.09 12.09 12.09 12.09 12.09 12.09	BAR13184 BAR22194			266 13,0 11,0 266 22,0 20,0 V
	1.4 16V 1.4 HDi 1.4 i 1.6 16V 1.6 VTS	65 50 54 80 90	06.06 09.03 09.03 09.03 01.05	12.09 12.09 12.09 12.09 12.09	BA2017			20961 17,2 /S LUC
	1.4 16V 1.4 HDi 1.4 i 1.6 16V 1.6 VTS	65 50 54 80 90	06.06 09.03 09.03 09.03 01.05	12.09 12.09 12.09 12.09 12.09	BAR09137			247 9,0 8,0
<b>CITROEN C3 (02-09)</b>								
	1.1 i 1.4 bivalent 1.4 HDi 1.4 i 1.6 16V 1.6 16V HDi 110 1.6 16V 1.6 16V HDi 110 1.4 16V 1.6 16V 1.6 16V HDi 110 1.6 16V HDi 90	44 54 50 54 80 80 ORGA 10800 80 ORGA 10800 80 ORGA 10801 65 80 80 66	02.02 09.05 02.02 02.02 02.02 09.05 02.02 08.09 12.03 02.02 09.05 10.05	08.09 08.09 08.09 08.09 + Automatikgetriebe <sup>4)</sup> + Automatikgetriebe <sup>4)</sup> 08.09 08.09 + Schaltgetriebe <sup>5)</sup> 08.09 08.09	BA2282 BA2289 BA2229 BA2214			23407 19,3 /S LUC 23708 18,4 /S BOS 23600 19,0 /S BOS 23599 19,0 /S BOS



















<sup>1)</sup> - ventilated discs / - dischi ventilati / - disques ventilés / - disco ventilado

<sup>2)</sup> + ventilated discs/+ 16 wheel / + dischi ventilati/+ ruota 16 / + disques ventilés/+ roue 16 / + disco ventilado/+ ruota 16



















<sup>3)</sup> + 16" wheel / + ruota 16" / + roue 16" / + ruota 16"

<sup>4)</sup> + autom.transmission / + scatola cambio automatico / + transmission automatique / + cambio automático

<sup>5)</sup> + manual transmission / + scatola cambio velocità / + transmission mécanique / + cambio de velocidad

								
<b>CITROEN C3 (02-09)</b>								
	1.1 i	44		02.02	08.09		BAR13184	266 13,0 11,0
	1.4 bivalent	54		09.05	08.09			
	1.4 HDi	50		02.02	08.09			
	1.4 i	54		02.02	08.09			
	1.4 16V	65		12.03	08.09		BAR22194	266 22,0 20,0 V
	1.4 16V HDi 90	66		02.02	08.09			
	1.6 16V	80		02.02	08.09	+ Schaltgetriebe <sup>1)</sup>		
	1.6 16V HDi 110	80		09.05	08.09			
	1.6 16V HDi 90	66		10.05	08.09			
1.6 16V HDi 110	80		09.05	08.09		BAR26120	283 26,0 24,0 V	
1.6 16V	80		02.02	08.09	+ Automatikgetriebe <sup>2)</sup>	BAR26120	283 26,0 24,0 V	
	1.6 16V	80		02.02	08.09		BA2017	20961 17,2 /S LUC
	1.6 16V HDi 110	80		09.05	08.09			
	1.6 16V HDi 90	66		10.05	08.09			
	1.6 16V	80		02.02	08.09		BAR09137	247 9,0 8,0
	1.6 16V HDi 110	80		09.05	08.09			
	1.6 16V HDi 90	66		10.05	08.09			
<b>CITROEN C3 Picasso (09-)</b>								
	1.4 VTi 95	70		02.09			BA2214	23599 19,0 /S BOS
	1.6 Flex	78		11.09				
	1.6 HDi	80		02.09				
	1.6 HDi 110	82		05.10				
	1.6 HDi 90	66		02.09				
	1.6 HDi 90	68		07.10				
	1.6 VTi 120	88		02.09				
	1.4 VTi 95	70		02.09			BAR22194	266 22,0 20,0 V
	1.6 Flex	78		11.09				
	1.6 HDi	80		02.09				
	1.6 HDi 110	82		05.10				
	1.6 HDi 90	66		02.09				
	1.6 HDi 90	68		07.10				
	1.6 VTi 120	88		02.09				
	1.4 VTi 95	70		02.09			BAR22194	266 22,0 20,0 V
	1.6 Flex	78		11.09				
	1.6 HDi	80		02.09				
	1.6 HDi 110	82		05.10				
	1.6 HDi 90	66		02.09				
	1.6 HDi 90	68		07.10				
	1.6 VTi 120	88		02.09				
	1.4 VTi 95	70		02.09			BAR26120	283 26,0 24,0 V
	1.6 Flex	78		11.09				
	1.6 HDi	80		02.09				
	1.6 HDi 110	82		05.10				
	1.6 HDi 90	66		02.09				
	1.6 HDi 90	68		07.10				
	1.6 VTi 120	88		02.09				
<b>CITROEN C3 Pluriel (03-10)</b>								
	1.4 HDi	50		04.04	07.10		BAR22194	266 22,0 20,0 V
	1.4 Hybrid	54		05.05	07.10			
	1.4 i	54		05.03	07.10			
	1.6 16V	80		05.03	07.10			
	1.6 16V	80		05.03	07.10		BA2017	20961 17,2 /S LUC
	1.6 16V	80		05.03	07.10		BAR09137	247 9,0 8,0
<b>CITROEN C3 II (09-)</b>								
	1.1	44		09.09			BA2282	23407 19,3 /S LUC
	1.4	54		09.09				
	1.4 Flex	58		11.09				
	1.4 HDi 70	50		11.09				
	1.4 VTi 95	70		09.09			BA2214	+ 16" Rad <sup>3)</sup> 23599 19,0 /S BOS
	1.6 HDi	68		11.09				
	1.6 HDi 90	66		09.09				
	1.6 VTi 120	88		09.09		+ BVM- Getriebe <sup>4)</sup>		
	1.6 Flex	81	ORGA 10800	11.09			BA2289	23708 18,4 /S BOS
	1.6 HDi 110	82	ORGA 10800	09.09				
1.6 VTi 120	88	ORGA 10800	09.09		+ BVA- Getriebe <sup>5)</sup>			
	1.6 Flex	81	ORGA 10801				BA2229	23600 19,0 /S BOS
	1.6 HDi 110	82	ORGA 10801					
	1.6 VTi 120	88	ORGA 10801			+ BVA- Getriebe <sup>5)</sup>		
	1.1	44	ORGA 11787	09.09			BAR13184	266 13,0 11,0
	1.4	54	ORGA 11787	09.09				
	1.4 Flex	58	ORGA 11787	11.09				
	1.4 HDi 70	50	ORGA 11787	11.09				
	1.1	44	ORGA 11788				BAR13184	266 13,0 11,0
	1.4	54	ORGA 11788					
	1.4 Flex	58	ORGA 11788					
1.4 HDi 70	50	ORGA 11788						
1.4 VTi 95	70	ORGA 11402	09.09			BAR22194	266 22,0 20,0 V	

1) + manual transmission / + scatola cambio velocità / + transmission mécanique / + cambio de velocidad  
2) + autom.transmission / + scatola cambio automatico / + transmission automatique / + cambio automatico  
3) + 16" wheel / + ruota 16" / + roue 16" / + rueda 16"  
4) + BVM transmission / + scatola cambio BVM / + boîte de vitesse BVM / + cambio BVM  
5) + BVA transmission / + scatola cambio BVA / + boîte de vitesse BVA / + cambio BVA

									
<b>CITROEN C3 II (09-)</b>									
	1.6 HDi	68	ORGA 11402	11.09			BAR22194	266 22,0 20,0 V	
	1.6 HDi 90	66	ORGA 11402	09.09					
	1.6 VTi 120	88	ORGA 11402	09.09	+ BVM- Getriebe 1)				
	1.4 VTi 95	70	ORGA 11403				BAR22194	266 22,0 20,0 V	
	1.6 HDi	68	ORGA 11403						
	1.6 HDi 90	66	ORGA 11403						
	1.6 VTi 120	88	ORGA 11403		+ BVM- Getriebe 1)				
	1.6 Flex	81		11.09			BAR26120	283 26,0 24,0 V	
	1.6 HDi 110	82		09.09					
	1.6 VTi 120	88		09.09	+ BVA- Getriebe 2)				
	1.6 Flex	81		11.09			BA2017	20961 17,2 /S LUC	
	1.6 HDi	68		11.09					
	1.6 HDi 110	82		09.09					
	1.6 HDi 90	66		09.09					
	1.6 VTi 120	88		09.09					
	1.6 Flex	81		11.09			BAR09137	247 9,0 8,0	
	1.6 HDi	68		11.09					
	1.6 HDi 110	82		09.09					
	1.6 HDi 90	66		09.09					
	1.6 VTi 120	88		09.09					
<b>CITROEN C4 I Limousine (04-)</b>									
	1.4 16V	65		10.04	- ESP		BA2214	23599 19,0 /S BOS	
	1.4 16V	65	ORGA 10551		+ ESP				
	1.6 16V	80		10.04	- ESP				
	1.6 16V	80	ORGA 10551		+ ESP/ + Schaltgetriebe 3)				
	1.6 16V Bio Flex	80		09.07	- ESP				
	1.6 16V Bio Flex	80	ORGA 10551		+ ESP/ + Schaltgetriebe 3)				
	1.6 HDi 110	80		10.04	- ESP				
	1.6 HDi 110	80	ORGA 10551		+ ESP				
	1.6 HDi 90	66		10.04	- ESP				
	1.6 HDi 90	66	ORGA 10551		+ ESP				
	1.6 VTi 120	88		07.08	- ESP				
	1.6 VTi 120	88	ORGA 10551		+ ESP				
		1.4 16V	65	ORGA 10550	10.04	+ ESP		BA2229	23600 19,0 /S BOS
1.6 16V		80	ORGA 10550	10.04	+ ESP/ + Schaltgetriebe 3)				
1.6 16V		80		10.04	+ Automatikgetriebe 4)				
1.6 16V Bio Flex		80	ORGA 10550	09.07	+ ESP/ + Schaltgetriebe 3)				
1.6 HDi 110		80	ORGA 10550	10.04	+ ESP				
1.6 HDi 90		66	ORGA 10550	10.04	+ ESP				
1.6 THP 140		103		07.08					
1.6 THP 150		110		07.08					
2.0 16V		100		10.04					
2.0 16V		103		10.04					
		1.4 16V	65	ORGA 10550	10.04	+ ESP		BAR22194	266 22,0 20,0 V
		1.4 16V	65	ORGA 10551		+ ESP			
		1.6 16V	80		10.04	- ESP			
	1.6 16V	80	ORGA 10551		+ ESP/ + Schaltgetriebe 3)				
	1.6 16V Bio Flex	80		09.07	- ESP				
	1.6 16V Bio Flex	80	ORGA 10551		+ ESP/ + Schaltgetriebe 3)				
	1.6 HDi 110	80		10.04	- ESP				
	1.6 HDi 110	80	ORGA 10551		+ ESP				
	1.6 HDi 90	66		10.04	- ESP				
	1.6 HDi 90	66	ORGA 10551		+ ESP				
	1.6 VTi 120	88	ORGA 10551		+ ESP				
	1.6 VTi 120	88		07.08	- ESP				
		1.4 16V	65	ORGA 10550	10.04	+ ESP		BAR26120	283 26,0 24,0 V
1.6 16V		80	ORGA 10550	10.04	+ ESP/ + Schaltgetriebe 3)				
1.6 16V		80		10.04	+ Automatikgetriebe 4)				
1.6 16V Bio Flex		80	ORGA 10550	09.07	+ ESP/ + Schaltgetriebe 3)				
1.6 HDi 110		80	ORGA 10550	10.04	+ ESP				
1.6 HDi 90		66	ORGA 10550	10.04	+ ESP				
1.6 THP 140		103	ORGA 10550	07.08	+ ESP				
1.6 THP 150		110	ORGA 10550	07.08	+ ESP				
1.6 VTi 120		88	ORGA 10550	07.08	+ ESP				
2.0 16V		100		10.04					
2.0 16V		103		10.04					
		1.4	70		11.09			BAR22194	266 22,0 20,0 V
		1.6 HDi	68		11.09	- elektrische Feststellbremse 5)			
	1.6 16V	88		11.09			BAR26120	283 26,0 24,0 V	
	1.6 HDi	68		11.09	+ elektrische Feststellbremse 6)				
	1.6 HDi	82		11.09					
	1.4 16V	65		10.04			BA2300	24150 17,6 /S BOS	
	1.6 16V	80		10.04			BA2017	20961 17,2 /S LUC	
	1.6 16V Bio Flex	80		09.07					
	1.6 HDi 110	80		10.04					
	1.6 HDi 90	66		10.04					
	1.6 THP 140	103		07.08					
	1.6 THP 150	110		07.08					
	1.6 VTi 120	88		07.08					
	2.0 16V	100		10.04					
2.0 16V	103		10.04						
2.0 16V	130		11.04						
2.0 HDi	103		07.08						
2.0 HDi 135	100		10.04						

1) + BVM transmission / + scatola cambio BVM / + boîte de vitesse BVM / + cambio BVM

2) + BVA transmission / + scatola cambio BVA / + boîte de vitesse BVA / + cambio BVA



















3) + ESP/ + manual transm. / + ESP/+ scatola cambio velocità / + ESP/ + transmission mécanique / + ESP/ + cambio de velocidad

4) + autom.transmission / + scatola cambio automatico / + transmission automatique / + cambio automático





















5) - electric parking brake / - freno a mano elettrico / - frein à main électrique / - freno de mano eléctrico

6) + electric parking brake / + freno a mano elettrico / + frein à main électrique / + freno de mano eléctrico



















									
<b>CITROEN C4 I Coupe (04-10)</b>									
	1.4 16V	65		10.04	07.10	- ESP	BA2214	23599 19,0 /S	BOS
	1.4 16V	65 ORGA 10551			07.10	+ ESP			
	1.6 16V	80		10.04	07.10	- ESP/ + Schaltgetriebe <sup>1)</sup>			
	1.6 16V	80 ORGA 10551			07.10	+ ESP/ + Schaltgetriebe <sup>2)</sup>			
	1.6 HDi 110	80		10.04	07.10	- ESP			
	1.6 HDi 110	80 ORGA 10551			07.10	+ ESP			
	1.6 HDi 90	66		10.04	07.10	- ESP			
	1.6 HDi 90	66 ORGA 10551			07.10	+ ESP			
	1.6 VTi 120	88		07.08	07.10	- ESP/ + Schaltgetriebe <sup>1)</sup>			
	1.6 VTi 120	88 ORGA 10551			07.10	+ ESP/ + Schaltgetriebe <sup>2)</sup>			
	1.4 16V	65	ORGA 10550	10.04		+ ESP	BA2229	23600 19,0 /S	BOS
	1.6 16V	80	ORGA 10550	10.04		+ ESP/ + Schaltgetriebe <sup>2)</sup>			
	1.6 16V	80		10.04	07.10	+ Automatikgetriebe <sup>3)</sup>			
	1.6 HDi 110	80	ORGA 10550	10.04		+ ESP			
	1.6 HDi 90	66	ORGA 10550	10.04		+ ESP			
	1.6 THP 150	110	ORGA 10550	07.08		+ ESP			
	1.6 VTi 120	88	ORGA 10550	07.08		+ ESP			
	2.0 16V	100		10.04	07.10				
	2.0 16V	103		12.05	07.10				
	2.0 HDi	103		07.08	07.10				
	1.4 16V	65		10.04	07.10	- ESP	BAR22194	266 22,0 20,0 V	
	1.4 16V	65 ORGA 10551			07.10	+ ESP			
	1.6 16V	80		10.04	07.10	- ESP/ + Schaltgetriebe <sup>1)</sup>			
	1.6 16V	80 ORGA 10551			07.10	+ ESP/ + Schaltgetriebe <sup>2)</sup>			
	1.6 HDi 110	80		10.04	07.10	- ESP			
	1.6 HDi 110	80 ORGA 10551			07.10	+ ESP			
	1.6 HDi 90	66		10.04	07.10	- ESP			
	1.6 HDi 90	66 ORGA 10551			07.10	+ ESP			
	1.6 VTi 120	88		07.08	07.10	- ESP/ + Schaltgetriebe <sup>1)</sup>			
	1.6 VTi 120	88 ORGA 10551			07.10	+ ESP/ + Schaltgetriebe <sup>2)</sup>			
	1.4 16V	65	ORGA 10550	10.04		+ ESP	BAR26120	283 26,0 24,0 V	
	1.6 16V	80	ORGA 10550	10.04		+ ESP/ + Schaltgetriebe <sup>2)</sup>			
	1.6 16V	80		10.04	07.10	+ Automatikgetriebe <sup>3)</sup>			
	1.6 HDi 110	80	ORGA 10550	10.04		+ ESP			
	1.6 HDi 90	66	ORGA 10550	10.04		+ ESP			
	1.6 THP 150	110	ORGA 10550	07.08		+ ESP			
	1.6 VTi 120	88	ORGA 10550	07.08		+ ESP/ + Schaltgetriebe <sup>2)</sup>			
	2.0 16V	100		10.04	07.10				
	2.0 16V	103		12.05	07.10				
	2.0 HDi	103		07.08	07.10				
	1.4 16V	65		10.04	07.10		BA2300 BA2017	24150 17,6 /S 20961 17,2 /S	BOS LUC
	1.6 16V	80		10.04	07.10				
	1.6 HDi 110	80		10.04	07.10				
	1.6 HDi 90	66		10.04	07.10				
	1.6 THP 150	110		07.08	07.10				
	1.6 VTi 120	88		07.08	07.10				
	2.0 16V	100		10.04	07.10				
	2.0 16V	103		12.05	07.10				
	2.0 16V	130		10.04	07.10				
	2.0 HDi	103		07.08	07.10				
2.0 HDi 135	100		10.04	07.10					
<b>CITROEN C4 I Grand Picasso (06-)</b>									
	1.6 HDi 110	80		10.06			BAR26120	283 26,0 24,0 V	
	1.6 THP 140	103		07.08					
	1.6 THP 150	110		10.08					
	1.6 VTi 120	88		07.08					
	1.8 16V	92		10.06					
<b>CITROEN C4 I Picasso (07-)</b>									
	1.6 HDi	80		02.07			BAR26120	283 26,0 24,0 V	
	1.6 THP 140	103		07.08					
	1.6 THP 150	110		10.08					
	1.6 VTi	88		07.08					
	1.6 VTi 120	88		07.08					
	1.8 i 16V	92		02.07					
<b>CITROEN C5 I Limousine (01-04)</b>									
	1.8 16V	85		03.01	08.04		BAR22194 BAR26120	266 22,0 20,0 V 283 26,0 24,0 V	
	2.0 16V	100		03.01	08.04				
	2.0 16V	103		03.01	08.04				
	2.0 HDi 110	80		03.01	08.04				
	2.0 HDi 90	66		03.01	08.04				
<b>CITROEN C5 I Kombi (01-04)</b>									
	1.8 16V	85		06.01	08.04		BAR26120	283 26,0 24,0 V	
	2.0 16V	100		06.01	08.04				
	2.0 16V	103		06.01	08.04				
	2.0 HDi 110	80		06.01	08.04				
	2.0 HDi 90	66		06.01	08.04				
<b>CITROEN C5 II Limousine (04-08)</b>									
	1.8 16V	85		09.04	01.08		BAR22194 BAR26120	266 22,0 20,0 V 283 26,0 24,0 V	
	1.8 16V	92		09.05	01.08				
	1.6 HDi	80		09.04	01.08				
	2.0 16V	103		09.04	01.08				
	2.0 HDi	100		09.04	01.08				

1) - ESP/ + manual transm. / - ESP/+ scatola cambio velocità / - ESP/ + transmission mécanique / - ESP/ + cambio de velocidad  
2) + ESP/ + manual transm. / + ESP/+ scatola cambio velocità / + ESP/ + transmission mécanique / + ESP/ + cambio de velocidad  
3) + autom.transmission / + scatola cambio automatico / + transmission automatique / + cambio automático

									
<b>CITROEN C5 II Kombi (04-08)</b>									
	1.6 HDi 1.8 16V 1.8 16V 2.0 16V	80 85 92 103	09.04 09.04 09.05 09.04	01.08 01.08 01.08 01.08	BAR26120			283 26,0 24,0 V	
<b>CITROEN C5 III Limousine (X7) (08-)</b>									
	1.6 HDi 1.6 HDi 110 1.6 THP 155 1.6 VTi 120 1.8 16V 2.0 16V 2.0 16V BioFlex 2.0 HDi 2.0 HDi 2.0 HDi 140 2.2 HDi 2.2 HDi 200 2.7 HDi 3.0 3.0 HDi 240 3.0 V6	80 82 115 88 92 103 103 100 120 103 125 150 150 152 177 155	02.08 07.10 04.09 07.10 02.08 02.08 02.08 02.08 04.09 11.08 02.08 07.10 02.08 02.08 04.09 02.08	+ elektrische Feststellbremse <sup>1)</sup> + elektrische Feststellbremse <sup>1)</sup> + elektrische Feststellbremse <sup>1)</sup> + elektrische Feststellbremse <sup>1)</sup> + elektrische Feststellbremse <sup>1)</sup> + elektrische Feststellbremse <sup>1)</sup> + elektrische Feststellbremse <sup>1)</sup> + elektrische Feststellbremse <sup>1)</sup> + elektrische Feststellbremse <sup>1)</sup> + elektrische Feststellbremse <sup>1)</sup> + elektrische Feststellbremse <sup>1)</sup> + elektrische Feststellbremse <sup>1)</sup> + elektrische Feststellbremse <sup>1)</sup> + elektrische Feststellbremse <sup>1)</sup> + elektrische Feststellbremse <sup>1)</sup> + elektrische Feststellbremse <sup>1)</sup>	BA2235			23482 16,4 +	ATE
<b>CITROEN C5 III Kombi (X7) (08-)</b>									
	1.6 HDi 1.6 HDi 110 1.6 THP 155 1.6 VTi 120 1.8 16V 2.0 16V 2.0 16V BioFlex 2.0 HDi 2.0 HDi 2.0 HDi 140 2.2 HDi 2.2 HDi 200 2.7 HDi 3.0 3.0 HDi 240 3.0 V6	80 82 115 88 92 103 103 100 120 103 125 150 150 152 177 155	02.08 07.10 04.09 07.10 02.08 02.08 02.08 02.08 04.09 11.08 02.08 07.10 02.08 02.08 04.09 02.08	+ elektrische Feststellbremse <sup>1)</sup> + elektrische Feststellbremse <sup>1)</sup> + elektrische Feststellbremse <sup>1)</sup> + elektrische Feststellbremse <sup>1)</sup> + elektrische Feststellbremse <sup>1)</sup> + elektrische Feststellbremse <sup>1)</sup> + elektrische Feststellbremse <sup>1)</sup> + elektrische Feststellbremse <sup>1)</sup> + elektrische Feststellbremse <sup>1)</sup> + elektrische Feststellbremse <sup>1)</sup> + elektrische Feststellbremse <sup>1)</sup> + elektrische Feststellbremse <sup>1)</sup> + elektrische Feststellbremse <sup>1)</sup> + elektrische Feststellbremse <sup>1)</sup> + elektrische Feststellbremse <sup>1)</sup> + elektrische Feststellbremse <sup>1)</sup>	BA2235			23482 16,4 +	ATE
<b>CITROEN C8 (02-)</b>									
	2.0 16V 2.0 16V 2.0 HDi 2.0 HDi 2.0 HDi 135 2.2 16V 2.2 HDi	100 103 79 88 100 116 94	07.02 09.05 07.02 02.07 03.06 07.02 07.02		BA2285			20261 19,3 +/WK/S	LUC
	2.0 16V 2.0 16V 2.0 HDi 2.0 HDi 2.0 HDi 135 2.2 16V 2.2 HDi	100 103 79 88 100 116 94	07.02 09.05 07.02 03.06 07.02 07.02		BAR28136			285 28,0 26,0 V	
	2.0 HDi 2.0 16V 2.0 16V 2.0 HDi 2.0 HDi 2.0 HDi 135 2.2 16V 2.2 HDi 2.2 HDi 3.0 V6	88 100 103 79 88 100 116 94 125 150	02.07 07.02 09.05 07.02 02.07 03.06 07.02 07.02 09.07 07.02		BAR28136 BA2017			285 28,0 26,0 V 20961 17,2 /S	LUC
<b>CITROEN C-CROSSER (07-)</b>									
	2.2 HDi 2.4	115 125	02.07 08.08		BA2249			21363 16,0 +/WK	AKE
<b>CITROEN DS3 (09-)</b>									
	1.4 VTi 95 1.6 HDi 110 1.6 HDi 90	70 82 68	04.10 11.09 11.09		BA2214			23599 19,0 /S	BOS
	1.4 VTi 95 1.6 HDi 110 1.6 HDi 90	70 82 68	04.10 11.09 11.09		BAR22194			266 22,0 20,0 V	
	1.6 THP 150 1.6 VTi 120	115 88	04.10 04.10		BAR26120			283 26,0 24,0 V	
	1.6 Racing	ORGA 12271			BAR22194			266 22,0 20,0 V	

<sup>1)</sup> + electric parking brake / + freno a mano elettrico / + frein à main électrique / + freno de mano eléctrico

								
<b>CITROEN DS4 (11-)</b>								
	1.6 e-HDi 110 1.6 HDi 110 1.6 THP 155 1.6 VTi 120 2.0 HDi 160	81 82 115 88 120		04.11 04.11 04.11 04.11 04.11		BAR26120		283 26,0 24,0 V
<b>CITROEN EVASION (94-02)</b>								
	1.8 1.8 1.9 i 1.9 TD 2.0 16V 2.0 HDi 2.0 i 2.0 TD 2.0 Turbo 2.1 TD	73 76		05.97 07.02 02.96 12.96 10.95 12.98 02.95 07.02 12.98 07.02 08.99 07.02 06.94 07.02 05.97 07.02 06.94 07.02 05.96 07.02		BA2079 BA2047		23042 18,7 /WK BDX 21801 19,0 +/WK/S LUC
	1.8 1.8 1.9 i 1.9 TD 2.0 16V 2.0 HDi 2.0 i 2.0 TD 2.0 Turbo 2.1 TD	73 76		05.97 07.02 02.96 12.96 10.95 12.98 02.95 07.02 12.98 07.02 08.99 07.02 06.94 07.02 05.97 07.02 06.94 07.02 05.96 07.02		BAR20155 BAR26104		258 20,0 18,2 V L 281 26,0 24,2 V
	1.8 1.8 1.9 i 1.9 TD 2.0 HDi 2.0 i 2.0 TD	73 76		05.97 07.02 - ABS 02.96 12.96 - ABS 10.95 12.98 - ABS 02.95 07.02 - ABS 08.99 07.02 - ABS 06.94 07.02 - ABS 05.97 07.02 - ABS		BAW1906		Rz 19,05
	1.8 1.8 1.9 i 1.9 TD 2.0 HDi 2.0 i 2.0 TD	73 76		05.97 07.02 - ABS 02.96 12.96 - ABS 10.95 12.98 - ABS 02.95 07.02 - ABS 08.99 07.02 - ABS 06.94 07.02 - ABS 05.97 07.02 - ABS		BAE5037		255 x 61
<b>CITROEN JUMPER Bus (94-02)</b>								
	1.9 D (10) 1.9 TD (10/14) 1.9 TD (10/14) 2.0 i (10/14) 2.5 D (14) 2.5 TD (14) 2.5 TDi (14)	51 66 68 80 63 76 79		01.99 12.99 08.94 12.99 02.94 12.99 02.94 12.99 08.94 12.99 08.94 12.99 12.96 12.99		BA2045		21797 19,7 +/WK/S LUC
	1.9 D (10) 1.9 TD (10/14) 1.9 TD (10/14) 2.0 i (10/14) 2.5 D (14) 2.5 TD (14) 2.5 TDi (14) 2.8 HDi (14)	51 66 68 80 63 76 79 94		01.00 10.01 01.00 10.01 01.00 10.01 01.00 10.01 01.00 10.01 01.00 10.01 01.00 11.00 09.00 10.01		BA2325		23602 19,7 +/WK/S LUC
	1.9 D (10) 1.9 TD (10/14) 1.9 TD (10/14) 2.0 i (10/14) 2.5 D (14) 2.5 TD (14) 2.8 HDi (14)	51 66 68 80 63 76 94		11.01 03.02 11.01 03.02 11.01 03.02 11.01 03.02 11.01 03.02 11.01 03.02 11.01 03.02		BA2241		23917 19,0 +/WK/Zub BRE
	2.0 i (18) 2.5 D (18) 2.5 TD (18) 2.5 TDi (18)	80 63 76 79		02.94 12.99 08.94 12.99 08.94 12.99 12.96 12.99		BA2046		21799 19,7 +/WK/S LUC
	2.0 i (18) 2.5 D (18) 2.5 TD (18) 2.8 HDi (18)	80 63 76 94		11.01 03.02 11.01 03.02 11.01 03.02 11.01 03.02		BA2324		23919 18,3 +/WK/Zub BRE
	1.9 D (10) 1.9 TD (10/14) 1.9 TD (10/14) 2.0 i (10/14) 2.5 D (14)	51 66 68 80 63		01.99 10.01 08.94 10.01 02.94 10.01 02.94 10.01 08.94 10.01		BAR18108		280 18,0 15,9
	1.9 D (10) 1.9 TD (10/14) 1.9 TD (10/14) 2.0 i (10/14) 2.5 D (14) 2.5 TD (14) 2.5 TDi (14) 2.8 HDi (14)	51 66 68 80 63 76 79 94		11.01 03.02 11.01 03.02 11.01 03.02 11.01 03.02 11.01 03.02 08.94 03.02 12.96 11.00 09.00 03.02		BAR24127		280 24,0 21,9 V

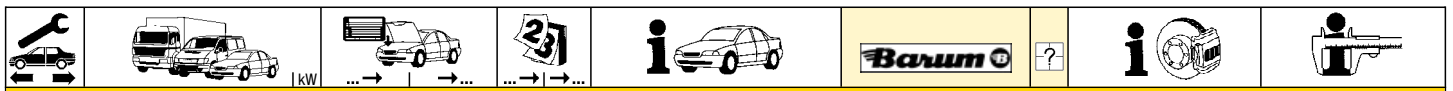





























**CITROEN JUMPER Bus (94-02)**





















	2.0 i (18) 2.5 D (18) 2.5 TD (18) 2.5 TDi (18) 2.8 HDi (18)	80 63 76 79 94		02.94 08.94 08.94 12.96 09.00	03.02 03.02 03.02 11.00 03.02	BAR24138		300 24,0 21,9 V	
	1.9 D (10) 1.9 TD (10/14) 1.9 TD (10/14) 2.0 i (10/14/18) 2.5 D (14/18) 2.5 TD (14/18) 2.8 HDi (14/18)	51 66 68 80 63 76 94		11.01 11.01 11.01 11.01 11.01 11.01 11.01	03.02 03.02 03.02 03.02 03.02 03.02 03.02	BA2323		23921 20,0 /Zub	BRE
	2.5 TD (14) 2.5 TDi (14) 2.8 HDi (14)	76 79 94		08.94 12.96 09.00	10.01 11.00 10.01	BAW2600		Rz 26,99	
	1.9 D (10) 1.9 TD (10/14) 1.9 TD (10/14) 2.0 i (10/14) 2.5 D (14) 2.5 TD (14) 2.8 HDi (14)	51 66 68 80 63 76 94		11.01 11.01 11.01 11.01 11.01 11.01 11.01	03.02 03.02 03.02 03.02 03.02 03.02 03.02	BAW2600		Rz 26,99	
	2.0 i (18) 2.5 D (18) 2.5 TD (18) 2.5 TDi (18) 2.8 HDi (18)	80 63 76 79 94		02.94 08.94 08.94 12.96 09.00	10.01 10.01 10.01 11.00 10.01	BAW2800		Rz 28,57	
	1.9 D (10) 1.9 TD (10/14) 1.9 TD (10/14) 2.0 i (10/14) 2.5 D (14) 2.5 TD (14) 2.5 TDi (14) 2.8 HDi (14)	51 66 68 80 63 76 79 94		01.99 08.94 02.94 02.94 08.94 08.94 12.96 09.00	10.01 10.01 10.01 10.01 10.01 10.01 11.00 10.01	BAE5023		254 x 57 HEB	LUC
	1.9 D (10) 1.9 TD (10/14) 1.9 TD (10/14) 2.0 i (10/14) 2.5 D (14) 2.5 TD (14) 2.8 HDi (14)	51 66 68 80 63 76 94		11.01 11.01 11.01 11.01 11.01 11.01 11.01	03.02 03.02 03.02 03.02 03.02 03.02 03.02	BAE5032	- Quick Fit	254 x 57 HEB	AP
	2.0 i (18) 2.5 D (18) 2.5 TD (18) 2.5 TDi (18) 2.8 HDi (18)	80 63 76 79 94		02.94 08.94 08.94 12.96 09.00	10.01 10.01 10.01 11.00 10.01	BAE5042		254 x 57 HEB	LUC

**CITROEN JUMPER Kasten (94-02)**

	1.9 D (10) 1.9 D (10) 1.9 TD (10/14) 1.9 TD (10/14) 2.0 i (10/14) 2.5 D (14) 2.5 TD (14) 2.5 TDi (14)	50 51 66 68 80 63 76 79		07.99 02.94 03.94 03.94 03.94 03.94 03.94 12.96	12.99 12.99 12.99 12.99 12.99 12.99 12.99 12.99	BA2045		21797 19,7 +/WK/S	LUC
	1.9 D (10) 1.9 D (10) 1.9 TD (10/14) 1.9 TD (10/14) 2.0 i (10/14) 2.5 D (14) 2.5 TD (14) 2.5 TDi (14) 2.8 HDi (14)	50 51 66 68 80 63 76 79 94		01.00 01.00 01.00 01.00 01.00 01.00 01.00 01.00 09.00	10.01 10.01 10.01 10.01 10.01 10.01 10.01 11.00 10.01	BA2325		23602 19,7 +/WK/S	LUC
	1.9 D (10) 1.9 D (10) 1.9 TD (10/14) 1.9 TD (10/14) 2.0 HDi (10/14) 2.0 i (10/14) 2.5 D (14) 2.5 TD (14) 2.8 HDi (14)	50 51 66 68 62 80 63 76 94		11.01 11.01 11.01 11.01 11.01 11.01 11.01 11.01 11.01	03.02 03.02 03.02 03.02 03.02 03.02 03.02 03.02 03.02	BA2241		23917 19,0 +/WK/Zub	BRE
	2.0 i (18) 2.5 D (18) 2.5 TD (18) 2.5 TDi (18)	80 63 76 79		03.94 03.94 03.94 12.96	12.99 12.99 12.99 12.99	BA2046		21799 19,7 +/WK/S	LUC
	2.0 HDi (18) 2.0 i (18) 2.5 D (18) 2.5 TD (18) 2.8 HDi (18)	62 80 63 76 94		11.01 11.01 11.01 11.01 11.01	03.02 03.02 03.02 03.02 03.02	BA2324		23919 18,3 +/WK/Zub	BRE

									
<b>CITROEN JUMPER Kasten (94-02)</b>									
	1.9 D (10)	50		07.99	10.01	BAR18108		280 18,0 15,9	
	1.9 D (10)	51		02.94	10.01				
	1.9 TD (10/14)	66		03.94	10.01				
	1.9 TD (10/14)	68		03.94	10.01				
	2.0 i (10/14)	80		03.94	10.01				
	2.5 D (14)	63		03.94	10.01				
	1.9 D (10)	50		11.01	03.02		BAR24127		280 24,0 21,9 V
	1.9 D (10)	51		11.01	03.02				
	1.9 TD (10/14)	66		11.01	03.02				
	1.9 TD (10/14)	68		11.01	03.02				
	2.0 HDi (10/14)	62		11.01	03.02				
	2.0 i (10/14)	80		11.01	03.02				
2.5 D (14)	63		11.01	03.02					
2.5 TD (14)	76		03.94	03.02					
2.5 TDi (14)	79		12.96	11.00					
2.8 HDi (14)	94		09.00	03.02					
2.0 HDi (18)	62		11.01	03.02	BAR24138	300 24,0 21,9 V			
2.0 i (18)	80		11.01	03.02					
2.5 D (18)	63		11.01	03.02					
2.5 TD (18)	76		03.94	03.02					
2.5 TDi (18)	79		12.96	11.00					
2.8 HDi (18)	94		09.00	03.02					
	1.9 D (10)	50		11.01	03.02	BA2323	23921 20,0 /Zub	BRE	
	1.9 D (10)	51		11.01	03.02				
	1.9 TD (10/14)	66		11.01	03.02				
	1.9 TD (10/14)	68		11.01	03.02				
	2.0 HDi (10/14/18)	62		11.01	03.02				
	2.0 i (10/14/18)	80		11.01	03.02				
	2.5 D (14/18)	63		11.01	03.02				
	2.5 TD (14/18)	76		11.01	03.02				
	2.8 HDi (14/18)	94		11.01	03.02				
		2.5 TD (14)	76		03.94				10.01
2.5 TDi (14)		79		12.96	11.00				
2.8 HDi (14)		94		09.00	10.01				
1.9 D (10)		50		11.01	03.02	BAW2600	Rz 26,99		
1.9 D (10)		51		11.01	03.02				
1.9 TD (10/14)		66		11.01	03.02				
1.9 TD (10/14)		68		11.01	03.02				
2.0 HDi (10/14)		62		11.01	03.02				
2.0 i (10/14)		80		11.01	03.02				
2.5 D (14)		63		11.01	03.02				
2.5 TD (14)		76		11.01	03.02				
2.8 HDi (14)		94		11.01	03.02				
2.0 i (18)	80		03.94	10.01	BAW2800	Rz 28,57			
2.5 D (18)	63		03.94	10.01					
2.5 TD (18)	76		03.94	10.01					
2.5 TDi (18)	79		12.96	11.00					
2.8 HDi (18)	94		09.00	10.01					
	1.9 D (10)	50		07.99	10.01	BAE5023	254 x 57 HEB	LUC	
	1.9 D (10)	51		02.94	10.01				
	1.9 TD (10/14)	66		03.94	10.01				
	1.9 TD (10/14)	68		03.94	10.01				
	2.0 i (10/14)	80		03.94	10.01				
	2.5 D (14)	63		03.94	10.01				
	2.5 TD (14)	76		03.94	10.01				
	2.5 TDi (14)	79		12.96	11.00				
	2.8 HDi (14)	94		09.00	10.01				
	1.9 D (10)	50		11.01	03.02	BAE5032	- Quick Fit	254 x 57 HEB	AP
	1.9 D (10)	51		11.01	03.02				
	1.9 TD (10/14)	66		11.01	03.02				
	1.9 TD (10/14)	68		11.01	03.02				
	2.0 HDi (10/14)	62		11.01	03.02				
	2.0 i (10/14)	80		11.01	03.02				
	2.5 D (14)	63		11.01	03.02				
	2.5 TD (14)	76		11.01	03.02				
	2.8 HDi (14)	94		11.01	03.02				
2.0 i (18)	80		03.94	10.01	BAE5042	254 x 57 HEB	LUC		
2.5 D (18)	63		03.94	10.01					
2.5 TD (18)	76		03.94	10.01					
2.5 TDi (18)	79		03.94	11.00					
2.8 HDi (18)	94		09.00	10.01					
<b>CITROEN JUMPER Pritsche/Fahrgestell (94-02)</b>									
	1.9 TD (10/14)	66		03.94	12.99	BA2045	21797 19,7 +/-WK/S	LUC	
	1.9 TD (10/14)	68		03.94	12.99				
	2.0 i (10/14)	80		03.94	12.99				
	2.5 D (14)	63		03.94	12.99				
	2.5 TD (14)	76		03.94	12.99				
	2.5 TDi (14)	79		12.96	12.99				
	1.9 TD (10/14)	66		01.00	10.01	BA2325	23602 19,7 +/-WK/S	LUC	
	1.9 TD (10/14)	68		01.00	10.01				
	2.0 i (10/14)	80		01.00	10.01				
	2.5 D (14)	63		01.00	10.01				
	2.5 TD (14)	76		01.00	10.01				
	2.5 TDi (14)	79		01.00	10.01				
2.8 HDi (14)	94		09.00	10.01					

										
<b>CITROEN JUMPER Pritsche/Fahrgestell (94-02)</b>										
	1.9 TD (10/14)	66	11.01	03.02	BA2241			23917 19,0 +WK/Zub BRE		
	1.9 TD (10/14)	68	11.01	03.02						
	2.0 i (10/14)	80	11.01	03.02						
	2.5 D (14)	63	11.01	03.02						
	2.5 TD (14)	76	11.01	03.02						
	2.5 TDi (14)	79	11.01	03.02						
	2.8 HDi (14)	94	11.01	03.02						
	2.0 i (18)	80	03.94	12.99					BA2046	21799 19,7 +WK/S LUC
	2.5 D (18)	63	03.94	12.99						
	2.5 TD (18)	76	03.94	12.99						
	2.5 TDi (18)	79	12.96	12.99						
	2.0 i (18)	80	11.01	03.02					BA2324	23919 18,3 +WK/Zub BRE
2.5 D (18)	63	11.01	03.02							
2.5 TD (18)	76	11.01	03.02							
2.5 TDi (18)	79	11.01	03.02							
2.8 HDi (18)	94	11.01	03.02							
	1.9 TD (10/14)	66	03.94	10.01	BAR18108		280 18,0 15,9			
	1.9 TD (10/14)	68	03.94	10.01						
	2.0 i (10/14)	80	03.94	10.01						
	2.5 D (14)	63	03.94	10.01						
	1.9 TD (10/14)	66	11.01	03.02	BAR24127	280 24,0 21,9 V				
	1.9 TD (10/14)	68	11.01	03.02						
	2.0 i (10/14)	80	11.01	03.02						
	2.5 D (14)	63	11.01	03.02						
	2.5 TD (14)	76	03.94	03.02						
	2.5 TDi (14)	79	12.96	03.02						
	2.8 HDi (14)	94	09.00	03.02						
	2.0 i (18)	80	03.94	03.02			BAR24138	300 24,0 21,9 V		
2.5 D (18)	63	03.94	03.02							
2.5 TD (18)	76	03.94	03.02							
2.5 TDi (18)	79	12.96	03.02							
2.8 HDi (18)	94	09.00	03.02							
	1.9 TD (10/14)	66	11.01	03.02	BA2323		23921 20,0 /Zub BRE			
	1.9 TD (10/14)	68	11.01	03.02						
	2.0 i (10/14/18)	80	11.01	03.02						
	2.5 D (14/18)	63	11.01	03.02						
	2.5 TD (14/18)	76	11.01	03.02						
	2.5 TDi (14/18)	79	11.01	03.02						
	2.8 HDi (14/18)	94	11.01	03.02						
	2.5 TD (14)	76	03.94	10.01	BAW2600		Rz 26,99			
	2.5 TDi (14)	79	12.96	10.01						
	2.8 HDi (14)	94	09.00	10.01						
	1.9 TD (10/14)	66	11.01	03.02	BAW2600	Rz 26,99				
	1.9 TD (10/14)	68	11.01	03.02						
	2.0 i (10/14)	80	11.01	03.02						
	2.5 D (14)	63	11.01	03.02						
	2.5 TD (14)	76	11.01	03.02						
	2.5 TDi (14)	79	11.01	03.02						
	2.8 HDi (14)	94	11.01	03.02						
	2.0 i (18)	80	03.94	10.01			BAW2800	Rz 28,57		
	2.5 D (18)	63	03.94	10.01						
2.5 TD (18)	76	03.94	10.01							
2.5 TDi (18)	79	12.96	10.01							
2.8 HDi (18)	94	09.00	10.01							
	1.9 TD (10/14)	66	03.94	10.01	BAE5023		254 x 57 HEB LUC			
	1.9 TD (10/14)	68	03.94	10.01						
	2.0 i (10/14)	80	03.94	10.01						
	2.5 D (14)	63	03.94	10.01						
	2.5 TD (14)	76	03.94	10.01						
	2.5 TDi (14)	79	12.96	10.01						
	2.8 HDi (14)	94	09.00	10.01						
	2.0 i (18)	80	03.94	10.01				BAE5032	- Quick Fit	254 x 57 HEB AP
	2.5 D (18)	63	03.94	10.01						
	2.5 TD (18)	76	03.94	10.01						
	2.5 TDi (18)	79	12.96	10.01						
	1.9 TD (10/14)	66	11.01	03.02	BAE5042		254 x 57 HEB LUC			
1.9 TD (10/14)	68	11.01	03.02							
2.0 i (10/14)	80	11.01	03.02							
2.5 D (14)	63	11.01	03.02							
2.5 TD (14)	76	11.01	03.02							
2.5 TDi (14)	79	11.01	03.02							
2.8 HDi (14)	94	11.01	03.02							
<b>CITROEN JUMPER (02-06)</b>										
	2.0 HDi (10/14)	62	04.02	03.06	BA2241		23917 19,0 +WK/Zub BRE			
	2.0 i (10/14)	81	04.02	03.06						
	2.2 HDi (10/14)	74	04.02	03.06						
	2.8 HDi (10/14)	74	04.02	03.06						
	2.0 HDi (18)	62	04.02	03.06	BA2324		23919 18,3 +WK/Zub BRE			
	2.0 i (18)	81	04.02	03.06						
2.2 HDi (18)	74	04.02	03.06							
2.8 HDi (18)	74	04.02	03.06							

	   kW							
<b>CITROEN JUMPER (02-06)</b>								
	2.0 HDi (10/14)	62		04.02	03.06	BAR24127		280 24,0 21,9 V
	2.0 i (10/14)	81		04.02	03.06			
	2.2 HDi (10/14)	74		04.02	03.06			
	2.8 HDi (10/14)			04.02	03.06			
	2.0 HDi (18)	62		04.02	03.06	BAR24138		300 24,0 21,9 V
	2.0 i (18)	81		04.02	03.06			
	2.2 HDi (18)	74		04.02	03.06			
	2.8 HDi (18)			04.02	03.06			
	2.0 HDi (10/14/18)	62		04.02	03.06	BA2323		23921 20,0 /Zub <b>BRE</b>
	2.0 i (10/14/18)	81		04.02	03.06			
	2.2 HDi (10/14/18)	74		04.02	03.06			
	2.8 HDi (10/14/18)			04.02	03.06			
	2.0 HDi (10/14)	62		04.02	03.06	BAW2600		Rz 26,99
	2.0 i (10/14)	81		04.02	03.06			
	2.2 HDi (10/14)	74		04.02	03.06			
	2.8 HDi (10/14)			04.02	03.06			
	2.0 HDi (10/14)	62		04.02	03.06	BAE5032	- Quick Fit	254 x 57 HEB <b>AP</b>
	2.0 i (10/14)	81		04.02	03.06			
	2.2 HDi (10/14)	74		04.02	03.06			
	2.8 HDi (10/14)			04.02	03.06			
<b>CITROEN JUMPER (06-)</b>								
	2.2 HDi 100	74		04.06	Nutzlast 120/140 <sup>1)</sup>	BA2275		24468 18,5 +/WK/Zub <b>BRE</b>
	2.2 HDi 110	81		07.11	Nutzlast 120/140 <sup>1)</sup>			
	2.2 HDi 120	88		04.06	Nutzlast 120/140 <sup>1)</sup>			
	2.2 HDi 130	96		07.11	Nutzlast 120/140 <sup>1)</sup>			
	2.2 HDi 150	110		07.11	Nutzlast 120/140 <sup>1)</sup>			
	3.0 HDi 145	107		07.10	Nutzlast 120/140 <sup>1)</sup>			
	3.0 HDi 155	115		07.10	Nutzlast 120/140 <sup>1)</sup>			
	3.0 HDi 160	116		09.06	Nutzlast 120/140 <sup>1)</sup>			
	3.0 HDi 180	130		07.11	Nutzlast 120/140 <sup>1)</sup>			
		2.2 HDi 100	74		04.06			
2.2 HDi 110		81		07.11	Nutzlast leicht 16Q <sup>2)</sup>			
2.2 HDi 120		88		04.06	Nutzlast leicht 16Q <sup>2)</sup>			
2.2 HDi 130		96		07.11	Nutzlast leicht 16Q <sup>2)</sup>			
2.2 HDi 150		110		07.11	Nutzlast leicht 16Q <sup>2)</sup>			
3.0 HDi 145		107		07.10	Nutzlast leicht 16Q <sup>2)</sup>			
3.0 HDi 155		115		07.10	Nutzlast leicht 16Q <sup>2)</sup>			
3.0 HDi 160		116		09.06	Nutzlast leicht 16Q <sup>2)</sup>			
3.0 HDi 180		130		07.11	Nutzlast leicht 16Q <sup>2)</sup>			
		2.2 HDi 100	74		04.06	Nutzlast schwer 16Q <sup>3)</sup>	BA2328	
	2.2 HDi 110	81		07.11	Nutzlast schwer 16Q <sup>3)</sup>			
	2.2 HDi 120	88		04.06	Nutzlast schwer 16Q <sup>3)</sup>			
	2.2 HDi 130	96		07.11	Nutzlast schwer 16Q <sup>3)</sup>			
	2.2 HDi 150	110		07.11	Nutzlast schwer 16Q <sup>3)</sup>			
	3.0 HDi 145	107		07.10	Nutzlast schwer 16Q <sup>3)</sup>			
	3.0 HDi 155	115		07.10	Nutzlast schwer 16Q <sup>3)</sup>			
	3.0 HDi 160	116		09.06	Nutzlast schwer 16Q <sup>3)</sup>			
	3.0 HDi 180	130		07.11	Nutzlast schwer 16Q <sup>3)</sup>			
		2.2 HDi 100	74		04.06	Nutzlast 120/140 <sup>1)</sup>		
2.2 HDi 110		81		07.11	Nutzlast 120/140 <sup>1)</sup>			
2.2 HDi 120		88		04.06	Nutzlast 120/140 <sup>1)</sup>			
2.2 HDi 130		96		07.11	Nutzlast 120/140 <sup>1)</sup>			
2.2 HDi 150		110		07.11	Nutzlast 120/140 <sup>1)</sup>			
3.0 HDi 145		107		07.10	Nutzlast 120/140 <sup>1)</sup>			
3.0 HDi 155		115		07.10	Nutzlast 120/140 <sup>1)</sup>			
3.0 HDi 160		116		09.06	Nutzlast 120/140 <sup>1)</sup>			
3.0 HDi 180		130		07.11	Nutzlast 120/140 <sup>1)</sup>			
		2.2 HDi 100	74		04.06	Nutzlast schwer 16Q <sup>3)</sup>	BAR24138	
	2.2 HDi 110	81		07.11	Nutzlast schwer 16Q <sup>3)</sup>			
	2.2 HDi 120	88		04.06	Nutzlast schwer 16Q <sup>3)</sup>			
	2.2 HDi 130	96		07.11	Nutzlast schwer 16Q <sup>3)</sup>			
	2.2 HDi 150	110		07.11	Nutzlast schwer 16Q <sup>3)</sup>			
	3.0 HDi 145	107		07.10	Nutzlast schwer 16Q <sup>3)</sup>			
	3.0 HDi 155	115		07.10	Nutzlast schwer 16Q <sup>3)</sup>			
	3.0 HDi 160	116		09.06	Nutzlast schwer 16Q <sup>3)</sup>			
	3.0 HDi 180	130		07.11	Nutzlast schwer 16Q <sup>3)</sup>			
		2.2 HDi 100	74		04.06			
2.2 HDi 110		81		07.11				
2.2 HDi 120		88		04.06				
2.2 HDi 130		96		07.11				
2.2 HDi 150		110		07.11				
3.0 HDi 145		107		07.10				
3.0 HDi 155		115		07.10				
3.0 HDi 160		116		09.06				
3.0 HDi 180		130		07.11				
<b>CITROEN JUMPY Kombi (95-06)</b>								
	1.6		ORGA 09792	10.95		BA2047		21801 19,0 +/WK/S <b>LUC</b>
	1.9 D	51	ORGA 09155	10.95				
	1.9 TD	66	ORGA 09792	10.95				
	1.9 TD	68	ORGA 09792	04.96				
	2.0 16V	100	ORGA 09792	04.00				
	2.0 16V	102	ORGA 09792	03.00				
	2.0 HDi	69	ORGA 09792	10.99				
	2.0 HDi	80	ORGA 09792	03.00				
↓								

<sup>1)</sup> payload 120/140 / carico utile 120/140 / charge utile 120/140 / carga útil 120/140

<sup>2)</sup> light payload 16Q / carico utile leggero 16Q / charge utile légère 16Q / carga útil ligera 16Q

<sup>3)</sup> heavy payload 16Q / carico utile pesante 16Q / charge utile lourde 16Q / carga útil pesada 16Q























**CITROEN JUMPY Kombi (95-06)**

	1.6 1.9 D	51	ORGA 09156	ORGA 09155	<b>10.95</b>	<b>12.06</b>	BA2079	23042 18,7 /WK	<b>BDX</b>
	1.6 1.9 TD	66	ORGA 09793			<b>12.06</b>	BA2285	20261 19,3 +/WK/S	<b>LUC</b>
	2.0 16V	100	ORGA 09793			<b>12.06</b>			
	2.0 16V	102	ORGA 09793			<b>12.06</b>			
	2.0 HDi	69	ORGA 09793			<b>12.06</b>			
	2.0 HDi	80	ORGA 09793			<b>12.06</b>			
	2.0 HDi	80	ORGA 09793			<b>12.06</b>			
	1.6 1.9 D	51	ORGA 09155	ORGA 09155	<b>10.95</b>	<b>10.95</b>	BAR20155	258 20,0 18,2 V L	
	1.9 TD	66	ORGA 09155	ORGA 09155	<b>10.95</b>	<b>10.95</b>			
	1.9 TD	68	ORGA 09155	ORGA 09155	<b>04.96</b>	<b>04.96</b>			
	2.0 16V	100	ORGA 09155	ORGA 09155	<b>04.00</b>	<b>04.00</b>			
	2.0 16V	102	ORGA 09155	ORGA 09155	<b>03.00</b>	<b>03.00</b>			
	2.0 HDi	69	ORGA 09155	ORGA 09155	<b>10.99</b>	<b>10.99</b>			
	2.0 HDi	80	ORGA 09155	ORGA 09155	<b>03.00</b>	<b>03.00</b>			
	1.6 1.9 D	51	ORGA 09792	ORGA 09792	<b>10.95</b>	<b>10.95</b>	BAR26104	281 26,0 24,2 V	
	1.9 TD	66	ORGA 09792	ORGA 09792	<b>10.95</b>	<b>10.95</b>			
	1.9 TD	68	ORGA 09792	ORGA 09792	<b>04.96</b>	<b>04.96</b>			
	2.0 16V	100	ORGA 09792	ORGA 09792	<b>04.00</b>	<b>04.00</b>			
	2.0 16V	102	ORGA 09792	ORGA 09792	<b>03.00</b>	<b>03.00</b>			
	2.0 HDi	69	ORGA 09792	ORGA 09792	<b>10.99</b>	<b>10.99</b>			
	2.0 HDi	80	ORGA 09792	ORGA 09792	<b>03.00</b>	<b>03.00</b>			
	1.6 1.9 D	51	ORGA 09793			<b>12.06</b>	BAR28136	285 28,0 26,0 V	
	1.9 TD	66	ORGA 09793			<b>12.06</b>			
	1.9 TD	68	ORGA 09793			<b>12.06</b>			
	2.0 16V	100	ORGA 09793			<b>12.06</b>			
	2.0 16V	102	ORGA 09793			<b>12.06</b>			
	2.0 HDi	69	ORGA 09793			<b>12.06</b>			
	2.0 HDi	80	ORGA 09793			<b>12.06</b>			
	1.6 1.9 D	51			<b>10.95</b>	<b>12.06</b>	BAW1906	Rz 19,05	
	1.9 TD	66			<b>10.95</b>	<b>12.06</b>			
	1.9 TD	68			<b>04.96</b>	<b>12.06</b>			
	2.0 16V	100			<b>04.00</b>	<b>12.06</b>			
	2.0 16V	102			<b>03.00</b>	<b>12.06</b>			
	2.0 HDi	69			<b>10.99</b>	<b>12.06</b>			
	2.0 HDi	80			<b>03.00</b>	<b>12.06</b>			
	1.6 1.9 D	51			<b>10.95</b>	<b>12.06</b>	BAE5037	255 x 61	
	1.9 TD	66			<b>10.95</b>	<b>12.06</b>			
	1.9 TD	68			<b>04.96</b>	<b>12.06</b>			
	2.0 16V	100			<b>04.00</b>	<b>12.06</b>			
	2.0 16V	102			<b>03.00</b>	<b>12.06</b>			
	2.0 HDi	69			<b>10.99</b>	<b>12.06</b>			
	2.0 HDi	80			<b>03.00</b>	<b>12.06</b>			

**CITROEN JUMPY Kasten (95-06)**

	1.6 1.9 D	51	ORGA 09792	ORGA 09792	<b>10.95</b>	<b>10.95</b>	BA2079	23042 18,7 /WK	<b>BDX</b>
	1.9 TD	66	ORGA 09155	ORGA 09155	<b>10.95</b>	<b>10.95</b>	BA2047	21801 19,0 +/WK/S	<b>LUC</b>
	2.0 16V	102	ORGA 09155	ORGA 09155	<b>10.95</b>	<b>10.95</b>			
	2.0 HDi	69	ORGA 09792	ORGA 09792	<b>03.00</b>	<b>03.00</b>			
	2.0 HDi	69	ORGA 09792	ORGA 09792	<b>10.99</b>	<b>10.99</b>			
	2.0 HDi	80	ORGA 09792	ORGA 09792	<b>01.02</b>	<b>01.02</b>			
	2.0 HDi	80	ORGA 09792	ORGA 09792	<b>01.02</b>	<b>01.02</b>			
	1.6 1.9 D	51	ORGA 09156			<b>12.06</b>	BA2079	23042 18,7 /WK	<b>BDX</b>
	1.9 TD	66	ORGA 09156			<b>12.06</b>			
	1.6 1.9 D	51	ORGA 09793			<b>12.06</b>	BA2285	20261 19,3 +/WK/S	<b>LUC</b>
	2.0 16V	102	ORGA 09793			<b>12.06</b>			
	2.0 HDi	69	ORGA 09793			<b>12.06</b>			
	2.0 HDi	80	ORGA 09793			<b>12.06</b>			
	2.0 HDi	80	ORGA 09793			<b>12.06</b>			
	1.6 1.9 D	51	ORGA 09155	ORGA 09155	<b>10.95</b>	<b>10.95</b>	BAR20155	258 20,0 18,2 V L	
	1.9 TD	66	ORGA 09155	ORGA 09155	<b>04.98</b>	<b>04.98</b>			
	1.9 TD	66	ORGA 09155	ORGA 09155	<b>10.95</b>	<b>10.95</b>			
	2.0 16V	102	ORGA 09155	ORGA 09155	<b>03.00</b>	<b>03.00</b>			
	2.0 HDi	69	ORGA 09155	ORGA 09155	<b>10.99</b>	<b>10.99</b>			
	2.0 HDi	80	ORGA 09155	ORGA 09155	<b>01.02</b>	<b>01.02</b>			
	2.0 HDi	80	ORGA 09155	ORGA 09155	<b>01.02</b>	<b>01.02</b>			
	1.6 1.6		ORGA 09792	ORGA 09792	<b>10.95</b>	<b>10.95</b>	BAR26104	281 26,0 24,2 V	
	1.9 D	51	ORGA 09156	ORGA 09792	<b>10.95</b>	<b>10.95</b>			
	1.9 D	51	ORGA 09156	ORGA 09792	<b>04.98</b>	<b>04.98</b>			
	1.9 TD	66	ORGA 09156	ORGA 09792	<b>10.95</b>	<b>10.95</b>			
	1.9 TD	66	ORGA 09156	ORGA 09792	<b>10.95</b>	<b>10.95</b>			
	2.0 16V	102	ORGA 09156	ORGA 9792					
	2.0 16V	102	ORGA 09156	ORGA 09792	<b>03.00</b>	<b>03.00</b>			
2.0 HDi	69	ORGA 09156	ORGA 09792	<b>10.99</b>	<b>10.99</b>				
2.0 HDi	69	ORGA 09156	ORGA 09792	<b>10.99</b>	<b>10.99</b>				
2.0 HDi	80	ORGA 09156	ORGA 09792	<b>10.99</b>	<b>10.99</b>				
2.0 HDi	80	ORGA 09156	ORGA 09792	<b>01.02</b>	<b>01.02</b>				
	1.6 1.6		ORGA 09793			<b>12.06</b>	BAR28136	285 28,0 26,0 V	
	1.9 D	51	ORGA 09793			<b>12.06</b>			
	1.9 D	51	ORGA 09793			<b>12.06</b>			
	1.9 TD	66	ORGA 09793			<b>12.06</b>			
	1.9 TD	66	ORGA 09793			<b>12.06</b>			
	1.9 TD	66	ORGA 09793			<b>12.06</b>			
	1.9 TD	66	ORGA 09793			<b>12.06</b>			



















								
<b>CITROEN JUMPY Kasten (95-06)</b>								
	2.0 16V 2.0 16V 2.0 HDi 2.0 HDi 2.0 HDi 2.0 HDi	102 ORGA 09793 102 ORGA 09793 69 ORGA 09793 69 ORGA 09793 80 ORGA 09793 80 ORGA 09793		12.06 +0,8 t 12.06 +0,9 t 12.06 +0,8 t 12.06 +0,9 t 12.06 +0,8 t 12.06 +0,9 t		BAR28136		285 28,0 26,0 V
	1.6 1.9 D 1.9 TD 2.0 16V 2.0 HDi 2.0 HDi	51 66 102 69 80		10.95 12.06 04.98 12.06 10.95 12.06 03.00 12.06 10.99 12.06 01.02 12.06		BAW1906		Rz 19,05
	1.6 1.9 D 1.9 TD 2.0 16V 2.0 HDi 2.0 HDi	51 66 102 69 80		10.95 12.06 04.98 12.06 10.95 12.06 03.00 12.06 10.99 12.06 01.02 12.06		BAE5037		255 x 61
<b>CITROEN JUMPY Pritsche/Fahrgestell (99-06)</b>								
	1.9 TD 2.0 HDi	68 69	ORGA 09792 ORGA 09792	10.99 10.99		BA2047		21801 19,0 +/WK/S LUC
	1.9 TD 2.0 HDi	68 ORGA 09793 69 ORGA 09793		12.06 12.06		BA2285		20261 19,3 +/WK/S LUC
	1.9 TD 2.0 HDi	68 69	ORGA 09792 ORGA 09792	10.99 10.99		BAR26104		281 26,0 24,2 V
	1.9 TD 2.0 HDi	68 ORGA 09793 69 ORGA 09793		12.06 12.06		BAR28136		285 28,0 26,0 V
	1.9 TD 2.0 HDi	68 69		10.99 12.06 10.99 12.06		BAW1906		Rz 19,05
	1.9 TD 2.0 HDi	68 69		10.99 12.06 10.99 12.06		BAE5037		255 x 61
<b>CITROEN JUMPY (07-)</b>								
	1.6 HDi 90 2.0 HDi 120 2.0 HDi 125 2.0 HDi 140 2.0 HDi 165 2.0 HDi 95 2.0 i	66 88 94 100 120 72 103		01.07 01.07 07.11 01.07 07.10 07.11 01.07		BA2329		24595 18,9 +/WK/S LUC
	1.6 HDi 90 2.0 HDi 120 2.0 HDi 140 2.0 HDi 165 2.0 i	66 88 100 120 103		01.07 01.07 01.07 07.10 01.07		BA2330		24578 16,3 /S LUC
	1.6 HDi 90	66		01.07		BAE5042		254 x 57 HEB LUC
<b>CITROEN NEMO (08-)</b>								
	1.2 HDi 75 1.3 HDi 75 1.4 HDi 1.4 i	55 55 50 54		10.10 10.10 02.08 02.08	+ Automatikgetriebe <sup>1)</sup>	BAR22197		258 22,0 20,2 V
<b>CITROEN SAXO (96-04)</b>								
	1.0 i 1.1 i			02.96 03.04 02.96 03.04		BA2100 BA2083	für 3-Loch-Felge <sup>2)</sup> für 4-Loch-Felge <sup>3)</sup>	21857 16,8 ATE 20905 18,0 +/WE BDX
	1.4 i 1.5 D 1.5 D	55		02.96 03.04 04.96 03.04 07.01 04.04		BA2083		20905 18,0 +/WE BDX
	1.4 i VTS 1.6 1.6 1.6 1.6 16V VTS 1.6 i 1.6 i VTS	55 66 74 88 87 65 72		05.96 03.04 02.96 06.03 02.01 04.04 02.96 04.04 07.96 03.04 02.96 03.04 09.00 03.04		BA2151		21827 17,3 + ATE
	1.0 i 1.1 i			02.96 03.04 02.96 03.04		BAR08107 BAR10187		238 8,0 6,0 247 10,0 8,0
	1.4 i 1.5 D 1.5 D	55		02.96 03.04 04.96 03.04 07.01 04.04		BAR10187		247 10,0 8,0
	1.4 i VTS 1.6 1.6 1.6 1.6 16V VTS 1.6 i 1.6 i VTS	55 66 74 88 87 65 72		05.96 03.04 02.96 06.03 02.01 04.04 02.96 04.04 07.96 03.04 02.96 03.04 09.00 03.04		BAR20132 BAR20132		247 20,4 18,5 V 247 20,4 18,5 V

<sup>1)</sup> + autom.transmission / + scatola cambio automatico / + transmission automatique / + cambio automático





















<sup>2)</sup> for 3 bore wheel rim / per cerchione a 3 fori / pour jante à 3 trous / para Llantas de 3 taladros

<sup>3)</sup> for 4 bore wheel rim / per cerchione a 4 fori / pour jante à 4 trous / para Llantas de 4 taladros















									
<b>CITROEN SAXO (96-04)</b>									
	1.6 1.6 1.6 1.6 16V VTS 1.6 i VTR 1.6 i VTS	66 74 88 87 65 72		02.96 06.03 02.01 04.04 02.96 04.04 07.96 03.04 02.96 06.03 09.00 03.04		BAR08106		247 8,0 6,0	
	1.0 i 1.1 i			02.96 03.04 - ABS 02.96 03.04 - ABS		BAW1909 BAW1910 BAW1913 BAW1912	<input type="checkbox"/> für 3-Loch-Felge <sup>1)</sup> <input type="checkbox"/> für 3-Loch-Felge <sup>1)</sup> <input type="checkbox"/> für 4-Loch-Felge <sup>2)</sup> <input type="checkbox"/> für 4-Loch-Felge <sup>2)</sup>	RzR 19,05 RzR 19,05 RzR 19,05 RzR 19,05	<b>BDX</b> <b>BDX</b>
	1.4 i 1.5 D 1.5 D 1.6 1.6 i SX/VTL/VSX	55 43 66 65		02.96 03.04 - ABS 04.96 03.04 - ABS 07.01 04.04 - ABS 02.96 06.03 - ABS 02.96 03.04 - ABS		BAW1913 BAW1912	<input type="checkbox"/>	RzR 19,05 RzR 19,05	
	1.0 i 1.1 i 1.4 i 1.5 D 1.5 D 1.6 1.6 i SX/VTL/VSX		ORGA 08095 ORGA 08095 ORGA 08095 ORGA 08095 ORGA 08095 ORGA 08095	02.96 + ABS 02.96 + ABS 02.96 + ABS 04.96 + ABS 07.01 + ABS 02.96 + ABS 02.96 + ABS		BAW2001		Rz 20,64	<b>LUC</b>
	1.0 i 1.1 i			02.96 03.04 - ABS 02.96 03.04 - ABS		BAE5014 BAE5020	für 3-Loch-Felge <sup>1)</sup>	164 x 32 AUT 180 x 32 AUT	<b>BDX</b>
	1.4 i 1.5 D 1.5 D 1.6 1.6 i SX/VTL/VSX	55 43 66 65		02.96 03.04 - ABS 04.96 03.04 - ABS 07.01 04.04 - ABS 02.96 06.03 - ABS 02.96 03.04 - ABS		BAE5020		180 x 32 AUT	<b>BDX</b>
	1.0 i 1.1 i 1.4 i 1.5 D 1.5 D 1.6 1.6 i SX/VTL/VSX			02.96 03.04 + ABS 02.96 03.04 + ABS 02.96 03.04 + ABS 04.96 03.04 + ABS 07.01 04.04 + ABS 02.96 06.03 + ABS 02.96 03.04 + ABS		BAE5002		203 x 38 HEB	<b>LUC</b>
<b>CITROEN XANTIA (X1) Limousine (93-97)</b>									
	1.6 i 1.8 16V 1.8 i 1.8 i 1.9 D 1.9 D 1.9 SD 1.9 TD 2.0 2.0 16V 2.0 16V 2.0 16V 2.0 i	65 81 66 74 50 51 55 66 95 97 110 112 89		03.93 12.97 06.95 12.97 04.97 12.97 03.93 12.97 06.94 12.97 06.94 12.97 02.96 12.97 10.94 12.97 03.93 05.95 06.95 12.97 06.94 12.97 03.93 12.97 03.93 12.97		BA2078		21631 17,0 /WK	<b>BDX</b>
	1.6 i 1.8 16V 1.8 i 1.8 i 1.9 D 1.9 D 1.9 SD 1.9 TD 2.0 i	65 81 66 74 50 51 55 66 89	ORGA 07568	03.93 12.97 06.95 12.97 04.97 12.97 03.93 12.97 06.94 12.97 06.94 12.97 02.96 12.97 10.94 12.97 03.93 12.97		BAR20133		266 20,5 18,5 V	
	2.0 Turbo 2.1 TD	108 80		06.95 12.97 06.95 12.97		BAR26106		283 26,0 24,2 V	
	1.6 i 1.8 16V 1.8 i 1.8 i 1.9 D 1.9 D 1.9 SD 1.9 TD 2.0 2.0 16V 2.0 16V 2.0 16V 2.0 i 2.0 Turbo 2.1 TD 3.0 V6	65 81 66 74 50 51 55 66 95 97 110 112 89 108 80 140		03.93 12.97 06.95 12.97 04.97 12.97 03.93 12.97 06.94 12.97 06.94 12.97 02.96 12.97 10.94 12.97 03.93 05.95 06.95 12.97 06.94 12.97 03.93 12.97 03.93 12.97 06.95 12.97 06.95 12.97 01.97 12.97		BA2106		20162 15,4	<b>CIT</b>
	1.6 i 1.8 16V 1.8 i 1.8 i 1.9 D 1.9 D 1.9 SD 1.9 TD	65 81 66 74 50 51 55 66		03.93 12.97 06.95 12.97 04.97 12.97 03.93 12.97 06.94 12.97 06.94 12.97 02.96 12.97 10.94 12.97		BAR09122		224 9,0 7,0	

















<sup>1)</sup> for 3 bore wheel rim / per cerchione a 3 fori / pour jante à 3 trous / para Llantas de 3 taladros















<sup>2)</sup> for 4 bore wheel rim / per cerchione a 4 fori / pour jante à 4 trous / para Llantas de 4 taladros

								
<b>CITROEN XANTIA (X1) Limousine (93-97)</b>								
	2.0	95	03.93	05.95	BAR09122			224 9,0 7,0
	2.0 16V	97	06.95	12.97				
	2.0 16V	110	06.94	12.97				
	2.0 16V	112	03.93	12.97				
	2.0 i	89	03.93	12.97				
	2.0 Turbo	108	06.95	12.97				
	2.1 TD	80	06.95	12.97				
	3.0 V6	140	01.97	12.97				
<b>CITROEN XANTIA (X1) Kombi (95-97)</b>								
	1.8 16V	81	06.95	12.97	BA2078			21631 17,0 /WK BDX
	1.8 i	66	04.97	12.97				
	1.8 i	74	06.95	12.97 - ABS				
	1.8 i	74 ORGA 07483	12.97	+ ABS				
	1.8 16V	81	06.95	12.97	BAR20133			266 20,5 18,5 V
	1.8 i	66	04.97	12.97				
	1.8 i	74	06.95	12.97 - ABS				
	1.8 i	74 ORGA 07483	12.97	+ ABS				
	2.0 Turbo	108	06.95	12.97	BAR26106			283 26,0 24,2 V
	2.1 TD	80	06.96	12.97				
<b>CITROEN XANTIA (X2) Limousine (98-03)</b>								
	1.8 16V	81	01.98	09.01	BA2078			21631 17,0 /WK BDX
	1.8 i	66	01.98	09.01				
	1.9 SD	55	01.98	09.01				
	1.9 TD	66	01.98	09.01 + Schaltgetriebe 1)				
	2.0 HDi 90	66	03.99	04.03				
	1.8 16V	81	01.98	09.01	BAR20133			266 20,5 18,5 V
	1.8 i	66	01.98	09.01				
	1.9 SD	55	01.98	09.01				
	1.9 TD	66	01.98	09.01 + Schaltgetriebe 1)				
	2.0 HDi 90	66	03.99	04.03				
	2.0 16V ACTIVA	97	ORGA 08000	01.98	BAR26106			283 26,0 24,2 V
	2.0 Turbo	108	ORGA 08000	01.98				
	2.1 TD	80	ORGA 08000	01.98				
	1.8 16V	81	01.98	09.01	BA2106			20162 15,4 CIT
	1.8 i	66	01.98	09.01				
	1.9 SD	55	01.98	09.01				
	1.9 TD	66	01.98	09.01				
	2.0 16V	97	01.98	09.01				
	2.0 HDi 110	109	02.99	09.01				
	2.0 HDi 90	66	03.99	09.01				
	2.0 i	89	01.98	09.01				
	2.0 Turbo	108	01.98	09.01				
	2.1 TD	80	01.98	02.99				
	3.0 V6	140	01.98	09.01				
	1.8 16V	81	01.98	09.01	BAR09122			224 9,0 7,0
	1.8 i	66	01.98	09.01				
	1.9 SD	55	01.98	09.01				
	1.9 TD	66	01.98	09.01				
	2.0 16V	97	01.98	09.01				
	2.0 HDi 110	109	02.99	09.01				
	2.0 HDi 90	66	03.99	09.01				
	2.0 i	89	01.98	09.01				
	2.0 Turbo	108	01.98	09.01				
	2.1 TD	80	01.98	02.99				
	3.0 V6	140	01.98	09.01				
<b>CITROEN XANTIA (X2) Kombi (98-03)</b>								
	1.8 16V	81	01.98	09.01	BA2078			21631 17,0 /WK BDX
	1.8 i	66	01.98	09.01				
	1.8 16V	81	01.98	09.01	BAR20133			266 20,5 18,5 V
	1.8 i	66	01.98	09.01				
	2.0 Turbo	108	ORGA 08000	01.98	BAR26106			283 26,0 24,2 V
	2.1 TD	80	ORGA 08000	01.98				
	2.0 i	89	01.98	09.01	BA2106			20162 15,4 CIT
	2.0 i	89	01.98	09.01	BAR09122			224 9,0 7,0
<b>CITROEN XM (Y3) Limousine (89-94)</b>								
	2.0	84	05.89	04.94	BA2106			20162 15,4 CIT
	2.0 i	89	05.89	06.94				
	2.0 Turbo	104	09.92	06.94				
	2.1 D	60	05.89	06.94				
	2.1 TD	80	05.89	06.94				
	3.0 24V	147	07.90	06.94				
	3.0 V6	123	05.89	06.94				

1) + manual transmission / + scatola cambio velocità / + transmission mécanique / + cambio de velocidad

										
<b>CITROEN XM (Y4) Limousine (94-00)</b>										
	2.0 16V	97		05.94	10.00		BA2106		20162 15,4	CIT
	2.0 Turbo	108		05.94	10.00					
	2.1 TD	80		05.94	10.00					
	2.5 TD	95		05.94	10.00					
	3.0 24V	147		05.94	10.00					
	3.0 V6	123		05.94	10.00					
	3.0 V6	140		04.97	10.00					
<b>CITROEN XSARA (N1) Limousine (97-05)</b>										
	1.4 i	55		04.97	08.00	- ABS	BA2090		21980 18,0 +/-WE/S	BOS
	1.5 D	42		04.97	08.00	- ABS				
	1.4 i	55		04.97	08.00	+ ABS	BA2151		21827 17,3 +	ATE
	1.5 D	42		04.97	08.00	+ ABS				
	1.6 i	65		04.97	08.00					
	1.8 D	43		04.97	08.00					
	1.8 i	66		04.97	08.00					
	1.8 i	74		04.97	08.00	- (BR)				
	1.8 TD	66		10.97	08.00					
	1.9 D	50		04.97	08.00					
	1.9 D	51		07.98	08.00					
	1.9 SD	55		01.98	08.00					
	1.9 TD	66		04.97	08.00					
	1.8 16V	81		04.97	08.00		BA2021		23124 19,0 +/-WK/S	LUC
	1.8 i	74		04.97	08.00	+ (BR)				
	2.0 16V	97		07.98	08.00					
	2.0 HDi 90	66		02.99	08.00					
	1.4 HDi 70	50		01.03			BA2214		23599 19,0 /S	BOS
	1.4 i	55		09.00						
	1.6 16V	80		09.00						
	1.9 D	51		09.00						
	2.0 HDi 90	66		09.00						
	2.0 16V	100	ORGA 09184	09.00			BA2016		21674 19,3 /WK/S	LUC
	2.0 16V	120		04.97	08.00					
	2.0 HDi 110	80	ORGA 09184	05.01						
	2.0 16V	100	ORGA 09185		03.05		BA2229		23600 19,0 /S	BOS
	2.0 HDi 110	80	ORGA 09185		03.05					
	1.4 i	55		04.97	08.00	- ABS	BAR13185		247 13,0 11,0	
	1.5 D	42		04.97	08.00	- ABS				
	1.4 i	55		04.97	08.00	+ ABS	BAR20132		247 20,4 18,5 V	
	1.5 D	42		04.97	08.00	+ ABS				
	1.6 i	65		04.97	08.00					
	1.8 D	43		04.97	08.00					
	1.8 i	66		04.97	08.00					
	1.8 i	74		04.97	08.00	- (BR)				
	1.8 TD	66		10.97	08.00					
	1.9 D	50		04.97	08.00					
	1.9 D	51		07.98	08.00					
	1.9 SD	55		01.98	08.00					
	1.9 TD	66		04.97	08.00					
	1.8 16V	81		04.97	08.00		BAR20133		266 20,5 18,5 V	
	1.8 i	74		04.97	08.00	+ (BR)				
	2.0 16V	97		07.98	08.00					
	2.0 HDi 90	66		02.99	08.00					
	1.4 HDi 70	50		01.03	03.05		BAR22194		266 22,0 20,0 V	
	1.4 i	55		09.00	03.05					
	1.6 16V	80		09.00	03.05					
	1.9 D	51		09.00	03.05					
	2.0 HDi 90	66		09.00	03.05					
	2.0 16V	100	ORGA 09185		03.05		BAR26120		283 26,0 24,0 V	
	2.0 HDi 110	80	ORGA 09185		03.05					
	1.6 16V	80		09.00	03.05		BA2076		20973 11,0 +	BDX
	1.8 16V	81		04.97	08.00					
	1.8 i	74		04.97	08.00	+ (BR)				
	2.0 16V	97		07.98	08.00					
	2.0 16V	100		09.00	03.05					
	2.0 16V	120		04.97	08.00					
	2.0 HDi 110	80		05.01	03.05					
	2.0 HDi 90	66		02.99	03.05					
	1.6 16V	80		09.00	03.05		BAR08106		247 8,0 6,0	
	1.8 16V	81		04.97	08.00					
	1.8 i	74		04.97	08.00	+ (BR)				
	2.0 16V	97		07.98	08.00					
	2.0 16V	100		09.00	03.05					
	2.0 16V	120		04.97	08.00					
	2.0 HDi 110	80		05.01	03.05					
	2.0 HDi 90	66		02.99	03.05					
	1.4 i	55	ORGA 08210	04.97		+ ABS	BAW2001		Rz 20,64	LUC
	1.5 D	42	ORGA 08210	04.97		+ ABS				
	1.6 i	65	ORGA 08210	04.97		+ ABS				
	1.8 D	43	ORGA 08210	04.97		+ ABS				
	1.8 i	66	ORGA 08210	04.97		+ ABS				
	1.8 i	74		04.97	08.00	+ ABS				
	1.8 TD	66	ORGA 08210	10.97		+ ABS				
	1.9 D	50	ORGA 08210	04.97		+ ABS				
	1.9 D	51	ORGA 08210	07.98		+ ABS				

										
<b>CITROEN XSARA (N1) Limousine (97-05)</b>										
	1.9 SD	55	ORGA 08210	01.98			BAW2001		Rz 20,64	LUC
	1.9 TD	66	ORGA 08210	04.97		+ ABS				
	1.9 TD	66		04.97	08.00	- ABS				
	1.4 i	55	ORGA 08728	09.00			BAW2001		Rz 20,64	LUC
	1.9 D	51	ORGA 08728	09.00						
	1.4 HDi 70	50		01.03	03.05		BAE5002		203 x 38 HEB	LUC
	1.4 i	55		04.97	08.00	+ ABS				
	1.4 i	55		09.00	03.05					
	1.5 D	42		04.97	08.00	+ ABS				
	1.6 i	65		04.97	08.00	+ ABS				
	1.8 D	43		04.97	08.00	+ ABS				
	1.8 i	66		04.97	08.00	+ ABS				
	1.8 i	74		04.97	08.00	+ ABS/ - 				
	1.8 TD	66		10.97	08.00	+ ABS				
	1.9 D	50		04.97	08.00	+ ABS				
	1.9 D	51		07.98	08.00	+ ABS				
	1.9 D	51		09.00	03.05					
	1.9 SD	55		01.98	08.00					
1.9 TD	66		04.97	08.00						
<b>CITROEN XSARA (N2) Kombi (97-05)</b>										
	1.4 i	55		10.97	08.00	- ABS	BA2151		21827 17,3 +	ATE
	1.5 D	42		10.97	08.00	- ABS				
	1.6 i	65		10.97	08.00	- ABS				
	1.8 D	43		10.97	08.00	- ABS				
	1.9 D	50		10.97	08.00	- ABS				
	1.9 D	51		07.98	08.00	- ABS				
	1.4 i	55		10.97	08.00	+ ABS	BA2021		23124 19,0 +/WK/S	LUC
	1.5 D	42		10.97	08.00	+ ABS				
	1.6 i	65		10.97	08.00	+ ABS				
	1.8 16V	81		10.97	08.00					
1.8 D	43		10.97	08.00	+ ABS					
1.8 i	66		10.97	08.00						
1.8 i	74		10.97	08.00						
1.9 D	50		10.97	08.00	+ ABS					
1.9 D	51		07.98	08.00	+ ABS					
1.9 SD	55		01.98	08.00						
1.9 TD	66		10.97	08.00						
2.0 16V	97		07.98	08.00						
2.0 HDi 90	66		09.98	08.00						
1.4 HDi 70	50		01.03	08.05		BA2214		23599 19,0 /S	BOS	
1.4 i	55		09.00	08.05						
1.6 16V	80		09.00	08.05						
1.9 D	51		09.00	08.05						
2.0 HDi 90	66		09.00	08.05						
2.0 16V	100	ORGA 09184	09.00			BA2016		21674 19,3 /WK/S	LUC	
2.0 HDi 110	80	ORGA 09184	05.01							
2.0 16V	100	ORGA 09185		08.05		BA2229		23600 19,0 /S	BOS	
2.0 HDi 110	80	ORGA 09185		08.05						
	1.4 i	55		10.97	08.00	- ABS	BAR20132 BAR24127		247 20,4 18,5 V 280 24,0 21,9 V	
	1.5 D	42		10.97	08.00	- ABS				
	1.6 i	65		10.97	08.00	- ABS				
	1.8 D	43		10.97	08.00	- ABS				
	1.9 D	50		10.97	08.00	- ABS				
	1.9 D	51		07.98	08.00	- ABS				
	1.4 i	55		10.97	08.00	+ ABS	BAR20133		266 20,5 18,5 V	
	1.5 D	42		10.97	08.00	+ ABS				
	1.6 i	65		10.97	08.00	+ ABS				
	1.8 16V	81		10.97	08.00					
	1.8 D	43		10.97	08.00	+ ABS				
	1.8 i	66		10.97	08.00					
	1.8 i	74		10.97	08.00					
1.9 D	50		10.97	08.00	+ ABS					
1.9 D	51		07.98	08.00	+ ABS					
1.9 SD	55		01.98	08.00						
1.9 TD	66		10.97	08.00						
2.0 16V	97		07.98	08.00						
2.0 HDi 90	66		09.98	08.00						
1.4 HDi 70	50		01.03	08.05		BAR22194		266 22,0 20,0 V		
1.4 i	55		09.00	08.05						
1.6 16V	80		09.00	08.05						
1.9 D	51		09.00	08.05						
2.0 HDi 90	66		09.00	08.05						
2.0 16V	100	ORGA 09185		08.05		BAR26120		283 26,0 24,0 V		
2.0 HDi 110	80	ORGA 09185		08.05						
	1.6 16V	80		09.00	08.05		BAR08106		247 8,0 6,0	
	1.8 16V	81		10.97	08.00					
	1.8 i	74		10.97	08.00	+ 				
	2.0 16V	97		07.98	08.00					
	2.0 16V	100		09.00	08.05					
	2.0 HDi 110	80		05.01	08.05					
2.0 HDi 90	66		09.98	08.05						



















										
<b>CITROEN XSARA (N0) Coupe (97-05)</b>										
	1.4 i	55		02.98	08.00	- ABS	BA2090		21980 18,0 +/WE/S	BOS
	1.4 i	55		02.98	08.00	+ ABS	BA2151		21827 17,3 +	ATE
	1.6 i	65		02.98	08.00					
	1.8 i	66		02.98	08.00					
	1.8 i	74		04.97	08.00	- (BR)				
	1.9 D	50		02.98	08.00					
	1.9 D	51		02.98	08.00					
	1.9 TD	66		02.98	08.00					
	1.8 16V	81		02.98	08.00		BA2021		23124 19,0 +/WK/S	LUC
	1.8 i	74		04.97	08.00	+ (BR)				
	2.0 HDi 90	66		02.99	08.00					
	1.4 HDi 70	50		01.03	03.05		BA2214		23599 19,0 /S	BOS
	1.4 i	55		09.00	03.05					
	1.6 16V	80		09.00	03.05					
	1.9 D	51		09.00	03.05					
	2.0 HDi 90	66		09.00	03.05					
2.0	97	ORGA 09184	08.98			BA2016		21674 19,3 /WK/S	LUC	
2.0 16V	100	ORGA 09184	09.00							
2.0 16V	120	ORGA 09184	02.98							
2.0 HDi 110	80	ORGA 09184	05.01							
2.0	97	ORGA 09185		08.00		BA2229		23600 19,0 /S	BOS	
2.0 16V	100	ORGA 09185		03.05						
2.0 16V	120	ORGA 09185		03.05						
2.0 HDi 110	80	ORGA 09185		03.05						
	1.4 i	55		02.98	08.00	- ABS	BAR13185		247 13,0 11,0	
	1.4 i	55		02.98	08.00	+ ABS	BAR20132		247 20,4 18,5 V	
	1.6 i	65		02.98	08.00					
	1.8 i	66		02.98	08.00					
	1.8 i	74		04.97	08.00	- (BR)				
	1.9 D	50		02.98	08.00					
	1.9 D	51		02.98	08.00					
	1.9 TD	66		02.98	08.00					
	1.8 16V	81		02.98	08.00		BAR20133		266 20,5 18,5 V	
	1.8 i	74		04.97	08.00	+ (BR)				
	2.0 HDi 90	66		02.99	08.00					
	1.4 HDi 70	50		01.03			BAR22194		266 22,0 20,0 V	
	1.4 i	55		09.00						
	1.6 16V	80		09.00						
	1.9 D	51		09.00						
	2.0 HDi 90	66		09.00						
2.0	97	ORGA 09185		08.00		BAR26120		283 26,0 24,0 V		
2.0 16V	100	ORGA 09185		03.05						
2.0 16V	120	ORGA 09185		03.05						
2.0 HDi 110	80	ORGA 09185		03.05						
	1.6 16V	80		09.00	03.05		BA2076		20973 11,0 +	BDX
	1.8 16V	81		02.98	08.00					
	1.8 i	74		04.97	08.00	+ (BR)				
	2.0	97		08.98	08.00					
	2.0 16V	100		09.00	03.05					
	2.0 16V	120		02.98	03.05					
	2.0 HDi 110	80		05.01	03.05					
	2.0 HDi 90	66		02.99	03.05					
	1.6 16V	80		09.00	03.05		BAR08106		247 8,0 6,0	
	1.8 16V	81		02.98	08.00					
1.8 i	74		04.97	08.00	+ (BR)					
2.0	97		08.98	08.00						
2.0 16V	100		09.00	03.05						
2.0 16V	120		02.98	03.05						
2.0 HDi 110	80		05.01	03.05						
2.0 HDi 90	66		02.99	03.05						
	1.4 i	55	ORGA 08210	02.98		+ ABS	BAW2001		Rz 20,64	LUC
	1.6 i	65	ORGA 08210	02.98		+ ABS				
	1.8 i	66	ORGA 08210	02.98		+ ABS				
	1.8 i	74		04.97	08.00	+ ABS				
	1.9 TD	66	ORGA 08210	02.98		+ ABS				
	1.9 TD	66		02.98	08.00	- ABS				
	1.4 i	55	ORGA 08728	09.00			BAW2001		Rz 20,64	LUC
	1.9 D	51	ORGA 08728	09.00						
	1.4 HDi 70	50		01.03	03.05		BAE5002		203 x 38 HEB	LUC
	1.4 i	55		02.98	08.00	+ ABS				
1.4 i	55		09.00	03.05						
1.6 i	65		02.98	08.00	+ ABS					
1.8 i	66		02.98	08.00	+ ABS					
1.8 i	74		04.97	08.00	+ ABS/ - (BR)					
1.9 D	50		02.98	08.00	+ ABS					
1.9 D	51		02.99	08.00	+ ABS					
1.9 D	51		09.00	03.05						
1.9 TD	66		02.98	08.00						
<b>CITROEN XSARA Picasso (N68) (00-10)</b>										
	1.6	65		06.00	03.10	- ESP	BA2214		23599 19,0 /S	BOS
	1.6	67		06.02	03.10	- ESP				
	1.6	70		09.00	03.10	- ESP				
	1.6 16V	80		09.05	03.10	- ESP				
	1.6 HDi 110	80		05.04	03.10	- ESP				

CITROEN XSARA Picasso (N68) (00-10)										
	1.6 HDi 90	66		09.05	03.10	- ESP	BA2214		23599 19,0 /S	BOS
	1.8 16V	85		02.00	03.10	- ESP				
	2.0 16V	100		01.03	03.10	- ESP/ + Schaltgetriebe <sup>1)</sup>				
	2.0 HDi			06.00	03.10	- ESP				
	1.6	65		06.00	03.10	+ ESP				
	1.6	67		06.02	03.10	+ ESP				
	1.6	70		09.00	03.10	+ ESP				
	1.6 16V	80		09.05	03.10	+ ESP				
	1.6 HDi 110	80		05.04	03.10	+ ESP				
	1.6 HDi 90	66		09.05	03.10	+ ESP				
1.8 16V	85		02.00	03.10	+ ESP					
2.0 16V	100		01.03	03.10	+ Automatikgetriebe <sup>2)</sup>					
2.0 16V	100		01.03	03.10	+ ESP/ + Schaltgetriebe <sup>3)</sup>					
2.0 HDi			06.00	03.10	+ ESP					
	1.6	65		06.00	03.10		BAR20133	nur für Lucas-Sättel <sup>4)</sup>	266 20,5 18,5 V	
	1.6	67		06.02	03.10					
	1.6	70		09.00	03.10					
	1.6 16V	80		09.05	03.10					
	1.6 HDi 110	80		05.04	03.10					
	1.6 HDi 90	66		09.05	03.10					
	1.8 16V	85		02.00	03.10					
	2.0 16V			01.03	03.10					
	2.0 HDi			06.00	03.10					
	1.6	65		06.00	03.10	- ESP				
1.6	67		06.02	03.10	- ESP					
1.6	70		09.00	03.10	- ESP					
1.6 16V	80		09.05	03.10	- ESP					
1.6 HDi 110	80		05.04	03.10	- ESP					
1.6 HDi 90	66		09.05	03.10	- ESP					
1.8 16V	85		02.00	03.10	- ESP					
2.0 16V	100		01.03	03.10	- ESP/ + Schaltgetriebe <sup>1)</sup>					
2.0 HDi			06.00	03.10	- ESP					
1.6	65		06.00	03.10	+ ESP	BAR26120		283 26,0 24,0 V		
1.6	67		06.02	03.10	+ ESP					
1.6	70		09.00	03.10	+ ESP					
1.6 16V	80		09.05	03.10	+ ESP					
1.6 HDi 110	80		05.04	03.10	+ ESP					
1.6 HDi 90	66		09.05	03.10	+ ESP					
1.8 16V	85		02.00	03.10	+ ESP					
2.0 16V	100		01.03	03.10	+ Automatikgetriebe <sup>2)</sup>					
2.0 16V	100		01.03	03.10	+ ESP/ + Schaltgetriebe <sup>3)</sup>					
2.0 HDi			06.00	03.10	+ ESP					
	1.6 16V	80		09.05	03.10		BA2017		20961 17,2 /S	LUC
	1.6 HDi 110	80		05.04	03.10					
	1.6 HDi 90	66		09.05	03.10					
	1.8 16V	85 ORGA 09492			03.10	+ ESP				
	2.0 16V	100 ORGA 09821			03.10					
	2.0 HDi	ORGA 09492			03.10	+ ESP				
	1.6 16V	80		09.05	03.10		BAR09137		247 9,0 8,0	
	1.6 HDi 110	80		05.04	03.10					
	1.6 HDi 90	66		09.05	03.10					
	1.8 16V	85 ORGA 09492			03.10	+ ESP				
	2.0 16V	100 ORGA 09821			03.10					
	2.0 HDi	ORGA 09492			03.10	+ ESP				
	1.6	65		06.00	03.10		BAW2205		Rz 22,20	LUC
	1.6	67		06.02	03.10					
	1.6	70		09.00	03.10					
	1.8 16V	85		02.00	03.10					
	1.8 16V	85 ORGA 09492			03.10	- ESP				
	2.0 HDi	ORGA 09492	ORGA 09491	06.00	03.10	- ESP				
	1.6	65		06.00	03.10		BAE5019		229 x 42 HEB	LUC
	1.6	67		06.02	03.10					
	1.6	70		09.00	03.10					
	1.8 16V	85		02.00	03.10					
	1.8 16V	85 ORGA 09492			03.10	- ESP				
	2.0 HDi	ORGA 09492	ORGA 09491	06.00	03.10	- ESP				



























### CITROEN ZX (N2) Limousine (91-97)

	1.1	40		03.91	08.93		BA2074		20905 18,0 +/-WK	BDX				
	1.1	44		03.91	06.97									
	1.4	55		03.91	06.97									
	1.4 i	55		03.91	06.97									
	1.6 i	65		03.91	06.97									
	1.9 TD	66		07.92	06.97									
	1.6 i	65		03.91	06.97						BA2048		21460 18,2 /WK/S	LUC
	1.8 16V	81		01.96	06.97									
	1.8 i	74		07.92	06.97									
	1.9 i	88		03.91	06.97									
1.9 TD	66		07.92	06.97										
2.0 i	89		07.92	06.97										
1.8 D	44		06.93	06.97		BA2074		20905 18,0 +/-WK	BDX					
1.9 D	47		03.91	06.97										
1.9 D	50		06.94	06.97										
1.8 D	44		ORGA 06049	06.93		BA2020		21614 17,5 +/-WK	LUC					
1.9 D	47		ORGA 06049	03.91										





















<sup>1)</sup> - ESP/ + manual transm. / - ESP/+ scatola cambio velocità / - ESP/ + transmission mécanique / - ESP/ + cambio de velocidad  
<sup>2)</sup> + autom.transmission / + scatola cambio automatico / + transmission automatique / + cambio automático  
<sup>3)</sup> + ESP/ + manual transm. / + ESP/+ scatola cambio velocità / + ESP/ + transmission mécanique / + ESP/ + cambio de velocidad  
<sup>4)</sup> only for Lucas calipers / solo per pinze Lucas / seulement pour étriers Lucas / solo para pinzas Lucas

													
<b>CITROEN ZX (N2) Limousine (91-97)</b>													
	2.0 2.0 16V	122 120		09.96 05.96	10.97 06.97		BA2016	21674 19,3 /WK/S LUC					
	1.1 1.1 1.4 1.4 i 1.9 TD	40 44 55 55 66		03.91 03.91 03.91 03.91 07.92	08.93 06.97 06.97 06.97 06.97		BAR10187	247 10,0 8,0					
	1.6 i 1.8 16V 1.8 i 1.9 i 1.9 TD 2.0 i	65 81 74 88 66 89		03.91 01.96 07.92 03.91 07.92 07.92	06.97 06.97 06.97 06.97 06.97 06.97		BAR20132	247 20,4 18,5 V					
	1.8 D 1.9 D 1.9 D	44 47 50		06.93 03.91 06.94	06.97 06.97 06.97		BAR10187	247 10,0 8,0					
	2.0 2.0 16V	122 112		09.96 07.92	10.97 10.94		BAR20133	266 20,5 18,5 V					
		2.0 2.0 16V 2.0 16V 2.0 16V	122 110 112 120		09.96 06.94 07.92 05.96	10.97 06.97 10.94 06.97		BA2076	20973 11,0 + BDX				
			1.6 i 1.8 16V 1.8 D 1.8 i 1.9 D 1.9 D 1.9 i 1.9 TD 2.0 2.0 16V 2.0 16V 2.0 16V 2.0 i	65 81 44 74 47 50 88 66 122 110 112 120 89		03.91 01.96 06.93 07.92 03.91 06.94 03.91 07.92 09.96 06.94 07.92 05.96 07.92	06.97 06.97 06.97 06.97 06.97 06.97 06.97 06.97 10.97 06.97 10.94 06.97 06.97		BAR08106	247 8,0 6,0			
				1.1 1.4 1.4 i 1.6 i 1.8 16V 1.8 D 1.8 i 1.9 D 1.9 D 1.9 TD	44 ORGA 06749 55 ORGA 06749 55 ORGA 06749 65 ORGA 06749 81 44 ORGA 06749 74 ORGA 06749 47 ORGA 06749 50 ORGA 06749 66 ORGA 06749		01.96	06.97 + ABS 06.97 + ABS 06.97 + ABS 06.97 + ABS 06.97 + ABS 06.97 + ABS 06.97 + ABS 06.97 + ABS 06.97 + ABS		BAW2001	Rz 20,64 LUC		
					1.1 1.4 1.4 i 1.6 i 1.8 16V 1.8 D 1.8 i 1.9 D 1.9 D 1.9 TD	44 ORGA 06749 55 ORGA 06749 55 ORGA 06749 65 ORGA 06749 81 44 ORGA 06749 74 ORGA 06749 47 ORGA 06749 50 ORGA 06749 66 ORGA 06749		01.96	06.97 + ABS 06.97 + ABS 06.97 + ABS 06.97 + ABS 06.97 + ABS 06.97 + ABS 06.97 + ABS 06.97 + ABS 06.97 + ABS		BAE5002	203 x 38 HEB LUC	
	<b>CITROEN ZX (N2) Kombi (93-98)</b>												
					1.4 i 1.6 i	55 65		10.93 10.93	10.97 10.97		BA2074	20905 18,0 +/-WK BDX	
						1.6 i 1.8 16V 1.8 D 1.8 i 1.9 D 1.9 D 1.9 TD	65 81 44 74 47 50 66		10.93 01.96 10.93 10.93 10.93 06.94 10.93	10.97 02.98 10.97 10.97 10.97 10.97 10.97		BA2048	21460 18,2 /WK/S LUC
						1.4 i 1.6 i 1.8 16V 1.8 D 1.8 i 1.9 D 1.9 D 1.9 TD	55 65 81 44 74 47 50 66		10.93 10.93 01.96 10.93 10.93 06.94 10.93	10.97 10.97 02.98 10.97 10.97 10.97 10.97		BAR10187 BAR20132	247 10,0 8,0 247 20,4 18,5 V
						1.6 i 1.8 16V 1.8 D 1.8 i 1.9 D 1.9 D 1.9 TD	65 81 44 74 47 50 66		10.93 01.96 10.93 10.93 10.93 06.94 10.93	10.97 02.98 10.97 10.97 10.97 10.97 10.97		BAR08106	247 8,0 6,0



								
<b>Classic NFZ STEYR DAIMLER PUCH CITY-BUS (82-92)</b>								
	City Bus		01.82	12.92		BA2185		20588 16,5 /WE ATE
<b>Classic PKW ALFA ROMEO ALFASUD (71-84)</b>								
	1.2 1.3 1.5 TI		04.71 04.71 04.71	09.84 09.84 09.84		BAH0004	2	L=280
<b>Classic PKW ALFA ROMEO AR 6 (85-89)</b>								
	10 10 Bus 51 13 14 14 Turbo		04.85 04.85 04.85 03.86 09.86	12.89 12.89 12.89 12.89 12.89		BA2024		20741 19,2 +/-WK/S LUC
	10 10 Bus 51 13 14 14 Turbo		04.85 04.85 04.85 03.86 09.86	12.89 12.89 12.89 12.89 12.89		BAR16105		256 16,1 13,5
	10 10 Bus 51 13 14 14 Turbo		04.85 04.85 04.85 03.86 09.86	12.89 12.89 12.89 12.89 12.89		BAW2501		Rz 25,40 LUC
<b>Classic PKW ALFA ROMEO SPRINT (76-89)</b>								
	1.3 1.5		09.76 05.78	07.85 07.85		BAH0004	2	L=280
<b>Classic PKW AUDI 50 (74-78)</b>								
	0.8 1.1 1.3		01.76 08.74 08.77	07.78 07.78 07.78		BAH0008	2	L=290
	0.8 1.1 1.3		01.76 08.74 08.77	07.78 07.78 07.78		BAH0015	2	L=180
	0.8 1.1 1.3		01.76 08.74 08.77	07.78 07.78 07.78	- Bremskraftregler <sup>1)</sup> - Bremskraftregler <sup>1)</sup> - Bremskraftregler <sup>1)</sup>	BAW1401	+ GG <sup>2)</sup>	Rz 14,29
<b>Classic PKW AUDI 80 (72-78)</b>								
	1.3 1.5 1.6 Limousine 55 1.6 Limousine 63		01.72 05.72 09.75 09.75	07.76 08.75 + Schaltgetriebe <sup>3)</sup> 07.76 + Schaltgetriebe <sup>3)</sup> 07.76 + Schaltgetriebe <sup>3)</sup>		BAR10151		239 9,9 8,0
	1.3 1.5 1.6 55 1.6 55 1.6 61 1.6 63 1.6 63 1.6 Avant 55 1.6 Avant 63 1.6 81		08.76 05.72 09.75 08.76 09.73 09.75 08.76 01.75 01.75 09.73	08.78 08.75 + Automatikgetriebe <sup>4)</sup> 07.76 + Automatikgetriebe <sup>4)</sup> 08.78 08.78 07.76 + Automatikgetriebe <sup>4)</sup> 08.78 08.78 + S <sup>5)</sup> ABS 08.78 + S <sup>5)</sup> ABS 08.78		BAR12106		239 12,0 10,0
	1.3 1.5 1.6		01.72 05.72 09.73	08.78 08.75 08.78		BAR20123		239 20,0 18,0 V L
	1.3 1.5 1.6		01.72 05.72 09.73	08.78 08.75 08.78		BAH0010	2	L=310
	1.3 1.5 1.6 Limousine 55		08.74 08.74 09.75	08.78 08.75 + Schaltgetriebe <sup>3)</sup> 08.78 + Schaltgetriebe <sup>3)</sup>		BAH0015	2	L=180
	1.3 1.5 1.6 55 1.6 63 1.6 61 84-52040210 1.6 63 1.6 81 84-52040210 1.6 Avant 55 1.6 Avant 63		08.74 08.74 09.75 08.74 08.74 09.75 08.78 09.75 08.78 01.75 01.75	08.78 08.75 + Schaltgetriebe <sup>3)</sup> 08.78 + Schaltgetriebe <sup>3)</sup> 08.75 + Automatikgetriebe <sup>4)</sup> 08.75 + Schaltgetriebe <sup>3)</sup> 08.78 + Automatikgetriebe <sup>4)</sup> 08.78 08.78 + Schaltgetriebe <sup>3)</sup> 08.78 08.78 + S <sup>5)</sup> ABS 08.78 + S <sup>5)</sup> ABS		BAW1401	+ GG <sup>2)</sup>	Rz 14,29
	1.5 1.5 1.6 55 1.6 63 1.6 61 84-52040210 1.6 63 1.6 81 84-52040210 1.6 Avant 55 1.6 Avant 63		08.74 08.74 09.75 08.74 08.74 09.75 08.78 09.75 08.78 01.75 01.75	08.75 + Automatikgetriebe <sup>4)</sup> 08.75 + Schaltgetriebe <sup>3)</sup> 08.78 + Automatikgetriebe <sup>4)</sup> 08.78 08.78 + Schaltgetriebe <sup>3)</sup> 08.78 08.78 08.78 + S <sup>5)</sup> ABS 08.78 + S <sup>5)</sup> ABS		BAW1701	+ GG <sup>2)</sup>	Rz 17,46
<b>Classic PKW AUDI 80 (79-81)</b>								
	1.3 1.6 1.6 D 1.7 2.2		09.78 09.78 08.80 08.80 10.80	07.81 07.81 07.81 07.81 07.81		BAR10151		239 9,9 8,0
	1.6 1.6 D 1.7 2.2		09.78 08.80 08.80 10.80	07.81 07.81 07.81 07.81		BAR12106		239 12,0 10,0

1) - brake pressure regulator / - correttore di frenata / - correcteur de freinage / - corrector de frenado  
2) + cast iron / + ghisa / + fonte grise / + fundición de gris  
3) + manual transmission / + scatola cambio velocità / + transmission mécanique / + cambio de velocidad  
4) + autom.transmission / + scatola cambio automatico / + transmission automatique / + cambio automático

									
<b>Classic PKW AUDI 80 (79-81)</b>									
	1.3 1.6 1.6 D 1.7 2.2			09.78 09.78 08.80 08.80 10.80	07.81 07.81 07.81 07.81 07.81		BAH0010	2	L=310
	1.3 1.6 1.6 D 1.7 2.2		81-A0190513 81-A0190513 81-A0190513 81-A0190513 81-A0190513	09.78 09.78 08.80 08.80 10.80			BAH0011	2	L=160
	1.3 1.6 1.6 D 1.7 2.2	81-A0190514 81-A0190514 81-A0190514 81-A0190514 81-A0190514			07.81 07.81 07.81 07.81 07.81		BAH0011	2	L=160
	1.3 1.6 1.6 D 1.7 2.2			09.78 09.78 08.80 08.80 10.80	07.81 07.81 07.81 07.81 07.81		BAW1401	+ GG <sup>2)</sup>	Rz 14,29
	1.3 1.6 1.6 D 1.7 2.2		81-A0046050 81-A0046050 81-A0046050 81-A0046050 81-A0046050	09.78 09.78 08.80 08.80 10.80		+ Bremskraftregler <sup>3)</sup> + Bremskraftregler <sup>3)</sup> + Bremskraftregler <sup>3)</sup> + Bremskraftregler <sup>3)</sup> + Bremskraftregler <sup>3)</sup>	BAW1701	+ GG <sup>2)</sup>	Rz 17,46
	1.3 1.6 1.6 D 1.7 2.2	81-A0046051 81-A0046051 81-A0046051 81-A0046051 81-A0046051			07.81 07.81 07.81 07.81 07.81	+ Bremskraftregler <sup>3)</sup> + Bremskraftregler <sup>3)</sup> + Bremskraftregler <sup>3)</sup> + Bremskraftregler <sup>3)</sup> + Bremskraftregler <sup>3)</sup>	BAW1501	+ GG <sup>2)</sup>	Rz 15,87
	1.3 1.6 1.6 D 1.7 2.2			09.78 09.78 08.80 08.80 10.80	07.81 07.81 07.81 07.81 07.81	- verstärkte Bremse <sup>4)</sup> - verstärkte Bremse <sup>4)</sup> - verstärkte Bremse <sup>4)</sup> - verstärkte Bremse <sup>4)</sup> - verstärkte Bremse <sup>4)</sup>	BAE5003		180 x 31 HEB
<b>Classic PKW AUDI 80 (82-84)</b>									
	1.3 1.6 1.6 D 1.6 TD 1.7 1.8 1.9 2.0 2.2			08.81 08.81 08.81 02.82 08.81 08.81 08.81 08.83 08.81	07.84 07.84 07.84 07.84 07.83 07.84 07.83 07.84 08.83		BAR12106		239 12,0 10,0
	1.3 1.6 1.6 D 1.6 TD 1.7 1.8 1.9 2.0 2.2			08.81 08.81 08.81 02.82 08.81 08.81 08.81 08.83 08.81	07.84 07.84 07.84 07.84 07.83 07.84 07.83 07.84 08.83		BAH0010	2	L=310
	1.3 1.6 1.6 D 1.6 TD 1.7 1.8 1.9 2.0 2.2			08.81 08.81 08.81 02.82 08.81 08.81 08.81 08.83 08.81	07.84 07.84 07.84 07.84 07.83 07.84 07.83 07.84 08.83		BAH0015	2	L=180
	1.3 1.6 1.6 D 1.6 TD 1.7 1.8 1.9 2.0 2.2			08.81 08.81 08.81 02.82 08.81 08.81 08.81 08.83 08.81	07.84 07.84 07.84 07.84 07.83 07.84 07.83 07.84 08.83	- verstärkte Bremse <sup>4)</sup> - verstärkte Bremse <sup>4)</sup> - verstärkte Bremse <sup>4)</sup> - verstärkte Bremse <sup>4)</sup> - verstärkte Bremse <sup>4)</sup> - verstärkte Bremse <sup>4)</sup> - verstärkte Bremse <sup>4)</sup> - verstärkte Bremse <sup>4)</sup> - verstärkte Bremse <sup>4)</sup>	BAW1401	+ GG <sup>2)</sup>	Rz 14,29
	1.3 1.6 1.6 D 1.6 TD 1.7 1.8 1.9 2.0 2.2			08.81 08.81 08.81 02.82 08.81 08.81 08.81 08.83 08.81	07.84 07.84 07.84 07.84 07.83 07.84 07.83 07.84 08.83	+ verstärkte Bremse <sup>5)</sup> + verstärkte Bremse <sup>5)</sup> + verstärkte Bremse <sup>5)</sup> + verstärkte Bremse <sup>5)</sup> + verstärkte Bremse <sup>5)</sup> + verstärkte Bremse <sup>5)</sup> + verstärkte Bremse <sup>5)</sup> + verstärkte Bremse <sup>5)</sup> + verstärkte Bremse <sup>5)</sup>	BAW1501	+ GG <sup>2)</sup>	Rz 15,87

1) - brake pressure regulator / - correttore di frenata / - correcteur de freinage / - corrector de frenado

2) + cast iron / + ghisa / + fonte grise / + fundición de gris

3) + brake pressure regulator / + correttore di frenata / + correcteur de freinage / + corrector de frenado





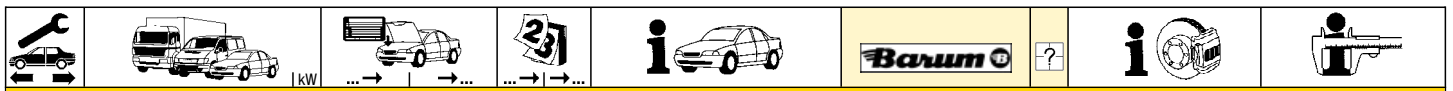























4) - heavy duty brake / - freno rinforzato / - frein renforcé / - freno reforzado

5) + heavy duty brake / + freno rinforzato / + frein renforcé / + freno reforzado



Classic PKW AUDI 80 (82-84)									
	1.3 1.6 1.6 D 1.6 TD 1.7 1.8 1.9 2.0 2.2			08.81 08.81 08.81 02.82 08.81 08.81 08.81 08.83 08.81	07.84 07.84 07.84 07.84 07.83 07.84 07.84 07.84 08.83	- verstärkte Bremse <sup>1)</sup> - verstärkte Bremse <sup>1)</sup> - verstärkte Bremse <sup>1)</sup> - verstärkte Bremse <sup>1)</sup> - verstärkte Bremse <sup>1)</sup> - verstärkte Bremse <sup>1)</sup> - verstärkte Bremse <sup>1)</sup> - verstärkte Bremse <sup>1)</sup> - verstärkte Bremse <sup>1)</sup>	BAE5003		180 x 31 HEB
Classic PKW AUDI 80 (84-87)									
	1.3 1.6 1.6 D 1.6 TD			06.84 06.84 06.84 06.84	03.87 03.87 03.87 03.87		BAR12106		239 12,0 10,0
	1.8 2.0			06.84 02.86	03.87 03.87		BAR20123		239 20,0 18,0 V L
	1.3 1.6 1.6 D 1.6 TD 1.8 2.0			06.84 06.84 06.84 06.84 06.84 02.86	03.87 03.87 03.87 03.87 03.87 03.87		BAH0010	2	L=310
	1.3 1.6 1.6 D 1.6 TD			06.84 06.84 06.84 06.84	03.87 03.87 03.87 03.87		BAW1401	+ GG <sup>2)</sup>	Rz 14,29
	1.8 2.0			06.84 02.86	03.87 03.87		BAW1501	+ GG <sup>2)</sup>	Rz 15,87
	1.3			06.84	03.87		BAE5003		180 x 31 HEB
Classic PKW AUDI 80 (87-91)									
	1.6 1.6 D 1.6 TD 1.8 1.9 D 1.9 E 2.0			09.86 02.87 04.88 09.86 08.89 09.86 08.88	07.91 07.89 07.91 07.91 07.91 07.88 07.91		BA2031		20669 19,6 / S LUC
	1.6 1.6 1.6 D 1.6 TD 1.6 TD 1.8 1.8 1.9 D			09.86 08.89 02.87 04.88 08.89 09.86 09.86 08.89	07.89 07.91 07.89 07.89 07.91 07.91 07.91 07.91	+ Schaltgetriebe <sup>3)</sup> - Taxi - Taxi/ + Schaltgetriebe <sup>4)</sup> + Schaltgetriebe <sup>3)</sup> + Schaltgetriebe <sup>3)</sup>	BAR13160		256 12,9 11,0
	1.8 1.8 1.8 1.9 E 2.0	55 66		09.86 04.88 08.89 09.86 09.86 08.88	07.91 07.91 07.91 07.91 07.91 07.91	+ Automatikgetriebe <sup>5)</sup> + Taxi + Automatikgetriebe <sup>5)</sup> + Automatikgetriebe <sup>5)</sup> + Automatikgetriebe <sup>5)</sup>	BAR22118		257 21,9 20,0 V
	1.6 1.6 D 1.6 TD 1.8 1.9 D 1.9 E 2.0			8A-L-038656 8A-L-038656 8A-L-038656 8A-L-038656 8A-L-038656	09.86 02.87 04.88 09.86 08.89 09.86 08.88		BAH0010	2	L=310
	1.6 1.6 TD 1.8 1.9 D 2.0	8A-L-038657 8A-L-038657 8A-L-038657 8A-L-038657 8A-L-038657			07.91 07.91 07.91 07.91 07.91		BAH0012 BAH0003	2 2	am Bremssattel <sup>6)</sup> L=285 L=160
	1.6 1.6 D 1.6 TD 1.8 1.8 1.8 1.9 D 1.9 E 2.0			09.86 02.87 04.88 09.86 09.86 09.86 08.89 09.86 08.88	07.91 07.89 07.91 07.91 07.91 07.91 07.91 07.88 07.91	+ ABS + ABS + ABS + ABS + ABS + ABS + ABS	BA2052		21144 16,6 / S LUC
	1.6 1.6 D 1.6 TD 1.8 1.8 1.8 1.9 D			09.86 02.87 04.88 09.86 09.86 09.86 08.89	07.91 07.89 07.91 07.91 07.91 07.91 07.91	+ ABS + ABS + ABS + ABS + ABS + ABS	BAR10178		245 9,9 8,0

1) - heavy duty brake / - freno rinforzato / - frein renforcé / - freno reforzado  
2) + cast iron / + ghisa / + fonte grise / + fundición de gris  
3) + manual transmission / + scatola cambio velocità / + transmission mécanique / + cambio de velocidad  
4) - Taxi/ + manual transm. / - Taxi/+ scatola cambio velocità / - Taxi/ + transmission mécanique / - Taxi/ + cambio de velocidad  
5) + autom.transmission / + scatola cambio automatico / + transmission automatique / + cambio automático  
6) on the brake caliper / sulla pinza freno / sur l'étrier de frein / a la pinza de freno

								
<b>Classic PKW AUDI 80 (87-91)</b>								
	1.9 E 2.0			09.86 07.88 08.88 07.91	BAR10178			245 9,9 8,0
	1.6 1.6 D 1.6 TD 1.8 1.9 D 1.9 E 2.0			09.86 07.91 02.87 07.89 04.88 07.91 09.86 07.91 08.89 07.91 09.86 07.88 08.88 07.91	BAH0003	2	am Bremssattel <sup>1)</sup>	L=160
	1.6 1.6 1.6 D 1.8	51 55		09.86 07.91 09.86 07.91 02.87 07.89 09.86 07.91	BAW1501		+ GG <sup>3)</sup>	Rz 15,87
	1.6 1.6 TD 1.8 1.8 1.9 D	51 55 66		09.86 07.91 04.88 07.91 09.86 07.91 09.86 07.91 08.89 07.91	BAW1905			Rz 19,05
	1.6 1.6 D 1.6 TD 1.8 1.8 1.9 D	89-K-200001 89-K-200001 89-K-200001 55 89-K-200001 66 89-K-200001	8A-M-080000 8A-M-080000 8A-M-080000 8A-M-080000 8A-M-080000	07.89 - ABS - ABS - ABS - ABS - ABS	BAE5001			200 x 40 HEB <b>VW</b>
<b>Classic PKW AUDI 80 Quattro (78-86)</b>								
	1.8 2.0 2.2			08.84 08.86 08.83 07.84 08.82 08.86	BA2178			20669 16,3 /S <b>LUC</b>
	1.8 2.0 2.2			08.84 08.86 08.83 07.84 08.82 08.86	BAH0010	2		L=310
	1.8 2.0 2.2			08.84 08.86 08.83 07.84 08.82 08.86	BA2052			21144 16,6 /S <b>LUC</b>
	2.2		85-D-250000	08.82	BAH0010	2		L=310
<b>Classic PKW AUDI 80 Quattro (87-91)</b>								
	1.8 1.9 E 2.0			09.86 09.91 09.86 07.88 08.88 09.91	BA2031			20669 19,6 /S <b>LUC</b>
	1.8 1.8 1.9 E 2.0	66 82		09.86 09.91 09.86 07.88 08.88 09.91	BAR13160 BAR22118			256 12,9 11,0 257 21,9 20,0 V
	1.8 1.9 E 2.0		8A-L-030000 8A-L-030000	09.86 09.86 08.88	BAH0010	2		L=310
	1.8 2.0	8A-L-030001 8A-L-030001		09.91 09.91	BAH0012 BAH0003	2 2	am Bremssattel <sup>1)</sup>	L=285 L=160
	1.8 1.9 E 2.0			09.86 09.91 09.86 07.88 08.88 09.91	BA2052			21144 16,6 /S <b>LUC</b>
<b>Classic PKW AUDI 90 (85-87)</b>								
	1.6 TD 2.0 2.2			10.84 03.87 10.84 03.87 10.84 03.87	BA2178			20669 16,3 /S <b>LUC</b>
	1.6 TD 2.0 2.2			10.84 03.87 10.84 03.87 10.84 03.87	BAH0010	2		L=310
	2.2	100		10.84 03.87	BA2052			21144 16,6 /S <b>LUC</b>
	2.2	100		10.84 03.87	BAR10178			245 9,9 8,0
	2.2	100		10.84 03.87	BAH0003	2		L=160
	1.6 TD 2.0 2.2	85		10.84 03.87 10.84 03.87 01.85 03.87	BAW1701		+ GG <sup>3)</sup>	Rz 17,46
<b>Classic PKW AUDI 90 (87-91)</b>								
	1.6 TD 1.8 2.0 2.2 2.3	100		04.88 07.91 08.89 07.91 04.87 07.91 04.87 07.91 04.87 07.91	BA2031			20669 19,6 /S <b>LUC</b>

<sup>1)</sup> on the brake caliper / sulla pinza freno / sur l'étrier de frein / a la pinza de freno



























<sup>2)</sup> - ABS/ - brake press.regulator / - ABS/ - correttore di frenata / - ABS/ - correcteur de freinage / - ABS/ - corrector de frenado

<sup>3)</sup> + cast iron / + ghisa / + fonte grise / + fundición de gris

<sup>4)</sup> - ABS/ + manual transmission / - ABS/+ scatola camb.velocità / - ABS/ + transmission mécanique / - ABS/ + cambio de velocidad



























<sup>5)</sup> - ABS/ + brake press.regulator / - ABS/ + correttore di frenata / - ABS/ + correcteur de freinage / - ABS/ + corrector de frenado

<sup>6)</sup> - ABS/ + autom.transmission / - ABS/ + scatola cambio autom. / - ABS/ + transmission automatique / - ABS/ + cambio automático

								
<b>Classic PKW AUDI 90 (87-91)</b>								
	1.8 2.0 2.2 2.3 100			08.89 04.87 04.87 04.87 04.88	07.91 07.91 07.91 07.91 07.91	BAR22118		257 21,9 20,0 V
	1.6 TD			04.88	07.91	BAR13160		256 12,9 11,0
	1.6 TD 1.8 2.0 2.2 2.3 100		8A-L-038656 8A-L-038656 8A-L-038656 8A-L-038656 8A-L-038656	04.88 08.89 04.87 04.87 04.87		BAH0010	2	L=310
	1.6 TD 1.8 2.0 2.2 2.3	8A-L-038657 8A-L-038657 8A-L-038657 8A-L-038657 8A-L-038657			07.91 07.91 07.91 07.91 07.91	BAH0012 BAH0003	2 2	am Bremssattel <sup>1)</sup> L=285 L=160
	1.6 TD 1.8 2.0 2.2 2.3			04.88 08.89 04.87 04.87 04.87	07.91 07.91 07.91 07.91 07.91	BA2052		21144 16,6 /S LUC
	1.6 TD 1.8 2.0 2.2 2.3			04.88 08.89 04.87 04.87 04.87	07.91 07.91 07.91 07.91 07.91	BAR10178		245 9,9 8,0
	1.6 TD 1.8 2.0 2.2 2.3			04.88 08.89 04.87 04.87 04.87	07.91 07.91 07.91 07.91 07.91	BAH0003	2	am Bremssattel <sup>1)</sup> L=160
	1.6 TD			04.88	07.91	BAW1905		Rz 19,05
	1.6 TD	89-K-200001	8A-M-080000			BAE5001		200 x 40 HEB VW
<b>Classic PKW AUDI 90 Quattro (84-87)</b>								
	2.2			08.84	03.87	BA2178		20669 16,3 /S LUC
	2.2			08.84	03.87	BAH0010	2	L=310
	2.2			08.84	03.87	BA2052		21144 16,6 /S LUC
<b>Classic PKW AUDI 90 Quattro (87-91)</b>								
	2.0 2.2 2.3 100			01.88 04.87 04.87	09.91 09.91 09.91	BA2031		20669 19,6 /S LUC
	2.0 2.2 2.3 100			01.88 04.87 04.87	09.91 09.91 09.91	BAR22118		257 21,9 20,0 V
	2.2 2.3 100		8A-L-030000 8A-L-030000	04.87 04.87		BAH0010	2	L=310
	2.0 2.2 2.3	8A-L-030001 8A-L-030001		01.88 09.91 09.91	09.91 09.91 09.91	BAH0012 BAH0003	2 2	am Bremssattel <sup>1)</sup> L=285 L=160
	2.0 2.2 2.3			01.88 04.87 04.87	09.91 09.91 09.91	BA2052		21144 16,6 /S LUC
<b>Classic PKW AUDI 100 Quattro (85-90)</b>								
	1.8 2.2 2.3		44-G-073362 44-G-073362	10.84 08.85 08.86	12.87	BA2028		20901 19,6 +WK/S LUC
	1.8 2.2 2.3			01.88 01.88 01.88	11.90 11.90 11.90	BA2028		20901 19,6 +WK/S LUC
	1.8 1.8 2.2 2.3			10.84 01.88 01.88 01.88	12.87 11.90 11.90 11.90	BAR22118 BAR22118		257 21,9 20,0 V 257 21,9 20,0 V
	1.8 1.8 2.2 2.3	44-G-200001 44-G-200001 44-G-200001 44-G-200001			11.90 12.87 12.87 12.87	BAH0010	2	L=310
	1.8 2.2 2.2 Turbo 2.3			10.84 10.84 03.86 08.86	11.90 11.90 11.90 11.90	BA2052		21144 16,6 /S LUC

<sup>1)</sup> on the brake caliper / sulla pinza freno / sur l'étrier de frein / a la pinza de freno

<sup>2)</sup> - reinforced suspension / - sospensione rinforzata / - châssis renforcé / - suspensión reforzada

								
<b>Classic PKW AUDI 100 (76-79)</b>								
	1.6 2.0 2.0 D 2.2 2.2	85	08.76 06.76 10.78 04.78 03.77	07.79 07.78 - belüftete Scheiben <sup>1)</sup> - belüftete Scheiben <sup>1)</sup> 07.79 + 	BAR13160			256 12,9 11,0
	2.0 D 2.2 2.2	100	10.78 08.78 03.77	07.79 + belüftete Scheiben <sup>2)</sup> + belüftete Scheiben <sup>2)</sup> 07.79	BAR22118			257 21,9 20,0 V
	1.6 2.0 2.0 D 2.2		08.76 06.76 10.78 06.76	07.79 07.79 07.79 07.79	BAH0015	2		L=180
	1.6 2.0 2.0 D 2.2		08.76 06.76 10.78 03.77	07.79 07.78 07.79 07.79	BAW1501 BAW1701	+ GG <sup>3)</sup> + GG <sup>3)</sup>		Rz 15,87 Rz 17,46
	2.2	100	03.77	07.79	BAE5006			230 x 40 HEB <b>VW</b>
<b>Classic PKW AUDI 100 (80-81)</b>								
	2.2	100	08.79	07.81	BA2031			20669 19,6 /S <b>LUC</b>
	1.6 1.9 2.0 D 2.2 2.2	85 100	08.79 08.80 08.79 08.79 08.79	07.81 07.81 07.81 07.81 07.81	BAR13160 BAR22118			256 12,9 11,0 257 21,9 20,0 V
	1.6 1.9 2.0 D 2.2		08.79 08.80 08.79 08.79	07.81 07.81 07.81 07.81	BAH0015	2		L=180
	1.6 1.9 2.0 D 2.2		08.79 08.80 08.79 08.79	07.81 07.81 07.81 07.81	BAW1501 BAW1701	+ GG <sup>3)</sup> + GG <sup>3)</sup>		Rz 15,87 Rz 17,46
	2.2	100	08.79	07.81	BAE5006			230 x 40 HEB <b>VW</b>
<b>Classic PKW AUDI 100 (82)</b>								
	1.9 2.0 D 2.0 TD 2.2		08.81 08.81 11.81 08.81	07.82 + belüftete Scheiben <sup>2)</sup> + belüftete Scheiben <sup>2)</sup> 07.82 + belüftete Scheiben <sup>2)</sup>	BA2031			20669 19,6 /S <b>LUC</b>
	1.6 1.9 2.0 D 2.2 1.9 2.0 D 2.0 TD 2.2		08.81 08.81 08.81 08.81 08.81 08.81 11.81 08.81	07.82 07.82 07.82 07.82 07.82 07.82 07.82 07.82	BAR13160 BAR22118			256 12,9 11,0 257 21,9 20,0 V
	1.6 1.9 2.0 D 2.0 TD 2.2		08.81 08.81 08.81 11.81 08.81	07.82 07.82 07.82 07.82 07.82	BAH0015	2		L=180
	1.6 1.9 2.0 D 2.0 TD 2.2		08.81 08.81 08.81 11.81 08.81	07.82 07.82 07.82 07.82 07.82	BAW1501 BAW1501 BAW1701	+ GG <sup>3)</sup> + ALU <sup>4)</sup> + GG <sup>3)</sup>		Rz 15,87 Rz 15,87 Rz 17,46
	1.9 2.0 D 2.0 TD 2.2 2.2	79 100	08.81 08.81 11.81 08.81 08.81	07.82 + belüftete Scheiben <sup>2)</sup> + belüftete Scheiben/ +  <sup>5)</sup> + belüftete Scheiben <sup>2)</sup> 07.82 +  07.82	BAE5006			230 x 40 HEB <b>VW</b>
<b>Classic PKW AUDI 100 (83-90)</b>								
	1.8 1.9 2.0 2.0 D 2.0 TD 2.2 2.2 2.2 CS 2.3 2.4 D	85 100 100	08.82 08.82 08.84 08.82 08.82 08.82 08.82 08.82 10.83 08.89	12.90 07.84 12.90 07.89 12.90 09.86 12.90 für 4-Loch-Felge <sup>6)</sup> 08.82 12.90 für 4-Loch-Felge <sup>6)</sup> 12.90	BA2028			20901 19,6 +/WK/S <b>LUC</b>

<sup>1)</sup> - ventilated discs / - dischi ventilati / - disques ventilés / - disco ventilado

<sup>2)</sup> + ventilated discs / + dischi ventilati / + disques ventilés / + disco ventilado

<sup>3)</sup> + cast iron / + ghisa / + fonte grise / + fundición de gris

<sup>4)</sup> + aluminium / + alluminio / + aluminium / + aluminio

<sup>5)</sup> + ventilated discs/ +  / + dischi ventilati/ +  / + disques ventilés/ +  / + disco ventilado/ + 

<sup>6)</sup> for 4 bore wheel rim / per cerchione a 4 fori / pour jante à 4 trous / para Llantas de 4 taladros

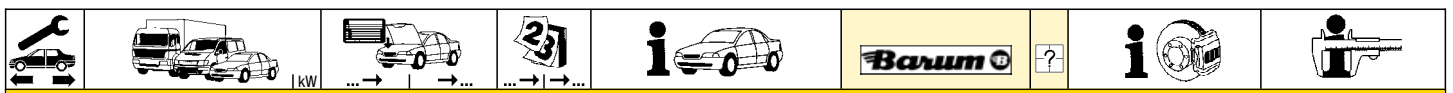































**Classic PKW AUDI 100 (83-90)**

	1.8 Limousine 1.9 Limousine 2.0 D Limousine 2.0 TD Limousine		08.82 08.82 08.82 08.82	12.90 07.84 07.84 07.84	BAR13160		256 12,9 11,0
	1.8 Avant 1.9 Avant 2.0 2.0 D 2.0 D Avant 2.0 TD 2.0 TD Avant 2.2 2.2 2.3 2.4 D		08.82 08.82 08.84 08.84 08.82 08.84 08.82 08.82 08.82 10.83 08.89	12.90 07.84 12.90 07.89 07.84 12.90 07.84 09.86 12.90 12.90 12.90	BAR22118		257 21,9 20,0 V
	1.8 2.0 2.0 D 2.0 TD 2.2 2.2 2.2 Turbo 2.3 2.4 D 2.5 TDI	44-G-200001 44-G-200001 44-G-200001 44-G-200001 85 44-G-200001 100 44-G-200001 44-G-200001	12.90 12.90 07.89 12.90 09.86 12.90 08.86 12.90 08.89 01.90	- verstärktes Fahrwerk <sup>2)</sup> - verstärktes Fahrwerk <sup>2)</sup> - verstärktes Fahrwerk <sup>2)</sup> - verstärktes Fahrwerk <sup>2)</sup> - verstärktes Fahrwerk <sup>2)</sup> - verstärktes Fahrwerk <sup>2)</sup> - verstärktes Fahrwerk <sup>2)</sup> - verstärktes Fahrwerk <sup>2)</sup> - verstärktes Fahrwerk <sup>2)</sup> - verstärktes Fahrwerk <sup>2)</sup>	BAH0010	2	L=310
	1.8 1.9 2.0 2.0 D 2.0 TD 2.2 2.2 2.2 Turbo 2.3 2.4 D 2.5 TDI		08.82 08.82 08.84 08.82 08.82 08.82 08.86 10.83 08.89 01.90	12.90 + ABS 07.84 + ABS 12.90 + ABS 07.89 + ABS 12.90 + ABS 09.86 + ABS 12.90 12.90 12.90 + ABS 12.90	BA2052		21144 16,6 /S LUC
	1.8 1.9 2.0 2.0 D 2.0 TD 2.2 2.2 2.3		08.82 08.82 08.84 08.82 08.82 08.82 08.82 10.83	12.87 + ABS 07.84 + ABS 12.87 + ABS 12.87 + ABS 12.87 + ABS 09.86 + ABS 12.87 12.87	BAR10178		245 9,9 8,0
	1.8 2.0 2.0 D 2.0 TD 2.2	44-G-073362 44-G-073362 44-G-073362 44-G-073362 44-G-073362	08.84 08.84 08.82 08.82 08.84	+ HA-Trommelbremse <sup>3)</sup> + HA-Trommelbremse <sup>3)</sup> + HA-Trommelbremse <sup>3)</sup> + HA-Trommelbremse <sup>3)</sup> + HA-Trommelbremse <sup>3)</sup>	BAH0015	2	L=180
	1.8 2.0 2.0 TD 2.4 D		08.89 08.89 08.89 08.89	+ HA-Trommelbremse <sup>3)</sup> + HA-Trommelbremse <sup>3)</sup> + HA-Trommelbremse <sup>3)</sup> + HA-Trommelbremse <sup>3)</sup>	BAH0015	2	L=180
	1.8 2.0 2.0 TD 2.2 2.2 Turbo 2.3 2.4 D 2.5 TDI		08.89 08.89 08.89 08.89 08.89 08.89 08.89 01.90	+ HA-Scheibenbremse <sup>4)</sup> + HA-Scheibenbremse <sup>4)</sup> + HA-Scheibenbremse <sup>4)</sup> + HA-Scheibenbremse <sup>4)</sup> + HA-Scheibenbremse <sup>4)</sup> + HA-Scheibenbremse <sup>4)</sup> + HA-Scheibenbremse <sup>4)</sup>	BAH0015	2	L=180
	1.8 1.9 2.0 2.0 D 2.0 TD 2.2 2.4 D		08.82 08.82 08.84 08.82 08.82 08.82 08.89	12.90 - ABS 07.84 - ABS 12.90 - ABS 07.89 - ABS 12.90 - ABS 09.86 - ABS 12.90 - ABS	BAW1701		Rz 17,46
	1.8 1.9 2.0 2.0 D 2.0 TD 2.2 2.4 D		08.82 08.82 08.84 08.82 08.82 08.82 08.89	12.90 - ABS 07.84 - ABS 12.90 - ABS 07.89 - ABS 12.90 - ABS 09.86 - ABS 12.90 - ABS	BAE5006		230 x 40 HEB VW

**Classic PKW AUDI 200 Quattro (85-91)**























	2.2	44-G-073362	11.84		BA2028		20901 19,6 +/-WK/S LUC
	2.2		11.84	11.90	BA2052		21144 16,6 /S LUC

1) for 4 bore wheel rim / per cerchione a 4 fori / pour jante à 4 trous / para Llantas de 4 taladros  
 2) - reinforced suspension / - sospensione rinforzata / - châssis renforcé / - suspensión reforzada  
 3) + RA drum brake / + P freno a tamburo / + frein à tambour essieu AR / + ET-tambores de freno  
 4) + RA disc brake / + P disco freno / + frein à disque essieu AR / + ET-disco de freno

								
<b>Classic PKW AUDI 200 (80-83)</b>								
	2.2			10.79	08.83		BA2031	20669 19,6 /S LUC
	2.2			10.79	08.83		BA2052	21144 16,6 /S LUC
	2.2			10.79	08.83		BAH0015 BAH0003	2 2 am Bremssattel <sup>1)</sup> L=180 L=160
<b>Classic PKW AUDI 200 (84-91)</b>								
	2.1 2.2		44-G-073362 08.83 44-G-073362 08.84				BA2028	20901 19,6 +/WK/S LUC
	2.1 2.2			08.83 08.84	01.88 12.90		BA2052	21144 16,6 /S LUC
	2.1 2.2		44-G-073363 44-G-073363		01.88 12.90		BAH0015	2 L=180
<b>Classic PKW AUDI COUPE (81-88)</b>								
	2.0 2.2 2.3	85-F-000001 85-F-000001		07.87 07.88 02.87	08.83 08.83 07.88		BA2178	20669 16,3 /S LUC
	1.6 1.8 1.9 2.0 2.2 2.2		85-E-220000 85-E-220000	02.81 08.81 10.80 09.83 02.81 02.81	08.81 08.83 08.83 08.83 08.83 + <sup>Ⓢ</sup> 08.83		BAR12106	239 12,0 10,0
	1.8 2.2	85-F-000001 96	85-E-220000	07.88 09.81	08.83		BAR20123	239 20,0 18,0 VL
	1.6 1.8 1.9 2.0 2.2 2.3			02.81 08.81 10.80 09.83 09.84 02.87	08.81 07.88 08.83 07.88 07.88 07.88		BAH0010	2 L=310
	2.2 2.3	100		09.84 02.87	07.88 07.88		BA2052	21144 16,6 /S LUC
	2.2 2.3	100		09.84 02.87	07.88 07.88		BAR10178	245 9,9 8,0
	1.6 1.8 1.9 2.0 2.2 2.2 2.3	85 96 100		02.81 08.81 10.80 09.83 09.84 09.84 02.87	08.81 07.88 08.83 07.88 07.88 07.88 07.88		BAH0015     BAH0003	2     2 L=180     L=160
	1.6 1.8		85-E-220000	02.81 08.81	08.81 08.81		BAW1401	+ GG <sup>3)</sup> Rz 14,29
	1.6 1.8 1.8 1.9	85-F-000001	85-E-220000	02.81 08.81 10.80	08.81 08.81 08.83		BAW1501	+ GG <sup>3)</sup> Rz 15,87
	2.0 2.2 2.2 2.2	77 85 96		09.83 02.81 02.81 02.81	07.87 07.84 + <sup>Ⓢ</sup> 07.88 07.84		BAW1701	+ GG <sup>3)</sup> Rz 17,46
	1.6 1.8		85-E-220000	02.81 08.81	08.81 08.81		BAE5003	+ Schaltgetriebe <sup>2)</sup> + Schaltgetriebe <sup>2)</sup> 180 x 31 HEB
<b>Classic PKW AUDI COUPE Quattro (85-87)</b>								
	2.2 2.3			12.84 01.87	12.87 12.87		BA2178	20669 16,3 /S LUC
	2.2 2.3			12.84 01.87	12.87 12.87		BAH0010	2 L=310
	2.2 2.3			12.84 01.87	12.87 12.87		BA2052	21144 16,6 /S LUC
<b>Classic PKW AUDI QUATTRO (80-91)</b>								
	2.2		85-C-902000	07.80			BA2031	20669 19,6 /S LUC
	2.2 2.2	119 85-D-900001 147 85-D-900001	85-G-902400 85-G-902400				BA2028	20901 19,6 +/WK/S LUC

1) on the brake caliper / sulla pinza freno / sur l'étrier de frein / a la pinza de freno  
2) + manual transmission / + scatola cambio velocità / + transmission mécanique / + cambio de velocidad  
3) + cast iron / + ghisa / + fonte grise / + fundición de gris  
4) + autom.transmission / + scatola cambio automatico / + transmission automatique / + cambio automático



								
<b>Classic PKW AUDI QUATTRO (80-91)</b>								
	2.2 2.2 2.2	119 147 162		08.84 07.80 07.80	07.89 07.91 07.91	BA2052		21144 16,6 /S LUC
	2.2		85-D-902500	07.80		BAH0010	2	L=310
<b>Classic PKW AUDI V8 (88-94)</b>								
	3.6 4.2			10.88 10.91	02.94 02.94	BA2052		21144 16,6 /S LUC
<b>Classic PKW AUTOBIANCHI A 111 (69-72)</b>								
	1.4			08.69	11.72	BA2062		20073 17,3 BDX
<b>Classic PKW AUTOBIANCHI A 112 (69-86)</b>								
	0.9 1.0 1.0 Abarth			10.69 11.77 09.71	12.85 12.85 12.84	BA2062		20073 17,3 BDX
	0.9 1.0 1.0 Abarth			11.82 11.82 11.82	12.85 12.84 12.84	BAW1902		Rz 19,05
<b>Classic PKW AUTOBIANCHI Y 10 (85-95)</b>								
	1.0 1.0 i.e. 1.1 i.e.			06.85 12.87 01.90	12.89 12.89 12.95	BA2065		20775 18,0 /WK BDX
	1.0 1.0 i.e. 1.1 i.e. 1.1 Turbo 1.3 GT i.e.			06.85 12.87 01.90 06.85 02.89	12.89 12.89 12.95 12.89 12.89	BAW1902		Rz 19,05
<b>Classic PKW BMW 3er Reihe/E21 (75-83)</b>								
	315 316 318 318 i 320 i 320/4 320/6			04.81 06.75 06.75 09.79 09.78 06.75 08.77	12.83 07.83 08.80 12.83 <sup>USA</sup> 07.79 10.82	BA2185 BAV1035	1	20588 16,5 /WE ATE Warnkontakt L=165mm
	320 i 323 i			10.75 01.78	07.78 10.82	BA2185 BAV1035	1	20588 16,5 /WE ATE Warnkontakt L=165mm
	323 i			01.78	10.82	BAV1035	1	Warnkontakt L=165mm
<b>Classic PKW BMW 3er Reihe/E30 (82-93)</b>								
	316 316 i 316 i Touring 318 i 318 i Cabrio 318 i Touring 318 iS 320 i 320 i Cabrio 320 i Touring 320 iS 323 i 324 d 324 td 324 td Touring 325 e 325 i 325 i Cabrio 325 i Touring 325 iX 325 iX Touring	66		03.82 07.87 06.91 03.82 07.90 09.87 02.89 01.82 04.86 01.88 09.87 09.82 04.85 02.87 01.88 10.83 09.83 07.85 07.87 03.86 03.88	07.88 12.91 06.94 12.91 05.93 06.94 12.91 12.91 12.92 09.93 12.91 <sup>1</sup> <sup>P</sup> 09.86 12.91 12.91 09.87 12.91 12.92 09.93 09.93 12.91 12.92	BA2026 BAV1002	1	21173 17,0 /WE/S LUC Warnkontakt L=250mm
	M3 M3 Cabrio			07.86 06.88	12.91 09.92	BA2188 BAV1007	1	20629 20,0 +/WE ATE Warnkontakt L=265mm
	316 316 i 318 i	66		03.82 07.87 03.82	07.88 - ABS 12.91 - ABS/ - Behörde <sup>1)</sup> 12.91 - ABS/ - Behörde/ - <sup>ABS</sup> <sup>2)</sup>	BAR13167		260 12,6 11,1
	316 316 i 316 i Touring 318 i 318 i Cabrio 318 i Touring 318 iS 320 i 320 i Cabrio	66		03.82 07.87 06.91 03.82 07.90 09.87 02.89 01.82 04.86	07.88 + ABS 12.91 + ABS/ + Behörde <sup>3)</sup> 06.94 12.91 + ABS/ + Behörde/ + <sup>ABS</sup> <sup>4)</sup> 05.93 06.94 12.91 12.92	BAR22122		260 22,0 20,4 V L

1) - ABS/ - authority cars / - ABS/ - enti statali / - ABS/ - véhicule communal / - ABS/ - vehiculos oficiales

























2) - ABS/ - authority cars/ - <sup>ABS</sup> / - ABS/ - enti statali/ - <sup>ABS</sup> / - ABS/ - véh.communal/ - <sup>ABS</sup> / - ABS/ - veh.oficiales/ - <sup>ABS</sup>























3) + ABS/ + authority cars / + ABS/ + enti statali / + ABS/ + véhicule communal / + ABS/ + vehiculos oficiales

























4) + ABS/ + authority cars/ + <sup>ABS</sup> / + ABS/ + enti statali/ + <sup>ABS</sup> / + ABS/ + véh.communal/ + <sup>ABS</sup> / + ABS/ + veh.oficiales/ + <sup>ABS</sup>

Classic PKW BMW 3er Reihe/E30 (82-93)									
	320 i Touring	95	01.88	09.93	BAR22122	260 22,0 20,4 V L			
	320 iS		09.87	12.91					
	323 i		09.82	09.86					
	324 d		04.85	12.91					
	324 td		02.87	12.91					
	324 td Touring	85	01.88	09.93					
	325 e		10.83	09.87					
	325 i		09.83	12.91					
	325 i Cabrio		07.85	12.92					
	325 i Touring		07.87	09.93					
	325 iX		03.86	12.91					
	325 iX Touring		03.88	09.93					
	316	66	03.82	07.88	BAV1007	Warnkontakt L=265mm			
	316 i		07.87	12.91					
	316 i Touring		06.91	06.94					
	318 i		03.82	12.91					
	318 i Cabrio		07.90	05.93					
	318 i Touring		09.87	06.94					
	318 iS		02.89	12.91					
	320 i		01.82	12.91					
	320 i		09.87	12.91					
	320 i Cabrio		04.86	12.92					
	320 i Touring	95	01.88	09.93					
	320 iS		09.87	12.91					
	323 i		09.82	09.86					
	324 d		04.85	12.91					
	324 td		02.87	12.91					
	324 td Touring	85	01.88	09.93					
	325 e		10.83	09.87					
	325 i		09.83	12.91					
	325 i Cabrio		07.85	12.92					
	325 i Touring		07.87	09.93					
	325 iX		03.86	12.91					
	325 iX Touring		03.88	09.93					
	M3		07.86	12.91					
	M3 Cabrio		06.88	09.92					
	Classic PKW BMW 5er Reihe/E12 (72-81)								
		518		08.76			05.81	BA2193 BAV1035	20437 19,0 /WE Warnkontakt L=165mm
		518 i		09.79			06.81		
		520 4	85	08.76			01.79		
		520 6	90	08.77			06.81		
		520 i		08.76			07.79		
		525		06.76			06.81		
528			08.76	07.77					
528 i			03.77	06.81					
M 535 i		160	04.80	05.81					
		525		10.73	06.81	BAV1035	Warnkontakt L=165mm		
		528		01.75	07.77				
	528 i		03.77	06.81					
	M 535 i	160	04.80	05.81					
Classic PKW BMW 5er Reihe/E28 (81-87)									
	518	66	06.81	09.84	BA2188 BAV1007	20629 20,0 +/WE Warnkontakt L=265mm			
	518 i		11.83	12.87					
	520 i		06.81	12.87					
	524 d	63	05.86	12.87					
	524 td	85	09.83	12.87					
	525 e		09.81	12.87					
	525 i	110	02.81	12.87					
	528 i	135	06.81	12.87					
	535 i		01.85	12.87					
	M 535 i		01.85	12.87					
	M5	211	08.85	12.87					
		518	66	06.81			09.84	BA2189 BAV1035	20675 17,0 +/WE Warnkontakt L=165mm
518 i			11.83	12.87					
520 i			06.81	03.86					
520 i			04.86	12.87					
524 d		63	05.86	12.87					
524 td		85	09.83	03.86					
524 td		85	04.86	12.87					
525 e			09.81	12.87					
525 i		110	02.81	12.87					
528 i		135	06.81	12.87					
535 i			01.85	12.87					
M 535 i			01.85	12.87					
M5		211	08.85	12.87					
Classic PKW BMW 6er Reihe/E24 (76-89)									
		628 CSi	135	09.79	04.82	BA2193 BAV1035	20437 19,0 /WE Warnkontakt L=165mm		
		630 CS	136	09.76	08.79				
		633 CSi		09.76	04.82				
	635 CSi		06.78	04.82					
	628 CSi	135	05.82	05.87					
↓	635 CSi		05.82	04.89	BA2188 BAV1007	20629 20,0 +/WE Warnkontakt L=265mm			

1) + ABS/ + authority cars / + ABS/ + enti statali / + ABS/ + vchicule communal / + ABS/ + vehiculos oficiales  
 2) + ABS/ + authority cars/ + ABS / + enti statali / + ABS / + vch. communal / + ABS / + veh. oficiales / + ABS  
 3) + authority cars / + enti statali / + vchicule communal / + vehiculos oficiales

								
<b>Classic PKW BMW 6er Reihe/E24 (76-89)</b>								
	M 635 CSi		04.84	04.89	BA2193 BAV1003	1		20437 19,0 /WE Warnkontakt L=230mm ATE
	628 CSi	135	09.79	04.82	BAV1035	1		Warnkontakt L=165mm
	630 CS	136	02.76	08.79				
	633 CSi		01.76	04.82				
	635 CSi		06.78	04.82				
	628 CSi	135	05.82	05.87	BA2189 BAV1035	1		20675 17,0 +/-WE Warnkontakt L=165mm ATE
	635 CSi		05.82	04.89				
	M 635 CSi		04.84	04.89				
<b>Classic PKW BMW 7er Reihe/E23 (77-86)</b>								
	728	125	04.77	09.79	BA2193 BAV1035	1		20437 19,0 /WE Warnkontakt L=165mm ATE
	728 i	135	07.78	08.82				
	730	135	05.77	08.79				
	732 i	145	05.77	04.86				
	733 i	145	05.77	07.82				
	735 i		09.79	08.81				
	728 i	135	09.82	05.86	BA2193 BAV1035	1		20437 19,0 /WE Warnkontakt L=165mm ATE
	735 i		09.81	05.86				
	745 i	185	04.80	05.86				
	728	125	04.77	09.79	BAV1035	1		Warnkontakt L=165mm
	728 i	135	07.78	08.81				
	730	135	05.77	08.79				
	732 i	145	05.77	08.81				
	733 i	145	05.77	08.81				
	735 i		09.79	08.81				
	745 i	185	04.80	08.81				
	728 i	135	09.81	05.86	BA2189 BAV1035	1		20675 17,0 +/-WE Warnkontakt L=165mm ATE
	732 i	145	09.81	04.86				
	733 i	145	09.81	07.82				
	735 i		09.81	04.86				
	745 i	185	09.81	05.86				
<b>Classic PKW BMW M1 (79-83)</b>								
	M1		05.79	05.83	BA2193			20437 19,0 /WE ATE
	M1		05.79	05.83	BA2185			20588 16,5 /WE ATE
<b>Classic PKW BMW Z1 (88-91)</b>								
	2.5	125	07.88	06.91	BA2026 BAV1002	1		21173 17,0 /WE/S Warnkontakt L=250mm LUC
	2.5	125	07.88	06.91	BAR22122			260 22,0 20,4 V L
	2.5	125	07.88	08.90	BA2054 BAV1007	1		20995 17,3 +/-WE Warnkontakt L=265mm ATE
	2.5	125	09.90	06.91	BA2053 BAV1007	1		20180 17,3 +/-WE Warnkontakt L=265mm ATE
<b>Classic PKW CITROEN BX (82-93)</b>								
	1.4	44	01.87	01.92	BA2056			20635 18,0 +/-WK BDX
	1.4	52	01.87	01.92				
	1.6	85	01.87	01.92				
	1.9 4X4	92	02.92	06.94				
	1.9 D	52	01.87	01.92				
	14		09.82	12.93				
	16		09.82	12.93				
	18 D	44	10.85	09.93				
	18 TRD	66	09.88	12.93				
	19	70	02.88	12.93				
	19	75	09.85	12.93				
	19	77	10.84	08.85				
	19 D	47	09.82	08.87				
	19 D	51	09.87	12.93				
	19 E	80	02.88	12.93				
	19 GTi	88	09.88	12.93				
	19 GTi	90	06.86	08.88				
	19 GTi 16V	108	09.88	12.93				
	19 GTi 16V	116	09.87	08.88				
	19 GTi 16V	108	09.88	12.93				
	19 GTi 16V	116	09.87	08.88				
<b>Classic PKW CITROEN C15 (84-05)</b>								
	1.0	ORGA 04196		12.97	BA2020			21614 17,5 +/-WK LUC
	1.1 (1118)	44	09.87	12.96 + (E)				
	1.1 (1124)	ORGA 04196		12.96				
	1.3		09.87	05.88 + (E)				
	1.4	49	07.96	12.96				
	1.4	55	05.87	07.96				
↓	↓							

	   KW							
<b>Classic PKW CITROEN C15 (84-05)</b>								
	1.8 D 1.8 D	44		10.84 04.87	12.00 08.00		BA2020	21614 17,5 +/-WK LUC
	1.9 D			12.00	12.05		BA2074	20905 18,0 +/-WK BDX
	1.0 1.1 (1118) 1.1 (1124) 1.3 1.4 1.4 1.8 D 1.8 D 1.9 D	44 44 44 49 55 44	ORGA 04196 ORGA 04196 ORGA 04196 ORGA 04196 ORGA 04196	09.87 09.87	12.97 12.96 + F 12.96 05.88 + F 12.96 07.96		BAR10187	247 10,0 8,0
<b>Classic PKW CITROEN C25 (81-94)</b>								
	1.8 1.9 D 1.9 DT 1.9 TD 2.0 2.5 D 2.5 D 4X4 2.5 TD	60 55		07.87 07.87 10.91 04.92 11.81 10.85 11.83 08.87	03.94 03.94 01.94 03.94 03.94 03.94 -1,8 t 12.86 -1,8 t 03.94 -1,8 t		BA2024	20741 19,2 +/-WK/S LUC
	1.8 1.9 D 1.9 DT 1.9 TD 2.0 2.5 D 2.5 D 4X4 2.5 TD	155248 155248 60 155248 155248 155248 55 155248 155248		04.92	03.94 03.94 01.94 03.94 03.94 03.94 -1,8 t 12.86 -1,8 t 03.94 -1,8 t		BAR16105	256 16,1 13,5
	1.8 1.9 D 1.9 DT 1.9 TD 2.0 2.5 D 2.5 D 4X4 2.5 TD	073501 073501 60 073501 073501 073501 55 073501 073501		04.92	03.94 -0,8 t 03.94 01.94 03.94 03.94 03.94 -1,8 t 12.86 -1,8 t 03.94 -1,8 t		BAW2501	Rz 25,40 LUC
<b>Classic PKW CITROEN VISA (78-89)</b>								
	1.7 D			04.84	12.89		BA2020	21614 17,5 +/-WK LUC
	1.7 D			04.84	12.89		BAR10187	247 10,0 8,0
<b>Classic PKW FIAT 124 (66-74)</b>								
	alle Typen			01.66	08.74		BA2062	20073 17,3 BDX
<b>Classic PKW FIAT 125 (66-74)</b>								
	1.6 1.6 Special			07.67 05.69	03.74 10.73		BA2062	20073 17,3 BDX
<b>Classic PKW FIAT 127 (71-86)</b>								
	0.9 1.0 1.0 Sport 1.3 D 1.3 Sport			02.71 04.77 07.78 04.81 04.81	05.83 05.83 02.82 12.86 12.86		BA2062	20073 17,3 BDX
	1.3 Sport Fiorino			10.77	12.86 12.86		BAW1902	Rz 19,05
<b>Classic PKW FIAT 128 (69-84)</b>								
	1.1 1.3			01.69 09.71	12.84 12.84		BA2062	20073 17,3 BDX
<b>Classic PKW FIAT 131 (74-84)</b>								
	alle Typen alle Typen			06.74 09.82	06.79 06.84		BA2062 BA2065	20073 17,3 BDX 20775 18,0 /WK BDX
<b>Classic PKW FIAT 132 (72-81)</b>								
	alle Typen			04.72	05.81		BA2062	20073 17,3 BDX

								
<b>Classic PKW FIAT DUCATO (81-93)</b>								
	1.8 1.9 D 2.0 2.4 D 2.4 TD 2.5 D 2.5 TD		09.81 02.87 09.81 05.81 01.86 01.86 07.90	01.94 01.94 01.94 12.85 06.90 01.94 01.94		BA2024		20741 19,2 +WK/S LUC
	1.8 1.9 D 2.0 2.4 D 2.4 TD 2.5 D 2.5 TD	154462 154462 154462	02.87 01.94 01.94 12.85 01.86 01.86 07.90	01.94 01.94 01.94 12.85 06.90 01.94 01.94		BAR16105		256 16,1 13,5
	1.8 1.9 D 2.0 2.4 D 2.4 TD 2.5 D 2.5 TD	77161 77161 77161	02.87 01.94 01.94 12.85 01.86 01.86 07.90	01.94 01.94 01.94 12.85 06.90 01.94 01.94		BAW2501		Rz 25,40 LUC
<b>Classic PKW FIAT PANDA (80-85)</b>								
	30 34 45		05.80 05.80 05.80	08.82 08.82 08.82		BA2062		20073 17,3 BDX
	30 34 45 4x4		09.82 09.82 09.82 09.83	12.85 12.85 12.85 12.85		BA2064		20775 18,0 /WE BDX
	30 34 45 4x4	6261412 6261412 6261412	09.83	12.85 12.85 12.85 12.85		BAW1902		Rz 19,05
<b>Classic PKW FIAT REGATA (83-89)</b>								
	1.3 1.5 Lim. 1.6 Lim. 1.7 D 1.9 D Lim. 1.9 TD Lim.		09.83 09.83 09.83 09.83 04.84 05.86	09.89 09.89 09.89 03.89 09.89 09.89		BA2065		20775 18,0 /WK BDX
	1.3 1.5 1.6 1.7 D 1.9 D 1.9 TD		09.83 09.83 09.83 09.83 04.84 05.86	09.89 09.89 09.89 03.89 09.89 09.89		BAW1902		Rz 19,05
<b>Classic PKW FIAT RITMO (78-88)</b>								
	1.7 D 60 65 75		03.80 09.78 09.78 09.78	08.82 08.82 09.82 09.82		BA2062		20073 17,3 BDX
	1.1 1.3 1.5 1.7 D 60		05.85 05.85 05.85 09.82 09.82	09.87 09.87 09.87 09.87 04.85		BA2065		20775 18,0 /WK BDX
	1.1 1.3 1.5 1.7 D 1.9 TD 105 TC 125 TC 130 TC		05.85 05.85 05.85 05.85 06.86 05.81 09.81 07.83	09.87 09.87 09.87 09.87 06.88 12.85 12.86 06.88		BAW1902		Rz 19,05
<b>Classic PKW FIAT TEMPRA (90-93)</b>								
	1.4 i.e. Lim. 1.6 i.e. Lim.		03.90 03.90	04.93 - ABS/ + Schaltgetriebe <sup>1)</sup> 04.93 - ABS/ + Schaltgetriebe <sup>1)</sup>		BA2033		21100 17,0 +WK/S LUC
	1.4 i.e. Kombi 1.4 i.e. Lim. 1.4 i.e. Lim. 1.6 i.e. Kombi 1.6 i.e. Lim. 1.6 i.e. Lim. 1.8 i.e. 1.9 D 1.9 TD 2.0 i.e.		03.90 03.90 03.90 03.90 03.90 03.90 03.90 03.90 03.90 03.90	04.93 04.93 + ABS/ + Schaltgetriebe <sup>2)</sup> 04.93 + Automatikgetriebe <sup>3)</sup> 04.93 04.93 + ABS/ + Schaltgetriebe <sup>2)</sup> 04.93 + Automatikgetriebe <sup>3)</sup> 04.93 04.93 04.93 04.93		BA2034		20833 17,1 +WK/S LUC
	1.4 i.e. Lim. 1.6 i.e. Lim.		03.90 03.90	04.93 - ABS/ + Schaltgetriebe <sup>1)</sup> 04.93 - ABS/ + Schaltgetriebe <sup>1)</sup>		BAR11119		240 11,0 9,2
	1.4 i.e. Kombi 1.4 i.e. Lim. 1.4 i.e. Lim.		03.90 03.90 03.90	04.93 04.93 + ABS/ + Schaltgetriebe <sup>2)</sup> 04.93 + Automatikgetriebe <sup>3)</sup>		BAR12127		257 12,0 10,2

<sup>1)</sup> - ABS/ + manual transmission / - ABS/+ scatola camb. velocità / - ABS/ + transmission mécanique / - ABS/ + cambio de velocidad

<sup>2)</sup> + ABS/ + manual transm. / + ABS/+ scatola camb. velocità / + ABS/ + transmission mécanique / + ABS/ + cambio de velocidad

<sup>3)</sup> + autom. transmission / + scatola cambio automatico / + transmission automatique / + cambio automático

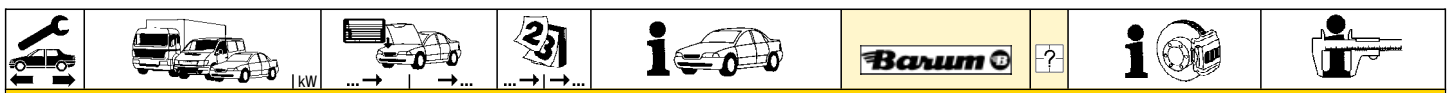

















**Classic PKW FIAT TEMPRA (90-93)**

	1.6 i.e. Kombi		03.90	04.93	BAR12127		257 12,0 10,2
	1.6 i.e. Lim.		03.90	04.93 + ABS/ + Schaltgetriebe <sup>1)</sup>			
	1.6 i.e. Lim.		03.90	04.93 + Automatikgetriebe <sup>2)</sup>			
	1.8 i.e. Lim.		03.90	04.93			
	1.9 D		03.90	04.93			
	1.9 TD Lim.		03.90	04.93			
	1.8 i.e. Kombi		03.90	04.93	BAR20142		258 20,0 18,2 V L
	1.9 TD Kombi		03.90	04.93			
	2.0 i.e.		03.90	04.93			
	1.4 i.e.		03.90	04.93 + ABS	BA2035		21103 14,4 /S LUC
	1.6 i.e.		03.90	04.93 + ABS			
	1.8 i.e.		03.90	04.93 + ABS			
	1.9 D		03.90	04.93 + ABS			
	1.9 TD		03.90	04.93 + ABS			
	2.0 i.e.		03.90	04.93			
	1.4 i.e.		03.90	04.93 + ABS	BAR11119		240 11,0 9,2
	1.6 i.e.		03.90	04.93 + ABS			
	1.8 i.e.		03.90	04.93 + ABS			
	1.9 D		03.90	04.93 + ABS			
	1.9 TD		03.90	04.93 + ABS			
	2.0 i.e.		03.90	04.93			

**Classic PKW FIAT TIPO (88-93)**























	1.1		01.88	04.93 - ABS	BA2033		21100 17,0 +WK/S LUC
	1.4		01.88	04.93 - ABS			
	1.4 i.e.		01.88	04.93 - ABS			
	1.6		01.88	04.93 - ABS/ + Schaltgetriebe <sup>3)</sup>			
	1.6 i.e.	57	01.88	04.93 - ABS/ + Schaltgetriebe <sup>3)</sup>			
	1.7 D		01.88	04.93 - ABS			
	1.9 D		01.88	04.93 - ABS			
	1.1		01.88	04.93 + ABS			
1.4		01.88	04.93 + ABS				
1.4 i.e.		01.88	04.93 + ABS				
1.6		01.88	04.93 + ABS/ + Schaltgetriebe <sup>1)</sup>				
1.6		01.88	04.93 + Automatikgetriebe <sup>2)</sup>				
1.6 i.e.	57	01.88	04.93 + ABS/ + Schaltgetriebe <sup>1)</sup>				
1.6 i.e.	57	01.88	04.93 + Automatikgetriebe <sup>2)</sup>				
1.6 i.e.	66	01.88	12.91				
1.7 D		01.88	04.93 + ABS				
1.8 i.e.		03.90	04.93				
1.8 i.e. 16V	101	10.89	04.93				
1.9 D		01.88	04.93 + ABS				
1.9 TD		01.88	04.93				
2.0 i.e.	80	09.90	04.93				
	1.1		01.88	04.93 - ABS	BAR11119		240 11,0 9,2
	1.4		01.88	04.93 - ABS			
	1.4 i.e.		01.88	04.93 - ABS			
	1.6		01.88	04.93 - ABS/ + Schaltgetriebe <sup>3)</sup>			
	1.6 i.e.	57	01.88	04.93 - ABS/ + Schaltgetriebe <sup>3)</sup>			
	1.7 D		01.88	04.93 - ABS			
	1.9 D		01.88	04.93 - ABS			
	1.1		01.88	04.93 + ABS			
1.4		01.88	04.93 + ABS				
1.4 i.e.		01.88	04.93 + ABS				
1.6		01.88	04.93 + ABS/ + Schaltgetriebe <sup>1)</sup>				
1.6		01.88	04.93 + Automatikgetriebe <sup>2)</sup>				
1.6 i.e.	57	01.88	04.93 + ABS/ + Schaltgetriebe <sup>1)</sup>				
1.6 i.e.	57	01.88	04.93 + Automatikgetriebe <sup>2)</sup>				
1.6 i.e.	66	01.88	12.91				
1.7 D		01.88	04.93 + ABS				
1.8 i.e.		03.90	04.93				
1.9 D		01.88	04.93 + ABS				
1.9 TD		01.88	04.93				
1.8 i.e. 16V	101	10.89	04.93	BAR20142		258 20,0 18,2 V L	
2.0 i.e.	80	09.90	04.93				
	1.1		01.88	04.93 + ABS	BA2035		21103 14,4 /S LUC
	1.4		01.88	04.93 + ABS			
	1.4 i.e.		01.88	04.93 + ABS			
	1.6		01.88	04.93 + ABS			
	1.6 i.e.		01.88	04.93 + ABS			
	1.7 D		01.88	04.93 + ABS			
	1.8 i.e.		03.90	04.93 + ABS			
	1.8 i.e. 16V	101	10.89	04.93			
	1.9 D		01.88	04.93 + ABS			
	1.9 TD		01.88	04.93 + ABS			
	2.0 i.e.		09.90	04.93			
2.0 i.e. 16V		01.91	04.93				
	1.1		01.88	04.93 + ABS	BAR11119		240 11,0 9,2
	1.4		01.88	04.93 + ABS			
	1.4 i.e.		01.88	04.93 + ABS			
	1.6		01.88	04.93 + ABS			
	1.6 i.e.		01.88	04.93 + ABS			
	1.7 D		01.88	04.93 + ABS			
	1.8 i.e.		03.90	04.93 + ABS			
	1.8 i.e. 16V	101	10.89	04.93			
1.9 D		01.88	04.93 + ABS				

1) + ABS/ + manual transm. / + ABS/+ scatola camb.velocità / + ABS/ + transmission mécanique / + ABS/ + cambio de velocidad  
 2) + autom.transmission / + scatola cambio automatico / + transmission automatique / + cambio automático  
 3) - ABS/ + manual transmission / - ABS/+ scatola camb.velocità / - ABS/ + transmission mécanique / - ABS/ + cambio de velocidad

								
<b>Classic PKW FIAT TIPO (88-93)</b>								
	1.9 TD 2.0 i.e. 2.0 i.e. 16V		01.88 09.90 01.91	04.93 + ABS 04.93 04.93	BAR11119			240 11,0 9,2
<b>Classic PKW FIAT UNO (83-89)</b>								
	1.3 D 1.7 D 45 55 60 70 75		03.83 02.84 03.83 03.83 03.83 03.83 10.85	09.89 09.89 09.89 09.89 09.89 09.89 09.89	BA2064 BA2065			20775 18,0 /WE 20775 18,0 /WK BDX BDX
	1.3 D 1.7 D 1.7 TD 45 55 60 70 75		03.83 02.84 05.86 03.83 03.83 03.83 10.85	09.89 09.89 09.89 + ① 09.89 09.89 09.89 09.89	BAW1902			Rz 19,05
<b>Classic PKW FIAT UNO (90-95)</b>								
	1.0 i.e. 1.1 i.e. 1.4 i.e. 1.5 i.e.		10.89 10.89 10.89 10.89	06.95 06.95 06.95 06.95	BA2064 BA2065			20775 18,0 /WE 20775 18,0 /WK BDX BDX
	1.7 D 1.0 i.e. 1.1 i.e. 1.4 i.e. 1.4 TD 1.5 i.e. 1.7 D 1.9 TD		10.89 10.89 10.89 10.89 10.89 10.89 10.89	06.95 06.95 06.95 06.95 06.95 06.95 06.95 + ①	BA2064 BAW1902			20775 18,0 /WE Rz 19,05 BDX
<b>Classic PKW FIAT X 1/9 (72-89)</b>								
	1.3 1.5		10.72 11.78	12.79 09.82	BA2062			20073 17,3 BDX
<b>Classic PKW FORD CONSUL / GRANADA (72-85)</b>								
	1.7 Lim. 1.9 D Lim. 2.0 Lim. 2.1 D Lim. 2.3 Kombi 2.3 Lim. 2.6 Kombi 2.6 Lim. 3.0 Kombi 3.0 Lim.		02.72 08.77 08.77 08.77 08.77 08.77 08.77 08.77 08.77 08.77	04.79 04.79 + ② (DK) (N) (S) (FIN) 04.79 + 4 Zylinder ①) 04.79 + ② (DK) (N) (S) (FIN) 04.79 + ② (DK) (N) (S) (FIN) 04.79 + ② (DK) (N) (S) (FIN) 04.79 + ② (DK) (N) (S) (FIN) 04.79 + ② (DK) (N) (S) (FIN) 04.79 + ② (DK) (N) (S) (FIN) 04.79 + ② (DK) (N) (S) (FIN) 04.79 + ② (DK) (N) (S) (FIN)	BAW2007			Rz 20,64
	1.7 Kombi 1.9 D Lim. 2.0 Kombi 2.0 Lim. 2.1 D Lim. 2.3 Kombi 2.3 Lim. 2.6 Kombi 2.6 Lim. 2.8 i Kombi 2.8 i Lim. 2.8 Kombi 2.8 Lim. 3.0 Kombi 3.0 Lim.	66	02.72 08.77 02.72 02.72 08.77 02.72 02.72 02.72 08.77 08.77 08.77 08.77 02.72 02.72	04.79 04.79 - ② (DK) (N) (S) (FIN) 04.79 - ② (DK) (N) (S) (FIN) 04.79 - ② (DK) (N) (S) (FIN) 04.79 - ② (DK) (N) (S) (FIN) 04.79 - ② (DK) (N) (S) (FIN) 04.79 - ② (DK) (N) (S) (FIN) 04.79 - ② (DK) (N) (S) (FIN) 04.79 - ② (DK) (N) (S) (FIN) 04.79 - ② (DK) (N) (S) (FIN) 04.79 - ② (DK) (N) (S) (FIN) 04.79 - ② (DK) (N) (S) (FIN) 04.79 - ② (DK) (N) (S) (FIN) 02.76 02.76	BAW1901	nur paarweise austauschen ②)		Rz 19,05 LUC
	1.7 Kombi 1.7 Lim. 1.9 D Lim. 2.0 Kombi 2.0 Lim. 2.1 D Lim. 2.3 Kombi 2.3 Lim. 2.8 i Kombi 2.8 i Lim. 2.8 Kombi 2.8 Lim.	66	05.79 05.79 05.79 05.79 05.79 05.79 05.79 05.79 05.79 05.79 05.79	07.81 + ② (DK) (FIN) 07.81 + ② (DK) (FIN) 07.81 + ② (DK) (FIN) 07.81 + ② (DK) (FIN) 07.81 + ② (DK) (FIN) 07.81 + ② (DK) (FIN) 07.81 + ② (DK) (FIN) 07.81 + ② (DK) (FIN) 07.81 + ② (DK) (FIN) 07.81 + ② (DK) (FIN) 07.81 + ② (DK) (FIN)	BAW1901	nur paarweise austauschen ②)		Rz 19,05 LUC
	1.7 Kombi 1.7 Lim. 1.9 D Lim. 2.0 Kombi 2.0 Lim. 2.1 D Lim. 2.3 Kombi 2.3 Lim.	66	05.79 05.79 05.79 05.79 05.79 05.79 05.79 05.79	07.81 - ② (DK) (FIN) 07.81 - ② (DK) (FIN) 07.81 - ② (DK) (FIN) 07.81 - ② (DK) (FIN) 07.81 - ② (DK) (FIN) 07.81 - ② (DK) (FIN) 07.81 - ② (DK) (FIN) 07.81 - ② (DK) (FIN)	BAW2007		Rz 20,64	

①) + 4 cylinder / + 4 cilindro / + 4 cylindre / + 4 cilindro

②) to change only by pairs / sostituire solo a coppie / à changer seulement par paires / cambiar solamente por parejas

									
<b>Classic PKW FORD CONSUL / GRANADA (72-85)</b>									
	2.8 i Kombi 2.8 i Lim. 2.8 Kombi 2.8 Lim.		05.79 05.79 05.79 05.79	07.81 07.81 07.81 07.81	- OK - OK - OK - OK	FIN FIN FIN FIN	BAW2007		Rz 20,64
	1.6 Lim. 1.9 D Lim. 2.0 Kombi 2.0 Lim. 2.1 D Lim. 2.3 Kombi 2.3 Lim. 2.5 D Kombi 2.5 D Lim. 2.8 i Kombi 2.8 i Lim. 2.8 Kombi 2.8 Lim.		08.81 08.81 08.81 08.81 08.81 08.81 08.81 08.81 08.81 08.81 08.81 08.81 08.81	08.85 08.82 08.85 08.85 08.82 08.85 08.85 08.85 08.85 08.85 08.85 08.85 08.85			BAW2201		Rz 22,20
<b>Classic PKW FORD ESCORT / ORION (81-85)</b>									
	alle Typen		08.80	12.85	- Turbo		BA2144		20640 18,0 + ATE
	1.6 XR3 XR3i		08.80 08.80 09.82	12.85 10.82 12.85	- Turbo		BAR24112		240 24,2 22,2 V
	alle Typen		08.80	02.83	- Kastenwagen/ - XR3i <sup>1)</sup>		BAW1901	nur paarweise austauschen <sup>2)</sup>	Rz 19,05 LUC
	alle Typen XR3i		03.83 09.82	12.85 12.85	- Kastenwagen <sup>3)</sup>		BAW1901	nur paarweise austauschen <sup>2)</sup>	Rz 19,05 LUC
	Kastenwagen		08.80	12.85			BAW2201		Rz 22,20
<b>Classic PKW FORD ESCORT / ORION (86-90)</b>									
	alle Typen		01.86	08.90	- Turbo		BA2144		20640 18,0 + ATE
	1.3 1.4 1.6 1.6 D 1.8 D XR3i		01.86 01.86 01.86 01.86 04.89 01.86	08.90 08.90 08.90 03.89 08.90 08.90	+ SCS  - Turbo + SCS		BAR24112		240 24,2 22,2 V
	alle Typen		01.86	08.90	- SCS/ - Turbo/ - Kastenwagen <sup>4)</sup>		BAW1901	nur paarweise austauschen <sup>2)</sup>	Rz 19,05 LUC
	alle Typen Kastenwagen		01.86 01.86	08.90 08.90	+ SCS/ - Turbo		BAW2201		Rz 22,20
<b>Classic PKW FORD FIESTA (76-89)</b>									
	1.6 XR2		09.81	04.89			BA2144		20640 18,0 + ATE
<b>Classic PKW FORD PROBE (91-92)</b>									
	2.2 i 2.2 i Turbo 3.0 i V6		12.90 12.90 12.90	12.92 12.92 12.92			BA2110		21378 15,0 +/WK AKE
<b>Classic PKW FORD SCORPIO / GRANADA (GB) (85-91)</b>									
	alle Typen		03.85	01.92			BA2030		20981 13,7 /S LUC
<b>Classic PKW FORD SCORPIO / GRANADA (GB) (92-94)</b>									
	2.0 i 2.4 i V6 2.5 TD 2.9 i V6		08.92 08.92 08.92 08.92	09.94 09.94 09.94 09.94			BA2139		21394 18,0 + ATE
	2.0 i 2.4 i V6 2.5 TD 2.9 i V6		02.92 02.92 02.92 02.92	09.94 09.94 09.94 09.94			BA2030		20981 13,7 /S LUC
<b>Classic PKW FORD SIERRA (82-86)</b>									
	1.6 Kombi 1.8 2.0 2.0 i 2.3 2.3 D		05.86 10.84 08.82 02.85 08.82 08.82	12.86 12.86 12.86 12.86 12.86 12.86	- ABS - ABS - ABS - ABS - ABS - ABS		BA2144		20640 18,0 + ATE
	1.6 Kombi 1.8 2.0 2.0 i 2.3 2.3 D		05.86 10.84 08.82 02.85 08.82 08.82	12.86 12.86 12.86 12.86 12.86 12.86	- ABS - ABS - ABS - ABS - ABS - ABS		BAR24112		240 24,2 22,2 V

<sup>1)</sup> - Van/ - XR3i / - furgone/ - XR3i / - fourgonnette/ - XR3i / - furgón/ - XR3i

<sup>2)</sup> to change only by pairs / sostituire solo a coppie / à changer seulement par paires / cambiar solamente por parejas

<sup>3)</sup> - Van / - furgone / - fourgonnette / - furgón

<sup>4)</sup> - SCS/ - Turbo/ - Van / - SCS/ - Turbo/ - furgone / - SCS/ - Turbo/ - fourgonnette / - SCS/ - Turbo/ - furgón



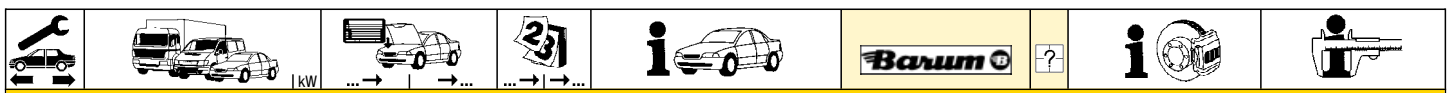

**Classic PKW FORD SIERRA (82-86)**

	2.0 i 2.8 i alle Typen	02.85 02.85 03.86	12.86 12.86 12.86 + ABS	BA2030		20981 13,7 /S	LUC
	2.0 i 2.8 i alle Typen	02.85 02.85 03.86	12.86 12.86 12.86 + ABS	BAR10115		253 10,2 8,9	
	1.6 Kombi 1.8 2.0 2.3 2.3 D 2.8 XR4i	08.82 10.84 08.82 08.82 08.82 04.83	12.86 12.86 12.86 12.86 12.86 03.85	BAW2007	9" Bremse <sup>1)</sup>	Rz 20,64	
				BAW2201	10" Bremse <sup>2)</sup>	Rz 22,20	























**Classic PKW FORD SIERRA (87-93)**

	1.6 Kombi 1.6 Lim. 1.8 Kombi 1.8 Lim. 1.8 TD Kombi 1.8 TD Lim. 2.0 i Kombi 2.0 i Lim. 2.0 Kombi 2.0 Lim. 2.3 D Kombi 2.3 D Lim.	01.87 01.87 01.87 01.87 08.88 01.90 01.87 01.87 01.87 01.87 01.87 01.87	02.93 02.93 02.93 02.93 02.93 02.93 02.93 02.93 02.93 02.93 02.93 02.93	BA2144		20640 18,0 +	ATE
	1.6 Kombi 1.6 Lim. 1.8 Kombi 1.8 Lim. 1.8 TD Kombi 1.8 TD Lim. 2.0 i Kombi 2.0 i Lim. 2.0 Kombi 2.0 Lim. 2.3 D Kombi 2.3 D Lim.	01.87 01.87 01.87 01.87 08.88 01.90 01.87 01.87 01.87 01.87 01.87 01.87	02.93 02.93 02.93 02.93 02.93 02.93 02.93 02.93 02.93 02.93 02.93 02.93	BAR24112		240 24,2 22,2 V	
	1.6 Kombi 1.6 Lim. 1.8 Kombi 1.8 Lim. 1.8 TD Kombi 1.8 TD Lim. 2.0 i 4x4 Kombi 2.0 i 4x4 Lim. 2.0 i Kombi 2.0 i Lim. 2.0 Kombi 2.0 Lim. 2.0 RS Cosworth Turbo 2.8 i 4x4 Kombi 2.8 i Kombi 2.8 i Lim. 2.9 i 4x4 Kombi 2.9 i 4x4 Lim. 2.9 i Kombi 2.9 i Lim.	01.87 01.87 01.87 01.87 08.88 01.90 05.89 01.90 01.87 01.87 01.87 01.87 01.87 01.87 01.87 01.87 08.88 08.88 08.88 08.88	02.93 02.93 02.93 02.93 02.93 02.93 02.93 02.93 02.93 02.93 02.93 02.93 12.89 02.93 02.93 08.88 02.93 02.93 02.93 02.93	BA2030		20981 13,7 /S	LUC
	1.6 Kombi 1.6 Lim. 1.8 Kombi 1.8 Lim. 1.8 TD Kombi 1.8 TD Lim. 2.0 i 4x4 Kombi 2.0 i 4x4 Lim. 2.0 i Kombi 2.0 i Lim. 2.0 Kombi 2.0 Lim. 2.8 i 4x4 Kombi 2.8 i Kombi 2.8 i Lim. 2.9 i 4x4 Kombi 2.9 i 4x4 Lim. 2.9 i Kombi 2.9 i Lim.	01.87 01.87 01.87 01.87 08.88 01.90 05.89 01.90 01.87 01.87 01.87 01.87 01.87 01.87 01.87 08.88 08.88 08.88 08.88	02.93 02.93 02.93 02.93 02.93 02.93 02.93 02.93 02.93 02.93 02.93 02.93 02.93 02.93 02.93 02.93 02.93 02.93 02.93	BAR10115		253 10,2 8,9	
	1.8 Lim. 1.8 TD Lim. 2.0 i 4x4 Lim. 2.0 i Lim. 2.0 Lim. 2.3 D Lim. 2.9 i 4x4 Lim.	01.87 01.90 01.90 01.87 01.87 01.87 08.88	02.93 02.93 02.93 02.93 02.93 02.93 02.93	BAW2007	9" Bremse <sup>1)</sup>	Rz 20,64	
	1.6 Kombi 1.8 Kombi	01.87 01.87	02.93 02.93	BAW2201	10" Bremse <sup>2)</sup>	Rz 22,20	

<sup>1)</sup> 9" brake / servofreno da 9" / frein de 9" / freno de 9"

<sup>2)</sup> 10" brake / servofreno da 10" / frein de 10" / freno de 10"

<sup>3)</sup> - ABS/ + RA drum brake / - ABS/ + P freno a tamburo / - ABS/ + fr. à tambour essieu AR / - ABS/ + ET tambores de freno

								
<b>Classic PKW FORD SIERRA (87-93)</b>								
	1.8 TD Kombi 2.0 i 4x4 Kombi 2.0 i Kombi 2.0 Kombi 2.3 D Kombi 2.8 i 4x4 Kombi 2.9 i 4x4 Kombi		08.88 05.89 01.87 01.87 01.87 01.87 08.88	02.93 02.93 02.93 02.93 02.93 02.93 02.93	- ABS - ABS - ABS - ABS - ABS - ABS - ABS	BAW2201	10" Bremse <sup>1)</sup>	Rz 22,20
<b>Classic PKW FORD TAUNUS / CORTINA (GB) (70-82)</b>								
	1.3 Kombi 1.3 Lim. 1.6 Kombi 1.6 Lim. 51		07.70 07.70 07.70 07.70	03.71 03.71 03.71 03.71	- verstärkte Bremse <sup>2)</sup> - verstärkte Bremse <sup>2)</sup>	BAW2007		Rz 20,64
	1.3 Kombi 1.3 Lim. 1.6 Kombi		07.70 04.71 07.70	12.75 12.75 12.75	+ verstärkte Bremse <sup>3)</sup> + verstärkte Bremse <sup>3)</sup>	BAW1901	nur paarweise austauschen <sup>4)</sup>	Rz 19,05 LUC
	1.3 Kombi 1.6 Kombi		01.76 01.76	09.82 09.82	- Ⓢ	BAW1901	nur paarweise austauschen <sup>4)</sup>	Rz 19,05 LUC
	1.6 Kombi 1.6 Lim. 2.0 Lim. 2.3 Lim.		01.76 01.76 01.76 01.76	09.82 09.82 09.82 09.82	+ Ⓢ	BAW1702	9" Bremse/nur paarw. tauschen <sup>5)</sup>	Rz 17,78 LUC
<b>Classic PKW HONDA ACCORD (81-85)</b>								
	1.6 (AC) 1.8 (AD)		09.83 09.83	08.85 08.85		BA2111		21012 15,0 AKE
<b>Classic PKW HONDA CIVIC (3-türig) (87-91)</b>								
	1.6 i 16V VTEC (EE9)		06.90	08.91		BAR21105		262 21,0 19,0 V
<b>Classic PKW HONDA CRX (87-91)</b>								
	1.6 i 16V VTEC (EE8)		06.90	08.91		BAR21105		262 21,0 19,0 V
<b>Classic PKW HYUNDAI STELLAR (84-90)</b>								
	1.6 56		06.86	02.90		BA2111		21012 15,0 AKE
<b>Classic PKW ISUZU TROOPER (86-91)</b>								
	2.2 TD (UBS52) 53 4524289 2.3 (UBS16) 66 4524289 2.6 i (UBS17) 85 4524289 2.8 TD (UBS55) 4524289			12.91 12.91 12.91 12.91		BA2114		21544 16,5 +/-WK AKE
<b>Classic PKW LADA NOVA (2104/2105) (75-96)</b>								
	1200 1300 1500		02.81 02.81 09.75	12.96 12.96 12.96		BA2041		20166 16,0 LUC
	1200 1300 1500		02.81 02.81 09.75	12.96 12.96 12.96		BAR11115		253 10,0 9,0
<b>Classic PKW LADA 1200-1600 (2101/2102/2103/2106) (73-86)</b>								
	1200 1300 1500 1600		05.73 09.74 09.75 12.75	06.86 06.86 06.85 06.85		BA2041		20166 16,0 LUC
	1200 1300 1500 1600		05.73 09.74 09.75 12.75	06.86 06.86 06.85 06.85		BAR11115		253 10,0 9,0
<b>Classic PKW LANCIA DEDRA (90-93)</b>								
	1.6 i.e. 1.6 i.e. 1.6 i.e. 1.8 i.e. 1.9 TD 2.0 i.e. 2.0 TD	66	01.90 01.90 02.93 01.90 01.90 01.90 01.90	01.93 01.93 10.93 10.93 10.93 10.93 10.93	- ABS + ABS	BA2033 BA2034		21100 17,0 +/-WK/S LUC 20833 17,1 +/-WK/S LUC
	1.6 i.e. 1.6 i.e. 1.8 i.e. 1.9 TD 2.0 TD	66	01.90 01.90 02.93 01.90 01.90	01.93 01.93 10.93 10.93 10.93	- ABS + ABS	BAR11119 BAR12127		240 11,0 9,2 257 12,0 10,2
	2.0 i.e.		01.90	10.93		BAR20142		258 20,0 18,2 V L





















<sup>1)</sup> 10" brake / servofreno da 10" / frein de 10" / freno de 10"

<sup>2)</sup> - heavy duty brake / - freno rinforzato / - frein renforcé / - freno reforzado























<sup>3)</sup> + heavy duty brake / + freno rinforzato / + frein renforcé / + freno reforzado





















<sup>4)</sup> to change only by pairs / sostituire solo a coppie / à changer seulement par paires / cambiar solamente por parejas

















<sup>5)</sup> 9"br./to change only by pairs / servofr.9"/sosti.solo coppie / fr.d.9"/chang.seulem.p.paires / fr.de 9"/camb.solam.p.paires















								
<b>Classic PKW LANCIA DEDRA (90-93)</b>								
	1.6 i.e. 1.8 i.e. 1.9 TD 2.0 i.e. 2.0 i.e. Turbo 2.0 Integrale 2.0 TD	66	01.90 01.90 01.90 01.90 05.91 09.91 01.90	10.93 + ABS 10.93 10.93 10.93 10.93 10.93 10.93	BA2035			21103 14,4 /S LUC
	1.6 i.e. 1.8 i.e. 1.9 TD 2.0 i.e. 2.0 i.e. Turbo 2.0 Integrale 2.0 TD	66	01.90 01.90 01.90 01.90 05.91 09.91 01.90	10.93 + ABS 10.93 10.93 10.93 10.93 10.93 10.93	BAR11119			240 11,0 9,2
<b>Classic PKW LANCIA DELTA (79-86)</b>								
	1300 1500	262991 262991	06.86 06.86		BAW1902			Rz 19,05
<b>Classic PKW LANCIA DELTA (86-93)</b>								
	2.0 i.e. 16V 2.0 i.e. 16V Turbo		07.86 07.86	12.91 12.91	BAR22147			284 22,0 20,2 V
	1.3 1.5 2.0 TD		07.86 07.86 07.86	10.93 10.93 10.93	BAW1902			Rz 19,05
<b>Classic PKW LANCIA PRISMA (83-86)</b>								
	1.9 TD 1300 1500	3032273 3032273	06.85 06.86 06.86		BAW1902			Rz 19,05
<b>Classic PKW LANCIA PRISMA (86-89)</b>								
	1.3 1.5 1.9 TD		07.86 07.86 07.86	06.89 06.89 06.89	BAW1902			Rz 19,05
<b>Classic PKW LANCIA THEMA (89-92)</b>								
	2.0 i.e. 16V Turbo 2.0 i.e. Turbo		10.89 02.89	09.92 - gepanzerte Fahrzeuge 1) 09.92 - gepanzerte Fahrzeuge 1)	BAR22147			284 22,0 20,2 V
<b>Classic PKW LAND ROVER RANGE ROVER I (70-94)</b>								
	2.4 D 3.5 3.5 VOGUE 3.9 KAT 3.9 VOGUE 4.3 VOGUE LSE	78 (V)GA399973 107 (V)GA399973 120 (V)GA399973 127 (V)GA399973 134 (V)GA399973 149	12.90 09.90 09.90 07.94 07.94 09.92		BA2187			21459 18,5 +/-WK AP
<b>Classic PKW MAZDA 626 Limousine/Coupe (87-91)</b>								
	1.6 (GD1) 1.8 (GD1) 2.0 (GD1) 2.0 (GD7) 2.0 D (GD1) 2.2 12V (GD1) 2.2 12V (GD7) 2.2 12V 4WD (GD1)		09.87 09.87 09.87 09.87 09.87 09.87 09.87 09.87	08.91 08.91 08.91 08.91 08.91 08.91 08.91 08.91	BA2110			21378 15,0 +/-WK AKE
<b>Classic PKW MERCEDES BENZ (R107) 280 SL-560 SL (71-89)</b>								
	280 SL 280 SLC 350 SL 350 SLC 450 SL 450 SLC 450 SLC 5.0 500 SLC	009600 005716	007869 008365 062584 030280 001627 001627	09.74 09.74 02.80 02.80 03.73 03.73 04.78 05.78		BAV1004	4	Warnkontakt L=94mm
	280 SL 280 SLC 380 SL 380 SLC 450 SL 450 SLC 450 SLC 5.0 500 SL 500 SLC	007870 008366 062585 030281 001628 001628		07.85 03.80 03.80 03.80 09.80 09.80 02.80 05.80 07.81		BAV1004	4	Warnkontakt L=94mm
	300 SL 420 SL 500 SL 560 SL			09.85 09.85 09.85 08.85	08.89 08.89 08.89 07.89 + USA ↓ AUS	BAV1004	4	Warnkontakt L=94mm

1) - armoured vehicles / - veicoli blindati / - véhicules blindés / - vehículo blindado

								
<b>Classic PKW MERCEDES BENZ (R107) 280 SL-560 SL (71-89)</b>								
	300 SL 420 SL 500 SL 560 SL		09.85 09.85 09.85 08.85	08.89 08.89 08.89 07.89		BAH0009	2	L=340
	280 SL 280 SLC 350 SL 350 SLC 450 SL 450 SLC 450 SLC 5.0 500 SLC	006644 007435 014752 013627 058150 028254 001199 001199	09.74 09.74 02.71 09.71 03.73 03.73 04.78 05.78			BA2162		21035 15,5 ATE
	280 SL 280 SLC 300 SL 350 SL 350 SLC 380 SLC		09.74 09.74 09.85 02.71 09.71 03.80	07.85 03.80 08.89 02.80 02.80 08.81		BAR10185		279 10,0 8,3
	280 SL 280 SLC 300 SL 350 SL 350 SLC		09.74 09.74 09.85 04.73 04.73	07.85 03.80 08.89 02.80 02.80		BAH0004	2	L=280
<b>Classic PKW MERCEDES BENZ (R113) 230 SL-280 SL (63-71)</b>								
	250 SL 280 SL		11.66 11.67	01.68 03.71		BA2162		21035 15,5 ATE
	250 SL 280 SL		11.66 11.67	01.68 03.71		BAR10185		279 10,0 8,3
<b>Classic PKW MERCEDES BENZ (R129) SL-Klasse (89-93)</b>								
	300 SL 300 SL 24 500 SL 600 SL V12		06.89 06.89 06.89 06.92	07.93 07.93 07.93 07.93		BA2182 BAV1004	4	21153 17,5 /WE Warnkontakt L=94mm ATE
	300 SL 300 SL 24 500 SL 600 SL V12		06.89 06.89 06.89 06.92	07.93 07.93 07.93 07.93		BAH0009	2	L=340
	300 SL 300 SL 24 500 SL 600 SL V12		06.89 06.89 06.89 06.92	07.93 07.93 07.93 07.93		BA2161 BAV1004	4	21197 15,0 /WE Warnkontakt L=94mm ATE
	300 SL 300 SL 24 500 SL 600 SL V12		06.89 06.89 06.89 06.92	07.93 07.93 07.93 07.93		BA2163 BAV1004 BAH0004	4 2	21305 15,5 /WE Warnkontakt L=94mm L=280 ATE
<b>Classic PKW MERCEDES BENZ (W108) 250 S-300 SEb (65-72)</b>								
	250 S 250 SE 280 S 280 SE 280 SE/SEL 3.5 280 SEL 300 SEb		07.65 08.65 11.67 11.67 03.71 01.68 08.65	03.69 01.68 09.72 09.72 08.72 03.71 12.67		BA2162		21035 15,5 ATE
	250 S 250 SE 280 S 280 SE 280 SE/SEL 3.5 280 SEL 300 SEb		07.65 08.65 11.67 11.67 03.71 01.68 08.65	03.69 01.68 09.72 09.72 08.72 03.71 12.67		BAR10185		279 10,0 8,3
<b>Classic PKW MERCEDES BENZ (W109) 300 SEL (65-72)</b>								
	300 SEL 300 SEL 2.8 300 SEL 3.5 300 SEL 6.3		08.65 12.67 09.69 12.67	11.67 01.70 09.72 09.72		BA2162		21035 15,5 ATE
	300 SEL 300 SEL 2.8 300 SEL 3.5 300 SEL 6.3		08.65 12.67 09.69 12.67	11.67 01.70 09.72 09.72		BAR10185		279 10,0 8,3

								
<b>Classic PKW MERCEDES BENZ (W111) 220-280 (59-71)</b>								
	250 SE/C 280 SE/C 280 SE/C 3.5		08.65 11.67 08.69	12.67 05.71 06.71	BA2162			21035 15,5 ATE
	250 SE/C 280 SE/C 280 SE/C 3.5		08.65 11.67 08.69	12.67 05.71 06.71	BAR10185			279 10,0 8,3
<b>Classic PKW MERCEDES BENZ (W114) 230.6-280 CE (67-76)</b>								
	230.6 250 250 C 280 280 C 280 CE 280 E	203607		10.76 06.72 06.72 04.72 06.72 04.72 04.72				278 12,6 10,6
	230.6 250 250 C 250 CE 280 280 C 280 CE 280 E		09.67 07.67 10.68 10.68 04.72 06.72 04.72 04.72	10.76 06.76 06.76 04.72 09.76 07.76 07.76 09.76	BA2162			21035 15,5 ATE
	230.6 250 250 C 250 CE 280 280 C 280 CE 280 E		09.67 07.67 10.68 10.68 04.72 06.72 04.72 04.72	10.76 06.76 06.76 04.72 09.76 07.76 07.76 09.76	BAR10185			279 10,0 8,3
	230.6 250 250 C 280 280 C 280 CE 280 E		04.73 04.73 04.73 04.73 04.73 04.73 04.73	10.76 06.76 06.76 09.76 07.76 07.76 09.76	BAH0004	2		L=280
<b>Classic PKW MERCEDES BENZ (W115) 200-240 D 3,0 (67-76)</b>								
	240 D 3.0		09.74	10.76	BAR13137			278 12,6 10,6
	200 200 D 220 220 D 230.4 240 D 240 D 3.0		10.67 10.67 10.67 07.67 08.73 08.73 09.74	12.76 12.76 07.73 11.76 11.76 11.76 10.76	BA2162			21035 15,5 ATE
	200 200 D 220 220 D 230.4 240 D 240 D 3.0		10.67 10.67 10.67 07.67 08.73 08.73 09.74	12.76 12.76 07.73 11.76 11.76 11.76 10.76	BAR10185			279 10,0 8,3
	200 200 D 220 220 D 230.4 240 D 240 D 3.0		04.73 04.73 04.73 04.73 08.73 08.73 09.74	12.76 12.76 07.73 11.76 11.76 11.76 10.76	BAH0004	2		L=280
<b>Classic PKW MERCEDES BENZ (W116) 280 S-450 SEL 6,9 (72-80)</b>								
	280 S 280 SE 280 SEL 350 SE 350 SEL 450 SE 450 SEL 450 SEL 6.9		09.72 08.72 01.74 09.72 11.73 11.72 03.73 05.75	07.80 07.80 04.80 03.80 01.80 04.80 09.80 09.80	BAV1004	4		Warnkontakt L=94mm
	280 S 280 SE 280 SEL 350 SE 350 SEL 450 SE 450 SEL 450 SEL 6.9		09.72 08.72 01.74 09.72 11.73 11.72 03.73 05.75	07.80 07.80 04.80 03.80 01.80 04.80 09.80 09.80	BA2162			21035 15,5 ATE

								
<b>Classic PKW MERCEDES BENZ (W116) 280 S-450 SEL 6,9 (72-80)</b>								
	280 S 280 SE 280 SEL 350 SE 350 SEL 450 SE 450 SEL 450 SEL 6.9		09.72 07.80 08.72 07.80 01.74 04.80 09.72 03.80 11.73 01.80 11.72 04.80 03.73 09.80 05.75 09.80		BAR10185			279 10,0 8,3
	280 S 280 SE 280 SEL 350 SE 350 SEL 450 SE 450 SEL 450 SEL 6.9		04.73 07.80 04.73 07.80 01.74 04.80 04.73 03.80 11.73 01.80 04.73 04.80 03.73 09.80 05.75 09.80		BAH0004	2		L=280
<b>Classic PKW MERCEDES BENZ (W123) 200-300 TD Turbo (76-85)</b>								
	200 200 D 220 D 230 230 C 230 T 240 D 240 TD 250 250 T 280 280 C 280 CE 280 E 280 TE 300 D 300 TD		01.76 07.79 01.76 07.79 01.76 01.79 01.76 07.79 03.77 07.79 04.78 07.79 01.76 07.79 02.78 07.79 01.76 07.79 04.78 07.79 01.76 07.79 03.77 07.79 01.76 07.79 04.78 07.79 01.76 07.79 04.78 07.79 01.76 07.79		BAV1004	4		Warnkontakt L=94mm
	200 200 D 200 T 230 230 C 230 CE 230 E 230 T 230 TE 240 D 240 TD 250 250 T 280 280 C 280 CE 280 E 280 TE 300 D 300 TD 300 TD Turbo		08.79 09.85 08.79 03.85 11.80 12.85 08.79 02.81 08.79 04.80 06.80 07.85 06.80 09.85 08.79 04.80 06.80 12.85 08.79 07.85 08.79 12.85 08.79 07.85 08.79 08.82 08.79 07.81 08.79 03.80 08.79 07.85 08.79 09.85 08.79 12.85 08.79 07.85 08.79 12.85 08.80 12.85		BAV1004	4		Warnkontakt L=94mm
	200 200 D 200 T 220 D 230 230 C 230 CE 230 E 230 T 230 TE 240 D 240 TD 250 250 T 280 280 C 280 CE 280 E 280 TE 300 D 300 TD 300 TD Turbo		01.76 09.85 01.76 03.85 11.80 12.85 01.76 01.79 01.76 02.81 03.77 04.80 06.80 07.85 06.80 09.85 04.78 04.80 06.80 12.85 01.76 07.85 02.78 12.85 01.76 07.85 04.78 08.82 01.76 07.81 03.77 03.80 03.77 07.85 01.76 09.85 04.78 12.85 01.76 07.85 04.78 12.85 08.80 12.85		BAR13137			278 12,6 10,6
	200 200 D 200 T 230 230 C 230 CE 230 E 230 T 230 TE	126116 179857  158356 015331  004327	09.85 03.85 11.80 12.85 02.81 02.81 06.80 07.85 06.80 09.85 04.80 12.85		BAH0009	2		L=340
			06.80 12.85					

Classic PKW MERCEDES BENZ (W123) 200-300 TD Turbo (76-85)									
									
	240 D 240 TD 250 250 T 280 280 C 280 CE 280 E 280 TE 300 D 300 TD 300 TD Turbo	150315 007371 079229 003286 027814 003417 017059 064177 004196 165148 011093		07.85 12.85 07.85 08.82 07.81 03.80 07.85 09.85 12.85 07.85 12.85 08.80 12.85		BAH0009	2		L=340
	200 200 D 220 D 230 230 C 230 CE 230 E 240 D 250 280 280 C 280 CE 280 E 300 D			01.76 09.85 01.76 03.85 01.76 01.79 01.76 02.81 03.77 04.80 06.80 07.85 06.80 09.85 01.76 07.85 01.76 07.85 01.76 07.81 03.77 03.80 03.77 07.85 01.76 09.85 01.76 07.85		BA2162			21035 15,5 ATE
	200 200 D 200 T 220 D 230 230 C 230 CE 230 E 230 T 230 TE 240 D 240 TD 250 250 T 280 280 C 280 CE 280 E 280 TE 300 D 300 TD 300 TD Turbo			01.76 09.85 01.76 03.85 11.80 12.85 01.76 01.79 01.76 02.81 03.77 04.80 06.80 07.85 06.80 09.85 04.78 04.80 06.80 12.85 01.76 07.85 02.78 12.85 01.76 07.85 04.78 08.82 01.76 07.81 03.77 03.80 03.77 07.85 01.76 09.85 04.78 12.85 01.76 07.85 04.78 12.85 08.80 12.85		BAR10185			279 10,0 8,3
	200 200 D 200 T 220 D 230 230 C 230 CE 230 E 230 T 230 TE 240 D 240 TD 250 250 T 280 280 C 280 CE 280 E 280 TE 300 D 300 TD 300 TD Turbo			01.76 09.85 01.76 03.85 11.80 12.85 01.76 01.79 01.76 02.81 03.77 04.80 06.80 07.85 06.80 09.85 04.78 04.80 06.80 12.85 01.76 07.85 02.78 12.85 01.76 07.85 04.78 08.82 01.76 07.81 03.77 03.80 03.77 07.85 01.76 09.85 04.78 12.85 01.76 07.85 04.78 12.85 08.80 12.85		BAH0004	2		L=280
Classic PKW MERCEDES BENZ (W124) E-Klasse (85-93)									
	200 200 CE 200 D 200 E 220 CE 220 E 230 CE 230 E 250 D 250 D Turbo 260 E 260 E 4-Matic 280 E 300 CE 300 D			01.85 02.90 04.90 06.93 01.85 06.93 01.85 06.93 10.92 06.93 10.92 06.93 05.87 09.92 01.85 09.92 01.85 06.93 09.88 06.93 01.85 09.92 05.85 08.91 10.92 06.93 + Radstand 2800mm <sup>1)</sup> 05.87 09.92 01.85 06.93		BA2029 BAV1001	2		20941 19,3 /WE/S LUC Warnkontakt L=68(170)mm
									

<sup>1)</sup> + wheel base 2800 mm / + passo 2800 mm / + empattement 2800 mm / + distancia entre ejes 2800 mm

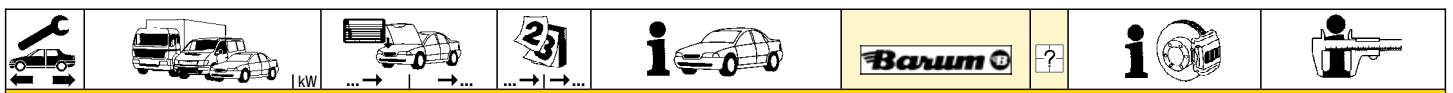















**Classic PKW MERCEDES BENZ (W124) E-Klasse (85-93)**

	300 D 4-Matic 300 D Turbo 300 E 300 E 4-Matic		12.86 08.91 09.87 06.93 01.85 09.92 11.86 06.93		BA2029 BAV1001	2		20941 19,3 /WE/S Warnkontakt L=68(170)mm	LUC
	200 T 200 TD 200 TE 220 TE 230 E Kombi 230 TE 250 D Kombi 250 TD 250 TD Turbo 260 E Kombi 280 TE 300 TD 300 TD Turbo 300 TD Turbo 4-Matic 300 TE 300 TE 4-Matic		10.85 02.90 10.85 08.91 10.88 06.93 10.92 06.93 01.85 09.92 + Spezialaufbau 1) 10.85 09.92 10.85 06.93 + Spezialaufbau 1) 10.85 06.93 04.90 06.93 + ⓘ 10.85 09.92 + Spezialaufbau 1) 10.92 06.93 04.86 06.93 10.85 06.93 03.87 06.93 10.85 09.92 11.86 06.93		BA2029 BAV1001	2		20941 19,3 /WE/S Warnkontakt L=68(170)mm	LUC
	280 E 280 E Kombi 300 CE 24 Cabrio 300 CE 24 Coupe 300 E 24 300 TE 24 320 CE 320 E 320 TE 400 E 500 E	B884946 F242721     B862121 B864307 F242721  B938569	10.92 10.92 01.92 06.93 09.89 09.92 09.89 09.92 09.89 09.92 10.92 10.92 10.92 06.93 01.91 06.93	+ Radstand 3600mm 2) + Spezialaufbau 1)	BA2182 BAV1004	4		21153 17,5 /WE Warnkontakt L=94mm	ATE
	280 E 280 E Kombi 320 CE 320 E 320 TE 400 E	B884947 F242722 B862122 B864308 F242722  B938568	06.93 06.93 06.93 06.93 06.93 10.92	+ Radstand 3600mm 2) + Spezialaufbau 1)	BAV1004	4		Warnkontakt L=94mm	
	200 200 CE 200 D 200 E 200 T 200 TD 200 TE 230 CE 230 E 230 E 230 E Kombi 230 TE 250 D 250 D Kombi 250 TD 300 D 300 TD	A323451      A797178 A805931 A279007 F081909 F081909	01.85 02.90 04.90 09.92 01.85 06.93 01.85 09.92 10.85 02.90 10.85 08.91 10.88 09.92 05.87 01.85 01.85 10.85 01.85 06.93 10.85 06.93 + Spezialaufbau 1) 10.85 06.93 01.85 06.93 04.86 06.93	+ Spezialaufbau 1)	BAR12117			284 12,0 10,0 L	
	alle Typen		01.85 06.93		BAH0009	2		L=340	
	200 200 CE 200 D 200 E 220 CE 220 E 230 CE 230 E 250 D 250 D Turbo 260 E 260 E 4-Matic 280 E 300 CE 300 D 300 D 4-Matic 300 D Turbo 300 E 300 E 4-Matic		01.85 02.90 04.90 06.93 01.85 06.93 01.85 06.93 10.92 06.93 10.92 06.93 05.87 09.92 01.85 09.92 01.85 06.93 + Radstand 2800mm 3) 09.88 06.93 01.85 09.92 - ASR/ + Radstand 2800mm 4) 05.85 08.91 10.92 06.93 - ASR/ + Radstand 2800mm 4) 05.87 09.92 - ASR 01.85 06.93 12.86 08.91 09.87 06.93 01.85 09.92 - ASR 11.86 06.93	+ Radstand 2800mm 3) - ASR/ + Radstand 2800mm 4)	BA2094			20687 15,5	ATE
	200 T 200 TD 200 TE 220 TE 230 E Kombi 230 TE 250 D 250 D Kombi 250 TD 250 TD Turbo		10.85 02.90 10.85 08.91 10.88 06.93 10.92 06.93 01.85 09.92 + Spezialaufbau 1) 10.85 09.92 01.90 06.93 + Radstand 3600mm 2) 10.85 06.93 + Spezialaufbau 1) 10.85 06.93 04.90 06.93 + ⓘ	+ Radstand 3600mm 2)	BA2161 BAV1004	4		21197 15,0 /WE Warnkontakt L=94mm	ATE

1) + special body / + carrozzeria speciale / + carrosserie spéciale / + construcc.carroceria especial  
 2) + wheel base 3600 mm / + passo 3600 mm / + empattement 3600 mm / + distancia entre ejes 3600 mm  
 3) + wheel base 2800 mm / + passo 2800 mm / + empattement 2800 mm / + distancia entre ejes 2800 mm  
 4) - ASR/ + wheel base 2800mm / - ASR/+ passo 2800mm / - ASR/+ empattement 2800mm / - ASR/+ dist.entre ejes 2800mm

















											
<b>Classic PKW MERCEDES BENZ (W124) E-Klasse (85-93)</b>											
	260 E		01.90	09.92	+ Radstand 3600mm <sup>1)</sup>	BA2161		21197 15,0 /WE Warnkontakt L=94mm	ATE		
	260 E Kombi		10.85	09.92	+ Spezialaufbau <sup>2)</sup>	BAV1004	4				
	280 TE		10.92	06.93							
	300 CE 24 Cabrio		01.92	06.93							
	300 CE 24 Coupe		09.89	09.92							
	300 E 24		09.89	09.92							
	300 TD		04.86	06.93							
	300 TD Turbo		10.85	06.93							
	300 TD Turbo 4-Matic		03.87	06.93							
	300 TE		10.85	09.92							
300 TE 4-Matic		11.86	06.93								
320 CE		10.92	06.93								
320 E		10.92	06.93								
260 E		09.89	09.92	+ ASR/ + Radstand 2800mm <sup>3)</sup>	BAV1004	4		Warnkontakt L=94mm			
280 E		10.92	06.93	+ ASR/ + Radstand 2800mm <sup>3)</sup>							
300 CE		09.89	09.92	+ ASR							
300 E		09.89	09.92	+ ASR							
280 E		10.92	06.93	+ Radstand 3600mm <sup>1)</sup>	BA2161		4	21197 15,0 /WE Warnkontakt L=94mm	ATE		
280 E Kombi		10.92	06.93	+ Spezialaufbau <sup>2)</sup>	BAV1004						
300 TE 24		09.89	09.92								
320 TE		10.92	06.93								
400 E		10.92	06.93		BA2161		4	21197 15,0 /WE	ATE		
500 E		01.91			BAV1004			Warnkontakt L=94mm			
500 E	B927761		06.93		BA2163 BAV1004		4	21305 15,5 /WE	ATE		
								Warnkontakt L=94mm			
	200		01.85	02.90		BAR09118		258 9,0 7,3			
	200 CE		04.90	06.93							
	200 D		01.85	06.93							
	200 E		01.85	06.93							
	220 CE		10.92	06.93							
	220 E		10.92	06.93							
	230 CE		05.87	09.92							
	230 E		01.85	09.92							
	250 D		01.85	06.93	+ Radstand 2800mm <sup>4)</sup>						
	250 D Turbo		09.88	06.93							
	260 E		01.85	09.92	+ Radstand 2800mm <sup>4)</sup>						
	260 E 4-Matic		05.85	08.91							
	280 E		10.92	06.93	+ Radstand 2800mm <sup>4)</sup>						
	300 CE		05.87	09.92							
	300 D		01.85	06.93							
	300 D 4-Matic		12.86	08.91							
	300 D Turbo		09.87	06.93							
	300 E		01.85	09.92							
	300 E 4-Matic		11.86	06.93							
	200 T		10.85	02.90		BAR09114					278 9,0 7,3
200 TD		10.85	08.91								
200 TE		10.88	06.93								
220 TE		10.92	06.93								
230 E Kombi		01.85	06.93	+ Spezialaufbau <sup>2)</sup>							
230 TE		10.85	09.92								
250 D		01.90	06.93	+ Radstand 3600mm <sup>1)</sup>							
250 D Kombi		10.85	06.93	+ Spezialaufbau <sup>2)</sup>							
250 TD		10.85	06.93								
250 TD Turbo		04.90	06.93	+ 							
260 E		01.90	09.92	+ Radstand 3600mm <sup>1)</sup>							
260 E Kombi		10.85	06.93	+ Spezialaufbau <sup>2)</sup>							
280 TE		10.92	06.93								
300 CE 24 Cabrio		01.92	06.93								
300 CE 24 Coupe		09.89	09.92								
300 E 24		09.89	09.92								
300 TD		04.86	06.93								
300 TD Turbo		10.85	06.93								
300 TD Turbo 4-Matic		03.87	06.93								
300 TE		10.85	09.92								
300 TE 4-Matic		11.86	06.93								
320 CE		10.92	06.93								
320 E		10.92	06.93								
	alle Typen		01.85	06.93		BAH0004	2	L=280			
<b>Classic PKW MERCEDES BENZ (W126) 260 SE-560 SEC (80-91)</b>											
	280 S		01.80	07.85		BAV1004	4	Warnkontakt L=94mm			
	280 SE		01.80	07.85							
	280 SEL		05.80	07.85							
	380 SE		01.80	08.85							
	380 SEL		05.80	07.85							
	500 SE		01.80	08.85							
	500 SEL		05.80	08.85							
	260 SE		09.85	03.91		BAV1004	4			Warnkontakt L=94mm	
	300 SE		09.85	03.91							
	300 SEL		09.85	03.91							
420 SE		09.85	03.91								
420 SEC		09.85	08.91								
420 SEL		09.85	03.91								
500 SE		09.85	03.91								

















1) + wheel base 3600 mm / + passo 3600 mm / + empattement 3600 mm / + distancia entre ejes 3600 mm

2) + special body / + carrozzeria speciale / + carrosserie spéciale / + construcc. carroceria especial

3) + ASR/ + wheel base 2800mm / + ASR/ + passo 2800mm / + ASR/ + empattement 2800mm / + ASR/ + dist. entre ejes 2800 mm























4) + wheel base 2800 mm / + passo 2800 mm / + empattement 2800 mm / + distancia entre ejes 2800 mm

								
<b>Classic PKW MERCEDES BENZ (W126) 260 SE-560 SEC (80-91)</b>								
	500 SEC 500 SEL 560 SE 560 SEC 560 SEL		09.85 08.91 09.85 03.91 07.88 03.91 09.85 08.91 09.85 03.91		BAV1004	4		Warnkontakt L=94mm
	260 SE 300 SE 300 SEL 420 SE 420 SEC 420 SEL 500 SE 500 SEC 500 SEL 560 SE 560 SEC 560 SEL		09.85 03.91 09.85 03.91 09.85 03.91 09.85 03.91 09.85 08.91 09.85 03.91 09.85 03.91 09.85 08.91 09.85 03.91 09.85 03.91 07.88 03.91 09.85 08.91 09.85 03.91		BAR28102			300 28,0 25,4 V L
	260 SE 280 S 280 SE 280 SEL 300 SE 300 SEL 380 SE 380 SEC 380 SEL 420 SE 420 SEC 420 SEL 500 SE 500 SEC 500 SEL 560 SE 560 SEC 560 SEL		09.85 03.91 01.80 07.85 01.80 07.85 05.80 07.85 09.85 03.91 09.85 03.91 01.80 08.85 06.81 07.85 05.80 07.85 09.85 03.91 09.85 08.91 09.85 03.91 01.80 03.91 06.81 08.91 05.80 03.91 07.88 03.91 09.85 08.91 09.85 03.91		BAH0009	2		L=340
	260 SE 280 S 280 SE 280 SEL 300 SE 300 SEL 380 SE 380 SEC 380 SEL 420 SE 420 SEC 420 SEL 500 SE 500 SEC 500 SEL 560 SE 560 SEC 560 SEL		09.85 03.91 01.80 07.85 01.80 07.85 05.80 07.85 09.85 03.91 09.85 03.91 01.80 08.85 06.81 07.85 05.80 07.85 09.85 03.91 09.85 08.91 09.85 03.91 01.80 03.91 06.81 08.91 05.80 03.91 07.88 03.91 09.85 08.91 09.85 03.91		BAV1004	4 + ASR		Warnkontakt L=94mm
	260 SE 280 S 280 SE 280 SEL 300 SE 300 SEL 380 SE 380 SEC 380 SEL 420 SE 420 SEC 420 SEL		09.85 03.91 01.80 07.85 01.80 07.85 05.80 07.85 09.85 03.91 09.85 03.91 01.80 08.85 06.81 07.85 05.80 07.85 09.85 03.91 09.85 08.91 09.85 03.91		BAR10185			279 10,0 8,3
	500 SE 500 SEC 500 SEL 560 SE 560 SEC 560 SEL		01.80 03.91 06.81 08.91 05.80 03.91 07.88 03.91 09.85 08.91 09.85 03.91		BAR10185			279 10,0 8,3
	260 SE 280 S 280 SE 280 SEL 300 SE 300 SEL 380 SE 380 SEC 380 SEL 420 SE 420 SEC 420 SEL		09.85 03.91 01.80 07.85 01.80 07.85 05.80 07.85 09.85 03.91 09.85 03.91 01.80 08.85 06.81 07.85 05.80 07.85 09.85 03.91 09.85 08.91 09.85 03.91		BAH0004	2		L=280



























												
<b>Classic PKW MERCEDES BENZ (W201) 190-190 E 2,6 (82-93)</b>												
	190		04.82	02.90	BA2027 BAV1001	2		21055 16,9 /WE/S LUC Warnkontakt L=68(170)mm				
	190 D		09.83	05.93								
	190 D 2.2		09.83	09.85 + USA								
	190 D 2.5		05.85	05.93								
	190 D 2.5 Turbo		11.87	05.93								
	190 E 1.8		03.90	05.93								
	190 E 2.0		04.82	05.93								
	190 E 2.3		09.83	05.93								
	190 E 2.6		04.86	05.93								
190 E 2.3 16V		07.84	08.88	BA2029	2		20941 19,3 /WE/S LUC Warnkontakt L=68(170)mm					
190 E 2.5 16V		09.88	05.93	BAV1001								
190 E 2.5 16V Evolut.	173	03.89	05.93	BA2182 BAV1004				4	21153 17,5 /WE ATE Warnkontakt L=94mm			
	190		04.82	02.90	BAR11137			262 10,9 9,0				
	190 D		09.83	05.93								
	190 D 2.2		09.83	09.85 + USA								
	190 D 2.5		05.85	05.93								
	190 E 1.8		03.90	05.93								
	190 E 2.0		04.82	05.93								
	190		04.82	02.90					BAH0009	2		L=340
	190 D		09.83	05.93								
	190 D 2.2		09.83	09.85 + USA								
190 D 2.5		05.85	05.93									
190 D 2.5 Turbo		11.87	05.93									
190 E 1.8		03.90	05.93									
190 E 2.0		04.82	05.93									
190 E 2.3		09.83	05.93									
190 E 2.3 16V		07.84	08.88									
190 E 2.5 16V		09.88	05.93	BA2094		20687 15,5 ATE						
190 E 2.5 16V Evolut.	173	03.89	05.93									
190 E 2.6		04.86	05.93									
	190		04.82	02.90	BAV1004 BA2093	4	+ ASR - ASR	Warnkontakt L=94mm 20687 13,5 ATE				
	190 D		09.83	05.93								
	190 D 2.2		09.83	09.85 + USA								
	190 D 2.5		05.85	05.93								
	190 D 2.5 Turbo		11.87	05.93								
	190 E 1.8		03.90	05.93								
	190 E 2.0		04.82	05.93								
	190 E 2.3		09.83	05.93								
	190 E 2.6		04.86	05.93								
190 E 2.3 16V		07.84	08.88	BA2094		20687 15,5 ATE						
190 E 2.5 16V		09.88	05.93									
190 E 2.5 16V Evolut.	173	03.89	05.93									
	190		04.82	02.90	BAR09118			258 9,0 7,3				
	190 D		09.83	05.93								
	190 D 2.2		09.83	09.85 + USA								
	190 D 2.5		05.85	05.93								
	190 D 2.5 Turbo		11.87	05.93								
	190 E 1.8		03.90	05.93								
	190 E 2.0		04.82	05.93								
	190 E 2.3		09.83	05.93								
	190 E 2.3 16V		07.84	08.88								
190 E 2.5 16V		09.88	05.93	BAH0004	2		L=280					
190 E 2.6		04.86	05.93									
190		04.82	02.90									
	190 D		09.83	05.93								
	190 D 2.2		09.83	09.85 + USA								
	190 D 2.5		05.85	05.93								
	190 D 2.5 Turbo		11.87	05.93								
	190 E 1.8		03.90	05.93								
	190 E 2.0		04.82	05.93								
	190 E 2.3		09.83	05.93								
	190 E 2.3 16V		07.84	08.88								
	190 E 2.5 16V		09.88	05.93								
190 E 2.5 16V Evolut.	173	03.89	05.93									
190 E 2.6		04.86	05.93									
<b>Classic PKW MERCEDES BENZ G-Klasse (W460) (79-93)</b>												
	200 GE		05.86	+ ①	BA2101 BAV1004 BAV1032	4 2	VA: -H000247 ① VA: H000248- ②	20784 18,0 /WE ATE Warnkontakt L=94mm Warnkontakt L=260mm				
	230 G		02.79	08.85								
	230 GE		04.82									
	240 GD		02.79									
	250 GD		08.87									
	280 GE		02.79									
	300 GD		02.79									
<b>Classic PKW MERCEDES BENZ G-Klasse (W461) (90-)</b>												
	230 GE		02.93		BA2101 BAV1032	2		20784 18,0 /WE ATE Warnkontakt L=260mm				
	250 GD		02.90									
	290 GD		04.92									
	G 290 TD		07.97									
	G 320 CDI	135	02.09						BAV1032	2		Warnkontakt L=260mm
G 350 CDI	135	04.10										

1) FA: -H000247 / A: -H000247 / ess. AV: -H000247 / ED: -H000247

















2) FA: H000248- / A: H000248- / ess. AV: H000248- / ED: H000248-

									
<b>Classic PKW MERCEDES BENZ G-Klasse (W461) (90-)</b>									
	G 320 CDI	135		02.09		BA2216 BAV1008	2	23021 18,9 /WE Warnkontakt L=185mm	<b>BOS</b>
	G 320 CDI	135		02.09		BAR16110		272 16,0 14,0 L	
<b>Classic PKW MERCEDES BENZ Transporter (BM 601) 207 D-210 D</b>									
	207 D 208 208 D 209 D 210 210 D			05.77 05.77 09.88 05.77 05.77 09.88		BA2101 BAV1004	4	20784 18,0 /WE Warnkontakt L=94mm	<b>ATE</b>
	207 D 208 208 D 209 D 210 210 D			05.77 05.77 09.88 05.77 05.77 09.88		BAR16100		280 16,0 13,0	
<b>Classic PKW MERCEDES BENZ Transporter (BM 602) 307 D-310 D</b>									
	307 D 308 308 D 309 D 310 310 D			05.77 05.77 09.88 05.77 05.77 09.88		BA2101 BAV1004	4	20784 18,0 /WE Warnkontakt L=94mm	<b>ATE</b>
	307 D 308 308 D 309 D 310 310 D		VA:A025460	05.77 05.77 09.88 05.77 05.77 09.88		BAR16100		280 16,0 13,0	
<b>Classic PKW MERCEDES BENZ Transporter (BM 611) 407 D-410 D</b>									
	407 D 408 D 409 D 410 410 D			06.81 10.88 06.81 06.81 11.88		BA2101 BAV1004	4	20784 18,0 /WE Warnkontakt L=94mm	<b>ATE</b>
	407 D 408 D 409 D 410 410 D		VA:A025460	06.81 10.88 06.81 06.81 11.88		BAR16100		280 16,0 13,0	
<b>Classic PKW MERCEDES BENZ Transporter (BM 667) 507 D-510</b>									
	507 D 508 D 508 DK 510			03.86 05.90 05.90 03.86		BA2101 BAV1004	4	20784 18,0 /WE Warnkontakt L=94mm	<b>ATE</b>
	507 D 508 D 508 DK 510		VA:A025460	03.86 05.90 05.90 03.86		BAR16100		280 16,0 13,0	
<b>Classic PKW MERCEDES BENZ Transporter (BM 668) 609 D</b>									
	609 D			03.86		BA2124 BAV1033	2	29835 22,0 /WE WK Satz L=239/180mm	<b>ATE</b>
<b>Classic PKW MERCEDES BENZ Transporter (BM 669) 709 D/711 D</b>									
	709 D 711 D			03.86 03.86		BA2124 BAV1033	2	29835 22,0 /WE WK Satz L=239/180mm	<b>ATE</b>
<b>Classic PKW MERCEDES BENZ Transporter (BM 670) 809 D-814 D</b>									
	809 D 811 D 811 DK 814 D			03.86 03.86 06.90 03.86		BA2124 BAV1033	2	29835 22,0 /WE WK Satz L=239/180mm	<b>ATE</b>
<b>Classic PKW MITSUBISHI PAJERO (83-91)</b>									
	2.5 TD (L044G) 2.5 TD (L049G) 2.5 TD (L144G) 2.5 TD (L149G) 2.6 (L042G) 2.6 (L047G) 3.0 V6 (L141G) 3.0 V6 (L146G)			05.86 05.86 11.88 11.88 01.83 09.84 11.88 11.88	10.88 05.91 05.91 05.91 10.89 + Option Mod. NJL6/ VNJL6/ VNJR6 <sup>1)</sup> 10.89 05.91 05.91	BA2112		21373 16,0 +/-WK	<b>SUM</b>

<sup>1)</sup> + option mod. NJL6/ VNJL6/ VNJR6 / + opzione mod. NJL6/ VNJL6/ VNJR6 / + option mod. NJL6/ VNJL6/ VNJR6 / + opción mod. NJL6/ VNJL6/ VNJR6

								
<b>Classic PKW MITSUBISHI SAPPORO (87-90)</b>								
	2.4 (E16A)	91	06.87	06.90	BAR24136			256 24,0 21,5 V
<b>Classic PKW NISSAN SUNNY (B12) Coupe (86-90)</b>								
	1.6 i		02.87	09.88 + DOHC	BAR18107			240 18,0 16,0 V
<b>Classic PKW NISSAN SUNNY (B12) Kombi (86-90)</b>								
	1.5 1.6 i 1.6 i 4x4 1.7 D		06.86 06.86 06.86 06.86	09.88 12.90 12.90 12.90	BAR18107			240 18,0 16,0 V
<b>Classic PKW NISSAN SUNNY (N13) (86-90)</b>								
	1.6 i 1.6 i 4x4 1.7 D		02.87 06.86 06.86	09.88 + DOHC 12.90 12.90	BAR18107			240 18,0 16,0 V
<b>Classic PKW OPEL ASCONA B / Vauxhall Cavalier (75-81)</b>								
	1.3 1.6 2.0 2.0 D		03.79 03.79 03.79 03.79	07.81 + Faustsättel <sup>1)</sup> 07.81 + Faustsättel <sup>1)</sup> 07.81 + Faustsättel <sup>1)</sup> 07.81 + Faustsättel <sup>1)</sup>	BA2134			20939 15,4 /WE DEL
<b>Classic PKW OPEL ASCONA C / Vauxhall Cavalier (82-88)</b>								
	1.3 1.6 1.6 D 1.8		08.81 08.81 01.82 09.82	08.88 08.88 08.88 08.88 - belüftete Scheiben <sup>2)</sup>	BA2134			20939 15,4 /WE DEL
	1.8 i 2.0 i N 2.0 i S		09.82 10.87 10.87	08.88 + belüftete Scheiben <sup>3)</sup> 08.88 08.88	BA2134			20939 15,4 /WE DEL
	1.3 1.6 1.6 D 1.8		08.81 08.81 01.82 09.82	08.88 08.88 08.88 08.88 - belüftete Scheiben <sup>2)</sup>	BAR13161			236 12,7 10,7
	1.8 i 2.0 i N 2.0 i S		09.82 08.81 10.87	08.88 + belüftete Scheiben <sup>3)</sup> 08.88 08.88	BAR20115			236 20,0 17,0 V L
	1.3 1.6 1.6 D 1.8 2.0 i N 2.0 i S	G1001772 G1001772 G1001772 G1001772 G1001772		08.88 08.88 08.88 08.88 08.88	BAW1705			Rz 17,46 LUC
	1.3 1.6 1.6 D 1.8 2.0 i N 2.0 i S	G6000001 G6000001 G6000001 G6000001 G6000001		08.88 08.88 08.88 08.88 08.88	BAW1705			Rz 17,46 LUC
	2.0 i S		10.87	08.88	BAW1904	+ GG <sup>4)</sup>		Rz 19,05 LUC
<b>Classic PKW OPEL CORSA A / Vauxhall Nova (83-92)</b>								
	1.0 S 1.2 1.3 1.4 N 1.5 D 1.5 TD 1.6 i N 1.6 i SE		M4999999 M4999999 M4999999 M4999999 M4999999 M4999999 M4999999	09.82 09.82 09.82 08.89 09.87 03.88 03.88 01.88	BA2134			20939 15,4 /WE DEL
	1.0 S 1.2 1.4 i SE 1.4 N 1.5 D 1.5 TD 1.6 i N 1.6 i SE	N4000001 N4000001 N4000001 N4000001 N4000001 N4000001 N4000001		10.92 10.92 10.92 10.92 10.92 10.92 10.92	BA2136			20547 16,8 +/WE ATE
	1.0 S 1.2 1.3 1.4 N		M4999999 M4999999 M4999999 M4999999	09.82 09.82 09.82 08.89	BAR10152			236 10,0 7,0
	1.0 S 1.2 1.4 N 1.5 D 1.5 TD 1.6 i N	N4000001 N4000001 N4000001		10.92 10.92 10.92 09.87 03.88 03.88	BAR13161			236 12,7 10,7
	1.4 i SE 1.6 i N 1.6 i SE	N4000001 N4000001		10.92 10.92 01.88	BAR20115			236 20,0 17,0 V L

1) + fist type calipers / + pinza freno flottante / + étriers à griffe / + pinza de puno  
2) - ventilated discs / - dischi ventilati / - disques ventilés / - disco ventilado  
3) + ventilated discs / + dischi ventilati / + disques ventilés / + disco ventilado  
4) + cast iron / + ghisa / + fonte grise / + fundición de gris

											
<b>Classic PKW OPEL CORSA A / Vauxhall Nova (83-92)</b>											
	1.0 S 1.0 S 1.2 1.3 1.4 N 1.5 D 1.5 TD 1.6 i N 1.6 i SE	G4000001 M4000001 G4000001 G4000001 N4000000 G4000001 N4000001 N4000001 N4000001 N4000001			10.92 10.92 10.92 08.89 09.87 03.88 03.88 01.88	+ verstärkte Bremse <sup>1)</sup> - EG Vorschrift <sup>2)</sup>	BAW1705		Rz 17,46	LUC	
	1.0 1.2 1.3 1.4 1.5 D 1.5 TD 1.6	N4000001 N4000001 N4000001 N4000001 N4000001 N4000001 N4000001			10.92 10.92 10.92 10.92 10.92 10.92 10.92		BAE5005		200 x 29 HEB		
<b>Classic PKW OPEL KADETT D / Vauxhall Astra D (79-84)</b>											
	1.2 1.3 1.6 1.6 D 1.8				08.79 08.79 01.82 01.82 01.82	07.84 07.84 07.84 07.84 07.84		BA2134		20939 15,4 /WE	DEL
	1.2 1.3 1.3 1.6 1.6 D 1.8 i				08.79 08.79 08.79 01.82 01.82 01.82	07.84 07.84 07.84 07.84 07.84 07.84	- verstärkte Br./+ Schaltgetr. <sup>3)</sup> + verstärkte Bremse/+ Schaltgetr. <sup>4)</sup> + Automatikgetriebe <sup>5)</sup>	BAR10152 BAR13161 BAR20115		236 10,0 7,0 236 12,7 10,7 236 20,0 17,0 V L	
<b>Classic PKW OPEL KADETT E / Vau. Astra E/Belmont (84-93)</b>											
	1.2 1.3 1.4 1.5 TD 1.6 1.6 D 1.7 D				08.84 08.84 08.89 07.88 08.84 08.84 08.88	09.91 09.91 09.91 09.91 09.91 09.91 09.91		BA2134		20939 15,4 /WE	DEL
	1.8 Caravan 1.8 Caravan 1.8 Limousine 1.8 Limousine Combo	K5025260 K2500077 L5000000 L2500000			08.84 08.84 08.84 08.84	09.91 09.91 09.91 09.91		BA2134		20939 15,4 /WE	DEL
	1.8 Caravan 1.8 Caravan 1.8 Limousine 1.8 Limousine 2.0 i 2.0 i 16V	K2500078 K5025261 L2500001 L5000001			08.85 08.87	09.91 09.91		BA2137 BA2134		21190 17,5 +/WE 20939 15,4 /WE	ATE DEL
	1.2 1.3 1.4 1.2 1.3 1.4 1.5 TD 1.6 1.6 D 1.7 D 1.8 1.6 1.6 D 1.7 D 1.8 i 1.8 i 2.0 i 2.0 i 16V				08.84 08.84 08.89 08.84 08.84 08.84 08.84 08.88 08.84 08.84 08.88 08.84 08.84 08.88 08.84 08.85 08.87	09.91 09.91 09.91 09.91 09.91 09.91 09.91 09.91 09.91 09.91 09.91 09.91 09.91 09.91 09.91 09.91 09.91		BAR10152 BAR13161 BAR20115 BAR24115		236 10,0 7,0 236 12,7 10,7 236 20,0 17,0 V L 256 24,0 21,0 V L	
	2.0 i 16V Limousine				08.87	09.91		BA2098		21140 15,7	ATE
	diverse Typen Lim. diverse Typen Lim. diverse Typen Caravan diverse Typen Caravan	G2502697 G5000001 G2502697 G5000001			09.91 09.91 09.91 09.91			BAW1705 BAW1904 BAW1904	Bördel F <sup>6)</sup> + GG/ Bördel F <sup>7)</sup> + GG/ Bördel F/ - Druckbolzen <sup>8)</sup>	Rz 17,46 Rz 19,05 Rz 19,05	LUC LUC LUC
<b>Classic PKW OPEL MANTA B / Vauxhall Cavalier Coupe (76-88)</b>											
	1.2 1.3 1.6 1.8 2.0 Manta 400 i				09.78 01.80 09.78 01.82 09.78 08.81	12.88 12.86 12.82 12.88 12.88 07.86	+ Faustsättel <sup>9)</sup> + Faustsättel <sup>9)</sup> + Faustsättel <sup>9)</sup> + Faustsättel <sup>9)</sup> + Faustsättel <sup>9)</sup>	BA2134 BA2134		20939 15,4 /WE 20939 15,4 /WE	DEL DEL

<sup>1)</sup> + heavy duty brake / + freno rinforzato / + frein renforcé / + freno reforzado

<sup>2)</sup> - EC regulation / - normativa CEE / - prescription CEE / - según normativa CEE

<sup>3)</sup> - heavy duty br./+ manual trans. / - fr.rinforzato/+ scatola camb.velocità / - frein renforcé/ + transm.mécanique / - freno reforzado/ + camb.velocidad

<sup>4)</sup> + heavy duty br./+ manual transm. / + fr.rinforzato/+ scatola camb.velocità / + frein renforcé/ + transm.mécanique / + freno reforzado/ + camb.de velocidad





















<sup>5)</sup> + autom.transmission / + scatola cambio automatico / + transmission automatique / + cambio automatico

<sup>6)</sup> flare type F / bordatura tipo F / colet F / reborde F





















<sup>7)</sup> + CI/ flare type F / + ghisa/ bordatura tipo F / + fonte grise/ colet F / + FG/ reborde F

<sup>8)</sup> + CI/ flare type F/ - tappet / + ghisa/bordat.tipo F/-punter. / + fonte gr./colet F/-boul.pres. / + FG/ reborde F/-perno presión

<sup>9)</sup> + fist type calipers / + pinza freno flottante / + étriers à griffe / + pinza de puno

								
<b>Classic PKW OPEL OMEGA A / Vauxhall Carlton (87-93)</b>								
	1.8		L1019854	08.86		BA2134		20939 15,4 /WE DEL
	2.3 D		L1019854	08.86				
	2.3 TD		L1019854	08.86				
	2.0		K1000098	08.86		BA2137 BA2134	2	21190 17,5 +/WE ATE 20939 15,4 /WE DEL
	1.8	L1019855			08.93	BA2137		21190 17,5 +/WE ATE
2.0	K1000099			08.93	BAV1029	2	Warnkontakt L=660mm	
2.3 D	L1019855			08.93				
2.3 TD	L1019855			08.93				
2.4	K1000099			08.93				
2.6				09.90	08.93	BA2175		21368 18,3 /WE/S LUC
3.0	M1000001			08.93	08.93			
3.0 24V				08.89	08.93			
	1.8		L1019854	08.86	+ ABS	BAR24111		258 23,9 21,0 V
	1.8	L1019855			08.93			
	2.0			08.86	08.93			
	2.3 D		L1019854	08.86	+ ABS			
	2.3 D	L1019855			08.93			
	2.3 TD		L1019854	08.86	+ ABS			
	2.3 TD	L1019855			08.93			
	2.4			08.88	08.93			
	2.6			09.90	08.93	BAR28104		296 28,0 25,0 V L
3.0	M1000001			08.93				
3.0 24V			08.89	08.93				
	1.8 Caravan			08.86	08.93	BA2095		21050 15,7 ATE
	1.8 Limousine	K1000099			08.93			
	2.0 Caravan			08.86	08.93			
	2.0 Limousine	K1000099			08.93			
	2.3 D Caravan			08.86	08.93			
	2.3 D Limousine	K1000099			08.93			
	2.3 TD Caravan			08.86	08.93			
	2.3 TD Limousine	K1000099			08.93			
	2.4			08.88	08.93			
	2.6			09.90	08.93			
3.0			08.86	08.93				
3.0 24V			08.89	08.93				
	1.8			08.86	08.93	BAR10191		270 9,9 8,0
	2.0			08.86	08.93			
	2.3 D			08.86	08.93			
	2.3 TD			08.86	08.93			
	2.4			08.88	08.93			
	2.6			09.90	08.93			
	3.0			08.86	08.93			
	3.0 24V			08.89	08.93			
<b>Classic PKW OPEL REKORD E / Vauxhall Carlton (77-86)</b>								
	alle Typen			01.79	12.86 + Faustsättel <sup>1)</sup>	BA2134		20939 15,4 /WE DEL
<b>Classic PKW OPEL SENATOR B / Vauxhall Royal (88-93)</b>								
	2.5	M1000001			09.93	BA2175		21368 18,3 /WE/S LUC
	2.6	M1000001			09.93			
	3.0	M1000001			09.93			
	3.0 24V			08.89	09.93			
	2.5	M1000001			09.93	BAR28104		296 28,0 25,0 V L
	2.6	M1000001			09.93			
	3.0	M1000001			09.93			
	3.0 24V			08.89	09.93			
	2.5			09.90	09.93	BA2095		21050 15,7 ATE
	2.6			08.90	09.93			
	3.0			09.87	09.93			
	3.0 24V			08.89	09.93			
	2.5			09.90	09.93	BAR10191		270 9,9 8,0
	2.6			08.90	09.93			
	3.0			09.87	09.93			
	3.0 24V			08.89	09.93			
<b>Classic PKW PEUGEOT J5 (81-94)</b>								
	1.8	51		11.81	06.94	BA2024		20741 19,2 +/WK/S LUC
	1.9 D			10.87	06.94			
	2.0	55		11.81	06.94			
	2.0	58		11.81	06.94			
	2.5 D	54		11.81	06.94 - 1,8 t			
	2.5 TD	70		10.87	06.94 - 1,8 t			
	1.8	51 0154462			06.94	BAR16105		256 16,1 13,5
	1.9 D			10.87	06.94			
	2.0	55 0154462			06.94			
	2.0	58 0154462			06.94			
	2.5 D	54 0154462			06.94 - 1,8 t			
2.5 TD	70		10.87	06.94 - 1,8 t				
	1.9 D			10.87	06.94 - 0,8 t	BAW2501		Rz 25,40 LUC
	2.0	55 0077160			06.94			
	2.0	58 0077160			06.94			
	2.5 D	54 0077160			06.94 - 1,8 t			
↓	↓							

<sup>1)</sup> + fist type calipers / + pinza freno flottante / + étriers à griffe / + pinza de puno

									
<b>Classic PKW PEUGEOT J5 (81-94)</b>									
	2.5 TD	70	10.87	06.94	-1,8 t	BAW2501		Rz 25,40	LUC
<b>Classic PKW PEUGEOT 205 (83-90)</b>									
	1.0	33	01.83	08.90		BA2055		20905 18,0 +/WK	BDX
	1.1		01.83	08.90		BA2036		20989 17,5 +/WK	LUC
	1.4		01.83	08.90					
	1.6		08.86	08.90					
	1.6	58	10.87	08.90	+ Automatikgetriebe <sup>1)</sup>				
	1.6	65	05.90	08.90	+ Automatikgetriebe <sup>1)</sup>				
	1.6 GTI/CTI		01.84	08.90					
	1.7 D	44	07.83	08.90					
	1.9 D		09.88	08.90					
	1.1 i		09.89	08.90		BA2055		20905 18,0 +/WK	BDX
1.3 Rallye		09.87	08.90		BA2036		20989 17,5 +/WK	LUC	
1.4 i		09.88	08.90						
1.9 GTI/CTI	75	04.89	08.90						
	1.0	33	01.83	08.90		BAR10187		247 10,0 8,0	
	1.1		01.83	08.90					
	1.1 i		07.89	08.90					
	1.4		01.83	08.90					
	1.4 i		07.88	08.90					
	1.6		08.86	02.87					
	1.7 D	44	07.83	08.90					
	1.9 D		09.88	08.90					
	1.9 GTI	88	09.88	08.90		BAR20132		247 20,4 18,5 V	
	1.9 GTI	94	10.86	08.88					
	1.9 GTI	88	09.88	08.90		BA2076		20973 11,0 +	BDX
	1.9 GTI	94	10.86	08.88					
	1.0	33	01.83	08.90		BAE5020		180 x 32 AUT	BDX
	1.1		01.83	08.89					
	1.4		01.83	08.90					
	1.6		08.86	02.87					
	1.7 D	44	07.83	08.90					
	1.9 D		09.88	08.90					
<b>Classic PKW PEUGEOT 305 (77-90)</b>									
	1.3		10.82	08.86		BA2055		20905 18,0 +/WK	BDX
	1.5		10.82	07.90					
	1.6		10.82	12.88					
	1.6 GT		07.84	08.87					
	1.8	59	11.82	12.88					
	1.8 D	44	11.82	12.88					
	1.9	75	10.82	10.87					
	1.9 D		10.82	12.88					
	1.9 i	72	10.86	12.88		BA2055		20905 18,0 +/WK	BDX
		1.6 GT		07.84	08.87		BAR20133		266 20,5 18,5 V
1.9		75	10.82	10.87					
1.9 i		72	10.86	12.88					
<b>Classic PKW PEUGEOT 405 (87-92)</b>									
	1.4 i	47	01.87	08.92		BA2055		20905 18,0 +/WK	BDX
	1.6		09.87	08.92					
	1.8 D Kombi		03.88	08.92 + (F)					
	1.8 TD	66	09.88	08.90					
	1.9	70	09.87						
	1.9 D		S 70536851 S 70536851	05.88					
	1.6		09.87	08.92		BA2043		21209 18,5 +/WK/S	LUC
	1.8 TD	66	09.90	08.92					
	1.9	70 S 70536852		08.92					
	1.9	80	09.88	08.92					
	1.9	93	07.87	08.92					
	1.9 D	S 70536852		08.92					
	1.9 i	77	09.87	08.88					
	1.9 i	88	09.88	08.92					
	1.9 Mi 16	108	05.88	08.92					
	1.9 Mi 16	116	09.87	12.88					
	1.8 TD	66	09.90	08.92		BAR20133		266 20,5 18,5 V	
	1.9	70 S 70536852		08.92					
	1.9	80	09.88	08.92					
	1.9	93	07.87	08.92					
	1.9 D	S 70536852		08.92					
	1.9 i	77	09.87	08.88					
1.9 i	88	09.88	08.92						
1.9 Mi 16	108	05.88	08.92						
1.9 Mi 16	116	09.87	12.88						
	1.9 Mi 16 X4	108	05.88	08.92		BA2032		20961 15,2 /S	LUC
	1.9 X4	80	09.88	08.92					
	1.9 Mi 16 X4	108	05.88	08.92		BAR10187		247 10,0 8,0	
	1.9 X4	80	09.88	08.92					

<sup>1)</sup> + autom.transmission / + scatola cambio automatico / + transmission automatique / + cambio automático



<b>Classic PKW RENAULT ALPINE A310 (77-84)</b>								
	2.7 (2700VA)		0047708	01.77		BA2082		20336 14,0 +/WK BDX
<b>Classic PKW RENAULT ESPACE I (J/S 11_) (84-90)</b>								
	2.0 (J/S112)	74		01.88	12.90	BA2055		20905 18,0 +/WK BDX
	2.0 (J/S112)	80		07.84	12.90	BA2023		21463 18,0 /WK/S LUC
	2.0 i (J116)	87		01.89	12.90			
	2.0 i Quadra (J116)	87		03.88	12.92			
	2.1 TD (J/S115)	65		10.84	12.90			
	2.2 (J117)	79		07.86	12.90			
	2.2 Quadra	81		06.87	12.87			
	2.2 Quadra (J117)	79		01.88	12.90			
	2.0 (J/S112)	74		01.88	12.90	BAR20126		259 20,2 17,7 V
	2.0 (J/S112)	80	T022234		12.90			
	2.0 (J/S112)	80	T000349		12.90			
	2.0 i (J116)	87		01.89	12.90			
	2.0 i Quadra (J116)	87		03.88	12.92			
	2.1 TD (J/S115)	65	T012278		12.90			
	2.1 TD (J/S115)	65	T000494		12.90			
	2.2 (J117)	79		07.86	12.90			
	2.2 Quadra	81		06.87	12.87			
	2.2 Quadra (J117)	79		01.88	12.90			
	2.0 i (J116)	87		01.89	12.90 + ABS	BA2082		20336 14,0 +/WK BDX
	2.0 i Quadra (J116)	87		03.88	12.92			
	2.1 TD (J/S115)	65		10.84	12.90 + Niveauregulierung 1)			
	2.2 (J117)	79		07.86	12.90 + ABS			
	2.2 Quadra	81		06.87	12.87			
	2.2 Quadra (J117)	79		01.88	12.90			
<b>Classic PKW RENAULT FUEGO (80-92)</b>								
	1.4 (R1360)			01.80	12.85	BA2055		20905 18,0 +/WK BDX
	1.6 (R1361)			01.83	12.85	BA2023		21463 18,0 /WK/S LUC
	1.6 (R1362)			01.80	12.85			
	2.0 (R1363)			01.81	12.85	BA2055		20905 18,0 +/WK BDX
	1.6 T (R1365)			01.84	12.85	BA2023		21463 18,0 /WK/S LUC
	2.1 (R1366)			01.83	12.84			
	1.6 T (R1365)			01.84	12.85	BAR20126		259 20,2 17,7 V
	2.1 (R1366)	0003901			12.84			
	1.6 T (R1365)			01.84	12.85	BA2082		20336 14,0 +/WK BDX
<b>Classic PKW RENAULT R5 SUPER (85-96)</b>								
	1.0 (B/C/S 400)			01.85	08.90	BA2077		21097 15,0 +/WK BDX
	1.1 (B/C/- 40H)			06.87	08.90			
	1.1 (B/C/S 401)			01.85	03.95			
	1.2 (B/C/S 40F)			01.86	08.90	BA2055		20905 18,0 +/WK BDX
	1.4 (-/C/- 405)			01.85	08.90	BA2023		21463 18,0 /WK/S LUC
	1.4 (B/C/- 402)			01.85	08.90			
	1.4 (B/C/- 403)			01.85	08.90			
	1.4 (B/C/- 407)			01.85	12.96			
	1.4 (B/C/- 40J)			06.87	08.90			
	1.4 (B/C/- 40M)			06.87	08.90			
	1.6 (B/C/S 404)			01.86	12.96			
	1.7 (-/C/- 409)			01.87	08.91			
	1.7 (B/C/- 408)			01.87	03.95			
	1.7 (B/C/- 40G)			06.87	03.95			
	1.7 (B/C/- 40K)			06.87	03.95			
	1.0 (B/C/S 400)			01.85	08.90	BAR08104		238 8,2 7,0
	1.1 (B/C/- 40H)			06.87	08.90			
	1.1 (B/C/S 401)			01.85	03.95			
	1.2 (B/C/S 40F)			01.85	08.90	BAR12116		238 12,0 10,5
	1.4 (B/C/- 402)			01.85	08.90			
	1.4 (B/C/- 403)			01.85	08.90			
	1.4 (B/C/- 407)			01.85	12.96			
	1.4 (B/C/- 40J)			06.87	08.90			
	1.4 (B/C/- 40M)			06.87	08.90			
	1.6 (B/C/S 404)			01.85	12.96			
	1.7 (B/C/- 408)			01.87	03.95			
	1.4 (-/C/- 405)			01.85	08.90	BAR20125		238 20,0 17,7 V
	1.7 (-/C/- 409)			01.87	08.91			
	1.7 (B/C/- 40G)			06.87	03.95			
	1.7 (B/C/- 40K)			06.87	03.95			
	1.4 (-/C/- 405)			01.85	08.90	BA2076		20973 11,0 + BDX
	1.7 (-/C/- 409)			01.87	08.91			
	1.0 (B/C/- 400)			06.87	08.90	BAW2005		RzR 20,64 BDX
	1.1 (B/C/- 401)			06.87	03.95	BAW2006		RzR 20,64 BDX
	1.1 (B/C/- 40H)			06.87	08.90			
	1.2 (-/C/S 40F)			06.87	08.90			
	1.2 (B/-/ 40F)			06.87	08.90 - E			
	1.4 (-/C/- 403)			06.87	08.90			
	1.4 (B/-/ 403)			06.87	08.90 - E			

1) + suspension level control / + correttore assetto / + correcteur d'assiette / + regulaci3n altura suspensi3n



**Classic PKW RENAULT R5 SUPER (85-96)**

























	1.4 (B/C/- 402)		06.87	08.90	BAW2005 BAW2006		RzR 20,64 RzR 20,64	BDX BDX
	1.4 (B/C/- 407)		06.87	12.96				
	1.4 (B/C/- 40J)		06.87	08.90				
	1.4 (B/C/- 40M)		06.87	08.90				
	1.6 (-/C/S 404)		06.87	12.96				
	1.6 (B/-/- 404)		06.87	12.96				
	1.7 (B/C/- 408)		06.87	03.95				
1.7 (B/C/- 40K)		06.87	03.95					
	1.0		01.85	08.90	BAE5008		180 x 42	BDX
	1.1		01.85	03.95				
	1.2		01.86	08.90				
	1.4	85	01.85	12.96				
	1.6		01.85	12.96				
	1.7		06.87	03.95				













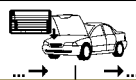

**Classic PKW RENAULT R9 (82-89)**

	1.1 (L421)	35	01.82	06.87	BA2055 BA2023		20905 18,0 +/WK 21463 18,0 /WK/S	BDX LUC
	1.2 (L42S)	40	01.86	11.89				
	1.4 (L422)	44	01.82	12.86				
	1.4 (L423)		01.82	11.89				
	1.4 (L42C)	44	10.86	11.89				
	1.4 (L42R)	49	10.86	11.89				
	1.4 i (L42A)		06.87	11.89				
	1.6 (L424)	40	01.83	11.89				
	1.7 (L426)	59	01.85	06.87				
	1.7 (L42L)	55	10.86	11.89				
	1.7 i (L42F)	54	01.85	11.89				
	1.4 T (L425)		01.85	11.89				
1.7 (L42D)		06.87	11.89					
1.7 (L42N)	65	10.86	11.89					
1.7 i (L42E)	69	10.86	11.89					
	1.1 (L421)	35 0084201		06.87	BAR12116		238 12,0 10,5	
	1.2 (L42S)	40	01.86	11.89				
	1.4 (L422)	44 0170421		12.86				
	1.4 (L423)		01.82	11.89				
	1.4 (L42C)	44	10.86	11.89				
	1.4 (L42R)	49	10.86	11.89				
	1.4 i (L42A)		06.87	11.89				
	1.6 (L424)	40	01.83	11.89				
	1.7 (L426)	59	01.85	06.87				
	1.7 (L42L)	55	10.86	11.89				
	1.7 i (L42F)	54	01.85	11.89				
	1.4 T (L425)		01.85	11.89				
1.7 (L42D)		06.87	11.89					
1.7 (L42N)	65	10.86	11.89					
1.7 i (L42E)	69	10.86	11.89					
	1.4 T (L425)		10.86	11.89	BA2076		20973 11,0 +	BDX
	1.1 (L421)	35	01.82	06.87	BAE5008		180 x 42	BDX
	1.2 (L42S)	40	01.86	11.89				
	1.4 (L422)	44	01.82	12.86				
	1.4 (L423)		01.82	11.89				
	1.4 (L42C)	44	10.86	11.89				
	1.4 (L42R)	49	10.86	11.89				
	1.4 i (L42A)		06.87	11.89				
	1.6 (L424)	40	01.83	11.89				
	1.7 (L426)	59	01.85	06.87				
	1.7 (L42D)		06.87	11.89				
	1.7 (L42L)	55	10.86	11.89				
	1.7 i (L42E)	69	10.86	11.89				
1.7 i (L42F)	54	01.85	11.89					

**Classic PKW RENAULT R11 (83-89)**

	1.1 (-/S 371)	35	01.84	10.86	BA2055 BA2023		20905 18,0 +/WK 21463 18,0 /WK/S	BDX LUC
	1.1 (B/C/- 371)	35	01.83	06.87				
	1.2 (B/C/S 37S)	40	01.86	11.89				
	1.4 (-/S 373)		01.85	10.86				
	1.4 (B/C/- 372)	44	01.83	12.86				
	1.4 (B/C/- 373)		01.83	11.89				
	1.4 (B/C/- 37C)	44	10.86	11.89				
	1.4 (B/C/- 37R)	49	06.87	11.89				
	1.4 i (B/C/- 37A)		06.87	11.89				
	1.6 D (B/C/S 374)	40	01.84	11.89				
	1.7 (B/C/- 376)	59	01.84	06.87				
	1.7 (B/C/- 37L)	54	10.86	11.89				
	1.7 i (B/C/- 37F)	55	01.85	11.89				
	1.4 T (B/C/- 375)		01.84	11.89				
1.7 (B/C/- 37D)	64	06.87	11.89					
1.7 (B/C/- 37N)	65	10.86	11.89					
1.7 i (B/C/- 37E)	69	10.86	11.89					
	1.1 (-/S 371)	35	01.84	10.86	BAR12116		238 12,0 10,5	
	1.1 (B/C/- 371)	35	01.83	06.87				
	1.2 (B/C/S 37S)	40	01.86	11.89				
	1.4 (-/S 373)		01.85	10.86				
	1.4 (B/C/- 372)	44	01.83	12.86				

								
<b>Classic PKW RENAULT R11 (83-89)</b>								
	1.4 (B/C/- 373)		01.83	11.89	BAR12116			238 12,0 10,5
	1.4 (B/C/- 37C)	44	10.86	11.89				
	1.4 (B/C/- 37R)	49	06.87	11.89				
	1.4 i (B/C/- 37A)		06.87	11.89				
	1.6 D (B/C/S 374)	40	01.84	11.89				
	1.7 (B/C/- 376)	59	01.84	06.87				
	1.7 (B/C/- 37L)	54	10.86	11.89				
	1.7 i (B/C/- 37F)	55	01.85	11.89				
	1.4 T (B/C/- 375)		01.84	11.89	BAR20125			238 20,0 17,7 V
	1.7 (B/C/- 37D)	64	06.87	11.89				
	1.7 (B/C/- 37N)	65	10.86	11.89				
	1.7 i (B/C/- 37E)	69	10.86	11.89				
	1.4 T (B/C/- 375)		10.86	11.89	BA2076			20973 11,0 + BDX
	1.1 (B/C/S 371)	35	01.83	06.87	BAE5008			180 x 42 BDX
	1.2 (B/C/S 37S)	40	01.86	11.89				
	1.4 (B/C/- 37C)	44	10.86	11.89				
	1.4 (B/C/- 37R)	49	06.87	11.89				
	1.4 (B/C/S 373)		10.86	11.89				
	1.4 i (B/C/- 37A)		06.87	11.89				
	1.6 D (B/C/S 374)	40	10.86	11.89				
	1.7 (B/C/- 376)	59	09.86	06.87				
	1.7 (B/C/- 37D)	64	06.87	11.89				
	1.7 (B/C/- 37L)	54	10.86	11.89				
	1.7 (B/C/- 37N)	65	10.86	11.89				
	1.7 i (B/C/- 37E)	69	10.86	11.89				
	1.7 i (B/C/- 37F)	55	01.85	11.89				
	<b>Classic PKW RENAULT R17 (72-80)</b>							
	1.6 (R1313)		01.72	12.76	BA2082			20336 14,0 +/WK BDX
	1.6 (R1317)		01.72	12.80				
	1.6 (R1327)		01.72	12.80				
	1.6 TS (R1323)		01.72	12.77				
<b>Classic PKW RENAULT R18 Kasten (79-86)</b>								
	1.4 (R2350)	47	01.83	07.86	BA2055			20905 18,0 +/WK BDX
	2.1 D (R2354)	49	01.83	07.86	BA2023			21463 18,0 /WK/S LUC
	2.1 D (R2354)	49	01.83	07.86	BA2055			20905 18,0 +/WK BDX
<b>Classic PKW RENAULT R18 Limousine (78-86)</b>								
	1.4 (R1340)	47	01.83	07.86	BA2055			20905 18,0 +/WK BDX
	1.6 (R1341)	54	01.83	07.86				
	2.0 (R1343)	77	01.83	07.86				
	2.1 D (R1344)	49	01.83	07.86				
	2.1 D (R1346)	53	11.81	07.86				
	1.6 TS (R1342)	71	01.83	07.86				
	1.6 Turbo (R1345)	92	01.83	07.86	BA2023			21463 18,0 /WK/S LUC
	1.4 (R1340)	47 0534401		07.86	BAR20126			259 20,2 17,7 V
	1.6 (R1341)	54 0504401		07.86				
	1.6 (R1341)	58 0504401		09.82				
	1.6 Turbo (R1345)	80	10.80	09.82	BA2082			20336 14,0 +/WK BDX
	1.6 Turbo (R1345)	92	10.82	07.86				
<b>Classic PKW RENAULT R18 Variable (79-86)</b>								
	1.4 (R1350)	47	01.83	07.86	BA2055			20905 18,0 +/WK BDX
	1.6 (R1351)	54	01.83	07.86				
	1.6 4x4 (R1351)	54	01.83	07.86				
	2.0 (R1353)	77	01.83	07.86				
	2.0 4x4 (R1353)	76	05.83	12.86				
	1.6 TS (R1352)	71	01.83	07.86				
	1.6 Turbo (R1355)	92	01.83	07.86				
	2.1 D (R1354)	49	01.83	07.86				
	2.1 D (R1356)	53	01.83	07.86	BA2023			21463 18,0 /WK/S LUC
	1.6 Turbo (R1355)	80	09.82	07.86	BA2055			20905 18,0 +/WK BDX
	1.6 Turbo (R1355)	92	10.82	07.86				
	1.6 Turbo (R1355)	80	09.82	07.86	BAR20126			259 20,2 17,7 V
	1.6 Turbo (R1355)	92	10.82	07.86				
	1.6 Turbo (R1355)	80	09.82	07.86	BA2082			20336 14,0 +/WK BDX
	1.6 Turbo (R1355)	92	10.82	07.86				
<b>Classic PKW RENAULT R20 (76-84)</b>								
	1.6 (R1271)		06.80	12.81	BA2055			20905 18,0 +/WK BDX
	2.0 (R1272)		01.81	12.84				
	2.0 (R1277)		01.81	12.84				
	2.1 (R1276)		01.80	12.84				
	2.0 (R1272)		01.78	12.80	BAR24103			252 24,0 22,0 V
	2.0 (R1272)		01.81	12.84				
	2.0 (R1277)		01.81	12.84				
	2.2 (R1279)		01.81	12.84				

									
<b>Classic PKW RENAULT R21 Limousine (B48/L48_) (86-93)</b>									
	1.4 (B/L 48D)	51	06.88	12.92	BA2055			20905 18,0 +/WK	BDX
	1.7 (B/L 481)	55	01.86	12.92	BA2023			21463 18,0 /WK/S	LUC
	1.7 (L 48M)	54	10.87	05.90					
	1.7 i (B 48F)	54	08.86	12.93					
	1.6 (B/L 48U)		06.88	12.93	BA2023			21463 18,0 /WK/S	LUC
	1.7 (B/L 482)	65	01.86	12.92					
	1.7 (B/L 484)		06.90	12.93					
	1.7 (B/L 48J)		01.87	05.91					
	1.7 (L 48N)	64	10.87	05.90					
	1.7 i (B/L 48E)	66	08.86	12.93					
	1.9 D (B/L 48H)	47	05.89	12.92					
	1.9 D (B/L 48I)	47	04.92	12.93					
	2.0 (L 489)		01.87	03.93	BA2060			21016 17,0 +/WK	BDX
	2.0 i (B/L 483)		01.86	12.92					
	2.0 i (B/L 48C)	88	06.90	12.93					
	2.0 i (B/L 48R)	99	05.89	12.93					
	2.0 i (B/L 48Y)	99	05.89	03.92					
	2.0 i (L 48Q)		05.89	03.92					
	2.0 T (L 485)		06.87	03.92					
	2.0 T (L 48L)		05.89	12.93					
	2.1 D (B/L 480)	51	04.92	12.93					
	2.1 D (B/L 480)	53	04.92	12.93					
	2.1 D (B/L 48V)	53	05.89	12.93					
	2.1 TD (B/L 486)	65	01.86	12.92					
2.1 TD (B/L 487)	65	06.91	12.93						
2.1 TD (B/L 488)	65	01.86	10.92						
2.1 TD (B/L 48A)	65	04.92	12.93						
2.1 TD (B/L 48W)	65	05.89	05.91						
2.2 i (B/L 48K)	79	08.86	12.93						
2.2 i (L 48S)	79	06.88	12.93						
	1.4 (B/L 48D)	51	06.88	12.92	BAR12116			238 12,0 10,5	
	1.7 (B/L 481)	55	01.86	12.92					
	1.6 (B/L 48U)		06.88	12.93	BAR20125			238 20,0 17,7 V	
	1.7 (B/L 482)	65	01.86	12.92					
	1.7 (B/L 484)		06.90	12.93					
	1.7 (B/L 48J)		01.87	05.91					
	1.7 (L 48M)	54	10.87	05.90					
	1.7 (L 48N)	64	10.87	05.90					
	1.7 i (B 48F)	54	08.86	12.93					
	1.7 i (B/L 48E)	66	08.86	12.93					
	1.9 D (B/L 48H)	47	05.89	12.92					
	1.9 D (B/L 48I)	47	04.92	12.93					
	1.4 (B/L 48D)	51	06.88	12.92	BAH0024	2		L=240	
	1.6 (L 48U)		06.88	12.93					
	1.7 (B 482)	65	09.89	12.92					
	1.7 (B/L 481)	55	01.86	12.92					
	1.7 (B/L 484)		06.90	12.93					
	1.7 (B/L 48J)		01.87	05.91					
	1.7 (L 482)	65	01.86	12.92					
	1.7 (L 48M)	54	10.87	05.92					
	1.7 (L 48N)	64	10.87	05.92					
	1.7 i (B 48F)	54	08.86	12.93					
	1.7 i (L 48E)	66	08.86	12.93					
	1.9 D (B/L 48H)	47	05.89	12.92					
	1.9 D (B/L 48I)	47	04.92	12.93					
		2.0 i (B/L 483)		03.87	12.92 + ABS	BA2082			20336 14,0 +/WK
2.0 i (B/L 48C)		88	06.90	12.93 + ABS	BA2107			20410 15,0 +	BRE
2.0 i (B/L 48R)		99	05.89	12.93					
2.0 i (B/L 48Y)		99	05.89	03.92					
2.0 i (L 48Q)			05.89	03.92					
2.0 T (L 485)			06.87	03.92					
2.0 T (L 48L)			05.89	12.93					
2.1 D (B 480)		53	04.92	12.92 + ABS					
2.1 D (B/L 480)		51	04.92	12.93 + ABS					
2.1 TD (B 487)		65	06.91	12.93 + ABS					
2.1 TD (B/L 488)		65	03.87	10.92 + ABS					
2.1 TD (B/L 48A)		65	04.92	12.93 + ABS					
2.1 TD (L 48P)		65	07.91	03.92 + ABS					
2.2 i (B/L 48K)		79	03.87	12.93 + ABS					
	1.4 (B/L 48D)	51	06.88	12.92	BAE5008			180 x 42	BDX
	1.6 (B 48U)		06.90	03.92					
	1.6 (L 48U)		06.88	12.93 + MA					
	1.7 (B/L 481)	55	01.86	12.92					
	1.7 (B/L 482)	65	01.86	12.92					
	1.7 (B/L 484)		06.90	12.93					
	1.7 (B/L 48J)		01.87	05.91					
	1.7 (L 48M)	54	10.87	05.90					
	1.7 (L 48N)	64	10.87	05.90					
	1.7 i (B 48F)	54	08.86	12.93					
	1.7 i (B/L 48E)	66	08.86	12.93					
	1.9 D (B/L 48H)	47	05.89	12.92					
	1.9 D (B/L 48I)	47	04.92	12.93					
	2.1 D (B/L 480)	51	04.92	12.93 - ABS					
	2.1 D (B/L 480)	53	04.92	12.93					
	2.1 D (B/L 48V)	53	05.89	12.93					
2.1 TD (B/L 486)	65	01.86	12.92						

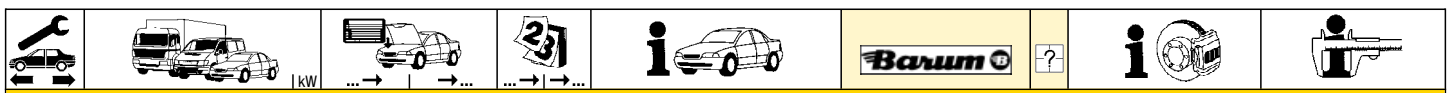

**Classic PKW RENAULT R25 (84-92)**

	2.0 (B297) 2.0 i (B292) 2.0 i (B294) 2.0 i (B29H) 2.1 D (B296) 2.1 TD (B290) 2.1 TD (B29W) 2.2 i (B29B) 2.2 i (B29B) 2.2 i (B29B) 2.2 i (B29E) 2.2 i (B29E) 2.2 i (B29E)		01.84 06.88 02.90 01.87 01.84 01.84 06.89 01.86 06.87 06.88 01.84 06.87 06.88	12.92 12.92 12.92 12.92 12.92 12.92 02.90 05.88 - ABS 05.88 + ABS 12.92 05.88 - ABS 05.88 + ABS 06.89	BA2023		21463 18,0 /WK/S	LUC
	2.2 i (B29B) 2.2 i (B29E) 2.5 T (B295) 2.5 T (B29G) 2.7 V6 (B298) 2.8 V6 (B293) 2.8 V6 (B29A) 2.8 V6 (B29F)		01.86 01.84 01.85 06.89 01.84 06.87 01.87 06.87	05.87 + ABS 05.87 + ABS 06.89 12.92 05.89 06.89 05.88 12.92	BA2050		21388 18,3 +/-WK/S	LUC
	2.0 (B297) 2.0 i (B292) 2.0 i (B294) 2.0 i (B29H) 2.1 D (B296) 2.1 TD (B290) 2.1 TD (B29W) 2.2 i (B29B) 2.2 i (B29B) 2.2 i (B29B) 2.2 i (B29E) 2.2 i (B29E) 2.2 i (B29E)		01.84 06.88 02.90 01.87 01.84 01.84 06.89 01.86 06.87 06.88 01.84 06.87 06.88	12.92 12.92 12.92 12.92 12.92 12.92 02.90 05.88 - ABS 05.88 + ABS 12.92 05.88 - ABS 05.88 + ABS 06.89	BAR20126		259 20,2 17,7 V	
	2.0 (B297) 2.0 i (B292) 2.0 i (B294) 2.0 i (B29H) 2.1 D (B296) 2.1 TD (B290) 2.1 TD (B29W) 2.2 i (B29B) 2.2 i (B29E) 2.5 T (B295) 2.5 T (B29G) 2.7 V6 (B298) 2.8 V6 (B293) 2.8 V6 (B29A) 2.8 V6 (B29F)		01.84 06.88 02.90 01.87 01.84 01.84 06.89 01.86 01.84 01.85 06.89 01.84 06.87 01.87 06.87	12.92 + ABS 12.92 12.92 12.92 + ABS 12.92 + ABS 12.92 + ABS 02.90 + ABS 12.92 + ABS 06.89 + ABS 06.89 12.92 05.89 06.89 05.88 12.92	BA2082		20336 14,0 +/-WK	BDX

**Classic PKW RENAULT R30 (75-84)**



























	2.1 TD (R1270)	63	01.82	12.84	BA2023		21463 18,0 /WK/S	LUC
	2.6 V6 (R1275)	94	01.75	12.84	BAR24103		252 24,0 22,0 V	
	2.6 V6 (R1275)	94	01.75	12.84	BA2082		20336 14,0 +/-WK	BDX

**Classic PKW RENAULT TRAFIC I Bus (T5/T6/T7) (80-89)**

























	1.4 1.6 1.6 4x4 1.7 2.0 2.1 D 2.1 D 4X4	35 48 48 50 59 43 43	01.85 01.85 01.85 06.86 01.85 01.85 05.85	04.89 06.86 08.86 04.89 04.89 04.89 02.89	BA2086		20926 18,5 /WK	BDX
	1.4 1.6 1.6 4x4 1.7 2.0 2.1 D 2.1 D 4X4	35 48 48 50 59 43 43	03.80 01.84 03.80 06.86 03.80 03.80 05.85	04.89 06.86 08.86 04.89 04.89 04.89 02.89	BAR24103		252 24,0 22,0 V	

**Classic PKW RENAULT TRAFIC I Kasten (T1/T2/T3/T4) (80-89)**

	1.4 1.6 1.6 4x4 1.7 2.0 2.0 2.0 4x4	35 48 48 50 58 59 60 59	03.80 01.83 08.85 06.86 07.80 03.80 05.85 03.80	04.89 06.86 06.86 04.89 04.85 04.89 02.89 04.89	BAR24103		252 24,0 22,0 V	
↓	↓							













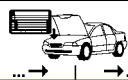









								
<b>Classic PKW RENAULT TRAFIC I Kasten (T1/T2/T3/T4) (80-89)</b>								
	2.1 D 2.1 D 4x4	43 43	09.80 11.86	04.89 04.89	BAR24103			252 24,0 22,0 V
<b>Classic PKW RENAULT TRAFIC I PROPULSION (PXX) (81-89)</b>								
	1.7 (P3--) 2.0 (P3--) 2.1 D (P3--)	50 0005151 59 0005151 43 0005151		04.89 04.89 04.89	BA2086			20926 18,5 /WK BDX
	1.7 (P3--) 2.0 (P3--) 2.1 D (P3--)	50 59 43	01.81 01.81 01.81	04.89 04.89 04.89	BAR24103			252 24,0 22,0 V
<b>Classic PKW SEAT FURA (82-86)</b>								
	0.9		02.82	12.86	BA2062			20073 17,3 BDX
<b>Classic PKW SEAT RONDA (83-86)</b>								
	1.2 1.5 1.6 1.7 D		06.83 09.85 06.83 06.83	07.86 07.86 08.85 07.86	BA2065			20775 18,0 /WK BDX
<b>Classic PKW SKODA S 100 (70-77)</b>								
	S 100		08.76	12.77	BA2126			20576 15,5
<b>Classic PKW SKODA S 105 (77-90)</b>								
	S 105		01.77	12.90	BA2126			20576 15,5
<b>Classic PKW SKODA S 110 (70-82)</b>								
	S 110		01.76	03.82	BA2126			20576 15,5
<b>Classic PKW SKODA S 120 (77-90)</b>								
	S 120		01.77	12.90	BA2126			20576 15,5
<b>Classic PKW TALBOT MATRA BAGHEERA (74-80)</b>								
	1.3 1.4		01.74 12.75	03.78 09.80	BA2082			20336 14,0 +/WK BDX
<b>Classic PKW TALBOT MATRA MURENA (81-85)</b>								
	1.6 2.1		08.81 04.83	01.85 01.85	BA2082			20336 14,0 +/WK BDX
<b>Classic PKW TOYOTA CAMRY (82-86)</b>								
	1.8 (SV10) 1.8 TD (CV10) 2.0 (SV11) 2.0 TD (CV11)		10.82 10.82 10.82 08.85	10.86 07.85 10.86 10.86	BA2121			20870 15,0 AKE
	1.8 (SV10) 1.8 TD (CV10) 2.0 (SV11) 2.0 TD (CV11)		10.82 10.82 10.82 08.85	10.86 07.85 10.86 10.86	BAE5035			200 x 37
<b>Classic PKW TOYOTA CAMRY (86-91)</b>								
	1.8 (SV20) 2.0 i (SV21) 2.0 TD (CV20)		10.86 10.86 10.86	07.88 + Limousine 1) 05.91 + Limousine 1) 05.91 + Limousine 1)	BAE5035			200 x 37
<b>Classic PKW TOYOTA CARINA II (83-87)</b>								
	1.6 (AT151) 1.8 (ST150) 2.0 D (CT150)		10.83 10.83 10.83	11.87 11.87 11.87	BAE5035			200 x 37
<b>Classic PKW TOYOTA CELICA (85-89)</b>								
	1.6 (AT160) 1.6 i (AT160) 2.0 i (ST162)		08.85 08.85 08.85	09.89 09.89 09.89 - ABS	BA2121			20870 15,0 AKE
	1.6 (AT160) 1.6 i (AT160)		08.85 08.85	09.89 09.89	BAE5035			200 x 37

1) + Saloon / + Berlina / + Berline / + Berlina

								
<b>Classic PKW TOYOTA COROLLA (83-87)</b>								
	1.3 (AE80) 1.3 (EE80) 1.6 (AE82) 1.8 D (CE80)		05.83 05.83 05.83 05.83	04.87 04.87 04.87 04.87	BA2121			20870 15,0 AKE
<b>Classic PKW TOYOTA CORONA (82-87)</b>								
	1.6 (AT151) 1.8 (ST150) 2.0 (ST151) 2.0 D (CT150)		10.83 10.83 10.83 10.83	11.87 11.87 11.87 11.87	BA2121			20870 15,0 AKE
	1.6 (AT151) 1.8 (ST150) 2.0 (ST151) 2.0 D (CT150)		10.83 10.83 10.83 10.83	11.87 11.87 11.87 11.87	BAE5035			200 x 37
<b>Classic PKW TOYOTA MR2 (84-89)</b>								
	1.6 i 16V (AW11)		11.84	12.89	BA2121			20870 15,0 AKE
<b>Classic PKW TOYOTA TERCEL (82-88)</b>								
	1.3 (AL20) 48 1.5 (AL21) 52 1.5 4WD (AL25)		05.82 05.82 08.82	08.84 08.84 01.88	BA2121			20870 15,0 AKE
<b>Classic PKW VOLKSWAGEN CADDY I (83-92)</b>								
	1.5 1.6 1.6 D 1.8		08.82 08.83 08.82 08.85	07.83 07.92 07.92 07.92	BA2132			20887 19,7 +/Zub VW
	1.5 1.6 1.6 D 1.8		08.82 08.83 08.82 08.85	07.83 07.92 07.92 07.92	BAR12106			239 12,0 10,0
	1.5 1.6 1.6 D 1.8		08.82 08.83 08.82 08.85	07.83 07.92 07.92 07.92	BAH0010	2		L=310
	1.5 1.6 1.6 D 1.8		08.82 14-H-011048 08.83 14-H-011048 08.82 14-H-011048 08.85	07.83	BAW1701		+ GG <sup>1)</sup>	Rz 17,46
	1.6 1.6 D 1.8	14-H-011049 14-H-011049 14-H-011049		07.92 07.92 07.92	BAW1905			Rz 19,05
	1.5 1.6 1.6 D 1.8		08.82 14-M-006000 08.83 14-M-006000 08.82 14-M-006000 08.85	07.83	BAE5006			230 x 40 HEB VW
	1.6 1.6 D 1.8	14-M-006001 14-M-006001 14-M-006001		07.92 07.92 07.92	BAE5006			230 x 40 HEB VW
<b>Classic PKW VOLKSWAGEN CORRADO (88-95)</b>								
	1.8 16V 2.0 2.0 16V 1.8 G60 2.9 VR6		04.89 04.93 08.91 10.88 08.91	07.92 07.95 07.95 09.93 07.95	BA2037			20168 16,3 /S LUC
	1.8 16V 2.0 2.0 16V 2.9 VR6		04.89 04.93 08.91 08.91	07.92 07.95 07.95 07.95	BAR20128			256 20,0 18,0 V L
					BAR22100			280 22,0 20,0 V L
	1.8 16V 1.8 G60		50-M-035000 04.89 50-M-035000 10.88		BAH0014	2		L=330
	1.8 16V 1.8 G60 2.0 2.0 16V 2.9 VR6	50-N-000001 50-N-000001		07.92 09.93 04.93 08.91 07.95	BAH0005	2		L=435
	1.8 16V 1.8 G60 2.0 2.0 16V 2.9 VR6		04.89 10.88 04.93 08.91 08.91	07.92 07.95 07.95 07.95	BA2032			20961 15,2 /S LUC
	1.8 G60 2.9 VR6	50-P-009001 50-P-009001		09.93 07.95	BA2017			20961 17,2 /S LUC
	1.8 16V 1.8 G60 2.0 2.0 16V 2.9 VR6		04.89 10.88 04.93 08.91 08.91	07.92 09.93 07.95 07.95	BAR10111		ohne Sensorring <sup>2)</sup>	226 10,0 8,0
					BAR10203			226 10,0 8,0

<sup>1)</sup> + cast iron / + ghisa / + fonte grise / + fundición de gris

<sup>2)</sup> without sensor ring / senza sensori / sans secours ABS / sin anillo sensor ABS

								
<b>Classic PKW VOLKSWAGEN CORRADO (88-95)</b>								
	1.8 16V 1.8 G60 2.0 2.0 16V 2.9 VR6		04.89 07.92 10.88 09.93 04.93 07.95 08.91 07.95 08.91 07.95		BAH0011 BAH0003  BAH0016 BAH0003	2 2  2 2	am Bremssattel <sup>1)</sup>	L=160 L=160  L=135 L=160
<b>Classic PKW VOLKSWAGEN DERBY/POLO Stufenheck (77-88)</b>								
	1.0 1.1 1.3 1.3 D	..-F-127904 ..-F-127904 ..-F-127904	12.88 12.88 12.88 08.86 12.88		BA2131			20889 17,3 /Zub <b>VW</b>
	1.0 1.1 1.3 1.3 D		10.81 12.88 10.81 12.88 10.81 12.88 08.86 12.88		BAR10151			239 9,9 8,0
	0.9 1.0 1.1 1.3 1.3 D		01.77 09.81 01.77 12.88 01.77 12.88 01.77 12.88 08.86 12.88		BAH0008	2		L=290
	0.9 1.0 1.1 1.3 1.3 D		01.77 09.81 01.77 12.88 01.77 12.88 01.77 12.88 08.86 12.88		BAH0015	2		L=180
	0.9 1.0 1.1 1.3  1.0 1.1 1.3 1.3 D  0.9 1.0 1.1 1.3  1.0 1.1 1.3 1.3 D	    ..-F-127904 ..-F-127904 ..-F-127904  ..-F-127904 ..-F-127904 ..-F-127904  ..-F-127904 ..-F-127904 ..-F-127904  ..-F-127904 ..-F-127904 ..-F-127904	01.77 09.81 10.81 01.77 01.77  12.88 12.88 12.88 08.86 12.88  01.77 09.81 10.81 01.77 01.77  12.88 12.88 12.88 08.86 12.88	- Bremskraftregler <sup>2)</sup> - Bremskraftregler <sup>2)</sup> - Bremskraftregler <sup>2)</sup> - Bremskraftregler <sup>2)</sup>  - Bremskraftregler <sup>2)</sup> - Bremskraftregler <sup>2)</sup> - Bremskraftregler <sup>2)</sup> - Bremskraftregler <sup>2)</sup>  + Bremskraftregler <sup>4)</sup> + Bremskraftregler <sup>4)</sup> + Bremskraftregler <sup>4)</sup> + Bremskraftregler <sup>4)</sup>  + Bremskraftregler <sup>4)</sup> + Bremskraftregler <sup>4)</sup> + Bremskraftregler <sup>4)</sup> + Bremskraftregler <sup>4)</sup>	BAW1401    BAW1501    BAW1701    BAW1905	+ GG <sup>3)</sup>    + GG <sup>3)</sup>    + GG <sup>3)</sup>		Rz 14,29    Rz 15,87    Rz 17,46    Rz 19,05
	0.9 1.0 1.1 1.3 1.3 D		08.78 09.81 10.81 12.88 08.78 12.88 08.78 12.88 08.86 12.88		BAE5003			180 x 31 HEB
<b>Classic PKW VOLKSWAGEN GOLF I Cabriolet (79-93)</b>								
	1.5 1.6 1.6 GLI 1.8		09.79 07.83 08.83 12.92 09.79 07.82 08.82 08.93	+ Faustsättel <sup>5)</sup>	BA2132 BA2133			20887 19,7 +/Zub <b>VW</b> 20887 15,3 +/Zub <b>VW</b>
	1.1 1.5 1.6 1.6 GLI 1.8		01.79 07.83 01.79 07.83 08.83 12.92 07.79 07.82 08.82 08.93		BAR10151 BAR12106 BAR20123			239 9,9 8,0 239 12,0 10,0 239 20,0 18,0 V L
	1.1 1.5 1.6 1.6 GLI 1.8		01.79 07.83 01.79 07.83 08.83 08.93 07.79 07.82 08.82 08.93		BAH0010	2		L=310
	1.1 1.5 1.6 GLI 1.8		01.79 07.83 01.79 07.83 07.79 07.82 08.82 07.83		BAH0015	2		L=180
	1.6 1.8		08.83 07.93 08.83 07.93		BAH0011	2		L=160
	1.1 1.5 1.6 1.6 GLI 1.8  1.1 1.5 1.6 1.6 GLI 1.8 1.8	    15-E-011290 15-E-011290  15-E-011291 15-E-011291	01.79 07.83 01.79 07.83 08.83 07.79 07.82 08.82  01.79 07.83 01.79 07.83 08.83 07.79 07.82 08.82	- Bremskraftregler <sup>2)</sup> - Bremskraftregler <sup>2)</sup> - Bremskraftregler <sup>2)</sup> - Bremskraftregler <sup>2)</sup> - Bremskraftregler <sup>2)</sup>  + Bremskraftregler <sup>4)</sup> + Bremskraftregler <sup>4)</sup> + Bremskraftregler <sup>4)</sup> + Bremskraftregler <sup>4)</sup> + Bremskraftregler <sup>4)</sup>	BAW1401    BAW1701	+ GG <sup>3)</sup>    + GG <sup>3)</sup>		Rz 14,29    Rz 17,46

<sup>1)</sup> on the brake caliper / sulla pinza freno / sur l'étrier de frein / a la pinza de freno













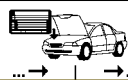





<sup>2)</sup> - brake pressure regulator / - correttore di frenata / - correcteur de freinage / - corrector de frenado

<sup>3)</sup> + cast iron / + ghisa / + fonte grise / + fundición de gris

<sup>4)</sup> + brake pressure regulator / + correttore di frenata / + correcteur de freinage / + corrector de frenado

<sup>5)</sup> + fist type calipers / + pinza freno flottante / + étriers à griffe / + pinza de puno



								
<b>Classic PKW VOLKSWAGEN GOLF I Cabriolet (79-93)</b>								
	1.1 1.5 1.6 1.6 GLI 1.8		01.79 07.83 01.79 07.83 08.83 08.93 07.79 07.82 08.82 08.93		BAE5003			180 x 31 HEB
<b>Classic PKW VOLKSWAGEN GOLF I (74-83)</b>								
	1.5 1.6 1.6 TD 1.6 GTI 1.8 GTI		08.78 10.83 + Faustsättel <sup>1)</sup> 08.78 10.83 + Faustsättel <sup>1)</sup> 03.82 10.83 04.79 07.82 + Faustsättel <sup>1)</sup> 08.82 10.83		BA2132 BA2133			20887 19,7 +/Zub <b>VW</b> 20887 15,3 +/Zub <b>VW</b>
	1.1 1.5 1.6 1.6 TD 1.7 1.1 1.3 1.5 D 1.6 D 1.6 GTI 1.8 GTI		04.74 07.75 02.74 10.83 08.75 10.83 03.82 10.83 08.80 10.83 + $\text{J}$ 08.75 10.83 08.79 10.83 08.76 07.80 08.80 10.83 06.76 07.82 08.82 10.83		BAR12106 BAR10151 BAR20123			239 12,0 10,0 239 9,9 8,0 239 20,0 18,0 V L
	1.1 1.3 1.5 1.5 D 1.6 1.6 D 1.6 GTI 1.6 TD 1.8 GTI		11.78 10.83 08.79 10.83 11.78 10.83 11.78 07.80 11.78 10.83 08.80 10.83 11.78 07.82 03.82 10.83 08.82 10.83		BAH0010	2		L=310
	1.1 1.3 1.5 1.5 D 1.6 1.6 D 1.6 GTI 1.6 TD 1.8 GTI		04.74 10.83 08.79 10.83 02.74 10.83 08.76 07.80 04.74 10.83 08.80 10.83 06.76 07.82 03.82 10.83 08.82 10.83		BAH0011	2		L=160
	1.1 1.3 1.5 1.5 D 1.6 1.6 D 1.6 TD 1.5 1.5 D 1.6 1.6 1.6 D 1.6 GTI 1.7 1.8 GTI		04.74 10.83 08.79 10.83 02.74 10.83 + Schaltgetriebe <sup>3)</sup> 08.76 07.80 + Schaltgetriebe <sup>3)</sup> 04.74 10.83 + Schaltgetriebe/ - $\text{S}$ <sup>4)</sup> 08.80 10.83 + Schaltgetriebe <sup>3)</sup> 03.82 10.83 02.74 10.83 + Automatikgetriebe <sup>5)</sup> 08.76 07.80 + Automatikgetriebe <sup>5)</sup> 04.74 10.83 + $\text{S}$ 04.74 10.83 + Automatikgetriebe <sup>5)</sup> 08.80 10.83 + Automatikgetriebe <sup>5)</sup> 06.76 07.82 08.80 10.83 + $\text{J}$ 08.82 10.83		BAW1401 BAW1701	+ GG <sup>2)</sup>		Rz 14,29 Rz 17,46
	1.1 1.3 1.5 1.5 D 1.6 1.6 D 1.6 GTI 1.6 TD 1.7 1.8 GTI		08.78 10.83 08.79 10.83 08.78 10.83 08.78 07.80 08.78 10.83 08.80 10.83 08.78 07.82 03.82 10.83 08.80 10.83 + $\text{J}$ 08.82 10.83		BAE5003			180 x 31 HEB
<b>Classic PKW VOLKSWAGEN JETTA I (79-83)</b>								
	1.5 1.6 1.6 D 1.6 TD 1.7 1.6 i 1.8		08.79 07.83 + Faustsättel <sup>1)</sup> 08.80 07.83 + Faustsättel <sup>1)</sup> 08.80 07.83 + $\text{J}$ / + Faustsättel <sup>6)</sup> 03.82 07.83 08.80 07.83 + $\text{J}$ 08.79 07.82 08.82 07.83		BA2132 BA2133			20887 19,7 +/Zub <b>VW</b> 20887 15,3 +/Zub <b>VW</b>
	1.1 1.3 1.6 D 1.5 1.6 1.6 D 1.6 TD 1.7 1.6 i 1.8		08.79 07.83 08.79 07.83 08.80 07.83 - $\text{J}$ 08.79 07.83 08.80 07.83 08.80 07.83 + $\text{J}$ 03.82 07.83 08.80 07.83 + $\text{J}$ 08.79 07.82 08.82 07.83		BAR10151 BAR12106 BAR20123			239 9,9 8,0 239 12,0 10,0 239 20,0 18,0 V L

<sup>1)</sup> + fist type calipers / + pinza freno flottante / + étriers à griffe / + pinza de puno













<sup>2)</sup> + cast iron / + ghisa / + fonte grise / + fundición de gris

<sup>3)</sup> + manual transmission / + scatola cambio velocità / + transmission mécanique / + cambio de velocidad



<sup>4)</sup> + manual transmission/ -  $\text{S}$  / + scatola camb.velocità/ -  $\text{S}$  / + transmission mécanique/ -  $\text{S}$  / + cambio de velocidad/ -  $\text{S}$

<sup>5)</sup> + autom.transmission / + scatola cambio automatico / + transmission automatique / + cambio automático

<sup>6)</sup> +  $\text{J}$  / + fist type calipers / +  $\text{J}$  / + pinza flottante / +  $\text{J}$  / + étriers à griffe / +  $\text{J}$  / + pinza de puno

								
<b>Classic PKW VOLKSWAGEN JETTA I (79-83)</b>								
	1.1 1.3 1.5 1.6 1.6 D 1.6 i 1.6 TD 1.7 1.8			08.79 07.83 08.79 07.83 08.79 07.83 08.80 07.83 08.80 07.83 08.79 07.82 03.82 07.83 08.80 07.83 + ① 08.82 07.83		BAH0010	2	L=310
	1.1 1.3 1.5 1.6 1.6 D 1.6 i 1.6 TD 1.7 1.8			08.79 07.83 08.79 07.83 08.79 07.83 08.80 07.83 08.80 07.83 08.79 07.82 03.82 07.83 08.80 07.83 + ① 08.82 07.83		BAH0011	2	L=160
	1.1 1.3 1.5 1.6 1.6 D 1.6 TD			08.79 07.83 08.79 07.83 08.79 07.83 + Schaltgetriebe ② 08.80 07.83 + Schaltgetriebe ② 08.80 07.83 + Schaltgetriebe ② 03.82 07.83		BAW1401	+ GG ①	Rz 14,29
	1.5 1.6 1.6 D 1.6 i 1.7 1.8			08.79 07.83 + Automatikgetriebe ③ 08.80 07.83 + Automatikgetriebe ③ 08.80 07.83 + Automatikgetriebe ③ 08.79 07.82 08.80 07.83 + ① 08.82 07.83		BAW1701	+ GG ①	Rz 17,46
	1.1 1.3 1.5 1.6 1.6 D 1.6 i 1.6 TD 1.7 1.8			08.79 07.83 08.79 07.83 08.79 07.83 08.80 07.83 08.80 07.83 08.79 07.82 03.82 07.83 08.80 07.83 + ① 08.82 07.83		BAE5003		180 x 31 HEB

























**Classic PKW VOLKSWAGEN JETTA II (84-92)**

	1.3 1.3 1.3 1.6 1.6 D 1.6 D 1.6 D		16-E-855000 08.83 08.83 07.86 08.83 07.84 - ABS 03.86 07.86 16-E-855000 01.84 01.84 07.86 - ① 08.86 07.92 + Schaltgetriebe ②		BA2131		20889 17,3 /Zub	VW
	1.3 1.3 1.6 1.6 1.6 D 1.6 D 1.6 D 1.6 TD 1.8 1.8 1.8 Syncro	53 16-E-855001 55 16-E-855001 62 66	08.89 07.86 08.89 07.92 + ABS 08.86 07.92 01.84 07.86 07.86 - ① 01.84 07.86 + ① 08.86 07.87 + Automatikgetriebe ③ 01.84 07.92 08.86 07.92 - ABS 08.84 07.92 - ABS 08.87 07.92		BA2132		20887 19,7 +/Zub	VW
	1.8 1.8 1.8 1.8 1.8 1.8 16V 1.8 16V	62 16-JH560001 66 16-JH560001 77 79 82	07.92 + ABS 07.92 + ABS 08.88 07.92 + ① 08.85 07.92 01.84 07.92 1G-KW240000 08.86 1G-KB075000 08.86		BA2133		20887 15,3 +/Zub	VW
	1.8 16V 1.8 16V	1G-KW240001 1G-KB075001	07.92 07.92		BA2037		20168 16,3 /S	LUC
	1.3 1.3 1.3 1.6 1.6 D 1.6 D 1.6 D		16-E-855000 08.83 08.83 07.86 08.86 07.92 - ABS 03.86 07.86 16-E-855000 01.84 01.84 07.86 - ① 08.86 07.92 + Schaltgetriebe ②		BAR10151		239 9,9 8,0	
	1.3 1.3 1.6 1.6 1.6 D 1.6 D 1.6 D 1.6 TD 1.8 1.8 1.8 Syncro	53 16-E-855001 55 16-E-855001 62 66	07.86 08.89 07.92 + ABS 08.86 07.92 01.84 07.86 07.86 - ① 01.84 07.86 + ① 08.86 07.92 + Automatikgetriebe ③ 01.84 07.92 08.86 07.92 - ABS 08.84 07.92 - ABS 08.87 07.92		BAR12106		239 12,0 10,0	

1) + cast iron / + ghisa / + fonte grise / + fundición de gris

2) + manual transmission / + scatola cambio velocità / + transmission mécanique / + cambio de velocidad

3) + autom.transmission / + scatola cambio automatico / + transmission automatique / + cambio automático

								
<b>Classic PKW VOLKSWAGEN JETTA II (84-92)</b>								
	1.8 1.8 1.8 1.8 1.8 1.8 16V 1.8 16V	62 16-JH560001 66 16-JH560001 77 79 82		07.92 + ABS 07.92 + ABS 08.88 07.92 +  08.85 07.92 01.84 07.92 1G-KW240000 08.86 1G-KB075000 08.86		BAR20123		239 20,0 18,0 V L
	1.8 16V 1.8 16V	1G-KW240001 1G-KB075001		07.92 + ABS 07.92 + ABS		BAR20128		256 20,0 18,0 V L
	1.3 1.6 1.6 D 1.6 TD 1.8 1.8 16V 1.8 16V 1.8 Syncro			08.83 07.92 01.84 07.92 01.84 07.92 01.84 07.92 01.84 07.92 1G-KW240000 02.86 1G-KB075000 02.86 08.87 07.92		BAH0010	2	L=310
	1.8 1.8 1.8 1.8 16V 1.8 GT	62 16-JH480001 66 16-JH480001 82		07.92 + ABS 07.92 + ABS 01.84 07.92 08.86 07.92 08.85 07.92		BA2032		20961 15,2 /S LUC
	1.8 1.8 1.8 1.8 16V 1.8 GT	62 16-JH480001 66 16-JH480001 82		07.92 + ABS 07.92 + ABS 01.84 07.92 08.86 07.92 08.85 07.92		BAR10111	ohne Sensorring <sup>1)</sup>	226 10,0 8,0
	1.3 1.6 1.6 D 1.6 TD 1.8 1.8			08.83 07.88 01.84 07.88 01.84 07.88 01.84 07.88 08.86 07.88 - ABS 08.84 07.88 - ABS		BAH0015 BAH0011	2 2	L=180 L=160
	1.3 1.6 1.6 D 1.6 TD 1.8 1.8 1.8 Syncro	62 66		08.88 07.92 08.88 07.92 08.88 07.92 08.88 07.92 08.88 07.92 - ABS 08.88 07.92 - ABS 08.87 07.92		BAH0011	2	L=160
	1.8 1.8 1.8 1.8 16V	62 16-JH480001 66 16-JH480001 82		07.92 + ABS 07.92 + ABS 01.84 07.92 08.86 07.92		BAH0003	2	L=160
	1.3 1.6 1.6 D 1.6 TD 1.8 1.8 1.8			08.83 07.92 - Bremskraftregler <sup>2)</sup> 01.84 07.92 - Bremskraftregler <sup>2)</sup> 01.84 07.92 - Bremskraftregler <sup>2)</sup> 01.84 07.92 - Bremskraftregler <sup>2)</sup> 08.86 07.92 - Bremskraftregler <sup>2)</sup> 08.84 07.92 - Bremskraftregler <sup>2)</sup> 1G-KW593279 08.88 + 		BAW1401	+ GG <sup>3)</sup>	Rz 14,29
	1.3 1.6 1.6 D 1.6 TD 1.8 1.8 1.8	62 66 77 1G-KW593280		08.83 07.92 + Bremskraftregler <sup>4)</sup> 01.84 07.92 + Bremskraftregler <sup>4)</sup> 01.84 07.92 + Bremskraftregler <sup>4)</sup> 01.84 07.92 + Bremskraftregler <sup>4)</sup> 08.86 07.92 + Bremskraftregler <sup>4)</sup> 08.84 07.92 + Bremskraftregler <sup>4)</sup> 07.92 + 		BAW1701	+ GG <sup>3)</sup>	Rz 17,46
	1.8 Syncro			08.87 07.92		BAW1905		Rz 19,05
	1.3 1.6 1.6 D 1.6 TD 1.8 1.8 1.8			08.83 07.92 01.84 07.92 01.84 07.92 01.84 07.92 -  08.86 07.92 - ABS 08.84 07.92 - ABS 1G-KW593279 08.88 - ABS + 		BAE5003		180 x 31 HEB
	1.6 TD 1.8	62 77 1G-KW593280		08.89 07.92 +  07.92 + ABS/ + 		BAE5001		200 x 40 HEB VW
	1.8 Syncro			08.87 07.92		BAE5006		230 x 40 HEB VW
<b>Classic PKW VOLKSWAGEN PASSAT Limousine (85-88)</b>								
	1.3 1.6 1.6 D 1.6 TD 1.8			08.84 07.86 08.84 03.88 08.84 03.88 08.84 03.88 08.84 03.88		BA2132		20887 19,7 +/Zub VW
	2.0 2.2	85		08.84 03.88 08.85 03.88		BA2133		20887 15,3 +/Zub VW
	2.2	100		01.85 03.88		BA2037		20168 16,3 /S LUC
	1.3 1.6 1.6 D 1.6 TD 1.8			08.84 07.86 08.84 03.88 08.84 03.88 08.84 03.88 08.84 03.88		BAR12106		239 12,0 10,0

<sup>1)</sup> without sensor ring / senza sensori / sans secours ABS / sin anillo sensor ABS

<sup>2)</sup> - brake pressure regulator / - correttore di frenata / - correcteur de freinage / - corrector de frenado

<sup>3)</sup> + cast iron / + ghisa / + fonte grise / + fundición de gris

<sup>4)</sup> + brake pressure regulator / + correttore di frenata / + correcteur de freinage / + corrector de frenado

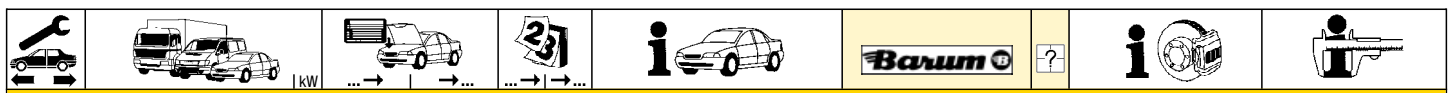













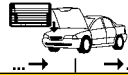







**Classic PKW VOLKSWAGEN PASSAT Limousine (85-88)**

	2.0 2.2	85	08.84 08.85	03.88 03.88	BAR20123		239 20,0 18,0 V L
	2.2	100	01.85	03.88	BAR20128		256 20,0 18,0 V L
	1.3 1.6 1.6 D 1.6 TD 1.8 2.0 2.2		08.84 08.84 08.84 08.84 08.84 08.84 08.85	07.86 03.88 03.88 03.88 03.88 03.88 03.88	BAH0010	2	L=310
	2.2	100	01.85	03.88	BA2032		20961 15,2 /S LUC
	2.2	100	01.85	03.88	BAR10111	ohne Sensorring <sup>1)</sup>	226 10,0 8,0
	1.3 1.6 1.6 D 1.6 TD 1.8		08.84 08.84 08.84 08.84 08.84	07.86 03.88 03.88 03.88 03.88	BAH0011	2	L=160
	1.6 1.6 D 1.6 TD 1.8 2.0 2.2		08.84 08.84 08.84 08.84 08.84 08.85	03.88 03.88 03.88 03.88 03.88 03.88	BAH0015 BAH0011		L=180 L=160
	2.2	85	01.85	03.88	BAH0003	2	L=160
	2.2	100	01.85	03.88	BAH0003	2	L=160
	1.3 1.6 1.8		08.84 08.84 08.84	07.86 03.88 03.88	BAW1501	+ GG <sup>5)</sup>	Rz 15,87
	1.6 D		08.84	03.88	BAW1401	+ GG <sup>5)</sup>	Rz 14,29
	1.3 1.6 1.6 D 1.6 D 1.6 TD 1.8 1.8 2.0 2.2		08.84 08.84 08.84 08.84 08.84 08.84 08.84 08.84 08.85	07.86 03.88 03.88 03.88 03.88 03.88 03.88 03.88 03.88	BAW1701	+ GG <sup>5)</sup>	Rz 17,46
	1.3 1.6 1.6 D 1.8		08.84 08.84 08.84 08.84	07.86 03.88 03.88 03.88	BAE5003		180 x 31 HEB

**Classic PKW VOLKSWAGEN PASSAT Variant (73-84)**

	1.3 1.5 D 1.6 1.6 D 1.6 i 1.6 TD 1.8		02.80 02.80 02.80 02.79 02.80 12.81 01.83	07.84 07.80 07.84 07.84 07.80 07.84 07.84	BA2132		20887 19,7 +/Zub VW
	1.8 i 1.9 2.0 2.2		12.83 01.81 08.83 01.81	07.84 07.83 07.84 07.83	BA2133		20887 15,3 +/Zub VW
	1.3 1.5 1.5 D 1.6 1.6 D 1.6 i 1.6 TD 1.8		05.73 05.73 08.77 09.75 02.79 06.78 12.81 01.83	07.84 08.75 07.80 07.84 07.84 07.80 07.84 07.84	BAR12106		239 12,0 10,0
	1.8 i 1.9 2.0 2.2		12.83 01.81 08.83 01.81	07.84 07.83 07.84 07.83	BAR20123		239 20,0 18,0 V L
	1.3 1.5 1.5 D 1.6 1.6 D 1.6 i 1.6 TD 1.8 1.9 2.0 2.2		05.73 05.73 08.77 09.75 02.79 06.78 12.81 01.83 01.81 08.83 01.81	07.84 08.75 07.80 07.84 07.84 07.80 07.84 07.84 07.83 07.84 07.83	BAH0010		L=310















<sup>1)</sup> without sensor ring / senza sensori / sans secours ABS / sin anillo sensor ABS  
<sup>2)</sup> + manual transmission / + scatola cambio velocità / + transmission mécanique / + cambio de velocidad  
<sup>3)</sup> + autom.transmission / + scatola cambio automatico / + transmission automatique / + cambio automático  
<sup>4)</sup> - heavy duty brake / - freno rinforzato / - frein renforcé / - freno reforzado  
<sup>5)</sup> + cast iron / + ghisa / + fonte grise / + fundición de gris  
<sup>6)</sup> - heavy duty br./+ manual trans. / - fr.rinforzato/+ scatola camb.velocità / - frein renforcé/+ transm.mécanique / - freno reforzado/+ camb.velocidad  
<sup>7)</sup> + heavy duty brake / + freno rinforzato / + frein renforcé / + freno reforzado  
<sup>8)</sup> + heavy duty br./+manual transm. / + fr.rinforzato/+ scatola camb.velocità / + frein renforcé / + transm.mécanique / + freno reforzado/+ camb.de velocidad  
<sup>9)</sup> + fist type calipers / + pinza freno flottante / + étriers à griffe / + pinza de puno  
<sup>10)</sup> + / + fist type caliper / + / + pinza flottante / + / + étriers à griffe / + / + pinza de puno

								
<b>Classic PKW VOLKSWAGEN PASSAT Variant (73-84)</b>								
	1.3		05.73	07.80	BAH0015	2		L=180
	1.5		05.73	08.75				
	1.5 D		08.77	07.80				
	1.6		09.75	07.80				
	1.6 i		06.78	07.80	+ s j			
	1.3		08.80	07.84	BAH0015	2		L=180
	1.6		08.80	07.84	BAH0011	2		L=160
	1.6 D		02.79	07.84				
	1.6 TD		12.81	07.84				
	1.9		01.81	07.83				
2.0		08.83	07.84					
2.2		01.81	07.83	+ s				
	1.9		01.81	07.81	BAW1501		+ GG <sup>1)</sup>	Rz 15,87
	2.2		01.81	07.81	+ s			
	1.3		05.73	07.84	BAW1701		+ GG <sup>1)</sup>	Rz 17,46
	1.5		05.73	08.75				
	1.5 D		08.77	07.80				
	1.6		09.75	07.84				
	1.6 D		02.79	07.84				
	1.6 i		06.78	07.80	+ s j			
	1.6 TD		12.81	07.84				
	1.8		01.83	07.84				
1.9		08.81	07.83					
2.0		08.83	07.84					
2.2		08.81	07.83	+ s				
<b>Classic PKW VOLKSWAGEN PASSAT Variant (85-88)</b>								
	1.3		08.84	07.86	BA2132			20887 19,7 +/Zub VW
	1.6		08.84	03.88				
	1.6 D		08.84	03.88				
	1.6 TD		08.84	03.88				
	1.8		08.84	03.88				
	2.0		08.84	03.88	BA2133			20887 15,3 +/Zub VW
	2.2	85	08.85	03.88				
	1.8 Syncro		01.86	07.88	BA2037			20168 16,3 /S LUC
	2.0 Syncro		08.84	07.88				
	2.2	100	01.85	03.88				
	2.2 Syncro		08.84	07.88				
	1.3		08.84	07.86	BAR12106			239 12,0 10,0
	1.6		08.84	03.88				
	1.6 D		08.84	03.88				
	1.6 TD		08.84	03.88				
	1.8		08.84	03.88				
	2.0		08.84	03.88	BAR20123			239 20,0 18,0 V L
	2.2	85	08.85	03.88				
	1.8 Syncro		01.86	07.88	BAR20128			256 20,0 18,0 V L
	2.0 Syncro		08.84	07.88				
	2.2	100	01.85	03.88				
	2.2 Syncro		08.84	07.88				
	1.3		08.84	07.86	BAH0010			L=310
	1.6		08.84	03.88				
	1.6 D		08.84	03.88				
	1.6 TD		08.84	03.88				
	1.8		08.84	03.88				
	1.8 Syncro		01.86	07.88				
	2.0		08.84	03.88				
2.0 Syncro		08.84	07.88					
2.2		01.85	03.88					
2.2 Syncro		08.84	07.88					
	1.8 Syncro		01.86	07.88	BA2032			20961 15,2 /S LUC
	2.0 Syncro		08.84	07.88				
	2.2	100	01.85	03.88				
	2.2 Syncro		08.84	07.88				
	2.2	100	01.85	03.88	BAR10111		ohne Sensorring <sup>2)</sup>	226 10,0 8,0
	1.8 Syncro		01.86	07.88	BAR10151			239 9,9 8,0
	2.0 Syncro		08.84	07.88				
2.2 Syncro		08.84	07.88					
	1.3		08.84	07.86	BAH0015	2		L=180
	1.6		08.84	03.88	BAH0011	2		L=160
	1.6 D		08.84	03.88				
	1.6 TD		08.84	03.88				
	1.8		08.84	03.88				
	2.0		08.84	03.88				
	2.2	85	08.85	03.88				
2.2	100	01.85	03.88	BAH0003	2		L=160	
	1.8 Syncro		01.86	07.88	BAH0003	2	am Bremssattel <sup>3)</sup>	L=160
	2.0 Syncro		08.84	07.88				
	2.2 Syncro		08.84	07.88				
	1.3		08.84	07.86	BAW1701		+ GG <sup>1)</sup>	Rz 17,46
	1.6		08.84	03.88				
	1.6 D		08.84	03.88				
	1.6 TD		08.84	03.88				
	1.8		08.84	03.88				
	2.0		08.84	03.88				
	2.2	85	08.85	03.88				









































<sup>1)</sup> + cast iron / + ghisa / + fonte grise / + fundición de gris

<sup>2)</sup> without sensor ring / senza sensori / sans secours ABS / sin anillo sensor ABS

<sup>3)</sup> on the brake caliper / sulla pinza freno / sur l'étrier de frein / a la pinza de freno

									
<b>Classic PKW VOLKSWAGEN PASSAT/SANTANA Limousine (73-84)</b>									
	1.3		08.82	07.84	+ Schaltgetriebe <sup>1)</sup>	BA2132		20887 19,7 +/Zub	VW
	1.6 D		09.81	07.84					
	1.6 TD		12.81	07.84					
	1.8 i		01.83	07.84					
	1.5 D		02.80	07.80	+ Automatikgetriebe <sup>2)</sup>	BA2132		20887 19,7 +/Zub	VW
	1.6		02.80	07.84	+ Schaltgetriebe <sup>1)</sup>				
	1.6		02.80	07.84	+ Automatikgetriebe <sup>2)</sup>				
	1.6 D		08.80	07.84	+ Automatikgetriebe <sup>2)</sup>				
	1.6 i		02.80	07.80	+ Automatikgetriebe <sup>2)</sup>				
	1.6 TD		12.81	07.84	+ Automatikgetriebe <sup>2)</sup>				
	1.8 GT		12.83	07.84	+ Automatikgetriebe <sup>2)</sup>				
	1.8 i		01.83	07.84	+ Automatikgetriebe <sup>2)</sup>				
1.9		01.81	07.83	+ Automatikgetriebe <sup>2)</sup>					
2.0		08.83	07.84	+ Automatikgetriebe <sup>2)</sup>					
1.6 i		09.75	07.80	+ $\text{\textcircled{S}}$ $\text{\textcircled{J}}$	BA2133		20887 15,3 +/Zub	VW	
1.6 i		02.79	07.80						
1.8 GT		12.83	07.84						
1.9		01.81	07.83						
2.0		08.83	07.84						
2.2		01.81	07.83	+ $\text{\textcircled{S}}$					
	1.3		05.73	07.82	BAR10151		239 9,9 8,0		
	1.5 D		08.77	07.80					
	1.6 D		08.80	08.81					
	1.3		08.82	07.84	BAR12106		239 12,0 10,0		
	1.5		05.73	08.75					
	1.6		09.75	07.84					
	1.6 D		09.81	07.84					
	1.6 TD		12.81	07.84					
	1.8 i		01.83	07.84					
	1.8 i		01.83	07.84					
	1.6 i		09.75	07.80	+ $\text{\textcircled{S}}$ $\text{\textcircled{J}}$	BAR20123		239 20,0 18,0 V L	
	1.6 i		02.79	07.80					
1.8 GT		12.83	07.84						
1.9		01.81	07.83						
2.0		08.83	07.84						
2.2		01.81	07.83	+ $\text{\textcircled{S}}$					
	1.3		05.73	07.84	BAH0010		L=310		
	1.5		05.73	08.75					
	1.5 D		08.77	07.80					
	1.6		09.75	07.84					
	1.6 D		08.80	07.84					
	1.6 i		09.75	07.80					
	1.6 TD		12.81	07.84					
	1.8 GT		12.83	07.84					
	1.8 i		01.83	07.84					
	1.9		01.81	07.83					
	2.0		08.83	07.84					
	2.2		01.81	07.83					+ $\text{\textcircled{S}}$
	1.3		05.73	07.80	BAH0015	2	L=180		
	1.5		05.73	08.75					
	1.5 D		08.77	07.80					
	1.6		09.75	07.80					
	1.6 i		09.75	07.80					
	1.3		08.80	07.84	BAH0011	2	L=160		
	1.6		08.80	07.84					+ Schaltgetriebe <sup>1)</sup>
	1.6 D		08.80	07.84					+ Schaltgetriebe <sup>1)</sup>
	1.6		08.80	07.84					+ Automatikgetriebe <sup>2)</sup>
	1.6 D		08.80	07.84					+ Automatikgetriebe <sup>2)</sup>
	1.6 TD		12.81	07.84					
	1.9		01.81	07.83					
2.0		08.83	07.84						
2.2		01.81	07.83	+ $\text{\textcircled{S}}$					
	1.3		05.73	07.84	BAW1401		+ GG <sup>3)</sup>	Rz 14,29	
	1.5		05.73	08.75					+ Schaltgetriebe <sup>1)</sup>
	1.5 D		08.77	07.80					+ Schaltgetriebe <sup>1)</sup>
	1.6		09.75	07.81					+ Schaltgetriebe <sup>1)</sup>
	1.6 D		08.80	07.81	+ Schaltgetriebe <sup>1)</sup>				
	1.6		08.81	07.84	+ Schaltgetriebe <sup>1)</sup>	BAW1501	+ GG <sup>3)</sup>	Rz 15,87	
	1.6 D		08.81	07.84	+ Schaltgetriebe <sup>1)</sup>				
	1.8 i		01.83	07.84	- GT/ + Schaltgetriebe <sup>4)</sup>				
	1.9		01.81	07.81					
	2.2		01.81	07.81	+ $\text{\textcircled{S}}$				
	1.5		05.73	08.75	+ Automatikgetriebe <sup>2)</sup>	BAW1701	+ GG <sup>3)</sup>	Rz 17,46	
	1.5 D		08.77	07.80	+ Automatikgetriebe <sup>2)</sup>				
1.6		09.75	07.84	+ Automatikgetriebe <sup>2)</sup>					
1.6 D		08.80	07.84	+ Automatikgetriebe <sup>2)</sup>					
1.6 i		09.75	07.80						
1.6 TD		12.81	07.84						
1.8 i		01.83	07.84	- GT/ + Automatikgetriebe <sup>5)</sup>					
1.9		08.81	07.83						
2.0		08.83	07.84						
2.2		08.81	07.83	+ $\text{\textcircled{S}}$					
	1.3		08.78	07.84	BAE5003		180 x 31 HEB		
	1.5 D		08.78	07.80					+ Schaltgetriebe <sup>1)</sup>
	1.6		08.78	07.84					+ Schaltgetriebe <sup>1)</sup>
	1.6 D		08.80	07.84					+ Schaltgetriebe <sup>1)</sup>

<sup>1)</sup> + manual transmission / + scatola cambio velocità / + transmission mécanique / + cambio de velocidad  
<sup>2)</sup> + autom.transmission / + scatola cambio automatico / + transmission automatique / + cambio automático  
<sup>3)</sup> + cast iron / + ghisa / + fonte grise / + fundición de gris  
<sup>4)</sup> - GT/ + manual transm. / - GT/+ scatola cambio velocità / - GT/ + transmission mécanique / - GT/ + cambio de velocidad  
<sup>5)</sup> - GT/ + autom.transmission / - GT/+ scatola cambio autom. / - GT/ + transmission automatique / - GT/ + cambio automático





								
<b>Classic PKW VOLKSWAGEN POLO I (75-81)</b>								
	0.9 1.1 1.3		04.75 09.81 04.75 09.81 12.76 09.81		BAH0008	2		L=290
	0.9 1.1 1.3		04.75 09.81 04.75 09.81 12.76 09.81		BAH0015	2		L=180
	0.9 1.1 1.3		04.75 09.81 - Bremskraftregler <sup>1)</sup> 04.75 09.81 - Bremskraftregler <sup>1)</sup> 12.76 09.81 - Bremskraftregler <sup>1)</sup>		BAW1401	+ GG <sup>2)</sup>		Rz 14,29
	0.9 1.1 1.3		04.75 09.81 + Bremskraftregler <sup>3)</sup> 04.75 09.81 + Bremskraftregler <sup>3)</sup> 12.76 09.81 + Bremskraftregler <sup>3)</sup>		BAW1701	+ GG <sup>2)</sup>		Rz 17,46
	0.9 1.1 1.3		08.78 09.81 08.78 09.81 08.78 09.81		BAE5003			180 x 31 HEB
<b>Classic PKW VOLKSWAGEN SCIROCCO I (74-83)</b>								
	1.1 1.3 1.5 1.6 1.7		08.78 07.80 + Faustsättel <sup>4)</sup> 08.79 07.83 + Faustsättel <sup>4)</sup> 08.78 07.83 + Faustsättel <sup>4)</sup> 08.78 07.83 + Faustsättel <sup>4)</sup> 08.80 07.83 +  / + Faustsättel <sup>5)</sup>		BA2132			20887 19,7 +/Zub <b>VW</b>
	1.6 i 1.8		04.79 07.82 + Faustsättel <sup>4)</sup> 08.82 07.83		BA2133			20887 15,3 +/Zub <b>VW</b>
	1.1 1.3 1.5 1.6 1.7		01.74 07.80 08.79 07.83 01.74 07.83 01.75 07.83 08.80 07.83 + 		BAR12106			239 12,0 10,0
	1.6 i 1.8		01.76 07.82 08.82 07.83		BAR20123			239 20,0 18,0 V L
	1.1 1.3 1.5 1.6 1.7 1.8		11.78 07.80 08.79 07.83 11.78 07.83 11.78 07.83 08.80 07.83 + 		BAH0010	2		L=310
	1.1 1.3 1.5 1.6 1.7 1.8		01.74 07.80 08.79 07.83 01.74 07.83 01.75 07.83 08.80 07.83 + 		BAH0011	2		L=160
	1.1 1.3 1.5 1.6		01.74 07.80 08.79 07.81 01.74 07.81 + Schaltgetriebe <sup>6)</sup> 01.75 07.81 + Schaltgetriebe <sup>6)</sup>		BAW1401	+ GG <sup>2)</sup>		Rz 14,29
	1.3 1.5 1.6 1.6 i 1.7 1.8		08.81 07.83 01.74 07.81 + Automatikgetriebe <sup>7)</sup> 01.75 07.81 + Automatikgetriebe <sup>7)</sup> 01.76 07.82 08.80 07.83 + 		BAW1701	+ GG <sup>2)</sup>		Rz 17,46
	1.1 1.3 1.5 1.6 1.6 i 1.7 1.8		08.78 07.80 08.79 07.83 08.78 07.83 01.77 07.83 +  08.78 07.82 08.80 07.83 + 		BAE5003			180 x 31 HEB
<b>Classic PKW VOLKSWAGEN SCIROCCO II (84-92)</b>								
	1.3 1.6 1.8		08.83 07.84 08.83 07.92 08.83 07.92		BA2132			20887 19,7 +/Zub <b>VW</b>
	1.8 16V		10.85 07.92		BA2133			20887 15,3 +/Zub <b>VW</b>
	1.3 1.6 1.8		08.83 07.84 08.83 07.92 08.83 07.92		BA2037			20168 16,3 /S <b>LUC</b>
	1.3 1.6 1.8		08.83 07.84 08.83 07.92 08.83 07.92		BAR12106			239 12,0 10,0
	1.8 16V		10.85 07.92		BAR20123			239 20,0 18,0 V L
	1.8 16V		10.85 07.92		BAR20128			256 20,0 18,0 V L
	1.3 1.6 1.8		08.83 07.84 08.83 07.92 08.83 07.92		BAH0010	2		L=310
	1.8 16V		10.85 07.92		BA2032			20961 15,2 /S <b>LUC</b>
	1.8 16V		10.85 07.92		BAR10111		ohne Sensorring <sup>8)</sup>	226 10,0 8,0
	1.3 1.6 1.8		08.83 07.84 08.83 07.92 08.83 07.92		BAH0015	2		L=180

<sup>1)</sup> - brake pressure regulator / - correttore di frenata / - correcteur de freinage / - corrector de frenado

<sup>2)</sup> - cast iron / + ghisa / + fonte grise / + fundición de gris

<sup>3)</sup> - brake pressure regulator / + correttore di frenata / + correcteur de freinage / + corrector de frenado

















<sup>4)</sup> - fist type calipers / + pinza freno flottante / + étriers à griffe / + pinza de puno

<sup>5)</sup> -  / + fist type calipers / +  / + pinza flottante / +  / + étriers à griffe / +  / + pinza de puno

<sup>6)</sup> - manual transmission / + scatola cambio velocità / + transmission mécanique / + cambio de velocidad



















<sup>7)</sup> - autom.transmission / + scatola cambio automatico / + transmission automatique / + cambio automático

<sup>8)</sup> without sensor ring / senza sensori / sans secours ABS / sin anillo sensor ABS



















								
<b>Classic PKW VOLKSWAGEN SCIROCCO II (84-92)</b>								
	1.8 16V		10.85	07.92	BAH0003	2		L=160
	1.3 1.6 1.8		53-E-022074 08.83 53-E-022074 08.83		BAW1401		+ GG <sup>2)</sup>	Rz 14,29
	1.3 1.6 1.8		08.83 07.84 08.83 07.92 08.83 07.92	+ Bremskraftregler <sup>3)</sup> + Bremskraftregler <sup>3)</sup> + Bremskraftregler <sup>3)</sup>	BAW1701		+ GG <sup>2)</sup>	Rz 17,46
	1.3 1.6 1.8		08.83 07.84 08.83 07.92 08.83 07.92		BAE5003			180 x 31 HEB
<b>Classic PKW VOLKSWAGEN TRANSPORTER (Typ 2) (79-92)</b>								
	1.6 D 1.6 TD 1.6 TD Syncro 1.7 D 1.9 1.9 Syncro 2.0 2.1 2.1 Syncro		08.85 07.87 08.85 09.92 03.86 09.92 08.85 09.92 08.85 09.92 11.84 09.92 08.85 04.86 08.85 09.92 08.85 09.92	+ Faustsättel <sup>4)</sup> + Faustsättel <sup>4)</sup>	BA2025			20979 19,7 / S LUC
	1.6 1.6 D 1.6 TD 1.6 TD Syncro 1.7 D 1.9 1.9 Syncro 2.0 2.1 2.1 Syncro		07.79 12.82 01.81 07.87 08.84 09.92 03.86 09.92 10.86 09.92 08.82 09.92 11.84 09.92 05.79 04.86 08.85 09.92 08.85 09.92		BAH0015	2		L=180
<b>Classic PKW VOLVO 240 Kombi (74-93)</b>								
	2.0 2.0 2.0 2.0 2.0 2.1 2.1 2.1 2.1 2.1 2.1 T 2.3 2.3 2.3 2.3 2.3 2.3 2.3 2.3 2.3 i Katalysator 2.3 i Katalysator 2.4 D 2.4 D 2.7 2.8 2.8	60 66 71 76 86 100 71 74 79 80 90 114 81 82 83 85 96 98 100 85 100 58 60 104 95 114	08.74 07.76 08.76 01.82 08.80 12.84 08.84 07.85 08.83 07.93 10.82 08.84 08.74 07.75 08.75 07.80 08.80 07.84 08.80 07.84 08.74 07.79 08.80 07.85 08.84 07.86 08.80 07.84 08.86 07.87 08.86 12.88 08.84 07.85 08.84 12.88 01.83 12.84 08.86 07.93 08.91 07.92 08.88 08.93 04.79 08.93 08.79 07.80 10.81 09.82 10.80 09.82		BAR10189			281 9,6 8,4
<b>Classic PKW VOLVO 240 Limousine (74-93)</b>								
	2.0 2.0 2.0 2.0 2.1 2.1 2.1 2.1 2.1 2.1 T 2.3 2.3 2.3 2.3 2.3 2.3 2.3 2.3 2.3 2.3 2.3 i Katalysator 2.4 D 2.4 D 2.7	60 66 71 76 100 71 74 79 90 114 81 82 83 85 96 98 100 103 85 58 60 104	08.74 07.76 08.76 07.79 09.78 08.83 08.84 07.85 10.82 08.84 08.74 07.75 08.75 07.80 08.80 07.84 08.74 07.80 08.80 07.84 08.84 07.86 08.80 07.84 08.86 07.87 08.86 12.88 08.83 07.85 08.84 12.89 08.80 07.83 08.78 07.80 08.86 07.93 08.87 08.93 08.78 07.85 08.79 07.80		BAR10189			281 9,6 8,4

1) - brake pressure regulator / - correttore di frenata / - correcteur de freinage / - corrector de frenado  
2) + cast iron / + ghisa / + fonte grise / + fundición de gris  
3) + brake pressure regulator / + correttore di frenata / + correcteur de freinage / + corrector de frenado  
4) + fist type calipers / + pinza freno flottante / + étriers à griffe / + pinza de puno



        									
<b>Classic PKW VOLVO 260 Coupe (77-78)</b>									
	2.7	103		08.77	07.78		BAR10189		281 9,6 8,4
<b>Classic PKW VOLVO 260 Kombi (75-82)</b>									
	2.7	92		08.75	07.77		BAR10189		281 9,6 8,4
	2.7	103		07.75	07.82				
	2.7	109		10.78	07.82				
	2.8	114		08.80	07.82				
<b>Classic PKW VOLVO 260 Limousine (74-82)</b>									
	2.7	92		08.76	07.82		BAR10189		281 9,6 8,4
	2.7	103		08.74	07.80				
	2.7	109		08.78	07.82				
	2.8	95		08.80	07.82				
	2.8	114		08.80	07.82				
<b>Classic PKW VOLVO 740 Kombi (85-92)</b>									
	2.0	82		09.90	07.91 + ABS		BA2181		20164 18,2 LUC
	2.0	89		09.90	07.92 + ABS				
	2.3	85		09.90	07.92 + ABS				
	2.3	111		09.90	07.92 + ABS				
	2.4 TD	80		09.90	07.92 + ABS				
	2.0	82		09.90	07.91 + ABS		BAR26105		280 26,0 23,0 V
	2.0	89		09.90	07.92 + ABS				
	2.3	85		09.90	07.92 + ABS				
	2.3	111		09.90	07.92 + ABS				
	2.4 TD	80		09.90	07.92 + ABS				
	2.0	76		09.88	08.90 + Starrachse <sup>1)</sup>		BAR10189		281 9,6 8,4
	2.0	82		08.89	08.90 + Starrachse <sup>1)</sup>				
	2.0	82		09.90	07.91				
	2.0	86		08.87	08.88 + Starrachse <sup>1)</sup>				
	2.0	89		08.87	08.90 + Starrachse <sup>1)</sup>				
	2.0	89		09.90	07.92				
	2.3	83		08.87	12.89 + Starrachse <sup>1)</sup>				
	2.3	84		08.87	07.90 + Starrachse <sup>1)</sup>				
	2.3	85		08.87	08.90 + Starrachse <sup>1)</sup>				
	2.3	85		09.90	07.92				
	2.3	96		08.87	07.88 + Starrachse <sup>1)</sup>				
	2.3	100		08.89	07.90 + Starrachse <sup>1)</sup>				
	2.3	111		07.89	08.90 + Starrachse <sup>1)</sup>				
	2.3	111		09.90	07.92				
	2.3	114		08.88	07.90 + Starrachse <sup>1)</sup>				
	2.3	117		08.87	07.89 + Starrachse <sup>1)</sup>				
	2.3 T	115		08.87	07.89 + Starrachse <sup>1)</sup>				
	2.3 T	121		08.89	07.90 + Starrachse <sup>1)</sup>				
	2.3 T	134		08.87	07.88 + Starrachse <sup>1)</sup>				
	2.3 T	140		08.89	07.90 + Starrachse <sup>1)</sup>				
	2.4 D	60		08.87	07.88 + Starrachse <sup>1)</sup>				
	2.4 TD	80		08.87	08.90 + Starrachse <sup>1)</sup>				
	2.4 TD	80		09.90	07.92				
	2.4 TD Intercooler	90		08.87	07.88 + Starrachse <sup>1)</sup>				
<b>Classic PKW VOLVO 740 Limousine (83-92)</b>									
	2.0	89		09.90	07.92 + ABS		BA2181		20164 18,2 LUC
	2.3	85		09.90	07.92 + ABS				
	2.3	111		09.90	07.92 + ABS				
	2.3	114		09.90	07.91 + ABS				
	2.4 D	60		09.90	07.92 + ABS				
	2.0	89		09.90	07.92 + ABS		BAR26105		280 26,0 23,0 V
	2.3	85		09.90	07.92 + ABS				
	2.3	111		09.90	07.92 + ABS				
	2.3	114		09.90	07.91 + ABS				
	2.4 D	60		09.90	07.92 + ABS				
	2.0	76		09.88	08.90 + Starrachse <sup>1)</sup>		BAR10189		281 9,6 8,4
	2.0	86		01.87	08.88 + Starrachse <sup>1)</sup>				
	2.0	89		08.85	08.90 + Starrachse <sup>1)</sup>				
	2.0	89		09.90	07.92				
	2.0	110		12.83	07.84				
	2.0	118		01.86	08.90 + Starrachse <sup>1)</sup>				
	2.0	120		01.85	12.85				
	2.3	82		08.84	07.86				
	2.3	83		09.85	12.89 + Starrachse <sup>1)</sup>				
	2.3	84		08.84	07.90 + Starrachse <sup>1)</sup>				
	2.3	85		08.87	08.90 + Starrachse <sup>1)</sup>				
	2.3	85		09.90	07.92				
	2.3	86		08.86	07.88 + Starrachse <sup>1)</sup>				
	2.3	95		08.83	07.84				
	2.3	96		08.84	07.88 + Starrachse <sup>1)</sup>				
	2.3	100		08.88	07.90 + Starrachse <sup>1)</sup>				
	2.3	111		08.88	08.90 + Starrachse <sup>1)</sup>				
	2.3	111		09.90	07.92				
	2.3	114		08.88	08.90 + Starrachse <sup>1)</sup>				
	2.3	114		09.90	07.91				
	2.3	117		08.87	07.89 + Starrachse <sup>1)</sup>				
	2.3 T	115		08.86	07.89 + Starrachse <sup>1)</sup>				
	2.3 T	121		08.89	07.90 + Starrachse <sup>1)</sup>				







<sup>1)</sup> + rigid axle / + assale rigido / + essieu rigide / + eje rígido

								
<b>Classic PKW VOLVO 740 Limousine (83-92)</b>								
	2.3 T	134	08.85	12.88	+ Starrachse <sup>1)</sup>	BAR10189		281 9,6 8,4
	2.3 T	140	08.89	07.90	+ Starrachse <sup>1)</sup>			
	2.4 D	60	08.84	08.90	+ Starrachse <sup>1)</sup>			
	2.4 D	60	09.90	07.92				
	2.4 TD	80	08.85	07.87	+ Starrachse <sup>1)</sup>			
	2.4 TD	83	08.84	07.90	+ Starrachse <sup>1)</sup>			
	2.4 TD	90	08.86	10.88	+ Starrachse <sup>1)</sup>			
<b>Classic PKW VOLVO 760 Kombi (82-92)</b>								
	2.3	84	08.84	08.87		BAR10189		281 9,6 8,4
	2.3 T	134	08.84	08.87				
	2.4 D	60	01.82	08.87				
	2.8	95	05.86	08.87				
	2.8	105	05.86	08.87				
	2.8	115	08.86	08.87				
<b>Classic PKW VOLVO 760 Limousine (82-92)</b>								
	2.3 T	127	08.82	07.84		BAR10189		281 9,6 8,4
	2.3 T	134	08.84	08.87				
	2.4 D	60	01.82	08.87				
	2.4 TD	80	04.87	08.87				
	2.4 TD	82	08.82	07.87				
	2.8	95	01.82	08.87				
	2.8	105	05.86	08.87				
	2.8	108	08.86	08.87				
	2.8	115	08.81	08.87				
<b>DACIA DUSTER (HS_) (10-)</b>								
	1.5 dCi	63	04.10		- ABS	BA2284		23973 17,3 /S LUC
	1.5 dCi	66	10.10		- ABS			
	1.5 dCi	79	06.10		- ABS			
	1.6 16V	77	04.10					
	1.6 16V 4x4	77	06.10					
	1.6 16V LPG	77	04.11					
<b>DACIA LOGAN Express (FS_) (09-)</b>								
	1.2 i 16V	55	06.09			BA2023		21463 18,0 /WK/S LUC
	1.4	55	03.09			BA2284		23973 17,3 /S LUC
	1.5 dCi	50	03.09					
	1.5 dCi	55	05.10					
	1.5 dCi	63	03.09					
	1.5 dCi	65	05.10					
	1.6	64	03.09					
	1.6 Bifuel	62	05.10					
	1.6 MPI 85	62	05.10					
	1.2 i 16V	55	06.09		- ABS	BAR12116	- belüftete Scheiben <sup>2)</sup>	238 12,0 10,5
	1.2 i 16V	55	06.09		+ ABS	BAR12171	- belüftete Scheiben <sup>2)</sup>	259 12,0 10,6
	1.2 i 16V	55	06.09			BAR21106	+ belüftete Scheiben <sup>3)</sup>	259 20,6 17,7 V
	1.2 i 16V	55	06.09		- ABS	BAW1907		Rz 19,05 BDX
	1.2 i 16V	55	06.09		+ ABS	BAW1707		Rz 17,78 BOS
	1.2 i 16V	55	06.09		+ ABS	BAW1704		Rz 17,78 LUC
	1.2 i 16V	55	06.09		+ ABS	BAE5002		203 x 38 HEB LUC
<b>DACIA LOGAN Limousine (LS_) (04-)</b>								
	1.2 16V	55	02.06			BA2023		21463 18,0 /WK/S LUC
	1.4	55	09.04					
	1.4 MPI LPG	55	02.06					
	1.5 dCi	48	09.05					
	1.5 dCi	50	01.06					
	1.5 dCi	55	05.10					
	1.5 dCi	63	09.07					
	1.5 dCi	65	05.10					
	1.6 16V	64	09.04					
	1.6 16V	77	02.06					
	1.6 Bifuel	62	05.10					
	1.6 MPI 85	62	05.10					
	1.2 16V	55	02.06		- ABS	BAR12116	- belüftete Scheiben <sup>2)</sup>	238 12,0 10,5
	1.4	55	09.04		- ABS			
	1.4 MPI LPG	55	02.06		- ABS			
	1.5 dCi	48	09.05		- ABS			
	1.5 dCi	50	01.06		- ABS			
	1.5 dCi	55	05.10		- ABS			
	1.5 dCi	63	09.07		- ABS			
	1.5 dCi	65	05.10		- ABS			
	1.6 16V	64	09.04		- ABS			
	1.6 16V	77	02.06		- ABS			
	1.6 Bifuel	62	05.10		- ABS			
	1.6 MPI 85	62	05.10		- ABS			
	1.2 16V	55	02.06		+ ABS	BAR12171	- belüftete Scheiben <sup>2)</sup>	259 12,0 10,6
	1.4	55	09.04		+ ABS			
	1.4 MPI LPG	55	02.06		+ ABS			
	1.5 dCi	48	09.05		+ ABS			
	1.5 dCi	50	01.06		+ ABS			

<sup>1)</sup> + rigid axle / + assale rigido / + essieu rigide / + eje rígido























<sup>2)</sup> - ventilated discs / - dischi ventilati / - disques ventilés / - disco ventilado

<sup>3)</sup> + ventilated discs / + dischi ventilati / + disques ventilés / + disco ventilado

											
DACIA LOGAN Limousine (LS_) (04-)											
	1.5 dCi	55		05.10	+ ABS	BAR12171		- belüftete Scheiben <sup>1)</sup>	259 12,0 10,6		
	1.5 dCi	63		09.07	+ ABS						
	1.5 dCi	65		05.10	+ ABS						
	1.6 16V	64		09.04	+ ABS						
	1.6 16V	77		02.06	+ ABS						
	1.6 Bifuel	62		05.10	+ ABS						
	1.6 MPI 85	62		05.10	+ ABS						
	1.2 16V	55		02.06		BAR21106		+ belüftete Scheiben <sup>2)</sup>	259 20,6 17,7 V		
	1.4	55		09.04							
	1.4 MPI LPG	55		02.06							
	1.5 dCi	48		09.05							
	1.5 dCi	50		01.06							
	1.5 dCi	55		05.10							
	1.5 dCi	63		09.07							
	1.5 dCi	65		05.10							
	1.6 16V	64		09.04							
	1.6 16V	77		02.06							
	1.6 Bifuel	62		05.10							
	1.6 MPI 85	62		05.10							
	1.2 16V	55		02.06	- ABS	BAW1907			Rz 19,05	BDX	
	1.4	55		09.04	- ABS						
	1.4 MPI LPG	55		02.06	- ABS						
	1.5 dCi	48		09.05	- ABS						
	1.5 dCi	50		01.06	- ABS						
	1.5 dCi	55		05.10	- ABS						
	1.5 dCi	63		09.07	- ABS						
	1.5 dCi	65		05.10	- ABS						
	1.6 16V	64		09.04	- ABS						
	1.6 16V	77		02.06	- ABS						
	1.6 Bifuel	62		05.10	- ABS						
	1.6 MPI 85	62		05.10	- ABS						
	1.2 16V	55		02.06	+ ABS	BAW1707			Rz 17,78	BOS	
	1.4	55		09.04	+ ABS						
	1.4 MPI LPG	55		02.06	+ ABS						
	1.5 dCi	48		09.05	+ ABS						
	1.5 dCi	50		01.06	+ ABS						
	1.5 dCi	55		05.10	+ ABS						
	1.5 dCi	63		09.07	+ ABS						
1.5 dCi	65		05.10	+ ABS							
1.6 16V	64		09.04	+ ABS							
1.6 16V	77		02.06	+ ABS							
1.6 Bifuel	62		05.10	+ ABS							
1.6 MPI 85	62		05.10	+ ABS							
	1.2 16V	55		02.06	+ ABS	BAW1704			Rz 17,78	LUC	
	1.4	55		09.04	+ ABS						
	1.4 MPI LPG	55		02.06	+ ABS						
	1.5 dCi	48		09.05	+ ABS						
	1.5 dCi	50		01.06	+ ABS						
	1.5 dCi	63		09.07	+ ABS						
	1.5 dCi	65		05.10	+ ABS						
	1.6 16V	64		09.04	+ ABS						
	1.6 16V	77		02.06	+ ABS						
	1.6 Bifuel	62		05.10	+ ABS						
	1.6 MPI 85	62		05.10	+ ABS						
		1.2 16V	55		02.06		+ ABS	BAE5002			
		1.4	55		09.04	+ ABS					
		1.4 MPI LPG	55		02.06	+ ABS					
		1.5 dCi	48		09.05	+ ABS					
		1.5 dCi	50		01.06	+ ABS					
		1.5 dCi	63		09.07	+ ABS					
		1.5 dCi	65		05.10	+ ABS					
		1.6 16V	64		12.08	+ ABS					
1.6 16V		77		12.08	+ ABS						
1.6 Bifuel		62		05.10	+ ABS						
1.6 MPI 85		62		05.10	+ ABS						
DACIA LOGAN MCV Kombi (KS_) (07-)											
	1.4	55		02.07		BA2023		- ABS	21463 18,0 /WK/S	LUC	
	1.5 dCi	50		02.07							
	1.5 dCi	55		05.10							
	1.5 dCi	63		09.07							
	1.5 dCi	65		05.10							
	1.6	64		02.07							
	1.4	55		02.07		BA2335		+ ABS	24673 18,0 +	ATE	
	1.5 dCi	50		02.07	11.08						
	1.5 dCi	63		09.07	11.08						
	1.6	64		02.07							
	1.6 16V	77		02.07	11.08						
	1.6 Bifuel	64		11.08							
	1.6 MPI 85	62		05.10							
	1.5 dCi	50		12.08		BA2284		+ ABS	23973 17,3 /S	LUC	
	1.5 dCi	55		05.10							
1.5 dCi	63		12.08								
1.5 dCi	65		05.10								
1.6 16V	77		12.08								
1.6 16V Flexifuel	77		11.09								





























<sup>1)</sup> - ventilated discs / - dischi ventilati / - disques ventilés / - disco ventilado



























<sup>2)</sup> + ventilated discs / + dischi ventilati / + disques ventilés / + disco ventilado

								
<b>DACIA LOGAN MCV Kombi (KS_) (07-)</b>								
	1.5 dCi	50	02.07	- ABS	BAR21106			259 20,6 17,7 V
	1.5 dCi	55	05.10	- ABS				
	1.5 dCi	63	09.07	- ABS				
	1.5 dCi	65	05.10	- ABS				
<b>DACIA LOGAN Pick-up (US_) (08-)</b>								
	1.5 dCi	50	03.08	11.08	BA2335			24673 18,0 + ATE
	1.5 dCi	63	03.08	11.08				
	1.6	64	03.08	11.08				
	1.4	55	01.09		BA2284			23973 17,3 /S LUC
	1.5 dCi	50	12.08					
	1.5 dCi	55	05.10					
	1.5 dCi	63	12.08					
	1.5 dCi	65	05.10					
	1.6	64	12.08					
	1.6 Bifuel	62	05.10					
	1.6 MPI 85	62	05.10					
<b>DACIA SANDERO (08-)</b>								
	1.2 16V	55	11.08		BA2023			21463 18,0 /WK/S LUC
	1.2 16V Bifuel	55	11.08					
	1.4	55	06.08					
	1.4 MPI LPG	53	01.09					
	1.5 dCi	50	11.08					
	1.5 dCi	55	05.10					
	1.5 dCi	65	05.10					
	1.6	64	06.08					
	1.6 MPI 85	62	05.10					
	1.5 dCi	63	11.08		BA2335		+ belüftete Scheiben <sup>1)</sup>	24673 18,0 + ATE
	1.2 16V	55	11.08		BAR12171		- belüftete Scheiben <sup>2)</sup>	259 12,0 10,6
	1.2 16V Bifuel	55	11.08					
	1.4	55	06.08					
	1.4 MPI LPG	53	01.09					
	1.5 dCi	50	11.08					
	1.5 dCi	55	05.10					
	1.5 dCi	65	05.10					
	1.6	64	06.08					
	1.6 MPI 85	62	05.10					
	1.2 16V	55	02.09		BAR21106		+ belüftete Scheiben <sup>1)</sup>	259 20,6 17,7 V
	1.2 16V Bifuel	55	11.08					
	1.5 dCi	55	05.10					
	1.5 dCi	65	05.10					
	1.6 MPI 85	62	05.10					
	1.2 16V	55	11.08		BAW1707			Rz 17,78 BOS
	1.2 16V Bifuel	55	11.08					
	1.4	55	06.08					
	1.4 MPI LPG	53	01.09					
	1.5 dCi	50	11.08					
	1.5 dCi	55	05.10					
	1.5 dCi	65	05.10					
	1.6	64	06.08					
	1.6 MPI 85	62	05.10					
<b>DAEWOO ARANOS (95-97)</b>								
	1.5	66	01.95	11.97	BA2137			21190 17,5 +/WE ATE
	1.8	70	01.95	11.97				
	2.0	77	01.95	11.97				
	1.5	66	01.95	11.97	BAR24115			256 24,0 21,0 V L
	1.8	70	01.95	11.97				
	2.0	77	01.95	11.97				
	1.5	66	01.95	11.97	BAW1904			Rz 19,05 LUC
	1.8	70	01.95	11.97				
	2.0	77	01.95	11.97				
	1.5	66	01.95	11.97	BAE5011			200 x 46 HEB
	1.8	70	01.95	11.97				
	2.0	77	01.95	11.97				
<b>DAEWOO CIELO (94-98)</b>								
	1.5	66	06.94	07.98	BA2137			21190 17,5 +/WE ATE
	1.5	66	06.94	07.98	BAR24115			256 24,0 21,0 V L
	1.5	66	06.94	07.98	BAE5011			200 x 46 HEB
<b>DAEWOO ESPERO (95-99)</b>								
	1.5 i 16V		02.95	06.99	BA2137			21190 17,5 +/WE ATE
	1.8 i		02.95	06.99				
	2.0 i		02.95	06.99				

























<sup>1)</sup> + ventilated discs / + dischi ventilati / + disques ventilés / + disco ventilado

<sup>2)</sup> - ventilated discs / - dischi ventilati / - disques ventilés / - disco ventilado







								
<b>DAEWOO ESPERO (95-99)</b>								
	1.5 i 16V 1.8 i 2.0 i			02.95 02.95 02.95	06.99 06.99 06.99		BAR24115	256 24,0 21,0 V L
	1.5 i 16V 1.8 i 2.0 i			02.95 02.95 02.95	06.99 06.99 06.99		BAW1904	Rz 19,05 LUC
	1.5 i 16V 1.8 i 2.0 i			02.95 02.95 02.95	06.99 06.99 06.99		BAE5011	200 x 46 HEB
<b>DAEWOO KALOS (02-05)</b>								
	1.2 i 1.4 i 1.4 i 16V 1.6 i 16V	53 61 69 78		04.03 09.02 04.03 11.02	02.05 02.05 02.05 02.05		BAR20115	236 20,0 17,0 V L
<b>DAEWOO LANOS (97-02)</b>								
	1.4 i 1.5 i	55 63	447433 447433	05.97 05.97			BA2136	20547 16,8 +/WE ATE
	1.4 i 1.5 i	55 63	447434 447434		12.02 12.02		BA2123	23241 15,8
	1.6 i 16V 1.6 i 16V	78 78	447433 447434	05.97 12.02			BA2137 BA2122	21190 17,5 +/WE ATE 23234 16,8 AKE
	1.4 i 1.5 i 1.6 i 16V	55 63 78		05.97 05.97 05.97	12.02 12.02 12.02		BAR20115 BAR24115	236 20,0 17,0 V L 256 24,0 21,0 V L
	1.4 i 1.5 i	55 63	447433 447433	05.97 05.97			BAW1705	Rz 17,46 LUC
	1.4 i 1.5 i 1.6 i 16V	55 63 78	447434 447434 447433		12.02 12.02 05.97		BAW1904	Rz 19,05 LUC
	1.4 i 1.5 i 1.6 i 16V	55 63 78		05.97 05.97 05.97	12.02 12.02 12.02		BAE5011	200 x 46 HEB
<b>DAEWOO MATIZ (98-05)</b>								
	0.8 (KLA4) 1.0 (KLA0)	38 47		07.98 01.03	02.05 02.05		BA2123	23241 15,8
<b>DAEWOO NEXIA (95-97)</b>								
	1.5 i 1.5 i 16V 1.8 i			02.95 02.95 10.95	08.97 08.97 08.97		BA2136 BA2137	20547 16,8 +/WE ATE 21190 17,5 +/WE ATE
	1.5 i 1.5 i 16V 1.8 i			02.95 02.95 10.95	08.97 08.97 08.97		BAR20115 BAR24115	236 20,0 17,0 V L 256 24,0 21,0 V L
	1.5 i 1.5 i 16V 1.8 i	66 66 74		02.95 02.95 10.95	08.97 08.97 08.97		BAW1705 BAW1904	Rz 17,46 LUC Rz 19,05 LUC
	1.5 i 1.5 i 16V 1.8 i	66 66 74		02.95 02.95 10.95	08.97 08.97 08.97		BAE5011	200 x 46 HEB
<b>DAEWOO NUBIRA (97-99)</b>								
	1.6 i 16V 1.8 i 16V 2.0 i 16V	78 70 98		06.97 04.97 06.97	05.99 05.99 05.99		BA2122	23234 16,8 AKE
	1.6 i 16V 1.8 i 16V	78 70		06.97 04.97	05.99 05.99	- ABS	BAE5011	200 x 46 HEB
<b>DAEWOO NUBIRA (99-05)</b>								
	1.6 i 16V 1.6 i 16V	76 78		07.00 06.99	02.05 02.05	- ABS - ABS	BAE5011	200 x 46 HEB
<b>FIAT 500 (07-)</b>								
	1.2 i 1.2 i Start-Stop 1.2 LPG 1.4 i 16V	51 51 51 74		07.07 11.08 12.10 07.07			BA2302 BA2283	21436 17,0 /WK BOS 23706 17,8 +/WK/S BOS
	0.9 1.4 i 16V 1.4 Abarth 1.4 Abarth	63 74 99 118		07.10 07.07 07.08 08.08			BAR12127 BAR22197 BAR22147	257 12,0 10,2 258 22,0 20,2 V 284 22,0 20,2 V
	1.4 i 16V 1.4 Abarth 1.4 Abarth	74 99 118		07.07 07.08 08.08			BAR11119 BAR11119	240 11,0 9,2 240 11,0 9,2

								
<b>FIAT 500 (07-)</b>								
	1.2 i 1.2 i Start-Stop 1.3 D Multijet 1.3 D Multijet	51 51 55 70		07.07 11.08 07.07 12.09	05.10 05.10 05.10 05.10	BAW2009		Rz 20,64 <b>BDX</b>
<b>FIAT 500C Cabrio (09-)</b>								
	1.2 1.4	51 74		09.09 09.09		BA2302 BA2283		21436 17,0 /WK 23706 17,8 +/WK/S <b>BOS</b>
	0.9 1.4 1.4 Abarth	63 74 103		09.09 09.09 09.09		BAR12127 BAR22197 BAR22147		257 12,0 10,2 258 22,0 20,2 V 284 22,0 20,2 V
	1.4 1.4 Abarth	74 103		09.09 09.09		BAR11119 BAR11119	- Kit ESSEESSE - Kit ESSEESSE	240 11,0 9,2 240 11,0 9,2
	0.9 1.2 1.3 D Multijet 1.3 D Multijet	63 51 55 70		09.09 09.09 09.09 09.09	05.10 05.10 05.10 05.10	BAW2009		Rz 20,64 <b>BDX</b>
<b>FIAT BARCHETTA (95-04)</b>								
	1.8 i 16V 1.8 i 16V			04.95 06.95	05.95 10.04	BA2034 BA2143		20833 17,1 +/WK/S 21927 17,9 +/WK <b>LUC</b> <b>ATE</b>
	1.8 i 16V			04.95	10.04	BAR20142		258 20,0 18,2 V L
	1.8 i 16V			04.95	10.04	BA2035	+ GG-Sättel <sup>1)</sup>	21103 14,4 /S <b>LUC</b>
	1.8 i 16V			04.95	10.04	BAR11119		240 11,0 9,2
<b>FIAT BRAVA (95-01)</b>								
	1.2 i 16V 1.4 i 12V 1.6 16 V 1.6 i 16V 1.9 D 1.9 TD			12.98 09.95 01.99 09.95 09.95 06.96	10.01 + Schaltgetriebe <sup>2)</sup> 10.01 + Schaltgetriebe <sup>2)</sup> 12.02 + Schaltgetriebe <sup>2)</sup> 10.01 + Schaltgetriebe <sup>2)</sup> 10.01 + Schaltgetriebe <sup>2)</sup> 10.01 + Schaltgetriebe <sup>2)</sup>	BA2142		21930 17,9 +/WK <b>ATE</b>
	1.8 i 16V 1.9 JTD 1.9 TD 2.0	76 74 113		09.95 12.98 06.96 09.98	10.01 10.01 10.01 08.00	BA2143		21927 17,9 +/WK <b>ATE</b>
	1.2 i 16V 1.4 i 12V 1.6 16 V 1.6 i 16V 1.9 D 1.9 TD			12.98 09.95 01.99 09.95 09.95 06.96	10.01 + Schaltgetriebe <sup>2)</sup> 10.01 + Schaltgetriebe <sup>2)</sup> 12.02 + Schaltgetriebe <sup>2)</sup> 10.01 + Schaltgetriebe <sup>2)</sup> 10.01 + Schaltgetriebe <sup>2)</sup> 10.01 + Schaltgetriebe <sup>2)</sup>	BAR12127		257 12,0 10,2
	1.2 i 16V 1.4 i 12V 1.6 16 V 1.6 i 16V 1.8 i 16V 1.9 D 1.9 JTD 1.9 TD 2.0	76 76 55		12.98 09.95 01.99 09.95 09.95 06.96 09.98	10.01 + Automatikgetriebe <sup>3)</sup> 10.01 + Automatikgetriebe <sup>3)</sup> 12.02 + Automatikgetriebe <sup>3)</sup> 10.01 + Automatikgetriebe <sup>3)</sup> 10.01 + Automatikgetriebe <sup>3)</sup> 10.01 + Automatikgetriebe <sup>3)</sup> 10.01 + Automatikgetriebe <sup>3)</sup> 10.01 + Automatikgetriebe <sup>3)</sup> 08.00	BAR20142		258 20,0 18,2 V L
	1.2 i 16V 1.4 i 12V 1.9 D			12.98 09.95 09.95	10.01 - ABS 10.01 - ABS 10.01 - ABS	BAE5016		180 x 32 HEB AUT <b>AP</b>
	1.2 i 16V 1.4 i 12V 1.6 16 V 1.6 i 16V 1.8 i 16V 1.9 D 1.9 JTD 1.9 TD	76		12.98 12.98 01.99 12.98 12.98 12.98 12.98	10.01 + ABS 10.01 + ABS 12.02 10.01 10.01 10.01 + ABS 10.01 10.01	BAE5038		203 x 38 HEB <b>AP</b>
<b>FIAT BRAVO (95-01)</b>								
	1.2 i 16V 1.4 i 12V 1.6 i 16V 1.9 D 1.9 TD			12.98 09.95 09.95 09.95 06.96	10.01 10.01 10.01 10.01 10.01	BA2142		21930 17,9 +/WK <b>ATE</b>
	1.8 i 16V 1.9 JTD 1.9 TD	74		09.95 12.98 06.96	10.01 10.01 10.01	BA2143		21927 17,9 +/WK <b>ATE</b>
	2.0 i 20V			05.99	10.01	BA2315		23289 19,3 +/WK <b>ATE</b>

<sup>1)</sup> + cast iron caliper / + pinza in ghisa / + étriers en fonte grise / + fundición gris-pinza  
<sup>2)</sup> + manual transmission / + scatola cambio velocità / + transmission mécanique / + cambio de velocidad  
<sup>3)</sup> + autom.transmission / + scatola cambio automatico / + transmission automatique / + cambio automático

										
<b>FIAT BRAVO (95-01)</b>										
	1.2 i 16V		12.98	10.01	BAR12127			257 12,0 10,2		
	1.4 i 12V		09.95	10.01						
	1.6 i 16V		09.95	10.01						
	1.9 D		09.95	10.01						
	1.9 TD	55	06.96	10.01						
	1.8 i 16V		09.95	10.01	BAR20142			258 20,0 18,2 V L		
	1.9 JTD		12.98	10.01						
	1.9 TD	74	06.96	10.01						
	2.0 i 20V		09.95	10.01	BAR22147			284 22,0 20,2 V		
	2.0 i 20V		09.95	10.01	BA2035		+ GG-Sättel <sup>1)</sup>	21103 14,4 /S LUC		
	2.0 i 20V		09.95	10.01	BAR11119			240 11,0 9,2		
	1.2 i 16V		12.98	10.01	BAE5016			180 x 32 HEB AUT AP		
	1.4 i 12V		09.95	10.01						
	1.9 D		09.95	10.01						
	1.2 i 16V		12.98	10.01	BAE5038			203 x 38 HEB AP		
	1.4 i 12V		12.98	10.01						
	1.6 i 16V		12.98	10.01						
	1.8 i 16V		12.98	10.01						
	1.9 D		12.98	10.01						
	1.9 JTD		12.98	10.01						
	1.9 TD		12.98	10.01						
				10.01						
			10.01							
<b>FIAT BRAVO (07-)</b>										
	1.4 16V	103	04.08		BA2299			23709 19,4 +/WK/S BOS		
	1.4 T-Jet	88	09.07							
	1.6 D Multijet		03.08							
	1.9 D Multijet		04.07							
	1.9 D Multijet	66	04.07	12.08						
	1.4 i 16V	66	04.07		BAR22197			258 22,0 20,2 V		
	1.4 LPG	66	11.09							
	1.4 16V	103	04.08			BAR22147				284 22,0 20,2 V
	1.4 T-Jet	88	09.07							
	1.6 D Multijet		03.08							
1.9 D Multijet		04.07								
	1.9 D Multijet	66	04.07	12.08						
	1.4 16V	103	04.08		BA2303			23714 16,3 /S BOS		
	1.4 i 16V	66	04.07							
	1.4 LPG	66	11.09							
	1.4 T-Jet	88	09.07							
	1.4 T-Jet	110	09.07							
	1.6 D Multijet		03.08							
	1.9 D Multijet		04.07							
	1.9 D Multijet	66	04.07	12.08						
	1.9 D Multijet	110	04.07							
	2.0 D Multijet		09.08							
<b>FIAT CINQUECENTO (92-98)</b>										
	1100 Sporting		11.94	05.98	BA2071			21365 17,0 BDX		
	700		02.92	05.98						
	900 i.e.		02.92	05.98						
	1100 Sporting		11.94	05.98	BAR11119			240 11,0 9,2		
	700		02.92	05.98						
	900 i.e.		02.92	05.98						
	1100 Sporting		11.94	05.98	BAW1902			Rz 19,05		
	700		02.92	05.98						
	900 i.e.		02.92	05.98						
<b>FIAT COUPE (94-00)</b>										
	2.0 i 16V Turbo		12.93	06.96	BAR22147			284 22,0 20,2 V		
	1.8 i 16V		47167	07.96	BA2035		+ GG-Sättel <sup>1)</sup>	21103 14,4 /S LUC		
	2.0 i 16V			12.93						
	2.0 i 16V Turbo			12.93						
	2.0 i 20V		47167	01.97						
	2.0 i 20V Turbo		47167	01.97						
	1.8 i 16V		07.96	12.00	BAR11119			240 11,0 9,2		
	2.0 i 16V		12.93	06.96						
	2.0 i 16V Turbo		12.93	06.96						
	2.0 i 20V		01.97	12.00						
	2.0 i 20V Turbo		01.97	12.00						
<b>FIAT CROMA (91-96)</b>										
	2.5 i.e. V6		04.93	10.96	BAR22147			284 22,0 20,2 V		

<sup>1)</sup> + cast iron caliper / + pinza in ghisa / + étriers en fonte grise / + fundición gris-pinza

FIAT CROMA (05-10)													
	1.8 i 16V	103		01.06	02.06	BA2236	für Bremssattel m. Kunststoffkolben <sup>2)</sup>	23402 20,4 +/WE	ATE				
	1.9 D Multijet	85		06.05	02.06								
	1.9 JTD	88		06.05	02.06								
	2.2 i 16V	108		06.05	02.06								
	1.8 i 16V	103		03.06	11.10								
	1.9 D Multijet	85		03.06	11.10								
1.9 JTD	88		03.06	11.10									
1.9 JTD 16V	2060169			11.10									
2.2 i 16V	108		03.06	11.10									
	1.8 i 16V	103		01.06	11.10	BAR25141		285 24,9 22,0 V L					
	1.9 D Multijet	85		06.05	11.10								
	1.9 JTD	88		06.05	11.10								
	1.9 JTD 16V	2060168		06.05	11.10								
	2.2 i 16V	108		06.05	11.10								
	1.8 i 16V	103		01.06	11.10	BAR12157		278 12,0 10,0					
	1.9 D Multijet	85		06.05	11.10								
	1.9 JTD	88		06.05	11.10								
	1.9 JTD 16V	2060168		06.05	11.10								
	2.2 i 16V	108		06.05	11.10								
FIAT DOBLO (01-10)													
	1.2 i.e.	48		01.01	09.05	BA2334		23842 18,0 +	ATE				
	1.3 JTD	51		05.04	09.05								
	1.6 i 16V	76		10.01	09.05								
	1.6 Natural Power	76		09.02	12.04								
	1.9 D	46		01.01	09.05								
	1.9 JTD	74		10.01	09.05								
	1.9 JTD	77		07.03	09.05								
	1.3 16V	66		12.09	01.10					BA2289		23708 18,4 /S	BOS
	1.3 D Multijet	55		10.05	01.10								
	1.3 D Multijet	62		10.05	01.10								
	1.3 JTD	55		10.05	01.10								
	1.3 JTD	62		10.05	01.10								
1.4 16V	70		12.09	01.10									
1.4 i	57		10.05	01.10									
1.9 D Multijet	88		10.05	01.10									
1.9 JTD	77		10.05	01.10									
1.9 JTD	88		10.05	01.10									
2.0 16V	99		12.09	01.10									
	1.2 i.e.	48		01.01	09.05	BAR20142		258 20,0 18,2 V L					
	1.3 JTD	51		05.04	09.05								
	1.6 i 16V	76		10.01	09.05								
	1.6 Natural Power	76		09.02	12.04								
	1.9 D	46		01.01	09.05								
	1.9 JTD	74		10.01	09.05								
	1.9 JTD	77		07.03	09.05								
	1.3 16V	66		12.09	01.10					BAR22147		284 22,0 20,2 V	
	1.3 D Multijet	55		10.05	01.10								
	1.3 D Multijet	62		10.05	01.10								
	1.3 JTD	55		10.05	01.10								
	1.3 JTD	62		10.05	01.10								
1.4 16V	70		12.09	01.10									
1.4 i	57		10.05	01.10									
1.9 JTD	74		10.05	01.10									
1.9 JTD	77		10.05	01.10									
1.9 JTD	88		10.05	01.10									
1.9 JTD	88		10.05	01.10									
2.0 16V	99		12.09	01.10									
1.3 D Multijet	55		10.05	01.10	BAR22197		258 22,0 20,2 V						
1.3 JTD	55		10.05	01.10									
1.6 16V	77		12.09	01.10									
1.6 i 16V	76		10.05	01.10									
1.6 Natural Power	76		01.05	01.10									
FIAT DUCATO (94-02)													
	1.9 D (10)			02.94	12.99	BA2045		21797 19,7 +/WK/S	LUC				
	1.9 TD (10)			02.94	12.99								
	1.9 TD-ECO (10)			02.94	12.99								
	2.0 i (10/14)			02.94	12.99								
	2.5 D (14)			02.94	12.99								
	2.5 TDI (14)			02.94	12.99								
	2.5 TDI ECO (14)			02.94	12.99								
	2.8 D (14)			02.98	12.99								
	2.8 TDI (14)			10.97	12.99								
	1.9 D (10)			01.00	10.01					BA2325		23602 19,7 +/WK/S	LUC
	1.9 TD (10)			01.00	10.01								
	1.9 TD-ECO (10)			01.00	10.01								
	2.0 i (10/14)			01.00	10.01								
	2.5 D (14)			01.00	10.01								
2.5 TDI (14)			01.00	10.01									
2.5 TDI ECO (14)			01.00	10.01									
2.8 D (14)			01.00	10.01									
2.8 JTD (14)			11.00	10.01									
2.8 TDI (14)			01.00	10.01	BA2241		23917 19,0 +/WK/Zub	BRE					
1.9 D (10)			11.01	03.02									
1.9 TD (10)			11.01	03.02									
1.9 TD-ECO (10)			11.01	03.02									

<sup>1)</sup> + reinforced suspension / + sospensione rinforzata / + châssis renforcé / + suspensión reforzada









<sup>2)</sup> + for br.caliper +plastic piston / per pinza fr. +pistone plastica / pour étrier fr. +piston plastique / para pinza fr. + pistón plástico

<sup>3)</sup> + for br.caliper +plastic piston / per pinza fr. +pistone plastica / pour étrier fr. +piston plastique / para pinza fr. + pistón plastic



**FIAT DUCATO (94-02)**

	2.0 i (10/14)		11.01	03.02	BA2241		23917 19,0 +/WK/Zub	BRE				
	2.0 JTD (14)		10.01	03.02								
	2.5 D (14)		11.01	03.02								
	2.5 TDI (14)		11.01	03.02								
	2.5 TDI ECO (14)		11.01	03.02								
	2.8 D (14)		11.01	03.02								
	2.8 JTD (14)		11.01	03.02								
	2.8 TDI (14)		11.01	03.02								
	2.0 i (18)		02.94	12.99					BA2046		21799 19,7 +/WK/S	LUC
	2.5 D (18)		02.94	12.99								
	2.5 TDI (18)		02.94	12.99								
	2.5 TDI ECO (18)		02.94	12.99								
2.8 D (18)		02.98	12.99									
2.8 TDI (18)		10.97	12.99	BA2324		23919 18,3 +/WK/Zub	BRE					
2.0 i (18)		11.01	03.02									
2.0 JTD (18)		10.01	03.02									
2.5 D (18)		11.01	03.02									
2.5 TDI (18)		11.01	03.02									
2.5 TDI ECO (18)		11.01	03.02									
2.8 D (18)		11.01	03.02									
2.8 JTD (18)		11.01	03.02									
2.8 TDI (18)		11.01	03.02									
	1.9 D (10)		02.94	10.01	BAR18108		280 18,0 15,9					
	1.9 TD (10)		02.94	10.01								
	1.9 TD-ECO (10)		02.94	10.01								
	2.0 i (10/14)		02.94	10.01								
	2.5 D (14)		02.94	10.01								
	2.8 D (14)		02.98	10.01	BAR24127		280 24,0 21,9 V					
	2.5 TDI (14)		02.94	10.01								
	2.5 TDI ECO (14)		02.94	10.01								
	2.8 JTD (14)		11.00	10.01								
	2.8 TDI (14)		10.97	10.01	BAR24138		300 24,0 21,9 V					
	2.0 i (18)		02.94	10.01								
	2.5 D (18)		02.94	10.01								
	2.5 TDI (18)		02.94	10.01								
	2.5 TDI ECO (18)		02.94	10.01								
	2.8 D (18)		02.98	10.01								
	2.8 JTD (18)		11.00	10.01	BAR24127		280 24,0 21,9 V					
	2.8 TDI (18)		10.97	10.01								
	1.9 D (10)		11.01	03.02								
	1.9 TD (10)		11.01	03.02								
	1.9 TD-ECO (10)		11.01	03.02								
2.0 i (10/14)		11.01	03.02									
2.0 JTD (14)		10.01	03.02									
2.5 D (14)		11.01	03.02									
2.5 TDI (14)		11.01	03.02									
2.5 TDI ECO (14)		11.01	03.02									
2.8 D (14)		11.01	03.02	BAR24138		300 24,0 21,9 V						
2.8 JTD (14)		11.01	03.02									
2.8 TDI (14)		11.01	03.02									
2.0 i (18)		11.01	03.02									
2.0 JTD (18)		10.01	03.02									
2.5 D (18)		11.01	03.02									
2.5 TDI (18)		11.01	03.02	BA2323		23921 20,0 /Zub	BRE					
2.5 TDI ECO (18)		11.01	03.02									
2.8 D (18)		11.01	03.02									
2.8 JTD (18)		11.01	03.02									
2.8 TDI (18)		11.01	03.02									
1.9 D (10)		11.01	03.02									
1.9 TD (10)		11.01	03.02									
1.9 TD-ECO (10)		11.01	03.02									
2.0 i (10/14/18)		11.01	03.02									
2.0 JTD (14/18)		10.01	03.02									
2.5 D (14/18)		11.01	03.02									
2.5 TDI (14/18)		11.01	03.02									
2.5 TDI ECO (14/18)		11.01	03.02									
2.8 D (14/18)		11.01	03.02									
2.8 JTD (14/18)		11.01	03.02									
2.8 TDI (14/18)		11.01	03.02									
	2.5 TDI (14)		02.94	10.01	BAW2600		Rz 26,99					
	2.5 TDI ECO (14)		02.94	10.01								
	2.8 D (14)		02.98	10.01								
	2.8 JTD (14)		11.00	10.01								
	2.8 TDI (14)		10.97	10.01					BAW2800		Rz 28,57	
	2.0 i (18)		02.94	10.01								
	2.5 D (18)		02.94	10.01								
	2.5 TDI (18)		02.94	10.01								
	2.5 TDI ECO (18)		02.94	10.01								
	2.8 D (18)		02.98	10.01								
	2.8 JTD (18)		11.00	10.01								
	2.8 TDI (18)		10.97	10.01	BAW2600		Rz 26,99					
	1.9 D (10)		11.01	03.02								
1.9 TD (10)		11.01	03.02									
1.9 TD-ECO (10)		11.01	03.02									
2.0 i (10/14)		11.01	03.02									
2.0 JTD (14)		10.01	03.02									

FIAT DUCATO (94-02)													
	2.5 D (14) 2.5 TDI (14) 2.5 TDI ECO (14) 2.8 D (14) 2.8 JTD (14) 2.8 TDI (14)			11.01 11.01 11.01 11.01 11.01 11.01	03.02 03.02 03.02 03.02 03.02 03.02			BAW2600				Rz 26,99	
	1.9 D (10) 1.9 TD (10) 1.9 TD-ECO (10) 2.0 i (10/14) 2.5 D (14) 2.5 TDI (14) 2.5 TDI ECO (14) 2.8 D (14) 2.8 JTD (14) 2.8 TDI (14)			02.94 02.94 02.94 02.94 02.94 02.94 02.94 02.98 11.00 10.97	10.01 10.01 10.01 10.01 10.01 10.01 10.01 10.01 10.01 10.01			BAE5023				254 x 57 HEB	LUC
	2.0 i (18) 2.5 D (18) 2.5 TDI (18) 2.5 TDI ECO (18) 2.8 D (18) 2.8 JTD (18) 2.8 TDI (18)			02.94 02.94 02.94 02.94 02.98 11.00 10.97	10.01 10.01 10.01 10.01 10.01 10.01 10.01			BAE5042				254 x 57 HEB	LUC
	1.9 D (10) 1.9 TD (10) 1.9 TD-ECO (10) 2.0 i (10/14) 2.0 JTD (14) 2.5 D (14) 2.5 TDI (14) 2.5 TDI ECO (14) 2.8 D (14) 2.8 JTD (14) 2.8 TDI (14)			11.01 11.01 11.01 11.01 10.01 11.01 11.01 11.01 11.01 11.01 11.01	03.02 03.02 03.02 03.02 03.02 03.02 03.02 03.02 03.02 03.02 03.02			BAE5032		- Quick Fit		254 x 57 HEB	AP
FIAT DUCATO (02-06)													
	2.0 i (11/15) 2.0 JTD (11/15) 2.3 JTD (11/15) 2.8 JTD (11/15) 2.8 JTD 4x4 (11/15)	81 62 81 81 94		04.02 04.02 04.02 04.02 07.02	07.06 07.06 07.06 07.06 07.06			BA2241				23917 19,0 +/WK/Zub	BRE
	2.0 i (18) 2.0 JTD (18) 2.3 JTD (18) 2.8 JTD (18) 2.8 JTD 4x4 (18)	81 62 81 81 94		04.02 04.02 04.02 04.02 07.02	07.06 07.06 07.06 07.06 07.06			BA2324				23919 18,3 +/WK/Zub	BRE
	2.0 i (11/15) 2.0 JTD (11/15) 2.3 JTD (11/15) 2.8 JTD (11/15) 2.8 JTD 4x4 (11/15)	81 62 81 81 94		04.02 04.02 04.02 04.02 07.02	07.06 07.06 07.06 07.06 07.06			BAR24127				280 24,0 21,9 V	
	2.0 i (18) 2.0 JTD (18) 2.3 JTD (18) 2.8 JTD (18) 2.8 JTD 4x4 (18)	81 62 81 81 94		04.02 04.02 04.02 04.02 07.02	07.06 07.06 07.06 07.06 07.06			BAR24138				300 24,0 21,9 V	
	2.0 i (11/15/18) 2.0 JTD (11/15/18) 2.3 JTD (11/15/18) 2.8 JTD (11/15/18) 2.8 JTD 4x4(11/15/18)	81 62 81 81 94		04.02 04.02 04.02 04.02 07.02	07.06 07.06 07.06 07.06 07.06			BA2323				23921 20,0 /Zub	BRE
	2.0 i (11/15) 2.0 JTD (11/15) 2.3 JTD (11/15) 2.8 JTD (11/15) 2.8 JTD 4x4 (11/15)	81 62 81 81 94		04.02 04.02 04.02 04.02 07.02	07.06 07.06 07.06 07.06 07.06			BAW2600				Rz 26,99	
	2.0 i (11/15) 2.0 JTD (11/15) 2.3 JTD (11/15) 2.8 JTD (11/15) 2.8 JTD 4x4 (11/15)	81 62 81 81 94		04.02 04.02 04.02 04.02 07.02	07.06 07.06 07.06 07.06 07.06			BAE5032		- Quick Fit		254 x 57 HEB	AP
FIAT DUCATO (06-)													
	140 Natural Power 2.0 D 115 Multijet 2.2 D 100 Multijet 2.3 D 120 Multijet 2.3 D 130 Multijet 2.3 D 150 Multijet 3.0 D 150 Multijet 3.0 D 160 Multijet 3.0 D Multijet	100 85 74 88 96 109 107 116 130		04.09 06.11 07.06 07.06 01.07 06.11 04.10 07.06 06.11	Nutzlast 110/150 Nutzlast 110/150 Nutzlast 110/150 Nutzlast 110/150 Nutzlast 110/150 Nutzlast 110/150 Nutzlast 110/150 Nutzlast 110/150 Nutzlast 110/150			BA2275				24468 18,5 +/WK/Zub	BRE
	140 Natural Power 2.0 D 115 Multijet 2.2 D 100 Multijet 2.3 D 120 Multijet	100 85 74 88		04.09 06.11 07.06 07.06	Nutzlast leicht 170 Nutzlast leicht 170 Nutzlast leicht 170 Nutzlast leicht 170			BA2275				24468 18,5 +/WK/Zub	BRE

<sup>1)</sup> payload 110/150 / carico utile 110/150 / charge utile 110/150 / carga útil 110/150

<sup>2)</sup> light payload 170 / carico utile leggero 170 / charge utile légère 170 / carga útil ligera 170

<sup>3)</sup> heavy payload 170 / carico utile pesante 170 / charge utile lourde 170 / carga útil pesada 170

<b>FIAT DUCATO (06-)</b>																	
	2.3 D 130 Multijet	96			<b>01.07</b>	Nutzlast leicht 17Q		<b>BA2275</b>									<b>24468</b> 18,5 +/WK/Zub <b>BRE</b>
	2.3 D 150 Multijet	109			<b>06.11</b>	Nutzlast leicht 17Q											
	3.0 D 150 Multijet	107			<b>04.10</b>	Nutzlast leicht 17Q											
	3.0 D 160 Multijet	116			<b>07.06</b>	Nutzlast leicht 17Q											
	3.0 D Multijet	130			<b>06.11</b>	Nutzlast leicht 17Q											
	140 Natural Power	100			<b>04.09</b>	Nutzlast schwer 17Q		<b>BA2328</b>									<b>24466</b> 19,1 +/WK/Zub <b>BRE</b>
	2.0 D 115 Multijet	85			<b>06.11</b>	Nutzlast schwer 17Q											
	2.2 D 100 Multijet	74			<b>07.06</b>	Nutzlast schwer 17Q											
	2.3 D 120 Multijet	88			<b>07.06</b>	Nutzlast schwer 17Q											
	2.3 D 130 Multijet	96			<b>01.07</b>	Nutzlast schwer 17Q											
	2.3 D 150 Multijet	109			<b>06.11</b>	Nutzlast schwer 17Q											
	3.0 D 150 Multijet	107			<b>04.10</b>	Nutzlast schwer 17Q											
	3.0 D 160 Multijet	116			<b>07.06</b>	Nutzlast schwer 17Q											
	3.0 D Multijet	130			<b>06.11</b>	Nutzlast schwer 17Q											
		140 Natural Power	100			<b>04.09</b>	Nutzlast 110/15Q		<b>BAR24127</b>								
2.0 D 115 Multijet		85			<b>06.11</b>	Nutzlast 110/15Q											
2.2 D 100 Multijet		74			<b>07.06</b>	Nutzlast 110/15Q											
2.3 D 120 Multijet		88			<b>07.06</b>	Nutzlast 110/15Q											
2.3 D 130 Multijet		96			<b>01.07</b>	Nutzlast 110/15Q											
2.3 D 150 Multijet		109			<b>06.11</b>	Nutzlast 110/15Q											
3.0 D 150 Multijet		107			<b>04.10</b>	Nutzlast 110/15Q											
3.0 D 160 Multijet		116			<b>07.06</b>	Nutzlast 110/15Q											
3.0 D Multijet		130			<b>06.11</b>	Nutzlast 110/15Q											
		140 Natural Power	100			<b>04.09</b>	Nutzlast schwer 17Q		<b>BAR24138</b>								
	2.0 D 115 Multijet	85			<b>06.11</b>	Nutzlast schwer 17Q											
	2.2 D 100 Multijet	74			<b>07.06</b>	Nutzlast schwer 17Q											
	2.3 D 120 Multijet	88			<b>07.06</b>	Nutzlast schwer 17Q											
	2.3 D 130 Multijet	96			<b>01.07</b>	Nutzlast schwer 17Q											
	2.3 D 150 Multijet	109			<b>06.11</b>	Nutzlast schwer 17Q											
	3.0 D 150 Multijet	107			<b>04.10</b>	Nutzlast schwer 17Q											
	3.0 D 160 Multijet	116			<b>07.06</b>	Nutzlast schwer 17Q											
	3.0 D Multijet	130			<b>06.11</b>	Nutzlast schwer 17Q											
		140 Natural Power	100			<b>04.09</b>			<b>BA2265</b>								
2.0 D 115 Multijet		85			<b>06.11</b>												
2.2 D 100 Multijet		74			<b>07.06</b>												
2.3 D 120 Multijet		88			<b>07.06</b>												
2.3 D 130 Multijet		96			<b>01.07</b>												
2.3 D 150 Multijet		109			<b>06.11</b>												
3.0 D 150 Multijet		107			<b>04.10</b>												
3.0 D 160 Multijet		116			<b>07.06</b>												
3.0 D Multijet		130			<b>06.11</b>												
<b>FIAT FIORINO / FIORINO QUBO (08-)</b>																	
	1.3 D Multijet	55			<b>09.08</b>	- Halbautomatik Selespeed <sup>1)</sup>		<b>BA2283</b>									<b>23706</b> 17,8 +/WK/S <b>BOS</b>
	1.4	54			<b>09.08</b>												
	1.4 Natural Power	57			<b>10.09</b>												
	1.3 D Multijet	55			<b>09.08</b>			<b>BAR22197</b>									258 22,0 20,2 V
	1.3 MPI	52			<b>01.07</b>												
	1.4	54			<b>09.08</b>												
	1.4 Natural Power	57			<b>10.09</b>												
	1.3 D Multijet	70			<b>07.10</b>			<b>BAR22147</b>									284 22,0 20,2 V
<b>FIAT GRANDE PUNTO (06-11)</b>																	
	1.2 i				<b>10.05</b>	<b>01.11</b>		<b>BA2283</b>									<b>23706</b> 17,8 +/WK/S <b>BOS</b>
	1.3 JTD				<b>10.05</b>	<b>08.10</b>											
	1.4 bivalent CNG	51			<b>10.08</b>	<b>01.11</b>											
	1.4 i				<b>10.05</b>	<b>08.10</b>											
	1.4 i 16V				<b>10.05</b>	<b>01.11</b>											
	1.4 LPG	57			<b>12.08</b>	<b>01.11</b>											
	1.4 Natural Power	57			<b>07.08</b>	<b>01.11</b>											
	1.2 i				<b>10.06</b>	<b>01.11</b>		<b>BAR12184</b>									257 12,0 10,0
<b>FIAT IDEA (04-)</b>																	
	1.3 D Multijet	66			<b>11.05</b>	<b>02.08</b>		<b>BA2289</b>									<b>23708</b> 18,4 /S <b>BOS</b>
	1.3 D Multijet	70			<b>05.08</b>												
	1.3 JTD	51			<b>01.04</b>	<b>02.08</b>											
	1.6 D Multijet	88			<b>05.08</b>												
	1.9 JTD	74			<b>01.04</b>	<b>02.08</b>											
	1.2 i 16V	59			<b>01.04</b>	<b>02.08</b>		<b>BAR22197</b>									258 22,0 20,2 V
	1.4 i	57			<b>11.05</b>	<b>02.08</b>											
	1.4 i 16V	70			<b>01.04</b>	<b>02.08</b>											
	1.4 LPG	57			<b>03.09</b>												
	1.3 D Multijet	66			<b>11.05</b>	<b>02.08</b>		<b>BAR22147</b>									284 22,0 20,2 V
	1.3 D Multijet	70			<b>05.08</b>												
	1.3 JTD	51			<b>01.04</b>	<b>02.08</b>											
	1.6 D Multijet	88			<b>05.08</b>												
	1.9 JTD	74			<b>01.04</b>	<b>02.08</b>											
	1.6 D Multijet	88			<b>05.08</b>			<b>BAR11119</b>									240 11,0 9,2
	1.3 D Multijet	66			<b>11.05</b>	<b>05.08</b>		<b>BAW2003</b>									Rz 20,64 <b>AP</b>
	1.3 D Multijet	70				<b>05.08</b>											
	1.3 JTD	51			<b>01.04</b>	<b>05.08</b>											























<sup>1)</sup> - Selespeed semi-automatic transmission / - Cambio semiautomatico Selespeed / - Boîte semi-automatique

Selespeed / - Cambio semiautomático Selespeed





























<sup>2)</sup> payload 11Q/15Q / carico utile 11Q/15Q / charge utile 11Q/15Q / carga útil 11Q/15Q

<sup>3)</sup> light payload 17Q / carico utile leggero 17Q / charge utile légère 17Q / carga útil ligera 17Q

<sup>4)</sup> heavy payload 17Q / carico utile pesante 17Q / charge utile lourde 17Q / carga útil pesada 17Q























								
<b>FIAT IDEA (04-)</b>								
	1.9 JTD	74	01.04	06.05	BAW2003			Rz 20,64 AP
<b>FIAT LINEA (07-11)</b>								
	1.3 JTD 1.4 i	66	07.07 07.07	05.11 05.11	BA2283			23706 17,8 +/WK/S BOS
	1.3 JTD 1.4 i	66	07.07 07.07	05.11 05.11	BAR22197			258 22,0 20,2 V
	1.4 i 16V Turbo 1.6 JTD	77	07.07 01.09	05.11 05.11	BAR22147			284 22,0 20,2 V
	1.4 i 16V Turbo 1.6 JTD	77	07.07 01.09	05.11 05.11	BA2271			23517 16,3 /S LUC
<b>FIAT MAREA (96-02)</b>								
	1.2 i 16V Lim. 1.4 i 12V 1.6 i 16V Lim. 1.9 TD	55	04.99 09.96 09.96 09.96	12.02 12.02 12.02 12.02	BA2142			21930 17,9 +/WK ATE
	1.2 i 16V Kombi 1.6 i 16V Kombi 1.8 i 16V 1.9 JTD 1.9 TD	74	04.99 09.96 09.96 04.99 09.96	12.02 12.02 12.02 12.02 12.02	BA2143			21927 17,9 +/WK ATE
	2.0 i 20V 2.4 JTD		05.99 04.99	12.02 12.02	BA2315			23289 19,3 +/WK ATE
	1.2 i 16V Lim. 1.4 i 12V 1.6 i 16V Lim. 1.9 TD	55	04.99 09.96 09.96 09.96	12.02 12.02 12.02 12.02	BAR12127			257 12,0 10,2
	1.2 i 16V Kombi 1.6 i 16V Kombi 1.8 i 16V 1.9 JTD 1.9 TD	74	04.99 09.96 09.96 04.99 09.96	12.02 12.02 12.02 12.02 12.02	BAR20142			258 20,0 18,2 V L
	2.0 i 20V 2.4 JTD 2.4 TD		09.96 04.99 09.96	12.02 12.02 04.99	BAR22147			284 22,0 20,2 V
	2.0 i 20V 2.4 JTD 2.4 TD		09.96 04.99 09.96	12.02 12.02 04.99	BA2035	+ GG-Sättel <sup>1)</sup>		21103 14,4 /S LUC
	2.0 i 20V 2.4 JTD 2.4 TD		09.96 04.99 09.96	12.02 12.02 04.99	BAR11119			240 11,0 9,2
	1.6 i 16V Kombi 1.8 i 16V Kombi 1.9 JTD Kombi 1.9 TD Kombi		09.96 09.96 04.99 09.96	12.02 12.02 12.02 12.02	BAW2008			Rz 20,64
	1.2 i 16V 1.4 i 12V 1.6 i 16V Lim. 1.8 i 16V Lim. 1.9 JTD Lim. 1.9 TD Lim.		04.99 04.97 04.97 04.97 04.99 04.97	12.02 12.02 12.02 12.02 12.02 12.02	BAE5038			203 x 38 HEB AP
	1.6 i 16V Kombi 1.8 i 16V Kombi 1.9 JTD Kombi 1.9 TD Kombi		04.97 04.97 04.99 04.97	12.02 12.02 12.02 12.02	BAE5029			228 x 43 HEB
<b>FIAT MULTIPLA (98-08)</b>								
	1.6 1.6 16V 1.6 16V Bipower 1.9 JTD		09.00 02.99 04.99 02.99	02.01 09.04 03.02 09.04	BA2315			23289 19,3 +/WK ATE
	1.6 1.6 16V 1.9 JTD		09.00 04.02 04.02	02.01 11.05 11.05	BA2303			23714 16,3 /S BOS
	1.6 16V 1.6 16V Bluepower 1.9 JTD		12.05 04.99 12.05	02.08 02.08 02.08	BA2303			23714 16,3 /S BOS
	1.6 1.6 16V 1.6 16V Bipower 1.6 16V Bluepower 1.9 JTD		09.00 02.99 04.99 04.99 02.99	02.01 02.08 03.02 02.08 02.08	BAW2008			Rz 20,64
	1.6 1.6 16V 1.6 16V Bipower 1.6 16V Bluepower 1.9 JTD		09.00 02.99 04.99 04.99 02.99	02.01 02.08 03.02 02.08 02.08	BAE5029			228 x 43 HEB

<sup>1)</sup> + cast iron caliper / + pinza in ghisa / + étriers en fonte grise / + fundición gris-pinza

								
<b>FIAT PALIO / PALIO WEEKEND EUROPA (97-06)</b>								
	1.2 (75) 1.6 i 16V (100) 1.7 TD (70) 1.9 D		12.98 10.97 12.98 03.01	12.06 12.06 12.06 12.06	BAR20142			258 20,0 18,2 V L
	1.2 (75) 1.6 i 16V (100) 1.7 TD (70) 1.9 D		10.97 10.97 10.97 03.01	12.06 12.06 12.06 12.06	BAW2008			Rz 20,64
	1.2 (75) 1.6 i 16V (100) 1.7 TD (70) 1.9 D		10.97 10.97 10.97 03.01	12.06 12.06 12.06 12.06	BAE5029			228 x 43 HEB
<b>FIAT PANDA (86-02)</b>								
	1000 1000 i.e. 1100 4x4 750 900		01.86 10.87 02.91 01.86 01.86 04.92	12.92 12.02 12.02 12.02 12.97 12.96	BA2064			20775 18,0 /WE BDX
	1000 1000 i.e. 1100 4x4 750 900		01.86 10.87 02.91 01.86 01.86 04.92	12.92 12.02 12.02 12.02 12.97 12.96	BAW1902			Rz 19,05
<b>FIAT PANDA (03-)</b>								
	1.1 i 1.2 1.2 i	40 51 44	09.03 03.10 09.03		BA2072			21436 17,0 BDX
	1.3 D Multijet 4x4 1.4	74	10.04 11.06		BA2283			23706 17,8 +/WK/S BOS
	1.1 i 1.2 1.2 i	40 51 44	09.03 03.10 09.03		BAR11119			240 11,0 9,2
	1.3 D Multijet 4x4 1.4	74	10.04 11.06		BAR22197			258 22,0 20,2 V
	1.2 4x4 1.2 i 4x4 1.3 D Multijet 4x4 1.4	51 44 74	10.10 10.04 10.04 11.06		BAR11119			240 11,0 9,2
	1.1 i 1.2 1.2 Bi-Power 1.2 i 1.3 D Multijet 1.3 JTD 1.3 JTD 1.4 Bi-/Natural Power	40 51 44 44 51 51 55	09.03 03.10 01.07 09.03 09.03 09.03 06.06 01.07		BAW2003		- ABS	Rz 20,64 AP
	1.1 i 1.2 1.2 Bi-Power 1.2 i 1.3 D Multijet 1.3 JTD 1.3 JTD 1.4 Bi-/Natural Power	40 51 44 44 51 51 55	09.03 03.10 01.07 09.03 09.03 09.03 06.06 01.07	05.10 05.10 05.10 05.10 05.10 05.10	BAW2009		+ ABS	Rz 20,64 BDX
<b>FIAT PANDA SUV (06-)</b>								
	1.3 JTD 4x4 Cross	51	04.06		BA2283			23706 17,8 +/WK/S BOS
	1.3 JTD 4x4 Cross	51	04.06		BAR22197			258 22,0 20,2 V
	1.3 JTD 4x4 Cross	51	04.06		BAR11119			240 11,0 9,2
<b>FIAT PANDA (12-)</b>								
	0.9 0.9 Twinair Turbo NP	63 59	02.12 02.12		BAR22197 BAR12127		für Leichtmetallfelgen Serie 2 <sup>2)</sup> für Leichtmetallfelgen Serie 3 <sup>2)</sup>	58 22,0 20,2 V 257 12,0 10,2
	0.9 1.2 1.2 EasyPower LPG 1.3 D Multijet II	48 51 51 55	02.12 02.12 02.12 02.12		BAR12127			257 12,0 10,2 258 22,0 20,2 V
<b>FIAT PUNTO (93-00)</b>								
	1.1 i (55) 1.2 i (60) Cabrio 1.2 i (60/75) Lim. 1.7 D		11.93 03.94 11.93 01.95	09.99 06.00 09.99 05.97	BA2072 BA2073			21436 17,0 BDX 21436 17,0 /WK BDX
	1.1 i (55) 1.2 i (60) Cabrio		11.93 03.94	09.99 06.00	BA2034			20833 17,1 +/WK/S LUC

1) + manual transmission / + scatola cambio velocità / + transmission mécanique / + cambio de velocidad

2) for light alloy rims / per cerchione in lega / pour jantes en alliage léger / para Llantas de aleación

									
<b>FIAT PUNTO (93-00)</b>									
	1.2 i (60/75) Lim.		11.93	09.99	BA2034		20833 17,1 +/WK/S	LUC	
	1.4 GT		11.93	05.97					
	1.6 i (90) Cabrio		03.94	05.97					
	1.6 i (90) Lim.		03.94	05.97					
	1.7 TD		11.93	05.97					
	1.2 i 16V (85) Cabrio		06.97	06.00	BA2332		23181 17,9 +	ATE	
	1.2 i 16V (85) Lim.		06.97	09.99					
	1.4 GT		06.97	09.99	BA2143		21927 17,9 +/WK	ATE	
	1.1 i (55)		11.93	05.97	BAR11119		240 11,0 9,2		
	1.1 i (55)		06.97	09.99					
	1.2 i (60) Cabrio		03.94	05.97					
	1.2 i (60) Cabrio		06.97	06.00					
	1.2 i (60/75) Lim.		11.93	05.97					
	1.2 i (60/75) Lim.		06.97	09.99					
	1.7 D		01.95	05.97					
	1.1 i (55)		11.93	05.97	BAR12127		257 12,0 10,2		
	1.2 i (60) Cabrio		03.94	05.97					
	1.2 i (60/75) Lim.		11.93	05.97					
	1.2 i 16V (85) Cabrio		06.97	06.00					
	1.2 i 16V (85) Lim.		06.97	09.99					
	1.6 i (90) Cabrio		03.94	05.97					
	1.6 i (90) Lim.		03.94	05.97					
	1.7 TD		11.93	09.99					
	1.4 GT		11.93	09.99	BAR20142		258 20,0 18,2 V L		
	1.4 GT		11.93	05.97	BA2035	+ GG-Sättel <sup>1)</sup>	21103 14,4 /S	LUC	
	1.4 GT		11.93	09.99	BAR11119		240 11,0 9,2		
		1.1 i (55)		11.93	09.99	BAW2009		Rz 20,64	BDX
		1.2 i (60) Cabrio		03.94	06.00	BAW2003		Rz 20,64	AP
1.2 i (60/75) Lim.			11.93	09.99					
1.2 i 16V (85) Cabrio			06.97	06.00					
1.2 i 16V (85) Lim.			06.97	09.99					
1.6 i (90) Cabrio			03.94	05.97					
1.6 i (90) Lim.			03.94	05.97					
1.7 D			01.95	05.97					
1.7 TD			11.93	09.99					
		1.1 i (55)		11.93	09.99	BAE5016		180 x 32 HEB AUT	AP
	1.2 i (60) Cabrio		03.94	06.00					
	1.2 i (60/75) Lim.		11.93	09.99					
	1.2 i 16V (85) Cabrio		06.97	06.00					
	1.2 i 16V (85) Lim.		06.97	09.99					
	1.6 i (90) Cabrio		03.94	05.97					
	1.6 i (90) Lim.		03.94	05.97					
	1.7 D		01.95	05.97					
	1.7 TD		11.93	09.99					
	<b>FIAT PUNTO (00-03)</b>								
	1.2 i		10.99	06.03	BA2072 BA2073		21436 17,0	BDX	
	1.2 i 16V		10.99	06.03	+ Schaltgetriebe <sup>2)</sup>	BA2332	21436 17,0 /WK	BDX	
	1.2 i		10.99	06.03	BAR11119		23181 17,9 +	ATE	
	1.2 i 16V		10.99	06.03	BAR12127		240 11,0 9,2		
	1.9 D		10.99	06.03			257 12,0 10,2		
	1.8 i 16V		10.99	06.03	BAR22197		258 22,0 20,2 V		
	1.9 JTD		10.99	06.03	BAR20142		258 20,0 18,2 V L		
	1.8 i 16V		10.99	06.03	BAR11119		240 11,0 9,2		
	1.2 i		10.99	06.03	+ ABS	BAE5010	180 x 32 HEB	AP	
	1.2 i 16V		10.99	06.03	+ ABS/ + Schaltgetriebe <sup>3)</sup>				
	1.2 i 16V		10.99	06.03	+ Automatikgetriebe <sup>4)</sup>				
	1.9 D		10.99	06.03					
	1.9 JTD		10.99	06.03					
<b>FIAT PUNTO (03-06)</b>									
	1.2 i		07.03	11.05	BA2072		21436 17,0	BDX	
	1.2 i 16V		07.03	11.05	BA2332		23181 17,9 +	ATE	
	1.8 i 16V		07.03	11.05	BA2315		23289 19,3 +/WK	ATE	
	1.9 JTD	74	07.03	11.05					
	1.2 i		07.03	11.05	BAR12127		257 12,0 10,2		
	1.2 i 16V		07.03	11.05					
	1.3 JTD 16V		07.03	11.05	BAR20142		258 20,0 18,2 V L		
	1.4 i 16V		07.03	11.05					
	1.9 JTD	63	07.03	11.05					
	1.8 i 16V		07.03	11.05	BAR11119		240 11,0 9,2		
	1.9 JTD	74	07.03	11.05					





















<sup>1)</sup> + cast iron caliper / + pinza in ghisa / + étriers en fonte grise / + fundición gris-pinza

<sup>2)</sup> + manual transmission / + scatola cambio velocità / + transmission mécanique / + cambio de velocidad

<sup>3)</sup> + ABS/ + manual transm. / + ABS/+ scatola camb.velocità / + ABS/ + transmission mécanique / + ABS/ + cambio de velocidad

<sup>4)</sup> + autom.transmission / + scatola cambio automatico / + transmission automatique / + cambio automático

<b>FIAT PUNTO (03-06)</b>																		
	1.2 i 1.2 i 16V 1.3 JTD 16V 1.9 JTD			07.03 07.03 07.03 07.03	11.05 + ABS 11.05 + ABS 11.05 11.05			BAE5010									180 x 32 HEB	AP
<b>FIAT SCUDO (95-06)</b>																		
	1.6 i.e. 1.9 D 1.9 TD 2.0 i 16V 2.0 JTD			11.95 11.95 11.95 06.00 12.99	12.06 12.06 12.06 12.06 12.06			BA2079									23042 18,7 /WK	BDX
	1.6 i.e. 1.9 D 1.9 TD 2.0 i 16V 2.0 JTD			11.95 11.95 11.95 06.00 12.99	09.03 09.03 09.03 09.03 09.03			BA2047									21801 19,0 +/WK/S	LUC
	1.6 i.e. 1.9 D 1.9 TD 2.0 i 16V 2.0 JTD			10.03 10.03 10.03 10.03 10.03	12.06 12.06 12.06 12.06 12.06			BA2285									20261 19,3 +/WK/S	LUC
	1.6 i.e. 1.9 D 1.9 TD 2.0 i 16V 2.0 JTD			11.95 11.95 11.95 06.00 12.99	12.06 12.06 12.06 12.06 12.06			BAR20155									258 20,0 18,2 V L	
	1.6 i.e. 1.9 D 1.9 TD 2.0 i 16V 2.0 JTD			11.95 11.95 11.95 06.00 12.99	09.03 09.03 09.03 09.03 09.03			BAR26104									281 26,0 24,2 V	
	1.6 i.e. 1.9 D 1.9 TD 2.0 i 16V 2.0 JTD			10.03 10.03 10.03 10.03 10.03	12.06 12.06 12.06 12.06 12.06			BAR28136									285 28,0 26,0 V	
	1.6 i.e. 1.9 D 1.9 TD 2.0 i 16V 2.0 JTD			11.95 11.95 11.95 06.00 12.99	12.06 12.06 12.06 12.06 12.06			BAW1906									Rz 19,05	
	1.6 i.e. 1.9 D 1.9 TD 2.0 i 16V 2.0 JTD			11.95 11.95 11.95 06.00 12.99	12.06 12.06 12.06 12.06 12.06			BAE5037									255 x 61	
<b>FIAT SCUDO (07-)</b>																		
	1.6 JTD 2.0 D Multijet 2.0 D Multijet 2.0 D Multijet 2.0 JTD	66 88 94 120		01.07 01.07 04.11 07.10 01.07				BA2329									24595 18,9 +/WK/S	LUC
	1.6 JTD 2.0 D Multijet 2.0 D Multijet 2.0 D Multijet 2.0 JTD	66 88 94 120		01.07 01.07 04.11 07.10 01.07				BA2330									24578 16,3 /S	LUC
	1.6 JTD 2.0 D Multijet	66 120		01.07 07.10				BAE5042									254 x 57 HEB	LUC
<b>FIAT SEICENTO (98-08)</b>																		
	1100 i.e. 900 i.e.			04.98 04.98	03.08 03.08			BA2072									21436 17,0	BDX
	1100 i.e. 900 i.e.			04.98 04.98	03.08 03.08			BAR11119									240 11,0 9,2	
	1100 i.e. 900 i.e.			04.98 04.98	03.08 03.08			BAW1902									Rz 19,05	
<b>FIAT STILO / STILO Multi Wagon (01-08)</b>																		
	1.8 16V 1.9 D Multijet 1.9 JTD 1.9 JTD			10.01 09.05 02.02 10.01	03.08 03.08 03.08 03.08			BA2299									23709 19,4 +/WK/S	BOS
	1.2 i 16V 1.4 i 16V 1.6 16V	59		02.02 01.04 10.01	03.08 03.08 03.08			BAR22197									258 22,0 20,2 V	
	1.8 16V 1.9 D Multijet 1.9 JTD 1.9 JTD			10.01 09.05 02.02 10.01	03.08 03.08 03.08 03.08			BAR22147									284 22,0 20,2 V	





















	   kW							
<b>FIAT STILO / STILO Multi Wagon (01-08)</b>								
	1.2 i 16V	59	02.02	05.05	BA2303			23714 16,3 / S BOS
	1.4 i 16V		01.04	05.05				
	1.6 16V		10.01	05.05				
	1.6 16V	100	04.05	05.05				
	1.8 16V		10.01	05.05				
	1.9 JTD		02.02	05.05				
	1.9 JTD		10.01	05.05				
	1.9 JTD		01.04	05.05				
	2.4 20V		10.01	05.05				
	1.2 i 16V	59	06.05	03.08				
1.4 i 16V		06.05	03.08					
1.6 16V		06.05	03.08					
1.6 16V	100	06.05	03.08					
1.8 16V		06.05	03.08					
1.9 D Multijet		09.05	03.08					
1.9 D Multijet	110	09.05	03.08					
1.9 JTD		06.05	03.08					
1.9 JTD		06.05	03.08					
1.9 JTD		06.05	03.08					
2.4 20V		06.05	03.08					
<b>FIAT STRADA / PICK-UP (99-)</b>								
	1.2		05.99		BAR20142			258 20,0 18,2 V L
	1.3 JTD	62	05.06					
	1.7 TD	51	05.99					
	1.9 D	46	12.00					
	1.9 JTD	59	04.03					
<b>FIAT STRADA II (11-)</b>								
	1.3 D Multijet	62	01.11		BAR20142			258 20,0 18,2 V L
<b>FIAT TALENTO (88-94)</b>								
	1.9 D		10.88	12.94	BA2024			20741 19,2 +WK/S LUC
	2.0		07.90	12.94				
	1.9 D		10.88	12.94	BAR16105			256 16,1 13,5
	2.0		07.90	12.94				
<b>FIAT TEMPRA (93-96)</b>								
	1.4 i.e.		05.93	09.96	BA2034			20833 17,1 +WK/S LUC
	1.6 i.e.		05.93	09.96				
	1.8 i.e.		05.93	09.96				
	1.9 D		05.93	09.96				
	1.9 TD		05.93	09.96				
	2.0 i.e.		05.93	09.96				
	1.4 i.e. Lim.		05.93	09.96 - ABS	BAR11119			240 11,0 9,2
	1.6 i.e. Lim.		05.93	09.96 - ABS/ + Schaltgetriebe 1)				
	1.9 D Lim.		05.93	09.96 - ABS				
	1.4 i.e. Kombi		05.93	09.96	BAR12127			257 12,0 10,2
	1.4 i.e. Lim.		05.93	09.96 + ABS				
	1.6 i.e. Kombi		05.93	09.96				
	1.6 i.e. Lim.		05.93	09.96 + ABS/ + Automatikgetriebe 2)				
	1.8 i.e. Lim.		05.93	09.96				
	1.9 D Kombi		05.93	09.96				
1.9 D Lim.		05.93	09.96 + ABS	BAR20142			258 20,0 18,2 V L	
1.9 TD Lim.		05.93	09.96					
1.8 i.e. Kombi		05.93	09.96					
1.9 TD Kombi		05.93	09.96					
2.0 i.e.		05.93	09.96					
	1.4 i.e.		05.93	09.96 + ABS	BA2035			21103 14,4 / S LUC
	1.6 i.e.		05.93	09.96 + ABS				
	1.8 i.e.		05.93	09.96 + ABS				
	1.9 D		05.93	09.96 + ABS				
	1.9 TD		05.93	09.96 + ABS				
	2.0 i.e.		05.93	09.96				
	1.4 i.e.		05.93	09.96 + ABS	BAR11119			240 11,0 9,2
	1.6 i.e.		05.93	09.96 + ABS				
	1.8 i.e.		05.93	09.96 + ABS				
	1.9 D		05.93	09.96 + ABS				
	1.9 TD		05.93	09.96 + ABS				
	2.0 i.e.		05.93	09.96				
	1.6 i.e.		05.93	09.96 - ABS/ + Automatikgetriebe 3)	BAW2008			Rz 20,64
	1.8 i.e.		05.93	09.96 - ABS				
	1.9 TD		05.93	09.96 - ABS				
<b>FIAT TIPO (93-95)</b>								
	1.4 i.e.		05.93	09.95	BA2034			20833 17,1 +WK/S LUC
	1.6 i.e.		05.93	09.95				
	1.7 D		05.93	09.95				
	1.8 i.e.		05.93	09.95				
	1.9 D		05.93	09.95				
	1.9 TD		05.93	09.95				
	2.0 i.e.	83	05.93	09.95				

1) - ABS/ + manual transmission / - ABS/+ scatola camb.velocità / - ABS/ + transmission mécanique / - ABS/ + cambio de velocidad

























2) + ABS/ + autom.transmission / + ABS/ + scatola cambio autom. / + ABS/ + transmission automatique / + ABS/ + cambio automático

3) - ABS/ + autom.transmission / - ABS/ + scatola cambio autom. / - ABS/ + transmission automatique / - ABS/ + cambio automático



												
<b>FIAT TIPO (93-95)</b>												
	1.4 i.e.		05.93	09.95	- ABS	BAR11119		240 11,0 9,2				
	1.6 i.e.		05.93	09.95	- ABS							
	1.7 D		05.93	09.95								
	1.4 i.e.		05.93	09.95	+ ABS	BAR12127		257 12,0 10,2				
	1.6 i.e.		05.93	09.95	+ ABS							
	1.8 i.e.		05.93	09.95								
	1.9 TD		05.93	09.95								
	2.0 i.e.	83	05.93	09.95								
	2.0 i.e. 16V		05.93	09.95								
	1.4 i.e.		05.93	09.95	+ ABS	BAR20142		258 20,0 18,2 V L				
	1.6 i.e.		05.93	09.95	+ ABS							
	1.7 D		05.93	09.95	+ ABS							
	1.8 i.e.		05.93	09.95	+ ABS							
	1.9 D		05.93	09.95	+ ABS							
	1.9 TD		05.93	09.95	+ ABS							
	2.0 i.e.	83	05.93	09.95								
	2.0 i.e. 16V		05.93	09.95								
		1.6 i.e.		05.93	09.95				- ABS/ + Automatikgetriebe <sup>1)</sup>	BAW2008		Rz 20,64
		1.8 i.e.		05.93	09.95				- ABS			
1.9 TD			05.93	09.95	- ABS							
<b>FIAT ULYSSE (94-02)</b>												
	1.8 i.e.		06.96	07.02		BA2079		23042 18,7 /WK				
	1.9 TD		01.95	07.02								
	2.0 i.e.		06.94	07.02								
	2.0 i.e. Turbo		06.94	07.02								
	2.0 JTD		10.99	07.02								
	2.1 TD		06.96	10.99								
	1.8 i.e.		06.96	07.02		BAR20155		258 20,0 18,2 V L				
	1.9 TD		01.95	07.02								
	2.0 i.e.		06.94	07.02								
	2.0 i.e. Turbo		06.94	07.02								
	2.0 JTD		10.99	07.02								
	2.1 TD		06.96	10.99								
	1.8 i.e.		06.96	07.02	- ABS	BAW1906		Rz 19,05				
	1.9 TD		01.95	07.02	- ABS							
	2.0 i.e.		06.94	07.02	- ABS							
	2.0 JTD		10.99	07.02	- ABS							
	2.1 TD		06.96	10.99	- ABS							
	1.8 i.e.		06.96	07.02	- ABS	BAE5037		255 x 61				
	1.9 TD		01.95	07.02	- ABS							
	2.0 i.e.		06.94	07.02	- ABS							
	2.0 JTD		10.99	07.02	- ABS							
	2.1 TD		06.99	10.99	- ABS							
<b>FIAT ULYSSE (02-11)</b>												
	2.0 D Multijet	88	05.06	01.11		BA2285		20261 19,3 +/WK/S				
	2.0 D Multijet	100	05.06	01.11								
	2.0 i 16V	100	08.02	01.11								
	2.0 JTD	79	05.03	01.11								
	2.0 JTD	80	08.02	01.11								
	2.2 JTD	94	08.02	01.11								
	2.2 JTD	120	03.08	01.11								
	2.0 D Multijet	88	05.06	01.11		BAR28136		285 28,0 26,0 V				
	2.0 D Multijet	100	05.06	01.11								
	2.0 i 16V	100	08.02	01.11								
	2.0 JTD	79	05.03	01.11								
	2.0 JTD	80	08.02	01.11								
	2.2 JTD	94	08.02	01.11								
	2.2 JTD	120	03.08	01.11								
	2.0 D Multijet	88	05.06	01.11		BA2017		20961 17,2 /S				
	2.0 D Multijet	100	05.06	01.11								
	2.0 i 16V	100	08.02	01.11								
	2.0 JTD	79	05.03	01.11								
	2.0 JTD	80	08.02	01.11								
	2.2 D Multijet	125	03.08	01.11								
	2.2 JTD	94	08.02	01.11								
	2.2 JTD	120	03.08	01.11								
	3.0 i V6	150	08.02	01.11								
<b>FORD C-MAX (07-10)</b>												
	1.6 i 16V	74	03.07	10.10		BA2234		23723 18,4 +				
	1.6 TDCi		03.07	10.10								
	1.6 TDCi	66	03.07	10.10								
	1.8 i 16V		03.07	10.10								
	1.8 TDCi	85	03.07	10.10								
2.0 i 16V	107	03.07	10.10									

1) - ABS/ + autom.transmission / - ABS/ + scatola cambio autom. / - ABS/ + transmission automatique / - ABS/ + cambio automatico

								
<b>FORD C-MAX (07-10)</b>								
	2.0 TDCi 2.0 TDCi	81	03.07 02.08	10.10 10.10	BA2234			23723 18,4 + ATE
	1.8 TDCi 2.0 i 16V 2.0 TDCi 2.0 TDCi	85 107 81	03.07 03.07 03.07 02.08	10.10 10.10 10.10 10.10	BAR25162			300 25,0 23,0 V L
	1.6 i 16V 1.6 TDCi 1.6 TDCi 1.8 i 16V 1.8 TDCi 2.0 i 16V 2.0 TDCi 2.0 TDCi	74 66 85 107 81	03.07 03.07 03.07 03.07 03.07 03.07 03.07 02.08	10.10 10.10 10.10 10.10 10.10 10.10 10.10 10.10	BA2258			23482 16,4 + ATE
<b>FORD C-MAX / GRAND C-MAX (10-)</b>								
	1.6 EcoBoost 1.6 EcoBoost 1.6 TDCi 1.6 TDCi 1.6 Ti-VCT 1.6 Ti-VCT 1.6 Ti-VCT Flexifuel 2.0 TDCi 2.0 TDCi 2.0 TDCi	110 134 70 85 92 92 85 103 120	11.10 11.10 11.10 11.10 11.10 11.10 11.10 11.10 11.10 11.10		BA2234			23723 18,4 + ATE
	1.6 EcoBoost 1.6 EcoBoost 2.0 TDCi 2.0 TDCi 2.0 TDCi	110 134 85 103 120	11.10 11.10 11.10 11.10 11.10		BAR25162			300 25,0 23,0 V L
	1.6 EcoBoost 1.6 EcoBoost 1.6 TDCi 1.6 TDCi 1.6 Ti-VCT 1.6 Ti-VCT 1.6 Ti-VCT Flexifuel 2.0 TDCi 2.0 TDCi 2.0 TDCi	110 134 70 85 92 92 85 103 120	11.10 11.10 11.10 11.10 11.10 11.10 11.10 11.10 11.10 11.10		BA2258			23482 16,4 + ATE
<b>FORD COUGAR (98-00)</b>								
	2.0 i 16V 2.5 i V6		09.98 09.98	12.00 12.00	BA2139 BA2138			21394 18,0 + ATE 21396 18,0 +/WK ATE
	2.0 i 16V		09.98	12.00	BAR24120			260 24,0 22,2 V
	2.0 i 16V 2.5 i V6 2.5 i V6		09.98 08.99 09.98	12.00 12.00 07.99	BA2276 BA2286			21586 15,7 BDX 23410 15,7 +/WK BDX
<b>FORD ESCORT / ORION (91-94)</b>								
	1.1 1.3 1.4 1.6 1.8 D 1.8 i 16V 1.8 TD	77	09.90 09.90 09.90 09.90 09.90 01.92 02.93	01.95 01.95 01.95 01.95 01.95 01.95 01.95	BA2084		+ Feder <sup>1)</sup>	23300 18,0 + BDX
	1.1 1.3 Lim.		09.90 09.90	01.95 01.95	- ABS - ABS	BAR10196		239 10,0 8,0
	1.1 1.3 Kastenw. 1.3 Kombi 1.3 Lim. 1.4 1.6 1.8 D 1.8 i 16V 1.8 TD	77	09.90 09.90 09.90 09.90 09.90 09.90 01.92 02.93	01.95 01.95 01.95 01.95 01.95 01.95 01.95 01.95	+ ABS + ABS + ABS	BAR20147		240 20,0 18,0 V
	1.1 1.3 Lim. 1.4 Lim.		09.90 09.90 09.90	01.95 01.95 01.95	- ABS - ABS - ABS/ + Schaltgetriebe <sup>2)</sup>	BAW2007		Rz 20,64
	1.3 Kombi 1.4 Cabrio 1.4 Kombi 1.4 Lim. 1.6 1.8 D 1.8 i 16V 1.8 TD	77	09.90 09.90 09.90 09.90 09.90 09.90 01.92 02.93	01.95 01.95 01.95 01.95 01.95 01.95 01.95 01.95	- ABS - ABS - ABS - ABS/ + Automatikgetriebe <sup>4)</sup> - ABS - ABS/ - Kastenwagen <sup>5)</sup> - ABS	BAW1901	nur paarweise austauschen <sup>3)</sup>	Rz 19,05 LUC
	1.1		09.90	01.95	+ ABS	BAW2201		Rz 22,20

















1) + spring / + molla / + ressort / + muelle

2) - ABS/ + manual transmission / - ABS/+ scatola camb.velocità / - ABS/ + transmission mécanique / - ABS/ + cambio de velocidad

3) to change only by pairs / sostituire solo a coppie / à changer seulement par paires / cambiar solamente por parejas

4) - ABS/ + autom.transmission / - ABS/+ scatola cambio autom. / - ABS/ + transmission automatique / - ABS/ + cambio automático

5) - ABS/ - Van / - ABS/ - furgone / - ABS/ - fourgonnette / - ABS/ - furgón

        				
<b>FORD ESCORT / ORION (91-94)</b>				
 1.3 1.4 1.4 Kastenw. 1.8 D Kastenw.	09.90 01.95 + ABS 09.90 01.95 + ABS 09.90 01.95 09.90 01.95 - ABS	BAW2201		Rz 22,20
<b>FORD ESCORT VII (95-00)</b>				
 1.3 i 1.4 i 1.6 i 16V 1.8 D 1.8 i 16V 1.8 i 16V 1.8 TD	02.95 02.99 02.95 02.99 02.95 07.00 02.95 02.99 02.95 02.99 02.95 02.99 02.95 07.00	BA2084	+ Feder <sup>1)</sup>	23300 18,0 + BDX
 1.3 i 1.4 i 1.6 i 16V 1.8 D 1.8 i 16V 1.8 i 16V 1.8 TD	02.95 02.99 02.95 02.99 02.95 07.00 02.95 02.99 02.95 02.99 02.95 02.99 02.95 07.00	BAR20147		240 20,0 18,0 V
 1.3 i 1.4 i Cabrio 1.4 i Lim. 1.6 i 16V 1.8 D 1.8 D 1.8 i 16V 1.8 TD	02.95 07.95 - ABS 02.95 07.95 - ABS 02.95 07.95 - ABS 02.95 07.95 - ABS 08.95 02.99 08.95 02.99 02.95 07.00 - ABS	BAW2007		Rz 20,64
1.4 i Kombi 1.6 i 16V 1.8 D 1.8 i 16V Cabrio 1.8 TD	02.95 07.95 - ABS 02.95 07.95 02.95 07.95 - ABS 02.95 07.95 - ABS 02.95 07.95	BAW1901	nur paarweise austauschen <sup>2)</sup>	Rz 19,05 LUC
 1.3 i 1.3 i 1.4 i Cabrio 1.4 i Kastenw. 1.4 i Kombi 1.4 i Lim. 1.6 i 16V 1.8 D 1.8 D Kastenw. 1.8 i 16V 1.8 TD	08.95 02.99 - ABS 02.95 02.99 + ABS 08.95 02.99 02.95 02.99 08.95 02.99 08.95 02.99 08.95 07.00 02.95 07.95 + ABS 02.95 02.99 02.95 02.99 08.95 07.00	BAW2201		Rz 22,20
 1.3 i 1.4 i Lim. 1.6 i 16V 1.8 TD	02.95 02.99 - ABS 02.95 02.99 - ABS/+ Schaltgetriebe <sup>3)</sup> 02.95 07.00 - ABS 02.95 07.00 - ABS	BAE5004		180 x 32 HEB LUC
1.4 i Cabrio 1.4 i Kombi 1.4 i Lim. 1.6 i 16V 1.8 D 1.8 i 16V 1.8 TD	02.95 02.99 - ABS 02.95 02.99 - ABS 02.95 02.99 - ABS/+ Automatikgetriebe <sup>4)</sup> 02.95 07.00 - ABS 02.95 02.99 - ABS/- Kastenwagen <sup>5)</sup> 02.95 02.99 - ABS 02.95 07.00 - ABS	BAE5015		203 x 38 HEB
<b>FORD FIESTA III (89-96)</b>				
 1.1 1.3 Lim. 1.4 1.8 D Lim.	05.89 11.96 - SCS 01.91 11.96 - SCS 05.89 12.95 - SCS 05.89 11.96 - SCS	BA2146		21202 17,0 + ATE
1.1 1.3 Kastenw. 1.3 Lim. 1.4 1.6 1.6 XR2i 1.8 D Kastenw. 1.8 D Lim. 1.8 i 16V 1.8 i 16V XR2i	05.89 11.96 + SCS 08.91 11.96 01.91 11.96 + SCS 05.89 12.95 + SCS 05.89 01.94 05.89 12.92 08.91 11.96 05.89 11.96 + SCS 01.92 12.94 01.92 12.94	BA2144		20640 18,0 + ATE
 1.1 1.3 Lim. 1.4 1.8 D Lim.	05.89 11.96 - SCS 01.91 11.96 - SCS 05.89 12.95 - SCS 05.89 11.96 - SCS	BAR10196		239 10,0 8,0
1.1 1.3 Kastenw. 1.3 Lim. 1.4 1.6 1.6 XR2i 1.8 D Kastenw. 1.8 D Lim. 1.8 i 16V 1.8 i 16V XR2i	05.89 11.96 + SCS 08.91 11.96 01.91 11.96 + SCS 05.89 12.95 + SCS 05.89 01.94 05.89 12.92 08.91 11.96 05.89 11.96 + SCS 01.92 12.94 01.92 12.94	BAR20147		240 20,0 18,0 V

<sup>1)</sup> + spring / + molla / + ressort / + muelle

<sup>2)</sup> to change only by pairs / sostituire solo a coppie / à changer seulement par paires / cambiar solamente por parejas

<sup>3)</sup> - ABS/ + manual transmission / - ABS/+ scatola camb.velocità / - ABS/+ transmission mécanique / - ABS/+ cambio de velocidad

<sup>4)</sup> - ABS/ + autom.transmission / - ABS/+ scatola cambio autom. / - ABS/+ transmission automatique / - ABS/+ cambio automático





















<sup>5)</sup> - ABS/ - Van / - ABS/ - furgone / - ABS/ - fourgonnette / - ABS/ - furgón

















<b>FORD FIESTA III (89-96)</b>																			
	1.0	33	03.89	12.95	BAH0032	2												L=400	
	1.1	37	03.89	12.95															
	1.3	44	03.89	12.92															
	1.3 Kastenw.		08.91	02.96															
	1.3 KAT	44	05.91	12.95															
	1.4	52	03.89	12.95															
	1.4 KAT	54	03.89	12.95															
	1.6	65	01.89	01.94															
	1.6 Turbo	96	03.90	10.92															
	1.6 XR2i	81	03.89	01.94															
1.6i 16V	65	01.94	12.95																
1.8 16V	77	02.92	12.95																
1.8 D		05.89	12.96																
1.8 XR2i	96	02.92	12.95																
	1.0	33	03.89	12.95	BAH0030	2													L=295
	1.1	37	03.89	12.95 - SCS															
	1.3	44	03.89	12.92 - SCS															
	1.3 KAT	44	05.91	12.95															
	1.4	52	03.89	12.95 - SCS															
	1.4 KAT	54	03.89	12.95															
	1.6	65	01.89	01.94															
	1.6 Turbo	96	03.90	10.92															
	1.6 XR2i	81	03.89	01.94															
	1.6i 16V	65	01.94	12.95															
1.8 16V	77	02.92	12.95																
1.8 D Lim.		09.91	11.96 - SCS																
1.8 XR2i	96	02.92	12.95																
	1.1		01.94	11.96 - SCS	BAW1903														Rz 19,05
	1.3 Lim.		01.94	11.96 - SCS															
	1.4		01.94	12.95 - SCS															
	1.1		05.89	11.96 - SCS	BAE5021														180 x 32 AUT
	1.3 Lim.		01.91	11.96 - SCS															
	1.4		05.89	12.95 - SCS															
	1.8 D Lim.		05.89	11.96 - SCS															
<b>FORD FIESTA IV (96-02)</b>																			
	1.25 i 16V		01.96	01.00 + Schaltgetriebe <sup>1)</sup>	BA2146														21202 17,0 + ATE
	1.3 i Lim.		01.96	01.00															
	1.8 D Lim.		01.96	01.00															
	1.25 i 16V		01.96	01.00 + Automatikgetriebe <sup>2)</sup>	BA2144														20640 18,0 + ATE
	1.3 i Kastenw.		01.96	01.00															
	1.4 i 16V		02.96	01.00															
	1.6 i 16V		10.99	01.00															
	1.8 D Kastenw.		01.96	01.00															
	1.25 i 16V		02.00	03.02	BA2203														23200 18,8 + ATE
	1.3 i		02.00	03.02															
	1.4 i 16V		02.00	03.02	BA2199														23604 18,8 + ATE
	1.6 i 16V		02.00	03.02															
	1.8 D		02.00	03.02															
	1.8 DI		03.00	03.02															
	1.25 i 16V		01.96	01.00 + Schaltgetriebe <sup>1)</sup>															
1.3 i Lim.		01.96	01.00																
1.8 D Lim.		01.96	01.00																
	1.25 i 16V		01.96	01.00 + Automatikgetriebe <sup>2)</sup>	BAR20147														240 20,0 18,0 V
	1.3 i Kastenw.		01.96	01.00															
	1.4 i 16V		02.96	01.00															
	1.6 i 16V		10.99	01.00															
	1.8 D Kastenw.		01.96	01.00															
	1.25 i 16V		02.00	03.02	BAR20147														240 20,0 18,0 V
	1.3 i		02.00	03.02															
	1.4 i 16V		02.00	03.02	BAR22172														258 22,0 20,0 V
	1.6 i 16V		02.00	03.02															
	1.8 D		02.00	03.02															
	1.8 DI		03.00	03.02															
	1.25 i 16V		01.96	02.00															
1.3 i Lim.		01.96	02.00																
1.4 i 16V		02.96	02.00																
1.6 i 16V		10.99	02.00																
1.8 D Lim.		01.96	02.00																
	1.25 i 16V		01.96	01.00 + Schaltgetriebe <sup>1)</sup>	BAW1702														Rz 17,78 LUC
	1.3 i Lim.		01.96	01.00															
	1.8 D Lim.		01.96	01.00															
	1.25 i 16V		02.00	03.02 + Schaltgetriebe <sup>1)</sup>	BAW1914														Rz 19,05
	1.3 i Lim.		02.00	03.02															
	1.8 D Lim.		02.00	03.02															
	1.8 DI Lim.		03.00	03.02															
	1.25 i 16V		01.96	03.02 + Automatikgetriebe <sup>2)</sup>	BAW1901														Rz 19,05 LUC
	1.4 i 16V		02.96	03.02															
	1.6 i 16V		10.99	03.02															
	1.3 i Kastenw.		01.96	03.02	BAW2201														Rz 22,20
	1.8 D Kastenw.		01.96	03.02															
	1.8 DI Kastenw.		03.00	03.02															

<sup>1)</sup> + manual transmission / + scatola cambio velocità / + transmission mécanique / + cambio de velocidad

<sup>2)</sup> + autom.transmission / + scatola cambio automatico / + transmission automatique / + cambio automático

<sup>3)</sup> to change only by pairs / sostituire solo a coppie / à changer seulement par paires / cambiar solamente por parejas

								
<b>FORD FIESTA IV (96-02)</b>								
	1.25 i 16V 1.3 i Lim. 1.4 i 16V 1.6 i 16V 1.8 D Lim.		01.96 01.96 02.96 10.99 01.96	01.00 01.00 01.00 01.00 01.00	BAE5004			180 x 32 HEB LUC
	1.25 i 16V 1.3 i Lim. 1.4 i 16V 1.6 i 16V 1.8 D Lim. 1.8 DI Lim.		02.00 02.00 02.00 02.00 02.00 03.00	03.02 03.02 03.02 03.02 03.02 03.02	BAE5039 BAE5036	- ABS + ABS		180 x 32 HEB 203 x 38 HEB AP
	1.3 i Kastenw. 1.8 D Kastenw. 1.8 DI Kastenw.		01.96 01.96 03.00	03.02 03.02 03.02	BAE5015			203 x 38 HEB
<b>FORD FIESTA V (02-08)</b>								
	1.25 i 16V 1.25 i 16V 1.3 i 1.3 i 1.4 i 16V 1.4 TDCi 1.6 i 16V 1.6 TDCi	51 55 44 51 59 50 74 66	03.03 05.02 04.02 04.02 04.02 04.02 04.02 10.04	08.08 08.08 08.08 08.08 08.08 08.08 08.08 08.08	BA2199			23604 18,8 + ATE
	1.25 i 16V 1.25 i 16V 1.3 i 1.3 i 1.4 i 16V 1.4 TDCi 1.6 i 16V 1.6 TDCi	51 55 44 51 59 50 74 66	03.03 05.02 04.02 04.02 04.02 04.02 04.02 10.04	08.08 08.08 08.08 08.08 08.08 08.08 08.08 08.08	BAR22172			258 22,0 20,0 V
	ST 150	110	11.04	08.08	BA2208			23353 15,0 /WE/S LUC
	ST 150	110	11.04	08.08	BAR10115			253 10,2 8,9
	1.25 i 16V 1.25 i 16V 1.3 i 1.3 i 1.4 i 16V 1.4 TDCi 1.6 i 16V 1.6 TDCi	51 55 44 51 59 50 74 66	03.03 05.02 04.02 04.02 04.02 04.02 04.02 10.04	08.08 08.08 08.08 08.08 08.08 08.08 08.08 08.08	BAW1914			Rz 19,05
	1.25 i 16V 1.25 i 16V 1.3 i 1.3 i 1.4 i 16V 1.4 TDCi 1.6 i 16V 1.6 TDCi	51 55 44 51 59 50 74 66	03.03 05.02 04.02 04.02 04.02 04.02 04.02 10.04	08.08 08.08 08.08 08.08 08.08 08.08 08.08 08.08	BAE5036			203 x 38 HEB
<b>FORD FOCUS I (98-04)</b>								
	1.4 i 16V 1.6 i 16V 1.8 i 16V 1.8 TDCi 1.8 Turbo DI 2.0 i 16V		10.98 10.98 10.98 03.01 10.98 10.98	09.04 09.04 09.04 09.04 09.04 09.04	BA2209			23154 19,0 + ATE
	1.4 i 16V 1.6 i 16V 1.8 i 16V 1.8 TDCi 1.8 Turbo DI 2.0 i 16V		10.98 10.98 10.98 03.01 10.98 10.98	09.04 09.04 09.04 09.04 09.04 09.04	BAR22172			258 22,0 20,0 V
	1.4 i 16V 1.6 i 16V 1.8 i 16V 1.8 TDCi 1.8 Turbo DI 2.0 i 16V RS 2.0 ST 170		10.98 10.98 10.98 03.01 10.98 10.98 10.02 03.02	09.04 09.04 09.04 09.04 09.04 09.04 09.04 09.04	BA2208			23353 15,0 /WE/S LUC
	1.4 i 16V 1.6 i 16V 1.8 i 16V 1.8 TDCi 1.8 Turbo DI 2.0 i 16V		10.98 10.98 10.98 03.01 10.98 10.98	09.04 09.04 09.04 09.04 09.04 09.04	BAR10115			253 10,2 8,9

								
<b>FORD FOCUS I (98-04)</b>								
	1.4 i 16V Lim. 1.6 i 16V Lim. 1.8 i 16V Lim. 1.8 Turbo DI Kombi		10.98 10.98 10.98 10.98	09.04 09.04 09.04 09.04	BAW2007			Rz 20,64
	1.4 i 16V Kombi 1.6 i 16V Kombi 1.8 i 16V Kombi		10.98 10.98 10.98	09.04 09.04 09.04	BAW2201			Rz 22,20
	1.8 Turbo DI Lim.		10.98	09.04	BAW1901	nur paarweise austauschen <sup>1)</sup>		Rz 19,05 LUC
	1.4 i 16V 1.6 i 16V 1.8 i 16V 1.8 Turbo DI		10.98 10.98 10.98 10.98	09.04 09.04 09.04 09.04	BAE5041			203 x 38 HEB
<b>FORD FOCUS II (05-11)</b>								
	1.4 i 16V 1.6 i 16V 1.6 TDCi 1.6 TDCi 1.6 Ti VCT 1.8 i 16V 1.8 TDCi 2.0 i 16V 2.0 TDCi 2.0 TDCi	59 74 66 85 92 85 107 81	10.04 10.04 10.04 01.05 10.04 01.05 10.04 10.04 02.08	02.11 02.11 02.11 02.11 02.11 02.11 02.11 02.11 02.11	BA2234			23723 18,4 + ATE
	1.4 i 16V 1.6 i 16V 1.6 TDCi 1.6 TDCi 1.6 Ti VCT 1.8 i 16V 1.8 TDCi 2.0 i 16V 2.0 TDCi 2.0 TDCi	59 74 66 85 92 85 107 81	10.04 10.04 10.04 01.05 10.04 01.06 10.04 10.04 02.08	02.11 02.11 02.11 02.11 02.11 02.11 02.11 02.11 02.11	BAR25162	+ 17" Rad <sup>2)</sup>		300 25,0 23,0 V L
	1.4 i 16V 1.6 i 16V 1.6 TDCi 1.6 TDCi 1.6 Ti VCT 1.8 i 16V 1.8 TDCi 2.0 i 16V 2.0 TDCi 2.0 TDCi 2.5 ST 2.5 RS 2.5 RS 500	59 74 66 85 92 85 107 81 166 224 257	10.04 10.04 10.04 01.05 10.04 01.06 10.04 10.04 02.08 10.05 01.09 05.10	02.11 02.11 02.11 02.11 02.11 02.11 02.11 02.11 02.11 02.11 02.11 02.11	BA2258          BA2313			23482 16,4 + ATE          24537 15,8 / S LUC
<b>FORD FOCUS III (11-)</b>								
	1.0 EcoBoost 1.0 EcoBoost 1.6 EcoBoost 1.6 EcoBoost 1.6 LPG 1.6 TDCi 1.6 TDCi 1.6 Ti-VCT 1.6 Ti-VCT 1.6 Ti-VCT 1.6 Ti-VCT Flexifuel 2.0 TDCi 2.0 TDCi 2.0 TDCi 2.0 TDCi	74 92 110 134 88 70 85 63 77 92 88 85 100 103 120	02.12 02.12 03.11 03.11 02.12 03.11 03.11 08.11 03.11 03.11 03.11 03.11 03.11 03.11 03.11		BA2234			23723 18,4 + ATE
	1.6 EcoBoost 1.6 EcoBoost 2.0 TDCi 2.0 TDCi 2.0 TDCi 2.0 TDCi	110 134 85 100 103 120	03.11 03.11 03.11 03.11 03.11 03.11		BAR25162			300 25,0 23,0 V L
	1.0 EcoBoost 1.0 EcoBoost 1.6 EcoBoost 1.6 EcoBoost 1.6 LPG 1.6 TDCi 1.6 TDCi 1.6 Ti-VCT 1.6 Ti-VCT 1.6 Ti-VCT 1.6 Ti-VCT Flexifuel 2.0 TDCi 2.0 TDCi 2.0 TDCi 2.0 TDCi	74 92 110 134 88 70 85 63 77 92 88 85 100 103 120	02.12 02.12 03.11 03.11 02.12 03.11 03.11 08.11 03.11 03.11 03.11 03.11 03.11 03.11 03.11		BA2258			23482 16,4 + ATE





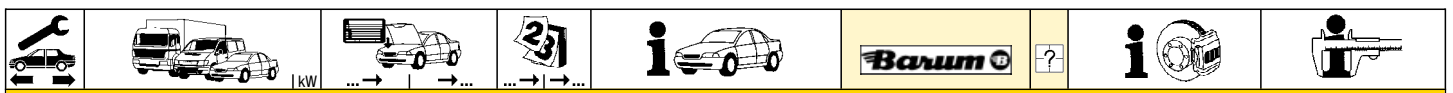















<sup>1)</sup> to change only by pairs / sostituire solo a coppie / à changer seulement par paires / cambiar solamente por parejas

<sup>2)</sup> + 17" wheel / + ruota 17" / + roue 17" / + rueda 17"



FORD FOCUS C-MAX (03-07)									
	1.6 i 16V 1.6 TDCi 1.6 TDCi 1.6 Ti VCT 1.8 i 16V 1.8 i 16V 1.8 TDCi 2.0 i 16V 2.0 TDCi	74 66 80 85 88 92 85 107 100		08.03 01.05 08.03 08.04 08.03 04.04 01.05 04.04 08.03	03.07 03.07 03.07 03.07 03.07 03.07 03.07 03.07 03.07	BA2234			23723 18,4 + ATE
	1.6 i 16V 1.6 TDCi 1.6 TDCi 1.6 Ti VCT 1.8 i 16V 1.8 i 16V 1.8 TDCi 2.0 i 16V 2.0 TDCi	74 66 80 85 88 92 85 107 100		08.03 01.05 08.03 08.04 08.03 04.04 01.05 04.04 08.03	03.07 03.07 03.07 03.07 03.07 03.07 03.07 03.07 03.07	BAR25162	+ 17" Rad <sup>1)</sup>		300 25,0 23,0 V L
	1.6 i 16V 1.6 TDCi 1.6 TDCi 1.6 Ti VCT 1.8 i 16V 1.8 i 16V 1.8 TDCi 2.0 i 16V 2.0 TDCi	74 66 80 85 88 92 85 107 100		08.03 01.05 08.03 08.04 08.03 04.04 01.05 04.04 08.03	03.07 03.07 03.07 03.07 03.07 03.07 03.07 03.07 03.07	BA2258			23482 16,4 + ATE
FORD FUSION (02-)									
	1.25 i 16V 1.4 i 16V 1.4 TDCi 1.6 i 16V 1.6 TDCi	55 59 50 74 66		08.04 07.02 07.02 07.02 10.04		BA2199			23604 18,8 + ATE
	1.25 i 16V 1.4 i 16V 1.4 TDCi 1.6 i 16V 1.6 TDCi	55 59 50 74 66		08.04 07.02 07.02 07.02 10.04		BAR22172			258 22,0 20,0 V
	1.25 i 16V 1.4 i 16V 1.4 TDCi 1.6 i 16V 1.6 TDCi	55 59 50 74 66		08.04 07.02 07.02 07.02 10.04		BAW1914			Rz 19,05
	1.25 i 16V 1.4 i 16V 1.4 TDCi 1.6 i 16V 1.6 TDCi	55 59 50 74 66		08.04 07.02 07.02 07.02 10.04		BAE5036			203 x 38 HEB
FORD GALAXY I (95-06)									
	1.9 TDI 1.9 TDI 2.0 i 2.3 i 16V 2.8 i V6	66 81 128		01.96 10.97 09.95 01.97 09.95	03.00 03.00 04.01 04.01 03.00	BA2147			21848 19,5 + ATE
	1.9 TDI 1.9 TDI	66 85		04.00 04.00	04.01 04.01	BA2269			21849 19,6 +/WK ATE
	1.9 TDI 1.9 TDI 1.9 TDI	66 85 96		05.01 05.01 02.03	04.06 04.06 04.06	BA2231			23418 19,6 +/WK ATE
	1.9 TDI 2.8 i V6	110 150		05.05 04.00	04.06 04.06	BA2318			23269 20,1 +/WK ATE
	1.9 TDI 1.9 TDI 1.9 TDI 2.0 i 2.3 i 16V 2.8 i V6	66 81 85 128		01.96 10.97 04.00 09.95 01.97 09.95	04.01 03.00 04.01 04.01 04.01 03.00	BAR25114			288 25,0 21,0 V L
	1.9 TDI 1.9 TDI 1.9 TDI 1.9 TDI 2.0 i 2.3 i 16V	66 85 96 110		05.01 05.01 02.03 05.05 05.01 05.01	04.06 04.06 04.06 04.06 04.06 04.06	BAR26115			300 26,0 22,0 V L
	1.9 TDI 1.9 TDI 2.0 i 2.3 i 16V 2.8 i V6	66 81 128		01.96 10.97 09.95 01.97 09.95	04.01 03.00 04.01 04.01 04.01	BAH0007	2		L=450
	1.9 TDI 1.9 TDI 1.9 TDI 1.9 TDI 2.0 i 2.3 i 16V	66 85 96 110		05.01 05.01 05.01 05.05 05.01 05.01	04.06 04.06 04.06 04.06 04.06 04.06	BAH0027	2		L=455













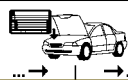













<sup>1)</sup> + 17" wheel / + ruota 17" / + roue 17" / + rueda 17"

												
<b>FORD GALAXY I (95-06)</b>												
	2.8 i V6	150		05.01	04.06		BAH0027	2	L=455			
	1.9 TDI	66		01.96	03.00		BA2017		20961 17,2 /S			
	1.9 TDI	81		10.97	03.00							
	2.0 i			09.95	04.06							
	2.3 i 16V			01.97	04.06							
	2.8 i V6	128		09.95	03.00		BA2228		20961 17,2 +/-WK/S			
	1.9 TDI	66		04.00	04.06							
	1.9 TDI	85		04.00	04.06							
	1.9 TDI	96		02.03	04.06							
	1.9 TDI	110		05.05	04.06							
	2.8 i V6	150		04.00	04.06							
	1.9 TDI	66		01.96	04.06		BAR10223		268 9,9 8,0			
	1.9 TDI	81		10.97	03.00							
	1.9 TDI	85		04.00	04.06							
	1.9 TDI	96		02.03	04.06							
	1.9 TDI	110		05.05	04.06							
	2.0 i			09.95	04.06							
	2.3 i 16V			01.97	04.06							
	2.8 i V6	128		09.95	03.00							
	2.8 i V6	150		04.00	04.06					BAR13194		294 13,5 11,5
<b>FORD GALAXY II (06-)</b>												
	1.6 EcoBoost	118		02.11			BA2314		24123 20,2 +			
	1.6 TDCi	85		02.11								
	1.8 TDCi	74		04.06								
	1.8 TDCi	92		04.06								
	2.0 Flexifuel	107		05.06								
	2.0 i 16V	107		04.06								
	2.0 TDCi	85		10.07								
	2.0 TDCi	96		04.06								
	2.0 TDCi	100		05.06								
	2.0 TDCi	103		04.06								
	2.0 TDCi	120		03.10								
	2.2 TDCi	129		11.08								
	2.2 TDCi	147		07.10								
	2.3 i 16V	118		07.07								
	1.6 EcoBoost	118		02.11			BA2313	+ mechanische Feststellbremse 1)	24537 15,8 /S			
	1.6 TDCi	85		02.11								
	1.8 TDCi	74		04.06								
	1.8 TDCi	92		04.06								
	2.0 Flexifuel	107		05.06								
	2.0 i 16V	107		04.06								
	2.0 SCTi EcoBoost	149		03.10								
	2.0 TDCi	85		10.07								
	2.0 TDCi	96		04.06								
	2.0 TDCi	100		05.06								
	2.0 TDCi	103		04.06								
	2.0 TDCi	120		03.10								
	2.2 TDCi	129		04.08								
	2.2 TDCi	147		07.10								
2.3 i 16V	118		07.07									
<b>FORD KA I (96-08)</b>												
	1.0 i			11.96	01.00		BA2146		21202 17,0 +			
	1.3 i			11.96	01.00							
	1.0 i			02.00	09.08					BA2203		23200 18,8 +
	1.3 i			02.00	09.08							
1.6 i	70		08.03	09.08		BA2199		23604 18,8 +				
	1.0 i			11.96	01.00		BAR12141		239 12,0 10,0			
	1.3 i			11.96	01.00							
	1.0 i			02.00	09.08					BAR20147		240 20,0 18,0 V
	1.3 i			02.00	09.08							
1.6 i	70		08.03	09.08		BAR22172		258 22,0 20,0 V				
	1.0 i			11.96	01.00		BAW1901	nur paarweise austauschen 2)	Rz 19,05			
	1.3 i			11.96	01.00							
	1.0 i			02.00	09.08					BAW1914		Rz 19,05
	1.3 i			02.00	09.08							
1.6 i	70		08.03	09.08		BAW1914		Rz 19,05				
	1.0 i			11.96	01.00		BAE5004		180 x 32 HEB			
	1.3 i			11.96	01.00							
	1.0 i			02.00	09.08					BAE5039		180 x 32 HEB
	1.3 i			02.00	09.08							
1.6 i	70		08.03	09.08		BAE5036		203 x 38 HEB				
<b>FORD KA II (09-)</b>												
	1.2 i 16V	51		02.09			BA2302		21436 17,0 /WK			
	1.2 i 16V	51		02.09			BAR11119		240 11,0 9,2			



















1) + mechanical parking brake / + fr. stazionamento meccanico / + frein à main mécanique / + freno de mano mecánica

2) to change only by pairs / sostituire solo a coppie / à changer seulement par paires / cambiar solamente por parejas

























								
<b>FORD KA II (09-)</b>								
	1.2 i 16V 1.3 TDCi	51 55	02.09 02.09	05.10 05.10	BAW2009			Rz 20,64 BDX
<b>FORD KUGA (08-)</b>								
	2.0 TDCi 2.0 TDCi 2.0 TDCi 4x4 2.0 TDCi 4x4 2.0 TDCi 4x4 2.5 i 2.5 i 4x4	100 103 100 103 120 147 147	04.08 03.10 04.08 03.10 03.10 03.09 11.08		BA2234			23723 18,4 + ATE
	2.0 TDCi 2.0 TDCi 2.0 TDCi 4x4 2.0 TDCi 4x4 2.0 TDCi 4x4 2.5 i 2.5 i 4x4	100 103 100 103 120 147 147	04.08 03.10 04.08 03.10 03.10 03.09 11.08		BAR25162			300 25,0 23,0 V L
	2.0 TDCi 2.0 TDCi 2.0 TDCi 4x4 2.0 TDCi 4x4 2.0 TDCi 4x4 2.5 i 2.5 i 4x4	100 103 100 103 120 147 147	04.08 03.10 04.08 03.10 03.10 03.09 11.08		BA2313			24537 15,8 /S LUC
<b>FORD MAVERICK (93-96)</b>								
	2.4 i 2.7 TD		02.93 02.93	09.96 09.96	BA2119			21481 15,5 LUC
	2.4 i 2.7 TD		02.93 02.93	09.96 09.96	BAR26109			277 26,0 24,0 V
<b>FORD MAVERICK (97-98)</b>								
	2.4 i 2.7 TD		10.96 10.96	03.98 03.98	BA2119			21481 15,5 LUC
	2.4 i 2.7 TD		10.96 10.96	03.98 03.98	BAR26109			277 26,0 24,0 V
<b>FORD MONDEO I (93-96)</b>								
	1.6 i 16V 1.8 i 16V 1.8 TD 2.0 i 16V		01.93 01.93 01.93 01.93	09.96 09.96 09.96 09.96	BA2139 BA2138			21394 18,0 + 21396 18,0 +/WK ATE ATE
	1.6 i 16V 1.8 i 16V 1.8 TD 2.0 i 16V		01.93 01.93 01.93 01.93	09.96 09.96 09.96 09.96	BAR24120			260 24,0 22,2 V
	1.8 i 16V 1.8 TD 2.0 i 16V 2.5 i 24V		01.93 01.93 01.93 08.94	09.96 09.96 09.96 09.96	BA2276 BA2286		- Ghia Modelle <sup>1)</sup> + Ghia Modelle <sup>2)</sup>	21586 15,7 23410 15,7 +/WK BDX BDX
	1.6 i 16V Lim. 1.8 i 16V Lim. 1.8 TD Lim. 2.0 i 16V Lim.		06.94 06.94 06.94 06.94	09.96 09.96 09.96 09.96	BAW2203			Rz 22,20
	1.6 i 16V Lim. 1.8 i 16V Lim. 1.8 TD Lim. 2.0 i 16V Lim.		01.93 01.93 01.93 01.93	05.94 05.94 05.94 05.94	BAE5030			228 x 45 HEB
	1.6 i 16V Lim. 1.8 i 16V Lim. 1.8 TD Lim. 2.0 i 16V Lim.		06.94 06.94 06.94 06.94	09.96 09.96 09.96 09.96	BAE5031			203 x 39 HEB
	1.6 i 16V Kombi 1.8 i 16V Kombi 1.8 TD Kombi 2.0 i 16V Kombi		01.93 01.93 01.93 01.93	09.96 09.96 09.96 09.96	BAE5030			228 x 45 HEB
<b>FORD MONDEO II (96-00)</b>								
	1.6 i 16V 1.8 i 16V 1.8 TD 2.0 i 16V 2.5 i 24V 2.5 ST 200		10.96 10.96 10.96 10.96 12.97 05.99	09.00 09.00 09.00 09.00 09.00 09.00	BA2139 BA2138			21394 18,0 + 21396 18,0 +/WK ATE ATE
	1.6 i 16V 1.8 i 16V 1.8 TD 2.0 i 16V		10.96 10.96 10.96 10.96	09.00 09.00 09.00 09.00	BAR24120			260 24,0 22,2 V





















<sup>1)</sup> - Ghia model / - modello Ghia / - modèles Ghia / - modelo Ghia  
<sup>2)</sup> + Ghia model / + modello Ghia / + modèles Ghia / + modelo Ghia

									
<b>FORD MONDEO II (96-00)</b>									
	1.6 i 16V 1.8 i 16V 1.8 TD 2.0 i 16V 2.5 i 24V 2.5 ST 200		10.96 09.00 10.96 09.00 10.96 09.00 10.96 09.00 10.96 09.00 05.99 09.00		BA2276 BA2286		- Ghia Modelle <sup>1)</sup> + Ghia Modelle <sup>2)</sup>	21586 15,7 23410 15,7 +/WK	BDX BDX
	1.6 i 16V Lim. 1.8 i 16V Lim. 1.8 TD Lim.		10.96 09.00 10.96 09.00 10.96 09.00		BAW2203			Rz 22,20	
	1.6 i 16V Lim. 1.8 i 16V Lim. 1.8 TD Lim.		10.96 09.00 10.96 09.00 10.96 09.00		BAE5031			203 x 39 HEB	
	1.6 i 16V Kombi 1.8 i 16V Kombi 2.0 i 16V Lim.		10.96 09.00 10.96 09.00 10.96 09.00		BAE5030			228 x 45 HEB	
<b>FORD MONDEO III (00-06)</b>									
	1.8 i 16V 1.8 SCi 2.0 DI 2.0 i 16V 2.0 TDCi 2.2 TDCi 2.5 i V6 3.0 i V6 ST 220		10.00 03.07 06.03 03.07 10.00 03.07 10.00 03.07 10.01 03.07 09.04 03.07 10.00 03.07 09.04 03.07 04.02 03.07		BA2224			23279 18,5 /S	BOS
	1.8 i 16V 1.8 SCi 2.0 DI 2.0 i 16V 2.0 TDCi 2.2 TDCi 2.5 i V6 3.0 i V6 ST 220		10.00 03.07 06.03 03.07 10.00 03.07 10.00 03.07 10.01 03.07 09.04 03.07 10.00 03.07 09.04 03.07 04.02 03.07		BAR24161			300 24,0 22,0 V	
	1.8 i 16V 1.8 SCi 2.0 DI 2.0 i 16V 2.0 TDCi 2.5 i V6 ST 220		10.00 08.04 06.03 08.04 10.00 08.04 10.00 08.04 10.01 08.04 10.00 08.04 04.02 08.04		BA2225			23557 17,2 /S	BOS
	1.8 i 16V 1.8 SCi 2.0 DI 2.0 i 16V 2.0 TDCi 2.2 TDCi 2.5 i V6 3.0 i V6 ST 220		09.04 03.07 09.04 03.07 09.04 03.07 09.04 03.07 09.04 03.07 09.04 03.07 09.04 03.07 09.04 03.07		BA2287			24260 16,9 /S	BOS
	1.8 i 16V 1.8 SCi 2.0 DI 2.0 i 16V 2.0 TDCi 2.2 TDCi 2.5 i V6 3.0 i V6 ST 220		10.00 03.07 06.03 03.07 10.00 03.07 10.00 03.07 10.01 03.07 09.04 03.07 10.00 03.07 09.04 03.07 04.02 03.07		BAR12154			280 12,0 10,0	
<b>FORD MONDEO IV (07-)</b>									
	1.6 EcoBoost 118 1.6 TDCi 85 1.6 Ti VCT 81 1.6 Ti VCT 92 1.8 TDCi 74 1.8 TDCi 92 2.0 Flexifuel 107 2.0 i 16V 107 2.0 LPG 107 2.0 SCTi EcoBoost 149 2.0 TDCi 85 2.0 TDCi 96 2.0 TDCi 100 2.0 TDCi 103 2.0 TDCi 120 2.2 TDCi 129 2.2 TDCi 147 2.3 i 16V 118 2.5 i 20V 162		02.11 02.11 04.07 04.07 04.07 06.07 03.07 04.07 07.09 03.10 10.07 04.07 03.09 04.07 03.10 04.08 11.10 07.07 04.07		BA2314			24123 20,2 +	ATE
	1.6 EcoBoost 118 1.6 TDCi 85 1.6 Ti VCT 81 1.6 Ti VCT 92 1.8 TDCi 74		02.11 02.11 04.07 04.07 04.07		BA2313			24537 15,8 /S	LUC

<sup>1)</sup> - Ghia model / - modello Ghia / - modèles Ghia / - modelo Ghia  
<sup>2)</sup> + Ghia model / + modello Ghia / + modèles Ghia / + modelo Ghia

									
<b>FORD MONDEO IV (07-)</b>									
	1.8 TDCi 92 2.0 Flexifuel 107 2.0 i 16V 107 2.0 LPG 107 2.0 SCTi EcoBoost 149 2.0 TDCi 85 2.0 TDCi 96 2.0 TDCi 100 2.0 TDCi 103 2.0 TDCi 120 2.2 TDCi 129 2.2 TDCi 147 2.3 i 16V 118 2.5 i 20V 162		06.07 03.07 04.07 07.09 03.10 10.07 04.07 03.09 04.07 03.10 04.08 11.10 07.07 04.07			BA2313			24537 15,8 /S LUC
<b>FORD PROBE (93-97)</b>									
	2.0 i 16V 2.5 i 24V		01.94 09.97 01.93 09.97			BA2118			21754 15,8 +/WK SUM
	2.0 i 16V 2.5 i 24V		01.94 09.97 01.93 09.97			BAR24129			258 24,0 22,0 V
<b>FORD PUMA (97-01)</b>									
	1.4 i 16V 1.7 i 16V ST 160		02.98 01.00 06.97 01.00 06.99 01.00			BA2144			20640 18,0 + ATE
	1.4 i 16V 1.6 i 16V 1.7 i 16V ST 160		02.00 10.00 08.00 12.01 02.00 12.01 02.00 12.01			BA2199			23604 18,8 + ATE
	1.4 i 16V 1.7 i 16V ST 160		02.98 01.00 06.97 01.00 06.99 01.00			BAR20147			240 20,0 18,0 V
	1.4 i 16V 1.6 i 16V 1.7 i 16V ST 160		02.00 10.00 08.00 12.01 02.00 12.01 02.00 12.01			BAR22172			258 22,0 20,0 V
	1.4 i 16V 1.7 i 16V		02.98 12.99 02.98 12.99			BAH0029	2		L=300
	1.4 i 16V 1.7 i 16V ST 160		02.98 01.00 06.97 01.00 06.99 01.00			BAW1702	nur paarweise austauschen <sup>1)</sup>		Rz 17,78 LUC
	1.4 i 16V 1.6 i 16V 1.7 i 16V ST 160		02.00 10.00 08.00 12.01 02.00 12.01 02.00 12.01			BAW1914			Rz 19,05
	1.4 i 16V 1.7 i 16V ST 160		02.98 01.00 06.97 01.00 06.99 01.00			BAE5004			180 x 32 HEB LUC
	1.4 i 16V 1.6 i 16V 1.7 i 16V ST 160		02.00 10.00 08.00 12.01 02.00 12.01 02.00 12.01			BAE5036			203 x 38 HEB
<b>FORD SCORPIO / GRANADA (GB) (95-98)</b>									
	2.0 i 2.3 i 16V 2.5 TD 2.9 i		10.94 08.98 05.96 08.98 10.94 08.98 01.95 08.98			BA2139			21394 18,0 + ATE
	2.0 i 2.3 i 16V 2.5 TD 2.9 i		10.94 08.98 05.96 08.98 10.94 08.98 01.95 08.98			BAR24120			260 24,0 22,2 V
	2.0 i 2.3 i 16V 2.5 TD 2.9 i 2.9 i 24V		10.94 08.98 05.96 08.98 10.94 08.98 01.95 08.98 10.94 08.98			BA2030			20981 13,7 /S LUC
	2.0 i Lim. 2.3 i 16V Lim. 2.5 TD Lim. 2.9 i Lim.		10.94 08.98 05.96 08.98 10.94 08.98 01.95 08.98			BAR10115			253 10,2 8,9
<b>FORD S-MAX (06-)</b>									
	1.6 EcoBoost 118 1.6 TDCi 85 1.8 TDCi 74 1.8 TDCi 92 2.0 i 16V 107 2.0 TDCi 85 2.0 TDCi 96 2.0 TDCi 100 2.0 TDCi 103		02.11 02.11 01.07 04.06 04.06 10.07 04.06 05.06 04.06			BA2314			24123 20,2 + ATE

<sup>1)</sup> to change only by pairs / sostituire solo a coppie / à changer seulement par paires / cambiar solamente por parejas

								
<b>FORD S-MAX (06-)</b>								
	2.0 TDCi	120		03.10		BA2314		24123 20,2 + ATE
	2.2 TDCi	129		11.08				
	2.2 TDCi	147		07.10				
	2.3 i 16V	118		07.07				
	1.6 EcoBoost	118		02.11		BA2313	+ mechanische Feststellbremse <sup>1)</sup>	24537 15,8 / S LUC
	1.6 TDCi	85		02.11				
	1.8 TDCi	74		01.07				
	1.8 TDCi	92		04.06				
	2.0 EcoBoost	176		07.10				
	2.0 i 16V	107		04.06				
	2.0 SCTi EcoBoost	149		03.10				
	2.0 TDCi	85		10.07				
	2.0 TDCi	96		04.06				
	2.0 TDCi	100		05.06				
	2.0 TDCi	103		04.06				
	2.0 TDCi	120		03.10				
	2.2 TDCi	129		04.08				
	2.2 TDCi	147		07.10				
	2.3 i 16V	118		07.07				
	2.5 ST	162		04.06				
<b>FORD STREET KA (03-06)</b>								
	1.6 i	70		02.03	02.06	BA2199		23604 18,8 + ATE
	1.6 i	70		02.03	02.06	BAR22172		258 22,0 20,0 V
	1.6 i	70		02.03	02.06	BAW1914		Rz 19,05
	1.6 i	70		02.03	02.06	BAE5036		203 x 38 HEB
<b>FORD TOURNEO (94-00)</b>								
	2.0			07.94	03.00 + 14" Rad <sup>2)</sup>	BA2081		21470 19,0 /WE BDX
	2.5 D			07.94	03.00 + 14" Rad <sup>2)</sup>			
	2.5 TD			07.94	03.00 + 14" Rad <sup>2)</sup>			
	2.0			07.94	03.00 + 15" Rad <sup>3)</sup>	BA2080		21469 19,0 /WE BDX
	2.5 D			07.94	03.00 + 15" Rad <sup>3)</sup>			
	2.5 TD			07.94	03.00 + 15" Rad <sup>3)</sup>			
	2.0			07.94	03.00 + 14" Rad <sup>2)</sup>	BAR24131		254 24,3 22,2 V
	2.5 D			07.94	03.00 + 14" Rad <sup>2)</sup>			
	2.5 TD			07.94	03.00 + 14" Rad <sup>2)</sup>			
	2.0			07.94	03.00 + 15" Rad <sup>3)</sup>	BAR24132		270 24,3 22,2 V
	2.5 D			07.94	03.00 + 15" Rad <sup>3)</sup>			
	2.5 TD			07.94	03.00 + 15" Rad <sup>3)</sup>			
	2.5 D			07.94	03.00	BAW2010		Rz 20,64
	2.5 TD			07.94	03.00			
	2.0			07.94	03.00 + 80-120	BAE5034	+ Einfachbereifung <sup>4)</sup>	254 x 52
	2.5 D			07.94	03.00 + 80-120			
	2.5 TD			07.94	03.00 + 80-120			
<b>FORD TOURNEO CONNECT (03-)</b>								
	1.8 DI	55		09.02	+ ABS	BA2238		23482 16,4 + ATE
	1.8 i 16V	86		09.02	+ ABS	BA2235		23482 16,4 + ATE
	1.8 TDCi			09.02	+ ABS			
<b>FORD TRANSIT (92-94)</b>								
	2.0 Bus	66		09.91	09.94	BA2081	+ 14" Rad <sup>2)</sup>	21470 19,0 /WE BDX
	2.0 i Bus	72		09.91	07.94			
	2.0 i Kasten	72		09.91	06.94			
	2.0 Kasten	66		09.91	06.94			
	2.0 Pritsche/Fahrg.	72		09.91	08.94			
	2.5 DI Bus	51		08.91	07.94			
	2.5 DI Bus	59		09.91	07.94			
	2.5 DI Kasten	51		05.91	06.94			
	2.5 DI Kasten	59		05.91	06.94			
	2.5 DI Kasten	63		10.92	06.94			
	2.5 DI Prits./Fahrg.	51		09.91	08.94			
	2.5 DI Prits./Fahrg.	59		09.91	08.94			
	2.5 TD Bus	63		10.92	07.94			
	2.5 TD Bus	74		09.91	07.94			
	2.5 TD Kasten	74		05.91	06.94			
	2.5 TD Prits./Fahrg.	63		11.92	08.94			
	2.5 TD Prits./Fahrg.	74		09.91	08.94			
	2.9 i Bus	107		01.91	08.94			
	2.0 Bus	66		09.91	09.94	BA2080	+ 15" Rad <sup>3)</sup>	21469 19,0 /WE BDX
	2.0 i Bus	72		09.91	07.94			
	2.0 i Kasten	72		09.91	06.94			
	2.0 Kasten	66		09.91	06.94			
	2.0 Pritsche/Fahrg.	72		09.91	08.94			
	2.5 DI Bus	51		08.91	07.94			

<sup>1)</sup> + mechanical parking brake / + fr. stazionamento meccanico / + frein à main mécanique / + freno de mano mecánica

<sup>2)</sup> + 14" wheel / + ruota 14" / + roue 14" / + rueda 14"

<sup>3)</sup> + 15" wheel / + ruota 15" / + roue 15" / + rueda 15"

<sup>4)</sup> + single tyre / + ruota singola / + roue simple / + cubierta simple

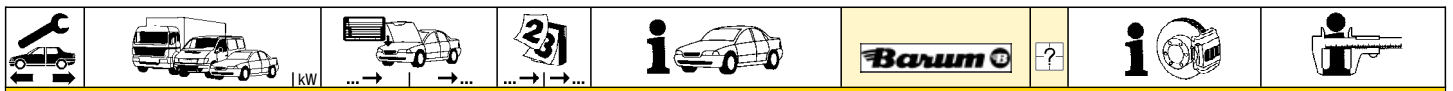

**FORD TRANSIT (92-94)**

	2.5 DI Bus 59 2.5 DI Kasten 51 2.5 DI Kasten 59 2.5 DI Kasten 63 2.5 DI Prits./Fahrg. 51 2.5 DI Prits./Fahrg. 59 2.5 TD Bus 63 2.5 TD Bus 74 2.5 TD Kasten 74 2.5 TD Prits./Fahrg. 63 2.5 TD Prits./Fahrg. 74 2.9 i Bus 107		09.91 07.94 05.91 06.94 05.91 06.94 10.92 06.94 09.91 08.94 09.91 08.94 10.92 07.94 09.91 07.94 05.91 06.94 11.92 08.94 09.91 08.94 01.91 08.94	BA2080	+ 15" Rad <sup>1)</sup>	21469 19,0 /WE BDX
	2.0 Bus 66 2.0 i Bus 72 2.0 i Kasten 72 2.0 Kasten 66 2.0 Pritsche/Fahrg. 72 2.5 DI Bus 51 2.5 DI Bus 59 2.5 DI Kasten 51 2.5 DI Kasten 59 2.5 DI Kasten 63 2.5 DI Prits./Fahrg. 51 2.5 DI Prits./Fahrg. 59 2.5 TD Bus 63 2.5 TD Bus 74 2.5 TD Kasten 74 2.5 TD Prits./Fahrg. 63 2.5 TD Prits./Fahrg. 74 2.9 i Bus 107		09.91 09.94 09.91 07.94 09.91 06.94 09.91 06.94 09.91 08.94 08.91 07.94 09.91 07.94 05.91 06.94 05.91 06.94 10.92 06.94 09.91 08.94 09.91 08.94 10.92 07.94 09.91 07.94 05.91 06.94 11.92 08.94 09.91 08.94 01.91 08.94	BAR24131	+ 14" Rad <sup>2)</sup>	254 24,3 22,2 V
	2.0 Bus 66 2.0 i Bus 72 2.0 i Kasten 72 2.0 Kasten 66 2.0 Pritsche/Fahrg. 72 2.5 DI Bus 51 2.5 DI Bus 59 2.5 DI Kasten 51 2.5 DI Kasten 59 2.5 DI Kasten 63 2.5 DI Prits./Fahrg. 51 2.5 DI Prits./Fahrg. 59 2.5 TD Bus 63 2.5 TD Bus 74 2.5 TD Kasten 74 2.5 TD Prits./Fahrg. 63 2.5 TD Prits./Fahrg. 74 2.9 i Bus 107		09.91 09.94 09.91 07.94 09.91 06.94 09.91 06.94 09.91 08.94 08.91 07.94 09.91 07.94 05.91 06.94 05.91 06.94 10.92 06.94 09.91 08.94 09.91 08.94 10.92 07.94 09.91 07.94 05.91 06.94 11.92 08.94 09.91 08.94 01.91 08.94	BAR24132	+ 15" Rad <sup>1)</sup>	270 24,3 22,2 V
	2.5 DI Bus 51 2.5 DI Bus 59 2.5 DI Kasten 51 2.5 DI Kasten 59 2.5 DI Kasten 63 2.5 DI Prits./Fahrg. 51 2.5 DI Prits./Fahrg. 59 2.5 TD Bus 63 2.5 TD Bus 74 2.5 TD Kasten 74 2.5 TD Prits./Fahrg. 63 2.5 TD Prits./Fahrg. 74		08.91 07.94 FT80/100S/100L/115/120 09.91 07.94 FT80/100S/100L/115/120 05.91 06.94 FT80/100S/100L/115/120 05.91 06.94 FT80/100S/100L/115/120 10.92 06.94 FT80/100S/100L/115/120 09.91 08.94 FT80/100S/100L/115/120 09.91 08.94 FT80/100S/100L/115/120 10.92 07.94 FT80/100S/100L/115/120 09.91 07.94 FT80/100S/100L/115/120 05.91 06.94 FT80/100S/100L/115/120 11.92 08.94 FT80/100S/100L/115/120 09.91 08.94 FT80/100S/100L/115/120	BAW2010		Rz 20,64
	2.0 Bus 66 2.0 i Bus 72 2.0 i Kasten 72 2.0 Kasten 66 2.0 Pritsche/Fahrg. 72 2.5 DI Bus 51 2.5 DI Bus 59 2.5 DI Kasten 51 2.5 DI Kasten 59 2.5 DI Kasten 63 2.5 DI Prits./Fahrg. 51 2.5 DI Prits./Fahrg. 59 2.5 TD Bus 63 2.5 TD Bus 74 2.5 TD Kasten 74 2.5 TD Prits./Fahrg. 63 2.5 TD Prits./Fahrg. 74 2.9 i Bus 107		09.91 09.94 FT130/150S/150L 09.91 07.94 FT130/150S/150L 09.91 06.94 FT130/150S/150L 09.91 06.94 FT130/150S/150L 09.91 08.94 FT130/150S/150L 08.91 07.94 FT130/150S/150L 09.91 07.94 FT130/150S/150L 05.91 06.94 FT130/150S/150L 05.91 06.94 FT130/150S/150L 10.92 06.94 FT130/150S/150L 09.91 08.94 FT130/150S/150L 09.91 08.94 FT130/150S/150L 10.92 07.94 FT130/150S/150L 09.91 07.94 FT130/150S/150L 05.91 06.94 FT130/150S/150L 11.92 08.94 FT130/150S/150L 09.91 08.94 FT130/150S/150L 01.91 08.94 FT130/150S/150L	BAW2010		Rz 20,64
	2.0 Bus 66 2.0 i Bus 72 2.0 i Kasten 72 2.0 Kasten 66 2.0 Pritsche/Fahrg. 72 2.5 DI Bus 51 2.5 DI Bus 59 2.5 DI Kasten 51 2.5 DI Kasten 59		09.91 09.94 FT190/190A/190EF 09.91 07.94 FT190/190A/190EF 09.91 06.94 FT190/190A/190EF 09.91 06.94 FT190/190A/190EF 09.91 08.94 FT190/190A/190EF 08.91 07.94 FT190/190A/190EF 09.91 07.94 FT190/190A/190EF 05.91 06.94 FT190/190A/190EF 05.91 06.94 FT190/190A/190EF	BAW2500		Rz 25,40

<sup>1)</sup> + 15" wheel / + ruota 15" / + roue 15" / + rueda 15"

<sup>2)</sup> + 14" wheel / + ruota 14" / + roue 14" / + rueda 14"

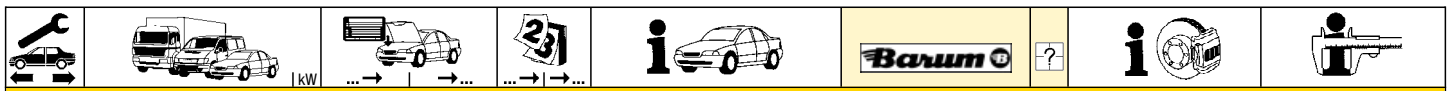





















FORD TRANSIT (92-94)										
	2.5 DI Kasten	63								Rz 25,40
	2.5 DI Prits./Fahrg.	51	10.92	06.94	FT190/190A/190EF	BAW2500				
	2.5 DI Prits./Fahrg.	59	09.91	08.94	FT190/190A/190EF					
	2.5 TD Bus	63	09.91	08.94	FT190/190A/190EF					
	2.5 TD Bus	74	10.92	07.94	FT190/190A/190EF					
	2.5 TD Kasten	74	09.91	07.94	FT190/190A/190EF					
	2.5 TD Prits./Fahrg.	63	05.91	06.94	FT190/190A/190EF					
	2.5 TD Prits./Fahrg.	74	11.92	08.94	FT190/190A/190EF					
	2.5 TD Prits./Fahrg.	74	09.91	08.94	FT190/190A/190EF					
	2.9 i Bus	107	01.91	08.94	FT190/190A/190EF					

FORD TRANSIT (95-00)										
	2.0 Bus	84	09.95	03.00		BA2081		+ 14" Rad <sup>1)</sup>	21470 19,0 /WE	BDX
	2.0 CNG Bus	84	06.94	03.00						
	2.0 Kasten	84	06.94	03.00						
	2.0 Pritsche/Fahrg.	84	08.94	03.00						
	2.5 DI Bus	51	08.94	03.00						
	2.5 DI Bus	56	07.94	03.00						
	2.5 DI Bus	85	08.97	03.00						
	2.5 DI Kasten	51	06.94	03.00						
	2.5 DI Kasten	56	06.94	03.00						
	2.5 DI Kasten	85	05.99	03.00						
	2.5 DI Prits./Fahrg.	51	08.94	03.00						
	2.5 DI Prits./Fahrg.	56	08.94	03.00						
	2.5 DI Prits./Fahrg.	85	05.99	03.00						
	2.5 TD Bus	55	08.94	03.00						
	2.5 TD Bus	63	01.95	03.00						
	2.5 TD Bus	74	07.94	03.00						
	2.5 TD Kasten	55	10.98	03.00						
	2.5 TD Kasten	63	06.94	03.00						
	2.5 TD Kasten	74	06.94	03.00						
	2.5 TD Prits./Fahrg.	55	10.98	03.00						
	2.5 TD Prits./Fahrg.	63	08.94	03.00						
	2.5 TD Prits./Fahrg.	74	08.94	03.00						
	2.0 Bus	84	09.95	03.00		BA2080		+ 15" Rad <sup>2)</sup>	21469 19,0 /WE	BDX
	2.0 CNG Bus	84	06.94	03.00						
	2.0 Kasten	84	06.94	03.00						
	2.0 Pritsche/Fahrg.	84	08.94	03.00						
	2.5 DI Bus	51	08.94	03.00						
	2.5 DI Bus	56	07.94	03.00						
	2.5 DI Bus	85	08.97	03.00						
	2.5 DI Kasten	51	06.94	03.00						
	2.5 DI Kasten	56	06.94	03.00						
	2.5 DI Kasten	85	05.99	03.00						
	2.5 DI Prits./Fahrg.	51	08.94	03.00						
	2.5 DI Prits./Fahrg.	56	08.94	03.00						
	2.5 DI Prits./Fahrg.	85	05.99	03.00						
	2.5 TD Bus	55	08.94	03.00						
	2.5 TD Bus	63	01.95	03.00						
	2.5 TD Bus	74	07.94	03.00						
	2.5 TD Kasten	55	10.98	03.00						
	2.5 TD Kasten	63	06.94	03.00						
	2.5 TD Kasten	74	06.94	03.00						
	2.5 TD Prits./Fahrg.	55	10.98	03.00						
	2.5 TD Prits./Fahrg.	63	08.94	03.00						
	2.5 TD Prits./Fahrg.	74	08.94	03.00						
	2.0 Bus	84	09.95	03.00		BAR24131		+ 14" Rad <sup>1)</sup>	254 24,3 22,2 V	
	2.0 CNG Bus	84	06.94	03.00						
	2.0 Kasten	84	06.94	03.00						
	2.0 Pritsche/Fahrg.	84	08.94	03.00						
	2.5 DI Bus	51	08.94	03.00						
	2.5 DI Bus	56	07.94	03.00						
	2.5 DI Bus	85	08.97	03.00						
	2.5 DI Kasten	51	06.94	03.00						
	2.5 DI Kasten	56	06.94	03.00						
	2.5 DI Kasten	85	05.99	03.00						
	2.5 DI Prits./Fahrg.	51	08.94	03.00						
	2.5 DI Prits./Fahrg.	56	08.94	03.00						
	2.5 DI Prits./Fahrg.	85	05.99	03.00						
	2.5 TD Bus	55	08.94	03.00						
	2.5 TD Bus	63	01.95	03.00						
	2.5 TD Bus	74	07.94	03.00						
	2.5 TD Kasten	55	10.98	03.00						
	2.5 TD Kasten	63	06.94	03.00						
	2.5 TD Kasten	74	06.94	03.00						
	2.5 TD Prits./Fahrg.	55	10.98	03.00						
	2.5 TD Prits./Fahrg.	63	08.94	03.00						
	2.5 TD Prits./Fahrg.	74	08.94	03.00						
	2.0 Bus	84	09.95	03.00		BAR24132		+ 15" Rad <sup>2)</sup>	270 24,3 22,2 V	
	2.0 CNG Bus	84	06.94	03.00						
	2.0 Kasten	84	06.94	03.00						
	2.0 Pritsche/Fahrg.	84	08.94	03.00						
	2.5 DI Bus	51	08.94	03.00						
	2.5 DI Bus	56	07.94	03.00						
	2.5 DI Bus	85	08.97	03.00						
	2.5 DI Kasten	51	06.94	03.00						
	2.5 DI Kasten	56	06.94	03.00						
	2.5 DI Kasten	85	05.99	03.00						

<sup>1)</sup> + 14" wheel / + ruota 14" / + roue 14" / + rueda 14"

<sup>2)</sup> + 15" wheel / + ruota 15" / + roue 15" / + rueda 15"

























































								
<b>FORD TRANSIT (00-06)</b>								
	2.4 DI 2.4 DI RWD 2.4 TD Allrad 2.4 TDCi 2.4 TDCi RWD 2.4 TDE 2.4 TDE RWD	55 101	01.00 01.00 08.00 03.04 03.04 11.01 11.01	04.06 04.06 04.06 04.06 04.06 04.06 04.06	BAW2500			Rz 25,40
	2.0 DI 2.0 TDCi 2.3 i 16V 2.4 DI 2.4 TDCi 2.4 TDE		08.00 08.02 04.01 01.00 03.04 11.01	04.06 04.06 04.06 04.06 04.06 04.06	BAE5018			254 x 52 HEB
	2.0 RWD 2.3 16V RWD 2.4 DI RWD 2.4 TD Allrad 2.4 TDCi RWD 2.4 TDE RWD	84 55 101	08.00 08.00 01.00 08.00 03.04 11.01	04.06 04.06 04.06 04.06 04.06 04.06	BAE5028			280 x 65 HEB
<b>FORD TRANSIT (06-)</b>								
	2.2 TDCi 2.2 TDCi 2.2 TDCi 4x4 2.2 TDCi RWD 2.3 16V RWD 2.4 TDCi 4x4 2.4 TDCi RWD 3.2 TDCi RWD		05.06 05.06 10.11 10.11 05.06 05.06 05.06 09.07	Serie 260/280/300 <sup>1)</sup> Serie 330/350 <sup>2)</sup>	BA2305 BA2306 BA2306			24485 18,8 /WK/S BOS 24484 18,8 /WK/S BOS 24484 18,8 /WK/S BOS
	2.2 TDCi 2.2 TDCi 4x4 2.2 TDCi RWD 2.4 TDCi 4x4 2.4 TDCi RWD 3.2 TDCi RWD		05.06 10.11 10.11 05.06 05.06 09.07		BA2304			24486 17,3 /WK/S BOS
	2.2 TDCi		05.06		BAW2500			Rz 25,40
	2.2 TDCi		05.06		BAE5018			254 x 52 HEB
<b>FORD TRANSIT CONNECT (03-)</b>								
	1.8 DI 1.8 i 16V 1.8 TDCi 1.8 TDCi	55 86 66 81	01.03 01.03 01.03 08.06	+ ABS + ABS + ABS + ABS	BA2238 BA2235			23482 16,4 + ATE 23482 16,4 + ATE
<b>HONDA ACCORD (90-93)</b>								
	2.0 i 16V (CB3) 2.0 i 16V Coupe (CC1) 2.0 i Aero Deck (CC9) 2.2 i 16V (CB7) 2.2 i Aero Deck (CB8)		01.90 01.92 01.93 01.90 01.91	12.93 + ABS 12.93 12.93 12.93 12.93	BA2280			21719 15,0 +/WK AKE
<b>HONDA ACCORD (93-98)</b>								
	1.8 i (CC7) 1.8 i (CE7) 2.0 i (CC7) 2.0 i (CE8) 2.0 i Aero Deck (CE2) 2.0 i Coupe (CD9) 2.0 TDi (CF1) 2.2 i Aero Deck (CE1) 2.2 i Coupe (CD7) 2.2 i VTEC (CE9) 2.3 i (CC7)		01.94 01.96 01.93 01.96 01.94 01.94 01.96 01.94 01.94 01.96 01.93	12.95 09.98 12.95 09.98 01.98 01.98 09.98 01.98 01.98 09.98 12.95	BA2280			21719 15,0 +/WK AKE
<b>HONDA ACCORD (98-02)</b>								
	1.8 VTEC (CG8) 1.8 VTEC (CH6) 2.0 TDiC (CH2) 2.0 TDiC (CH8) 2.0 VTEC (CG9) 2.0 VTEC (CH7) 2.3 VTEC (CL3) 2.3 VTEC (CL4)	100 100 77 77 108 108 113 113	10.98 10.98 02.99 02.99 10.98 10.98 01.01 01.01	12.02 12.02 10.00 10.00 01.01 01.01 12.02 12.02	BA2278			23094 16,5 +/WK/S LUC
<b>HONDA ACCORD Coupe (98-03)</b>								
	2.0 i 16V (CG4) 2.0 i 16V (CG4) 3.0 i V6 (CG2) 3.0 VTEC (CG2)	107 108 147 152	11.99 02.98 02.98 10.01	10.02 06.03 06.03 06.03	BA2280			21719 15,0 +/WK AKE













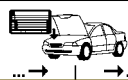











<sup>1)</sup> 260/280/300 series / Serie 260/280/300 / Série 260/280/300 / Serie 260/280/300

























<sup>2)</sup> 330/350 series / Serie 330/350 / Série 330/350 / Serie 330/350













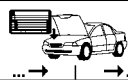



























								
<b>HONDA CITY (08-)</b>								
	1.4 i VTEC	73		09.08			BA2274	21697 15,0 +/WK
<b>HONDA CIVIC (3-türig) (91-95)</b>								
	1.5 16V (EG4) 1.6 16V VTEC (EG5)	92		09.91 09.91	10.95 10.95 - ABS		BA2274	21697 15,0 +/WK
	1.6 16V VTEC (EG5) 1.6 16V VTEC (EG6)	92 118		09.91 09.91	10.95 + ABS 10.95		BAR21105	262 21,0 19,0 V
<b>HONDA CIVIC (4-türig) (91-95)</b>								
	1.5 16V (EG8) 1.6 16V VTEC (EH9)	92		09.91 09.91	10.95 10.95 - ABS		BA2274	21697 15,0 +/WK
	1.6 16V 4WD VTEC(EH1) 1.6 16V VTEC (EG9) 1.6 16V VTEC (EH9)	92 118 92		09.91 09.91 09.91	10.95 10.95 10.95 + ABS		BAR21105	262 21,0 19,0 V
<b>HONDA CIVIC (3/4-türig) (95-01)</b>								
	1.4 i (EJ9) 1.4 i (EJ9)	55 66		11.95 11.95	01.01 - ABS 01.01 - ABS		BA2274	21697 15,0 +/WK
	1.4 i (EJ9) 1.4 i (EJ9) 1.5 VTEC (EK3) 1.6 VTEC (EK1) 1.6 VTEC (EK4)	55 66 84 83 118		11.95 11.95 11.95 11.95 11.95	10.98 + ABS 10.98 + ABS 01.01 01.01 01.01		BAR21105	262 21,0 19,0 V
<b>HONDA CIVIC (3-türig) (01-05)</b>								
	1.4 i 16V 1.6 i 16V	66 81		02.01 02.01	12.05 12.05		BA2010	21515 17,5 +/WK LUC
	1.4 i 16V 1.6 i 16V	66 81		02.01 02.01	12.05 12.05		BAR21105	262 21,0 19,0 V
	1.4 i 16V 1.6 i 16V 1.7 CTDi 2.0 Type R	66 81 74 147		02.01 02.01 01.02 09.01	12.05 12.05 12.05 12.05		BA2280	21719 15,0 +/WK AKE
<b>HONDA CIVIC (4-türig) (01-05)</b>								
	1.4 i 16V 1.6 i 16V	66 81		02.01 02.01	12.05 12.05		BAR21105	262 21,0 19,0 V
<b>HONDA CIVIC (5-türig) (94-96)</b>								
	1.4 i (MA8) 1.5 VTEC E (MA9) 1.6 i (MB1) 1.6 VTEC (MB1)			09.94 09.94 09.94 09.94	12.96 12.96 12.96 12.96		BA2010	21515 17,5 +/WK LUC
	1.4 i (MA8) 1.5 VTEC E (MA9) 1.6 i (MB1) 1.6 VTEC (MB1)			09.94 09.94 09.94 09.94	12.96 12.96 12.96 12.96		BAR21105	262 21,0 19,0 V
	1.4 i (MA8) 1.5 VTEC E (MA9)			01.96 01.96	12.96 - ABS 12.96 - ABS		BAW1911	Rz 19,05
<b>HONDA CIVIC (5-türig) (97-01)</b>								
	1.4 i 16V (MB2) 1.5 i 16V (MB3) 1.6 i 16V (MB4) 1.6 VTi 2.0 i TD (MB7)			01.97 01.97 01.97 01.97 01.97	02.01 02.01 02.01 02.01 02.01		BA2010	21515 17,5 +/WK LUC
	1.4 i 16V (MB2) 1.5 i 16V (MB3) 1.6 i 16V (MB4) 1.6 VTi 2.0 i TD (MB7)			01.97 01.97 01.97 01.97 01.97	02.01 02.01 02.01 02.01 02.01		BAR21105	262 21,0 19,0 V
	1.4 i 16V (MB2) 1.5 i 16V (MB3) 1.6 i 16V (MB4) 1.6 VTi 1.8 i 16V (MB6) 2.0 i TD (MB7)			01.99 01.99 01.99 01.99 01.97 01.99	02.01 + ABS 02.01 + ABS 02.01 02.01 02.01 02.01		BA2280	21719 15,0 +/WK AKE
<b>HONDA CIVIC (5-türig) (01-05)</b>								
	1.4 i 16V (EU7) 1.6 VTEC (EU8)	66 81		02.01 02.01	12.05 12.05		BAR21105	262 21,0 19,0 V





















	   kW							
<b>HONDA CIVIC (5-türig) (01-05)</b>								
	1.4 i 16V (EU7) 66 1.6 VTEC (EU8) 81 1.7 CTDi (EU9) 74 2.0 i Sport (EV1) 118		02.01 02.01 01.02 01.04	12.05 12.05 12.05 12.05	BA2280			21719 15,0 +/WK AKE
<b>HONDA CIVIC Hatchback (FK/FN) (05-)</b>								
	1.6 i 16V (FK4) 84		09.05		BA2280			21719 15,0 +/WK AKE
<b>HONDA CIVIC Stufenheck (FD) (05-)</b>								
	1.3 (FD3) 75 1.3 Hybrid (FD3) 70 1.6 16V (FD4) 92 1.6 16V (FD4/FD6) 84 1.8 16V (FD1) 97 1.8 16V (FD1) 103 1.8 i-Vtec (FD1/FD7) 103		02.06 01.06 09.05 09.05 01.06 02.06 09.05		BA2280			21719 15,0 +/WK AKE
<b>HONDA CIVIC AERODECK (98-01)</b>								
	1.4 i 16V (MB8) 55 1.4 i 16V (MB8) 66 1.5 VTEC (MB9) 84 1.6 i 16V (MC1) 85 2.0 TDiC (MC3) 77		02.98 02.98 02.98 02.98 02.98	02.01 02.01 02.01 02.01 02.01	BA2010			21515 17,5 +/WK LUC
	1.4 i 16V (MB8) 55 1.4 i 16V (MB8) 66 1.5 VTEC (MB9) 84 1.6 i 16V (MC1) 85 2.0 TDiC (MC3) 77		02.98 02.98 02.98 02.98 02.98	02.01 02.01 02.01 02.01 02.01	BAR21105			262 21,0 19,0 V
	1.5 VTEC (MB9) 84 1.6 i 16V (MC1) 85 1.8 VTEC (MC2) 124		02.98 02.98 02.98	02.01 + ABS 02.01 02.01	BA2280			21719 15,0 +/WK AKE
	1.4 i 16V (MB8) 55 1.4 i 16V (MB8) 66 1.5 VTEC (MB9) 84		02.98 02.98 02.98	02.01 - ABS 02.01 - ABS 02.01 - ABS	BAW1911			Rz 19,05
<b>HONDA CIVIC COUPE (94-95)</b>								
	1.5 i (EJ2) 74 1.6 i (EJ6) 77		01.94 01.94	12.95 12.95	BA2274			21697 15,0 +/WK
	1.6 VTEC (EJ1)		01.94	12.95	BAR21105			262 21,0 19,0 V
<b>HONDA CIVIC COUPE (96-01)</b>								
	1.6 i (EJ6) 77		01.96	01.01	BA2274			21697 15,0 +/WK
	1.6 VTEC (EJ8) 92 1.6 VTI VTEC (EM1) 118		01.96 04.99	01.01 01.01	BAR21105			262 21,0 19,0 V
<b>HONDA CIVIC COUPE (01-04)</b>								
	1.6 i 16V (EM6) 81 1.7 i 16V (EM2) 88 1.7 VTEC (EM2) 92		02.01 02.01 02.01	10.04 10.04 10.04	BAR21105			262 21,0 19,0 V
	1.6 i 16V (EM6) 81 1.7 i 16V (EM2) 88 1.7 VTEC (EM2) 92		02.01 02.01 02.01	10.04 10.04 10.04	BA2280			21719 15,0 +/WK AKE
<b>HONDA CONCERTO (90-95)</b>								
	1.5 i (HW) 82 1.6 i 16V (HW) 82 1.6 i 16V (HW) 90		01.90 01.90 01.90	01.95 01.95 01.95	BA2010			21515 17,5 +/WK LUC
<b>HONDA CRX (92-98)</b>								
	1.6 i 16V VTEC (EG2) 118 1.6 i 16V VTEC (EH6) 92		01.92 01.92	12.98 12.98	BAR21105			262 21,0 19,0 V
<b>HONDA INSIGHT (09-)</b>								
	1.3 Hybrid 65		04.09		BAR21105			262 21,0 19,0 V
	1.3 Hybrid 65		04.09		BA2280			21719 15,0 +/WK AKE
<b>HONDA INTEGRA R (97-01)</b>								
	1.8 Type R (DC2) 140		11.97	10.01	BA2280			21719 15,0 +/WK AKE

								
<b>HONDA JAZZ (02-08)</b>								
	1.2 (GD5)	57		03.02	10.08			
	1.2 (GE2)	59		10.05	10.08			
	1.4 (GD1)	61		03.02	10.08			
	1.4 (GE3)	65		04.05	10.08			
	1.4 (GE3)	67		09.05	10.08			
	1.7 (GD3)	92		01.04	10.08			
						BA2274		21697 15,0 +/WK
<b>HONDA JAZZ (08-)</b>								
	1.2 i-Vtec	66		07.08	12.08			
	1.4 iDSI (GE6)	73		07.08	12.08			
	1.5 iDSI (GE8)	88		07.08	12.08			
	1.2 i-Vtec	66		01.09				
						BA2274		21697 15,0 +/WK
						BAR21105		262 21,0 19,0 V
<b>HONDA LOGO (99-02)</b>								
	1.3 i	48		02.99	03.02			
						BA2274		21697 15,0 +/WK
<b>HONDA PRELUDE (92-96)</b>								
	2.0 i 16V (BB3)	98		01.92	12.96			
	2.2 i 16V VTEC (BB1)	136		01.93	12.96			
	2.3 i 16V (BB2)	118		01.92	12.96			
						BA2280		21719 15,0 +/WK AKE
<b>HONDA PRELUDE (96-00)</b>								
	2.0 i 16V (BB9)	98		10.96	10.00			
	2.2 i 16V	147		10.96	10.00			
	2.2 i 16V (BB6/BB8)	136		10.96	10.00			
						BA2280		21719 15,0 +/WK AKE
<b>HONDA S2000 (99-04)</b>								
	2.0 VTEC (AP1)	177		06.99	09.04			
						BA2280		21719 15,0 +/WK AKE
<b>HYUNDAI ACCENT I (94-99)</b>								
	1.3 i			10.94	12.99			
	1.3 i 12V	62		10.94	12.99			
	1.5 i 12V	65		10.94	12.99			
	1.5 i 16V	73		10.95	12.99			
	1.3 i			10.94	12.99			
	1.3 i 12V	62		10.94	12.99			
	1.5 i 12V	65		10.94	12.99			
	1.5 i 16V	73		10.95	12.99			
						BA2111		21012 15,0 AKE
						BAR19109		242 19,1 17,0 V
<b>HYUNDAI ACCENT II (00-05)</b>								
	1.3 i 12V	55		01.00	09.05			
	1.3 i 12V	61		01.00	09.05			
	1.3 i 12V	62		08.02	09.05			
	1.3 i 12V	63		01.00	07.02			
	1.5 CRDi	60		04.02	09.05			
	1.5 i 12V	66		01.00	10.02			
	1.5 i 16V	75		09.00	09.05			
	1.6 i 16V	77		10.02	09.05			
	1.3 i 12V	55		01.00	07.02			
	1.3 i 12V	61		01.00	07.02			
	1.3 i 12V	63		01.00	07.02			
	1.5 CRDi	60		04.02	07.02			
	1.5 i 12V	66		01.00	07.02			
	1.5 i 16V	75		09.00	07.02			
						BA2292		21012 15,0 +/WK AKE
<b>HYUNDAI ELANTRA (00-06)</b>								
	1.6 i 16V	66		11.01	05.06			
	1.6 i 16V	77		08.03	05.06			
	1.6 i 16V	79		11.01	05.06			
	1.6 i 16V	82		09.03	05.06			
	1.8 i 16V	79		11.01	07.03			
	1.8 i 16V	93		09.04	05.06			
	1.8 i 16V	97		11.01	05.06			
	2.0 CRDi	83		11.01	05.06			
	2.0 i 16V	102		11.01	05.06			
	2.0 i 16V	104		11.01	05.06			
	2.0 i 16V	105		10.03	05.06			
						BAW1911		Rz 19,05
						BAW1911	- ABS	Rz 19,05
<b>HYUNDAI ELANTRA (06-)</b>								
	1.6 CRDi	85		06.06				
	1.6 i 16V	90		06.06				
	2.0 CVT	105		06.06				
						BA2291		23543 15,7 +/WK AKE
<b>HYUNDAI GETZ (02-09)</b>								
	1.1 i 12V	46		09.02	07.05			
	1.1 i 12V	49		08.05	02.09			
	1.3 i 12V	60		09.02	04.05			
	1.3 i 12V	63		09.03	04.05			
	1.4 i 16V	71		08.05	02.09			
	1.5 CRDi	60		03.03	04.05			
						BA2292		21012 15,0 +/WK AKE

								
<b>HYUNDAI GETZ (02-09)</b>								
	1.5 CRDi 1.5 CRDi GLS 1.5 CRDi GLS 1.5 i GL 1.6 i 16V 1.6 i 16V	65 75 81 73 77 78		08.05 07.04 08.05 08.02 09.02 08.05	02.09 07.05 02.09 07.05 07.05 02.09		BA2292	21012 15,0 +/WK AKE
	1.5 CRDi 1.5 CRDi 1.5 CRDi GLS 1.5 CRDi GLS 1.6 i 16V 1.6 i 16V	60 65 75 81 77 78		03.03 08.05 07.04 08.05 09.02 08.05	04.05 + ABS 02.09 + ABS 07.05 + ABS 02.09 + ABS 07.05 + ABS 02.09 + ABS		BA2291	23543 15,7 +/WK AKE
<b>HYUNDAI GRANDEUR (99-05)</b>								
	2.5 i V6 3.0 i V6 3.0 i V6 3.5 i V6	120 138 153 145		06.99 09.99 10.01 10.02	05.05 10.02 05.05 05.05		BA2291	23543 15,7 +/WK AKE
<b>HYUNDAI GRANDEUR (05-)</b>								
	2.2 CRDi 2.2 CRDi 2.7 i V6 3.3 i V6	110 114 141 173		06.06 06.06 06.06 04.05			BA2291	23543 15,7 +/WK AKE
<b>HYUNDAI HIGHWAY VAN (00-04)</b>								
	2.0 CRDi 2.0 CVT 2.0 i 16V 2.7 i V6	83 103 100 125		04.01 11.03 03.00 03.00	03.04 03.04 03.04 03.04		BA2291	23543 15,7 +/WK AKE
<b>HYUNDAI LANTRA/ELANTRA (90-95)</b>								
	1.5			12.90	04.95		BA2111	21012 15,0 AKE
<b>HYUNDAI LANTRA/ELANTRA (95-00)</b>								
	1.5 12V			08.95	05.00 - ABS		BA2292	21012 15,0 +/WK AKE
<b>HYUNDAI LANTRA (00-03)</b>								
	1.6 i 16V 1.8 i 16V 2.0 CRDi 2.0 i 16V	79 97 83 104		11.01 11.01 11.01 11.01	07.03 - ABS 07.03 - ABS 07.03 - ABS 07.03 - ABS		BAW1911	Rz 19,05
<b>HYUNDAI MATRIX (01-08)</b>								
	1.5 CRDi 1.5 CRDi 1.5 CRDi VGT 1.6 i 16V 1.8 i 16V	60 75 81 76 90		10.01 12.04 08.05 06.01 06.01	02.05 + ABS 04.08 + ABS 04.08 + ABS 04.08 + ABS 04.08		BA2291	23543 15,7 +/WK AKE
	1.5 CRDi 1.5 CRDi 1.5 CRDi VGT 1.6 i 16V	60 75 81 76		10.01 12.04 08.05 06.01	02.05 - ABS 04.08 - ABS 04.08 - ABS 04.08 - ABS		BAW1911	Rz 19,05
<b>HYUNDAI PONY/EXCEL (89-94)</b>								
	1.3 1.5			08.89 08.89	06.94 06.94		BA2111	21012 15,0 AKE
	1.3 1.5			08.89 08.89	06.94 06.94		BAR19109	242 19,1 17,0 V
<b>HYUNDAI PONY/EXCEL (94-95)</b>								
	1.3 1.5			07.94 07.94	12.95 12.95		BA2111	21012 15,0 AKE
	1.3 1.5			07.94 07.94	12.95 12.95		BAR19109	242 19,1 17,0 V
<b>HYUNDAI S-COUPE (90-96)</b>								
	1.5 (G4EK)			06.92	04.96		BA2111	21012 15,0 AKE
	1.5 (G4DJ) 1.5 (G4EK)			03.90 06.92	05.92 04.96		BAR19109	242 19,1 17,0 V

		   kW																
<b>HYUNDAI SANTA FE (SM) (01-06)</b>																		
	2.0 CRDi	83		08.01	07.03	+ ABS		BA2291							23543	15,7	+WK	AKE
	2.0 CRDi	92		08.03	02.06	+ ABS												
	2.0 CRDi	107		11.03	02.06	+ ABS												
	2.0 CRDi 4x4	83		04.01	07.03	+ ABS												
	2.0 CRDi 4x4	92		08.03	02.06	+ ABS												
	2.0 CRDi 4x4	107		11.03	02.06	+ ABS												
	2.0 i 16V	99		02.01	02.06	+ ABS												
	2.2 CRDi	110		10.05	02.06	+ ABS												
	2.2 CRDi 4x4	110		10.05	02.06	+ ABS												
	2.4 i 16V	107		02.01	02.06	+ ABS												
	2.4 i 16V 4x4	107		02.01	02.06	+ ABS												
	2.7 i V6	139		10.05	02.06	+ ABS												
	2.7 i V6 4x4	127		02.01	02.06	+ ABS												
	2.7 i V6 4x4	139		10.05	02.06	+ ABS												
<b>HYUNDAI SANTAMO (98-02)</b>																		
	2.0 i	77		10.98	10.02	- ABS		BAR24136							256	24,0	21,5	V
	2.0 i 16V	102		02.99	10.02	- ABS												
	2.0 i 16V 4x4	100		10.98	10.02	- ABS												
	2.0 i 16V 4x4	102		02.99	10.02	- ABS												
	2.0 i	77		10.98	10.02	+ ABS		BAR24146							256	24,0	22,4	V
	2.0 i 16V	102		02.99	10.02	+ ABS												
	2.0 i 16V 4x4	100		10.98	10.02	+ ABS												
	2.0 i 16V 4x4	102		02.99	10.02	+ ABS												
<b>HYUNDAI SONATA (98-04)</b>																		
	2.0 i 16V	96		10.01	12.04	+ ABS		BA2291							23543	15,7	+WK	AKE
	2.0 i 16V	100		06.98	09.01	+ ABS												
	2.4 i 16V	105		03.98	09.01	+ ABS												
	2.5 i V6	118		06.98	09.01													
	2.7 i V6	127		10.01	12.04	+ ABS												
<b>HYUNDAI SONATA (05-)</b>																		
	2.0 CRDi	100		02.06				BA2291							23543	15,7	+WK	AKE
	2.0 CRDi	103		02.06														
	2.0 CRDi	105		02.06														
	2.0 VVTi	106		02.06														
	2.2 CRDi	110		02.06														
	2.4 VVTi	119		02.06														
	3.3 VVTi	171		02.06														
	3.3 VVTi	173		02.06														
<b>HYUNDAI TRAJET (00-08)</b>																		
	2.0 CRDi	83		04.01	07.08			BA2291							23543	15,7	+WK	AKE
	2.0 CRDi	92		08.05	07.08													
	2.0 CVVT	104		11.03	07.08													
	2.0 i 16V	100		03.00	10.03													
	2.0 i 16V	103		01.04	07.08													
	2.7 i V6	127		09.00	07.08													
<b>HYUNDAI TUCSON (04-)</b>																		
	2.0 CRDi	83		08.04	03.10			BA2291							23543	15,7	+WK	AKE
	2.0 CRDi	88		01.07	03.10													
	2.0 CRDi	100		01.06	03.10													
	2.0 CRDi	103		01.06	03.10													
	2.0 CRDi	110		01.09	03.10													
	2.0 CRDi Allrad	83		08.04	03.10													
	2.0 CRDi Allrad	88		01.07	03.10													
	2.0 CRDi Allrad	100		01.06	03.10													
	2.0 CRDi Allrad	103		01.06	03.10													
	2.0 CRDi Allrad	110		01.09	03.10													
	2.0 i 16V	104		08.04	03.10													
	2.0 i 16V Allrad	104		08.04	03.10													
	2.7 i 24V Allrad	129		08.04	03.10													
<b>HYUNDAI XG (98-05)</b>																		
	2.5 i V6 (XG25)	120		12.98	09.05			BA2291							23543	15,7	+WK	AKE
	2.7 i V6 (XG27)	118		10.03	09.05													
	3.0 i V6 (XG30)	138		12.98	09.05													
	3.5 i V6 (XG35)	145		04.03	09.05													
<b>HYUNDAI XG (05-)</b>																		
	2.7 i V6 (XG50)	141		05.06				BA2291							23543	15,7	+WK	AKE
	3.3 i V6 (XG50)	171		06.05														
<b>IVECO DAILY I / GRINTA (78-99)</b>																		
	35.10			01.96	04.99			BAV1054		2								Warnkontakt L=300mm
	35.12			01.96	04.99													
	49.12			01.96	04.99													
	35.10			01.96	04.99			BAV1054		2								Warnkontakt L=300mm
	35.12			01.96	04.99													
	49.12			01.96	04.99													
	60.12			01.96	04.99			BAV1054		2								Warnkontakt L=300mm
	65.12			01.96	04.99													

									
<b>IVECO DAILY II (99-06)</b>									
	35 35 S 49			05.99 05.99 05.99	04.06 04.06 04.06		BAV1054	2	Warnkontakt L=300mm
	35 35 S 49			05.99 05.99 05.99	04.06 04.06 04.06		BAV1054	2	Warnkontakt L=300mm
	60 C 15 65 C 15	107 107		05.99 05.99	04.06 04.06		BAV1054	2	Warnkontakt L=300mm
<b>JAGUAR S-Type (CCX) (99-08)</b>									
	4.2 V8 R 4.2 V8	219 291		04.02 04.02	04.08 04.08		BA2235		23482 16,4 + ATE
<b>JAGUAR X-Type (CF1) Limousine (01-)</b>									
	2.0 D 2.0 V6 2.2 D 2.2 D 2.2 D 2.5 V6 3.0 V6	96 115 107 110 114 144 169	J04730 J04730 J04730 J04730 J04730 J04730 J04730	07.03 03.02 01.07 10.05 10.05 06.01 06.01			BA2224		23279 18,5 /S BOS
	2.0 D 2.0 V6 2.2 D 2.2 D 2.2 D 2.5 V6 3.0 V6	96 115 107 110 114 144 169		07.03 03.02 01.07 10.05 10.05 06.01 06.01	10.05 10.05		BAR24161		300 24,0 22,0 V
	2.0 D 2.0 V6 2.2 D 2.2 D 2.2 D 2.5 V6 3.0 V6	96 115 107 110 114 144 169	E73993 E73993 E73993 E73993 E73993 E73993 E73993	07.03 03.02 01.07 10.05 10.05 06.01 06.01			BA2225		23557 17,2 /S BOS
	2.0 D 2.0 V6 2.2 D 2.2 D 2.2 D 2.5 V6 3.0 V6	96 115 107 E73994 110 E73994 114 E73994 144 E73994 169 E73994		07.03 03.02	10.05 10.05		BA2287		24260 16,9 /S BOS
	2.0 D 2.0 V6 2.2 D 2.2 D 2.2 D 2.5 V6 3.0 V6	96 115 107 110 114 144 169		07.03 03.02 01.07 10.05 10.05 06.01 06.01	10.05 10.05		BAR12154		280 12,0 10,0
<b>JAGUAR X-Type (CF1) Kombi (04-)</b>									
	2.0 D 2.0 V6 2.2 D 2.2 D 2.2 D 2.5 V6 3.0 V6	96 115 107 110 114 144 169	J04730 J04730 J04730 J04730 J04730 J04730 J04730	02.04 11.03 01.07 10.05 10.05 02.04 02.04			BA2224		23279 18,5 /S BOS
	2.0 D 2.0 V6 2.2 D 2.2 D 2.2 D 2.5 V6 3.0 V6	96 115 107 110 114 144 169		02.04 11.03 01.07 10.05 10.05 02.04 02.04	10.05		BAR24161		300 24,0 22,0 V
	2.0 D 2.0 V6 2.2 D 2.2 D 2.2 D 2.5 V6 3.0 V6	96 115 107 110 114 144 169	E73993 E73993 E73993 E73993 E73993 E73993 E73993	02.04 11.03 01.07 10.05 10.05 02.04 02.04			BA2225		23557 17,2 /S BOS
	2.0 D 2.0 V6 2.2 D 2.2 D 2.2 D 2.5 V6 3.0 V6	96 E73994 115 E73994 107 E73994 110 E73994 114 E73994 144 E73994 169 E73994			10.05		BA2287		24260 16,9 /S BOS
	2.0 D 2.0 V6 2.2 D 2.2 D 2.2 D 2.5 V6	96 115 107 110 114 144		02.04 11.03 01.07 10.05 10.05 02.04	10.05		BAR12154		280 12,0 10,0

								
<b>JAGUAR X-Type (CF1) Kombi (04-)</b>								
	3.0 V6	169		02.04		BAR12154		280 12,0 10,0
<b>JAGUAR XF (CC9) (08-)</b>								
	2.7 D	152		03.08		BA2235		23482 16,4 + ATE
	3.0 D	155	R47153	03.09				
	3.0 D	177	R47153	03.09				
	3.0 D	202	R47153	03.09				
	3.0 V6	175		03.08				
	4.2 V8	219		03.08				
	4.2 V8 Kompressor	306		03.08				
	5.0 V8	283	R47153	03.09				
	5.0 V8 Kompressor	375	B32752	03.09				
<b>JAGUAR XJ (X350,X358) (03-)</b>								
	XJ6 2.7 D	152 49701				BA2235		23482 16,4 + ATE
<b>JAGUAR XK Coupe (06-)</b>								
	5.0 XKR	375	B32752	01.09		BA2235		23482 16,4 + ATE
	5.0 XKR	390	B32752	09.10				
<b>JAGUAR XK Convertible (06-)</b>								
	5.0 XKR	375	B32752	01.09		BA2235		23482 16,4 + ATE
<b>KIA JOICE (00-03)</b>								
	2.0 i 16V	88		09.01	08.03 - ABS	BAR24136		256 24,0 21,5 V
	2.0 i 16V	102		01.00	08.03 - ABS			
	2.0 i 16V	88		09.01	08.03 + ABS	BAR24146		256 24,0 22,4 V
	2.0 i 16V	102		01.00	08.03 + ABS			
<b>KIA MAGENTIS (01-05)</b>								
	2.0 i 16V	100		05.01	10.05 + ABS	BA2291		23543 15,7 +/WK AKE
	2.5 i V6	124		05.01	10.05 + ABS			
<b>KIA MAGENTIS (05-)</b>								
	2.0 CRDi	100		11.05		BA2291		23543 15,7 +/WK AKE
	2.0 CRDi	103		04.06				
	2.0 CRDi	110		04.06				
	2.0 i 16V	106		11.05				
	2.0 i 16V	121		07.09				
	2.7 i V6	138		11.05				
	2.7 i V6	142		07.09				
<b>KIA RIO I (DC) (00-05)</b>								
	1.3 i	55		08.00	06.02	BA2115		21654 15,0 +/WK SUM
	1.3 i	60		08.00	06.02			
	1.5 i 16V	72		08.00	06.02			
<b>KIA SPORTAGE (04-10)</b>								
	2.0 CRDi	83		02.05	05.10	BA2291		23543 15,7 +/WK AKE
	2.0 CRDi	100		01.06	05.10			
	2.0 CRDi	103		01.06	05.10			
	2.0 CRDi	110		09.08	05.10			
	2.0 CRDi 4WD	83		09.04	05.10			
	2.0 CRDi 4WD	100		01.06	05.10			
	2.0 CRDi 4WD	103		01.06	05.10			
	2.0 CRDi 4WD	110		09.08	05.10			
	2.0 i 16V	104		09.04	05.10			
	2.0 i 16V 4WD	104		09.04	05.10			
	2.7 i V6 4WD	129		09.04	05.10			
<b>KIA VENGA (10-)</b>								
	1.4 CRDi 75	55		02.10		BA2194		23417 15,2 +/WK/S LUC
	1.4 CRDi 75	57		02.10				
	1.4 CRDi 90	66		02.10				
	1.4 CVT	66		02.10				
	1.6 CRDi 115	85		02.10				
	1.6 CRDi 128	94		02.10				
	1.6 CVT	92		02.10				
<b>LADA 110 Stufenheck (2110) (95-07)</b>								
	1.5	54		01.95	08.07	BA2040		21170 17,0 LUC
	1.5	57		01.95	08.07			
	1.5 i 16V	70		01.95	08.07			
	1.6	60		01.00				
	1.6	66		01.00				























<b>LADA 110 Stufenheck (2110) (95-07)</b>																				
	1.5	54	01.95	09.00	BAR12125														239 12,0 10,8	
	1.5	57	01.95	09.00																
	1.5 i 16V	70	01.95	09.00																
	1.6	60	01.00																	
	1.6	66	01.00																	
<b>LADA 111 Kombi (2111) (95-08)</b>																				
	1.5	57	01.95	12.08	BA2040														21170 17,0	LUC
	1.5 i 16V	70	01.95	12.08																
	1.6	60	01.05																	
	1.6	66	03.06																	
	1.5	57	01.95	09.00	BAR12125														239 12,0 10,8	
	1.5 i 16V	70	01.95	09.00																
<b>LADA 112 Fließheck (2112) (95-08)</b>																				
	1.5	54	01.95	12.08	BA2040														21170 17,0	LUC
	1.5	57	01.95	12.08																
	1.5 i 16V	70	01.95	12.08																
	1.6	60	01.05																	
	1.6	66	03.06																	
	1.5	54	01.95	09.00	BAR12125														239 12,0 10,8	
	1.5	57	01.95	09.00																
	1.5 i 16V	70	01.95	09.00																
<b>LADA FORMA (2108) (89-95)</b>																				
	1100		07.91	12.95	BA2040														21170 17,0	LUC
	1300		05.89	12.95																
	1500		07.91	12.95																
	1100		07.91	12.95	BAR12125														239 12,0 10,8	
	1300		05.89	12.95																
	1500		07.91	12.95																
<b>LADA KALINA (1117/1118/1119) (04-)</b>																				
	1.4 16V	66	11.08		BA2040														21170 17,0	LUC
	1.4 16V LPG	65	11.08																	
	1.6 i	60	10.04																	
	1.6 i 16V	66	10.04																	
<b>LADA PRIORA (2170/2172) (08-)</b>																				
	1.6 i 16V	72	11.08		BA2040														21170 17,0	LUC
	1.6 LPG	71	12.08																	
<b>LADA SAMARA (2108/2109) (86-99)</b>																				
	1100		09.88	12.99	BA2040														21170 17,0	LUC
	1300		07.86	12.99																
	1500		07.87	12.99																
	1100		09.88	12.99	BAR12125														239 12,0 10,8	
	1300		07.86	12.99																
	1500		07.87	12.99																
<b>LADA TOSCANA (2107) (83-96)</b>																				
	1300		09.85	12.96	BA2041														20166 16,0	LUC
	1500		09.83	02.93																
	1300		09.85	12.96	BAR11115														253 10,0 9,0	
	1500		09.83	02.93																
<b>LANCIA DEDRA (94-99)</b>																				
	1.6		11.93	08.99	BA2034														20833 17,1 +WK/S	LUC
	1.8 i.e.		11.93	08.99																
	2.0 i.e.		11.93	08.99																
	1.9 TD		11.93	08.99																
	1.6		11.93	08.99	BAR12127														257 12,0 10,2	
	1.9 TD	68	11.93	08.99																- Katalysator <sup>1)</sup>
	1.9 TD	66	11.93	08.99																+ Katalysator <sup>2)</sup>
	1.6		01.96	07.99																BAR22147
	1.8 i.e.		11.93	08.99																BAR20142
	1.8 i.e.		11.93	08.99	BAR22197														258 20,0 18,2 V L	
	2.0 i.e.		11.93	08.99																
	1.8 GT 16V		03.96	08.99																
	2.0 i.e. 16V		11.93	08.99	BAR2035														258 22,0 20,2 V	
	1.8 GT 16V		03.96	08.99																
	1.8 i.e.		11.93	08.99																
	1.9 TD		11.93	08.99																
	2.0 i.e.		11.93	08.99	BAR11119														21103 14,4 /S	LUC
	2.0 i.e. 16V		11.93	08.99																
	1.6		01.96	07.99																
	1.8 GT 16V		03.96	08.99																
	1.8 i.e.		11.93	08.99	BAR11119														240 11,0 9,2	
	1.8 i.e.		11.93	08.99																
	1.9 TD		11.93	08.99																
	2.0 i.e.		11.93	08.99																
	2.0 i.e. 16V		11.93	08.99																

<sup>1)</sup> - catalytic converter / - catalizzatore / - catalyseur / - catalizador























<sup>2)</sup> + catalytic converter / + catalizzatore / + catalyseur / + catalizador

<sup>3)</sup> + cast iron caliper / + pinza in ghisa / + étriers en fonte grise / + fundición gris-pinza





























								
<b>LANCIA DELTA (94-99)</b>								
	1.4 i.e.		11.93	08.99	BA2142			21930 17,9 +/WK ATE
	1.6 i.e.		11.93	08.99				
	1.6 i.e.	66	11.93	08.99	BA2143			21927 17,9 +/WK ATE
	1.8		02.96	09.99	BA2034			20833 17,1 +/WK/S LUC
	1.8 i.e.		11.93	08.99				
	2.0 TD		07.94	08.99				
	1.4 i.e.		11.93	08.99	BAR11119			240 11,0 9,2
	1.6 i.e.		11.93	08.99	BAR12127			257 12,0 10,2
	1.8	66	02.96	09.99				
	1.8 i.e.		11.93	08.99				
	2.0 TD		07.94	08.99				
	2.0 HF Turbo		11.93	08.99	BAR22147			284 22,0 20,2 V
	1.8	66	02.96	09.99	BA2035		+ GG-Sättel <sup>1)</sup>	21103 14,4 /S LUC
	1.8 i.e.		11.93	08.99				
	2.0 HF Turbo		11.93	08.99				
	2.0 i.e. 16V		11.93	08.99				
	2.0 TD		07.94	08.99				
	1.8	66	02.96	09.99	BAR11119			240 11,0 9,2
	1.8 i.e.		11.93	08.99				
	2.0 HF Turbo		11.93	08.99				
	2.0 i.e. 16V		11.93	08.99				
	2.0 TD		07.94	08.99				
<b>LANCIA DELTA (08-)</b>								
	1.4 16V	88	08.08		BA2299			23709 19,4 +/WK/S BOS
	1.4 Bifuel	88	07.11					
	1.6 D Multijet	77	04.11					
	1.6 D Multijet	88	08.08					
	1.4 16V	88	08.08		BAR22147			284 22,0 20,2 V
	1.4 Bifuel	88	07.11					
	1.6 D Multijet	77	04.11					
	1.6 D Multijet	88	08.08					
	1.4 16V	88	08.08		BA2303			23714 16,3 /S BOS
	1.4 16V	103	07.10					
	1.4 16V Turbo	110	08.08					
	1.4 Bifuel	88	07.11					
	1.6 D Multijet	77	04.11					
	1.6 D Multijet	88	08.08					
	1.8 Di 16V	147	01.09					
	1.9 D Multijet	140	08.08					
	2.0 D Multijet	121	08.08					
<b>LANCIA LYBRA (99-05)</b>								
	1.8 i 16V		04.00	12.05	BA2315			23289 19,3 +/WK ATE
	1.9 JTD		04.00	12.05				
	2.0 i 20V		04.00	12.05				
	2.4 JTD		04.00	12.05				
	1.6		10.00	10.05	BAR22147			284 22,0 20,2 V
	1.8 i 16V		10.99	12.05				
	1.9 JTD		10.99	12.05				
	2.0 i 20V		10.99	12.05				
	2.4 JTD		10.99	12.05				
	1.6		10.00	10.05	BA2271			23517 16,3 /S LUC
	1.6 i 16V		10.99	12.05				
	1.8 i 16V		10.99	12.05				
	1.9 JTD		10.99	12.05				
	2.0 i 20V		10.99	12.05				
	2.4 JTD		10.99	12.05				
<b>LANCIA MUSA (04-)</b>								
	1.3 D Multijet	51	10.04		BA2289			23708 18,4 /S BOS
	1.3 D Multijet	66	09.06					
	1.3 D Multijet	70	08.09					
	1.6 D Multijet	85	07.08					
	1.6 D Multijet	88	06.08					
	1.9 D Multijet	74	10.04					
	1.4	57	07.05		BAR22197			258 22,0 20,2 V
	1.4	66	10.07					
	1.4	70	10.04					
	1.4 LPG	57	11.10					
	1.3 D Multijet	51	10.04		BAR22147			284 22,0 20,2 V
	1.3 D Multijet	66	09.06					
	1.3 D Multijet	70	08.09					
	1.6 D Multijet	85	07.08					
	1.6 D Multijet	88	06.08					
	1.9 D Multijet	74	10.04					
	1.6 D Multijet	85	07.08		BAR11119			240 11,0 9,2
	1.6 D Multijet	88	06.08					
	1.9 D Multijet	74	10.04	06.05	BAW2003			Rz 20,64 AP

<sup>1)</sup> + cast iron caliper / + pinza in ghisa / + étriers en fonte grise / + fundición gris-pinza

								
<b>LANCIA PHEDRA (02-10)</b>								
	2.0 i 16V 2.0 JTD 2.0 JTD 2.2 JTD	100 80 100 94		08.02 08.02 03.08 08.02	09.10 09.10 09.10 09.10		BA2285	20261 19,3 +/WK/S LUC
	2.0 i 16V 2.0 JTD 2.0 JTD 2.2 JTD	100 80 100 94		08.02 08.02 03.08 08.02	09.10 09.10 09.10 09.10		BAR28136	285 28,0 26,0 V
	2.0 i 16V 2.0 JTD 2.0 JTD 2.2 D Multijet 2.2 JTD 2.2 JTD 3.0 i V6	100 80 100 125 94 125 150		08.02 08.02 03.08 03.08 08.02 03.08 08.02	09.10 09.10 09.10 09.10 09.10 09.10 09.10		BA2017	20961 17,2 /S LUC
<b>LANCIA THEMA (92-94)</b>								
	2.0 i.e. 16V Turbo 3.0 i.e. V6			10.92 10.92	12.94 12.94	- gepanzerte Fahrzeuge <sup>1)</sup> - gepanzerte Fahrzeuge <sup>1)</sup>	BAR22147	284 22,0 20,2 V
<b>LANCIA Y 10 (85-95)</b>								
	1.0 1.0 i.e. 1.1 i.e.			06.85 12.87 01.90	12.89 12.89 12.95		BA2065	20775 18,0 /WK BDX
	1.0 1.0 i.e. 1.1 i.e. 1.1 Turbo 1.3 GT i.e.			06.85 12.87 01.90 06.85 02.89	12.89 12.89 12.95 12.89 12.95		BAW1902	Rz 19,05
<b>LANCIA Y (96-03)</b>								
	1.1 i 1.2 i 1.2 i 1.2 i 1.2 i 16V 1.2 i 16V 1.4 i			05.97 01.96 10.00 10.00 10.00 05.97 01.96	12.98 09.00 07.03 07.03 07.03 09.00 12.98		BA2072 BA2073 BA2332 BA2034	21436 17,0 BDX 21436 17,0 /WK BDX 23181 17,9 + ATE 20833 17,1 +/WK/S LUC
	1.1 i 1.2 i 1.2 i 1.2 i 1.2 i 16V 1.2 i 16V 1.4 i			05.97 01.96 10.00 10.00 05.97 01.96	12.98 09.00 07.03 07.03 09.00 12.98		BAR11119 BAR12127	240 11,0 9,2 257 12,0 10,2
	1.1 i 1.2 i 1.2 i 16V 1.2 i 16V 1.4 i			05.97 01.96 10.00 05.97 01.96	12.98 07.03 07.03 09.00 12.98		BAW2009 BAW2003	Rz 20,64 BDX Rz 20,64 AP
	1.1 i 1.2 i 1.2 i 16V 1.2 i 16V 1.4 i			05.97 01.96 10.00 05.97 01.96	12.98 07.03 07.03 09.00 12.98		BAE5016	180 x 32 HEB AUT AP
<b>LANCIA YPSILON (03-11)</b>								
	1.2 i 1.4 i 1.2 i 16V 1.3 JTD 1.3 JTD 1.3 JTD 1.3 JTD 1.4 i 16V	44 57 59 51 55 66 77 70		06.03 02.06 06.03 06.03 10.06 10.06 07.07 06.03	06.11 06.11 06.11 06.11 06.11 06.11 06.11 06.11		BAR12127 BAR22197	257 12,0 10,2 258 22,0 20,2 V
<b>LANCIA YPSILON (11-)</b>								
	0.9 TwinAir Turbo 1.3 D Multijet 1.2 1.2 Bifuel	63 70 51 49		07.11 07.11 07.11 07.11			BAR22197 BAR12127	258 22,0 20,2 V 257 12,0 10,2
<b>LANCIA ZETA (94-02)</b>								
	2.0 i.e. 16V 2.0 i.e. Turbo 2.0 JTD 2.1 TD			05.98 06.94 09.99 06.96	09.02 09.02 09.02 09.99		BA2047	21801 19,0 +/WK/S LUC
	2.0 i.e. 16V 2.0 i.e. Turbo 2.0 JTD 2.1 TD			05.98 06.94 09.99 06.96	09.02 09.02 09.02 09.99		BAR26104	281 26,0 24,2 V

























<sup>1)</sup> - armoured vehicles / - veicoli blindati / - véhicule blindé / - vehículo blindado

								
<b>LANCIA ZETA (94-02)</b>								
	2.0 i.e. 16V 2.0 JTD		05.98 09.99	09.02 09.02	- ABS - ABS	BAW1906		Rz 19,05
	2.0 i.e. 16V 2.0 JTD		05.98 09.99	09.02 09.02	- ABS - ABS	BAE5037		255 x 61
<b>LAND ROVER DISCOVERY I (89-98)</b>								
	2.0 16V 2.5 TDI 3.5 V8 3.9/4.0 V8	99 (V)MA081992 83 (V)MA081992 113 (V)MA081992 134 (V)MA081992		06.94 12.98 03.94 12.98		BA2187		21459 18,5 +/WK AP
<b>LAND ROVER DISCOVERY II (94-04)</b>								
	2.0 16V	99	01.94	11.98		BA2187		21459 18,5 +/WK AP
<b>LAND ROVER DISCOVERY III (04-09)</b>								
	2.7 TD 4.0 4x4 4.0 4x4 4.0 V6 4x4 4.4	140 160 161 156 220	07.04 02.05 02.05 10.04 07.04	08.09 08.09 08.09 08.09 08.09	- gepanzerte Fahrzeuge <sup>1)</sup> - gepanzerte Fahrzeuge <sup>1)</sup> - gepanzerte Fahrzeuge <sup>1)</sup> - gepanzerte Fahrzeuge <sup>1)</sup> - gepanzerte Fahrzeuge <sup>1)</sup>	BAV1055	1	Warnkontakt L=1178mm
	2.7 TD 4.0 4x4 4.0 4x4 4.0 V6 4x4 4.4	140 160 161 156 220	07.04 02.05 02.05 10.04 07.04	08.09 08.09 08.09 08.09 08.09	- gepanzerte Fahrzeuge <sup>1)</sup> - gepanzerte Fahrzeuge <sup>1)</sup> - gepanzerte Fahrzeuge <sup>1)</sup> - gepanzerte Fahrzeuge <sup>1)</sup> - gepanzerte Fahrzeuge <sup>1)</sup>	BAV1056	1	Warnkontakt L=1184mm
<b>LAND ROVER FREELANDER (LN) (98-06)</b>								
	1.8 i 16V 1.8 i 16V 2.0 DI 2.0 TD4 2.0 TD4 2.5 V6	86 88 72 80 82 130	YA999999 YA999999 YA999999 YA999999 YA999999	11.00 02.98 02.98 11.01 11.00 11.00		BAW2007		Rz 20,64
<b>LAND ROVER FREELANDER 2 (FA) (07-)</b>								
	2.2 SD4 2.2 TD4 2.2 TD4 2.2 TD4 2.2 TD4 4x4 2.2 TD4 4x4 3.2 3.2 i6 HSE 4x4	140 110 112 118 110 115 171 170		08.10 08.10 01.07 10.06 10.06 10.06 01.07 10.06		BA2314		24123 20,2 + ATE
<b>LAND ROVER RANGE ROVER III (LM) (02-)</b>								
	3.0 TD 6 3.6 TD 8 4.2 4.4 4.4	130 200 291 210 225	5A999999 5A999999 5A999999 5A999999 5A999999	03.02 04.06 05.05 03.02 05.05	- gepanzerte Fahrzeuge <sup>1)</sup> - gepanzerte Fahrzeuge <sup>1)</sup> - gepanzerte Fahrzeuge <sup>1)</sup> - gepanzerte Fahrzeuge <sup>1)</sup> - gepanzerte Fahrzeuge <sup>1)</sup>	BA2167		21487 17,3 +/WE ATE
<b>LAND ROVER RANGE ROVER SPORT (LS) (05-)</b>								
	2.7 TD V6 4.4 V8	140 220		02.05 02.05		BAV1055	1	Warnkontakt L=1178mm
	2.7 TD V6 3.6 TD V8 4.2 V8 4.2 V8 4.4 V8	140 200 287 291 220		02.05 04.06 02.05 11.09 02.05		BAV1056	2	Warnkontakt L=1184mm
<b>MAZDA 121 (91-96)</b>								
	1.3 16V (DB1)			04.91	02.96	BA2115		21654 15,0 +/WK SUM
	1.3 16V (DB1)			04.91	02.96 + Automatikgetriebe <sup>2)</sup>	BAR18113		235 18,0 16,0 V
<b>MAZDA 121 (96-03)</b>								
	1.2 i 16V 1.3 i 1.8 D	55 44 44		03.96 03.96 03.96	01.00 + Schaltgetriebe <sup>3)</sup> 01.00 01.00	BA2146		21202 17,0 + ATE
	1.2 i 16V 1.2 i 16V 1.3 i 1.8 D	55 55 44 44		03.96 02.00 02.00 02.00	01.00 + Automatikgetriebe <sup>2)</sup> 03.03 03.03 03.03	BA2144 BA2203 BA2199	- ABS + ABS	20640 18,0 + ATE 23200 18,8 + ATE 23604 18,8 + ATE
	1.2 i 16V 1.3 i 1.8 D	55 44 44		03.96 03.96 03.96	01.00 + Schaltgetriebe <sup>3)</sup> 01.00 01.00	BAR12141		239 12,0 10,0
	1.2 i 16V	55		03.96	01.00 + Automatikgetriebe <sup>2)</sup>	BAR20147		240 20,0 18,0 V

<sup>1)</sup> - armoured vehicles / - veicoli blindati / - véhicule blindé / - vehiculo blindado

<sup>2)</sup> + autom.transmission / + scatola cambio automatico / + transmission automatique / + cambio automático

<sup>3)</sup> + manual transmission / + scatola cambio velocità / + transmission mécanique / + cambio de velocidad

								
<b>MAZDA 121 (96-03)</b>								
	1.2 i 16V 1.3 i 1.8 D	55 44	02.00 02.00 02.00	03.03 03.03 03.03	BAR20147 BAR22172		- ABS + ABS	240 20,0 18,0 V 258 22,0 20,0 V
	1.2 i 16V 1.3 i 1.8 D	55 44	03.96 03.96 03.96	01.00 01.00 01.00	BAW1702		nur paarweise austauschen <sup>2)</sup>	Rz 17,78 <b>LUC</b>
	1.2 i 16V 1.3 i 1.8 D	55 44	02.00 02.00 02.00	03.03 03.03 03.03	BAW1914			Rz 19,05
	1.2 i 16V 1.3 i 1.8 D	55 44	03.96 03.96 03.96	03.03 03.03 03.03	BAW1901		nur paarweise austauschen <sup>2)</sup>	Rz 19,05 <b>LUC</b>
	1.2 i 16V 1.3 i 1.8 D	55 44	03.96 03.96 03.96	01.00 01.00 01.00	BAE5004			180 x 32 HEB <b>LUC</b>
	1.2 i 16V 1.3 i 1.8 D	55 44	02.00 02.00 02.00	03.03 03.03 03.03	BAE5039 BAE5036		- ABS + ABS	180 x 32 HEB 203 x 38 HEB <b>AP</b>
<b>MAZDA 2 (03-07)</b>								
	1.2 i 16V 1.3 i 16V 1.4 CD 1.4 i 16V 1.6 i 16V	55 67 50 59 74	04.03 04.03 04.03 02.03 02.03	09.07 09.07 09.07 09.07 09.07	BA2199			23604 18,8 + <b>ATE</b>
	1.2 i 16V 1.3 i 16V 1.4 CD 1.4 i 16V 1.6 i 16V	55 67 50 59 74	04.03 04.03 04.03 02.03 02.03	09.07 09.07 09.07 09.07 09.07	BAR22172			258 22,0 20,0 V
	1.2 i 16V 1.3 i 16V 1.4 CD 1.4 i 16V 1.6 i 16V	55 67 50 59 74	04.03 04.03 04.03 02.03 02.03	09.07 09.07 09.07 09.07 09.07	BAW1914			Rz 19,05
	1.2 i 16V 1.3 i 16V 1.4 CD 1.4 i 16V 1.6 i 16V	55 67 50 59 74	04.03 04.03 04.03 02.03 02.03	09.07 09.07 09.07 09.07 09.07	BAE5036			203 x 38 HEB
<b>MAZDA 3 (03-09)</b>								
	1.4 i 16V 1.4 i 16V 1.6 CiTD 1.6 i 16V 2.0 i 16V 2.0 MZR-CD 2.3 i 16V 2.3 i 16V Sport	59 62 80 77 110 105 118 126	10.03 10.03 06.04 10.03 10.03 12.06 10.03 10.03	05.09 03.06 05.09 05.09 05.09 05.09 09.04 05.09	BA2234			23723 18,4 + <b>ATE</b>
	1.4 i 16V 1.4 i 16V 1.6 CiTD 1.6 i 16V 2.0 i 16V 2.0 MZR-CD 2.3 i 16V 2.3 i 16V Sport 2.3 MPS	59 62 80 77 110 105 118 126 191	10.03 10.03 06.04 10.03 10.03 12.06 10.03 10.03 12.06	05.09 03.06 05.09 05.09 05.09 05.09 09.04 05.09 05.09	BA2258			23482 16,4 + <b>ATE</b>
<b>MAZDA 3 (09-)</b>								
	1.6 MZR 1.6 MZR-CD 1.6 MZR-CD 2.0 MZR 2.0 MZR DISI 2.2 MZR-CD 2.2 MZR-CD	77 80 85 110 111 110 136	06.09 06.09 11.10 06.09 06.09 06.09 06.09		BA2234			23723 18,4 + <b>ATE</b>
	1.6 MZR 1.6 MZR-CD 1.6 MZR-CD 2.0 MZR 2.0 MZR DISI 2.2 MZR-CD 2.2 MZR-CD 2.3 MPS Turbo	77 80 85 110 111 110 136 191	06.09 06.09 11.10 06.09 06.09 06.09 06.09 06.09		BA2258			23482 16,4 + <b>ATE</b>
<b>MAZDA 323 Limousine/323 F (89-94)</b>								
	1.3 i (BG) 1.6 i (BG) 1.7 D (BG) 1.8 i 16V (BG) 1.8 i 16V 4WD (BG)		09.89 09.89 09.89 09.89 09.89	12.94 12.94 12.94 12.94 + OHC 12.94	BA2115			21654 15,0 +/-WK <b>SUM</b>
	1.3 i (BG) 1.6 i (BG) 1.7 D (BG) 1.8 i 16V (BG)		09.89 09.89 09.89 09.89	12.94 + Schaltgetriebe <sup>1)</sup> 12.94 + HA-Trommelbr./+Schaltgetriebe <sup>4)</sup> 12.94 + Schaltgetriebe <sup>1)</sup> 12.94 + OHC/+HA-Trommelbr./+Schaltg. <sup>5)</sup>	BAR18113			235 18,0 16,0 V

<sup>1)</sup> + manual transmission / + scatola cambio velocità / + transmission mécanique / + cambio de velocidad

<sup>2)</sup> to change only by pairs / sostituire solo a coppie / à changer seulement par paires / cambiar solamente por parejas





















<sup>3)</sup> + autom.transmission / + scatola cambio automatico / + transmission automatique / + cambio automático

<sup>4)</sup> + RA drum brake/+ manual transm. / + P fr.a tamburo/+ scatola camb.velocità / + fr.à tambour ess.AR/ + transm.

























mécán. / + ET-tamb.de freno/ + camb.de velocidad

<sup>5)</sup> + OHC/+RA drum br./+manual transm. / + OHC/+P fr.a tamb./+scatola camb.veloc. / + OHC/+fr.tamb.ess.AR/+





























transm.mécán. / + OHC/ + ET-tamb.fr./ + camb.velocidad

								
<b>MAZDA 323 Limousine/323 F (89-94)</b>								
	1.3 i (BG) 1.6 i (BG) 1.6 i (BG) 1.8 i 16V (BG) 1.8 i 16V (BG)		09.89 09.89 09.89 09.89 09.89	12.94 + Automatikgetriebe <sup>1)</sup> 12.94 + Automatikgetriebe <sup>1)</sup> 12.94 + HA-Scheibenbr./ +Schaltgetr. <sup>2)</sup> 12.94 + Automatikgetriebe <sup>1)</sup> 12.94 + OHC/+HA-Scheibenbr./+Schaltg. <sup>3)</sup>	BAR22166			235 22,0 20,0 V
	1.3 i (BG) 1.6 i (BG) 1.7 D (BG) 1.8 i 16V (BG)		05.91 05.91 05.91 05.91	12.94 12.94 12.94 12.94	BAE5027			200 x 36
<b>MAZDA 323 Limousine/323 C/323 F/323 S (94-98)</b>								
	1.3 i 16V (BA1) 1.5 i 16V (BA1) 1.8 i (BA1)		05.94 05.94 05.94	08.98 08.98 08.98 + 5 türieg <sup>4)</sup>	BA2115			21654 15,0 +/-WK SUM
	1.3 i 16V (BA1) 1.5 i 16V (BA1)		05.94 05.94	08.98 08.98	BAR18113 BAR22166			235 18,0 16,0 V 235 22,0 20,0 V
	1.3 i 16V (BA1) 1.5 i 16V (BA1) 1.7 D (BA1) 1.8 i (BA1) 2.0 D		05.94 05.94 05.94 05.94 10.96	08.98 08.98 08.98 08.98 08.98	BAE5027			200 x 36
<b>MAZDA 323 Limousine/323 F/323 P/323 S (98-03)</b>								
	1.6 i 16V (BJ) 70 1.6 i 16V (BJ) 72 1.8 i 16V (BJ) 84 2.0 D (BJ) 52 2.0 DiTD (BJ) 74 2.0 i 16V (BJ) 96 2.0 TD (BJ) 66		01.01 01.01 08.98 08.98 01.01 01.01 08.98	10.03 10.03 12.00 12.00 10.03 10.03 12.00	BA2118			21754 15,8 +/-WK SUM
	1.6 i 16V (BJ) 70 1.6 i 16V (BJ) 72 1.8 i 16V (BJ) 84 2.0 D (BJ) 52 2.0 DiTD (BJ) 74 2.0 i 16V (BJ) 96 2.0 TD (BJ) 66		01.01 01.01 08.98 08.98 01.01 01.01 08.98	10.03 10.03 12.00 12.00 10.03 10.03 12.00 - Sportfahrwerk <sup>5)</sup>	BAR24164			258 23,9 22,0 V
	1.6 i 16V (BJ) 70 1.6 i 16V (BJ) 72 1.8 i 16V (BJ) 84 2.0 D (BJ) 52 2.0 DiTD (BJ) 74 2.0 i 16V (BJ) 96 2.0 TD (BJ) 66		01.01 01.01 08.98 08.98 01.01 01.01 08.98	10.03 10.03 12.00 12.00 10.03 10.03 12.00	BA2257			24045 13,1 AKE
<b>MAZDA 5 (05-)</b>								
	1.6 CD 85 1.8 i 16V 85 1.8 i 16V 85 2.0 16V 110 2.0 CiTD 81 2.0 CiTD 105 2.0 i 16V 107		09.10 03.05 09.10 09.10 03.05 06.05 03.05		BA2234			23723 18,4 + ATE
	1.6 CD 85 1.8 i 16V 85 1.8 i 16V 85 2.0 16V 110 2.0 CiTD 81 2.0 CiTD 105 2.0 i 16V 107		09.10 03.05 09.10 09.10 03.05 06.05 03.05		BA2258			23482 16,4 + ATE
<b>MAZDA 6 Limousine (GG) (02-07)</b>								
	1.8 16V 88 2.0 16V 104 2.0 16V 108 2.0 DI 89 2.0 DI 100 2.0 DI 105 2.3 16V 118 2.3 16V 120 2.3 16V 122		08.02 06.02 03.05 08.02 06.02 06.05 07.03 03.05 06.02	07.07 07.07 07.07 07.07 07.07 07.07 02.05 07.07 07.07	BA2257			24045 13,1 AKE
<b>MAZDA 6 Kombi (GY) (02-07)</b>								
	1.8 16V 88 2.0 16V 104 2.0 16V 108 2.0 CiTD 4x4 89 2.0 CiTD 4x4 100 2.0 DI 89 2.0 DI 100 2.0 DI 105 2.3 16V 122 2.3 16V AWD 119		08.02 08.02 03.05 10.02 10.02 08.02 08.02 06.05 08.02 11.02	07.07 07.07 07.07 02.05 02.05 07.07 07.07 07.07 07.07 07.07	BA2257			24045 13,1 AKE

<sup>1)</sup> + autom.transmission / + scatola cambio automatico / + transmission automatique / + cambio automático  
<sup>2)</sup> + RA disc brake/+ manual transm. / + P disco freno/+ scatola camb.velocità / + fr.à disque ess.AR/ + transm. mécanique / + ET disco de freno/ + camb.velocidad  
<sup>3)</sup> + OHC/+RA disc br./+manual transm. / + OHC/+P disco fr. /+ scat.camb.velocità / + OHC/+fr.disco.ess.AR/+ transm.mécan. / + OHC/ + ET-disco fr./ + camb.velocidad  
<sup>4)</sup> + 5 door / + 5 porte / + 5 portes / + 5 puertas  
<sup>5)</sup> - sports suspension / - sospensione sportiva / - châssis de sport / - suspensión deportiva





















        												
<b>MAZDA 6 (07-)</b>												
	1.8 MZR	88		08.07					BA2257		24045 13,1	AKE
	2.0 MZR	108		08.07								
	2.0 MZR-CD	103		08.07								
	2.2 MZR-CD	92		01.09								
	2.2 MZR-CD	120		01.09								
	2.2 MZR-CD	136		01.09								
	2.5 MZR	125		08.07								
<b>MAZDA 626 (91-97)</b>												
	1.8 i (GE1)			09.91	04.97				BA2118		21754 15,8 +/-WK	SUM
	2.0 D (GE1)			09.91	04.97							
	2.0 i (GE1)			09.91	04.97							
	2.0 i 4WD (GE8)			09.91	04.97							
	2.5 i V6 (GE1/GE7)			09.91	04.97							
	1.8 i (GE1)			09.91	04.97				BAR24129		258 24,0 22,0 V	
	2.0 D (GE1)			09.91	04.97							
	2.0 i (GE1)			09.91	04.97							
	2.0 i 4WD (GE8)			09.91	04.97							
	2.5 i V6 (GE1/GE7)			09.91	04.97							
<b>MAZDA 626 (97-02)</b>												
	1.8 i 16V (GF)	66		05.97	11.99				BA2118	+ 14" Rad <sup>1)</sup>	21754 15,8 +/-WK	SUM
	1.8 i 16V (GF)	74		12.99	04.02							
	2.0 DiTD (GF)			04.98	04.02							
	2.0 i 16V (GF)	85		05.97	04.02							
	2.0 i 16V (GF)	100		02.98	04.02							
	1.8 i 16V (GF)	66		05.97	11.99				BAR24129		258 24,0 22,0 V	
	1.8 i 16V (GF)	74		12.99	04.02							
	2.0 DiTD (GF)			04.98	04.02							
	2.0 i 16V (GF)	85		05.97	04.02							
	2.0 i 16V (GF)	100		02.98	04.02							
	2.0 DiTD (GF)			04.98	04.02				BA2257		24045 13,1	AKE
	2.0 i 16V (GF)	85		05.97	04.02							
	2.0 i 16V (GF)	100		02.98	04.02							
<b>MAZDA 626 Kombi (88-92)</b>												
	1.8 (GV1)	72		03.88	02.92				BA2110		21378 15,0 +/-WK	AKE
	2.0 (GV1)			03.88	02.92							
	2.0 D (GV1)	44		03.88	07.91							
	2.2 12V (GV1)	85		03.88	10.90							
	2.2 12V 4WD (GV8)	85		03.92	11.92							
<b>MAZDA 626 Kombi (92-98)</b>												
	2.0 D (GV1)	55		04.92	01.98				BA2110		21378 15,0 +/-WK	AKE
	2.0 D (GV1)	60		11.94	04.96							
	2.0 i (GV1)	66		04.92	01.98							
	2.0 i 16V (GV1)	86		04.92	02.95							
	2.2 i 12V (GV1)	85		04.92	01.98							
	2.2 i 12V 4WD (GV1)	85		04.92	01.98							
<b>MAZDA 626 Kombi (98-02)</b>												
	1.8 i 16V (GW)	66		02.98	12.99				BA2118		21754 15,8 +/-WK	SUM
	2.0 DiTD (GW)	74		04.98	09.99							
	2.0 i 16V (GW)	85		02.98	09.99							
	2.0 i 16V (GW)	100		02.98	09.99							
	1.8 i 16V (GW)	66		02.98	12.99				BAR24129		258 24,0 22,0 V	
	1.8 i 16V (GW)	74		01.00	06.02							
	2.0 i 16V (GW)	85		02.98	06.02							
	2.0 i 16V (GW)	100		02.98	06.02							
	1.8 i 16V (GW)	66		02.98	12.99				BA2257		24045 13,1	AKE
	1.8 i 16V (GW)	74		01.00	06.02							
	2.0 DiTD (GW)	74		04.98	06.02							
	2.0 DiTD (GW)	81		10.00	06.02							
	2.0 i 16V (GW)	85		02.98	06.02							
	2.0 i 16V (GW)	100		02.98	06.02							
<b>MAZDA DEMIO (98-02)</b>												
	1.3 i 16V	46		08.98	10.02				BA2115		21654 15,0 +/-WK	SUM
	1.3 i 16V	53		08.98	03.00							
	1.5 i 16V	55		04.00	10.02							
	1.3 i 16V	46		08.98	10.02				BAR22166		235 22,0 20,0 V	
	1.3 i 16V	53		08.98	03.00							
	1.5 i 16V	55		04.00	10.02							
<b>MAZDA DEMIO (03-)</b>												
	1.2 i 16V	55		04.03					BA2199		23604 18,8 +	ATE
	1.4 CD	50		04.03								
	1.4 i 16V	58		02.03								
	1.6 i 16V	74		02.03								
	1.2 i 16V	55		04.03					BAR22172		258 22,0 20,0 V	
	1.4 CD	50		04.03								
	1.4 i 16V	58		02.03								
	1.6 i 16V	74		02.03								

<sup>1)</sup> + 14" wheel / + ruota 14" / + roue 14" / + rueda 14"

								
<b>MAZDA DEMIO (03-)</b>								
	1.2 i 16V 1.4 CD 1.4 i 16V 1.6 i 16V	55 50 58 74	04.03 04.03 02.03 02.03		BAW1914			Rz 19,05
	1.2 i 16V 1.4 CD 1.4 i 16V 1.6 i 16V	55 50 58 74	04.03 04.03 02.03 02.03		BAE5036			203 x 38 HEB
<b>MAZDA MX-3 (91-98)</b>								
	1.6 i (EC)		07.91	12.98 - ABS	BAE5027			200 x 36
<b>MAZDA MX-5 (89-98)</b>								
	1.6 i (NA1) 1.6 i (NA1)	66 85	01.95 08.89	04.98 - ABS 08.93 - ABS	BAR18113			235 18,0 16,0 V
<b>MAZDA MX-6 (91-97)</b>								
	2.0 i (GE1) 2.5 i V6 (GE1/GE7)	85	07.91 07.91	08.97 08.97	BA2118			21754 15,8 +/WK <b>SUM</b>
	2.0 i (GE1) 2.5 i V6 (GE1/GE7)	85	07.91 07.91	08.97 08.97	BAR24129			258 24,0 22,0 V
<b>MAZDA PREMACY (99-05)</b>								
	1.8 i 16V 1.8 i 16V 2.0 DiTD 2.0 DiTD	74 84 66 74	07.99 07.99 10.99 07.00	07.01 07.01 06.00 07.01	BA2118			21754 15,8 +/WK <b>SUM</b>
	1.8 i 16V 1.8 i 16V 2.0 DiTD 2.0 DiTD	74 84 66 74	07.99 07.99 10.99 07.00	07.01 07.01 06.00 07.01	BAR24129			258 24,0 22,0 V
	1.8 i 16V 2.0 DiTD 2.0 i 16V	74 74 96	07.99 07.00 11.01	02.05 + ABS 02.05 + ABS 02.05	BA2257			24045 13,1 <b>AKE</b>
<b>MAZDA PREMACY (05-)</b>								
	1.8 i 16V 2.0 CiTD 2.0 CiTD 2.0 CiTD 2.0 i 16V	85 81 105 107 107	03.05 03.05 06.05 03.05 03.05		BA2234			23723 18,4 + <b>ATE</b>
	1.8 i 16V 2.0 CiTD 2.0 CiTD 2.0 CiTD 2.0 i 16V	85 81 105 107 107	03.05 03.05 06.05 03.05 03.05		BA2258			23482 16,4 + <b>ATE</b>
<b>MAZDA XEDOS 6 (92-00)</b>								
	1.6 i 16V (CA1) 2.0 i V6 (CA1)		06.92 06.92	09.99 10.00	BA2118			21754 15,8 +/WK <b>SUM</b>
	1.6 i 16V (CA1) 2.0 i V6 (CA1)		06.92 06.92	09.99 10.00	BAR24129			258 24,0 22,0 V
<b>MERCEDES BENZ A-Klasse (W168) (97-04)</b>								
	A 140 A 160 CDI A 160 CDI	44 55	09.97 08.98 02.01	08.04 + kurzer Radstand <sup>1)</sup> 01.01 08.04	BA2176 BAV1004	1		23070 17,0 /WK/S <b>LUC</b> Warnkontakt L=94mm
	A 140 A 160 A 170 CDI A 170 CDI A 190	66 70	09.97 09.97 03.98 02.01 05.99	08.04 - kurzer Radstand <sup>2)</sup> 08.04 - (BR) 01.01 08.04 08.04 - (BR)	BA2176 BAV1004	1		23070 17,0 /WK/S <b>LUC</b> Warnkontakt L=94mm
	A 160 A 190 A 210 Evolution		05.99 05.99 03.02	08.04 + (BR) 08.04 + (BR) 08.04	BAV1004	1		Warnkontakt L=94mm
	A 140 A 160 CDI A 160 CDI	44 55	09.97 08.98 02.01	08.04 + kurzer Radstand <sup>1)</sup> 01.01 08.04	BAR12144			260 12,0 10,0 L
	A 140 A 160 A 170 CDI A 170 CDI A 190	66 70	09.97 09.97 03.98 02.01 05.99	08.04 - kurzer Radstand <sup>2)</sup> 08.04 01.01 08.04 08.04 + (BR)	BAR22168			260 22,0 19,4 V L
	A 140 A 160 A 160 CDI A 160 CDI A 170 CDI	44 55 66	09.97 09.97 08.98 02.01 03.98	08.04 08.04 01.01 08.04 01.01	BAH0006	2		L=280

1) + short wheel base / + passo lungo / + empattement court / + distancia corta entre ejes

2) - short wheel base / - passo corto / - empattement court / - distancia corta entre ejes

								
<b>MERCEDES BENZ A-Klasse (W168) (97-04)</b>								
	A 170 CDI A 190 A 210 Evolution	70		02.01 08.04 05.99 08.04 03.02 08.04		BAH0006	2	L=280
	A 160 A 170 CDI A 190 A 210 Evolution	70		09.97 08.04 02.01 08.04 05.99 08.04 03.02 08.04	- kurzer Radstand <sup>1)</sup> - kurzer Radstand <sup>1)</sup> - (BR)	BA2220		23138 14,6 / S LUC
	A 160 A 170 CDI A 190 A 210 Evolution	70		09.97 08.04 02.01 08.04 05.99 08.04 03.02 08.04	- kurzer Radstand <sup>1)</sup> - kurzer Radstand <sup>1)</sup> - (BR)	BAR08111		258 8,0 7,0
	A 140 A 160 A 160 CDI A 160 CDI A 170 CDI A 170 CDI	J078974 J078974 44 55 66 J078974 70		08.04 08.04 08.98 01.01 02.01 08.04 01.01 02.01 08.04	+ kurzer Radstand / - (BR) <sup>2)</sup>	BAW1706		Rz 17,78 LUC
	A 140 A 160 A 160 CDI A 160 CDI A 170 CDI A 170 CDI	44 55 66 70		09.97 08.04 09.97 08.04 08.98 01.01 02.01 08.04 03.98 01.01 02.01 08.04	+ kurzer Radstand / - (BR) <sup>2)</sup>	BAE5007		180 x 42 HEB LUC
<b>MERCEDES BENZ A-Klasse (W169) (04-11)</b>								
	A 150 / A 160 A 160 CDI A 160 CDI		J 300470 J 300471	08.04 10.11 08.04 10.11 10.11		BA2266 BAV1046 BA2266 BAV1046	1 1	24077 18,3 /WE/S LUC Warnkontakt L=95mm 24077 18,3 /WE/S LUC Warnkontakt L=95mm
	A 170 A 180 A 180 CDI A 200			08.04 10.11 04.09 10.11 08.04 10.11 08.04 10.11		BA2266 BAV1046	1	24077 18,3 /WE/S LUC Warnkontakt L=95mm
	A 200 CDI A 200 Turbo E-Cell			08.04 10.11 03.05 10.11 12.10 10.11		BA2310 BAV1046	1	23881 20,1 /WE/S LUC Warnkontakt L=95mm
	E-Cell A 150 / A 160 A 160 CDI A 170 A 180 A 180 CDI A 200 A 200 CDI A 200 Turbo			12.10 10.11 08.04 10.11 08.04 10.11 08.04 10.11 04.09 10.11 08.04 10.11 08.04 10.11 08.04 10.11 03.05 10.11		BA2220 BA2220		23138 14,6 / S LUC 23138 14,6 / S LUC
<b>MERCEDES BENZ B-Klasse (W245) (05-11)</b>								
	B 150 / B 160 B 160 BlueEfficiency B 170 / B 180 B 170 NGT B 180 BlueEfficiency			03.05 04.11 04.09 04.11 03.05 04.11 04.08 04.09 04.09 04.11		BA2266 BAV1046	1	24077 18,3 /WE/S LUC Warnkontakt L=95mm
	B 170 NGT B 180 CDI B 180 NGT B 200 B 200 CDI B 200 Turbo			04.08 04.09 03.05 04.11 04.09 04.11 03.05 04.11 03.05 04.11 03.05 04.11		BA2310 BAV1046	1	23881 20,1 /WE/S LUC Warnkontakt L=95mm
	B 150 / B 160 B 160 BlueEfficiency B 170 / B 180 B 170 NGT B 180 BlueEfficiency B 180 CDI B 180 NGT B 200 B 200 CDI B 200 Turbo			03.05 04.11 04.09 04.11 03.05 04.11 04.08 04.09 04.09 04.11 03.05 04.11 04.09 04.11 03.05 04.11 03.05 04.11 03.05 04.11		BA2220		23138 14,6 / S LUC
<b>MERCEDES BENZ C-Klasse (W202) Limousine (93-00)</b>								
	C 180 C 200 C 200 CDI C 200 D C 220 C 220 CDI C 220 D C 230 C 250 D C 280 C 280		F331440 A344660	03.93 05.00 01.94 05.00 03.98 05.00 03.93 05.00 03.93 08.96 09.97 05.00 06.93 05.00 07.96 06.97 06.93 08.95 06.93 06.93		BA2044 BAV1004	2	21439 20,3 /WE/S LUC Warnkontakt L=94mm
	C 200 Kompressor C 230 Kompressor C 240 C 250 TD			10.95 05.00 09.95 05.00 06.97 05.00 09.95 05.00		BA2150 BAV1004	2	21664 19,1 +/-WE ATE Warnkontakt L=94mm

<sup>1)</sup> - short wheel base / - passo corto / - empattement court / - distancia corta entre ejes

<sup>2)</sup> + short wheel base / - (BR) / + passo corto / - (BR) / + empattement court / - (BR) / + distanc.corta entre ejes / - (BR)

(BR)





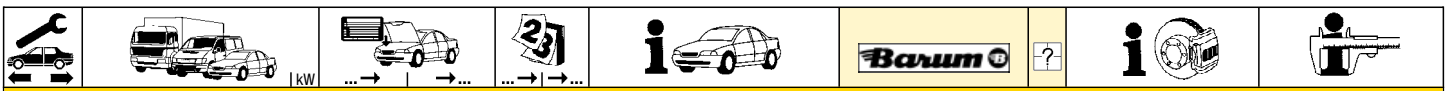

<sup>3)</sup> + short wheel base / + passo lungo / + empattement court / + distancia corta entre ejes





















**MERCEDES BENZ C-Klasse (W202) Limousine (93-00)**

	C 280 C 280	A344661 F331441		05.00 05.00		BA2150 BAV1004	2		21664 19,1 +/WE Warnkontakt L=94mm	ATE
	C 36 AMG			05.94	08.97	BA2182 BAV1004	2		21153 17,5 /WE Warnkontakt L=94mm	ATE
	C 180 C 200 D C 220 D C 250 D			03.93 03.93 06.93 06.93	05.00 05.00 05.00 08.95	BAR12128			284 12,0 10,0 L	
	C 200 C 200 CDI C 220 C 220 CDI C 230 C 280 C 280		F331440 A344660	01.94 03.98 03.93 09.97 07.96 06.93 06.93	05.00 05.00 08.96 05.00 06.97 05.00 05.00	BAR22132			284 22,0 19,4 V L	
	C 200 Kompressor C 230 Kompressor C 240 C 250 TD C 280 C 280			10.95 09.95 06.97 09.95 05.00 05.00	05.00 05.00 05.00 05.00 05.00 05.00	BAR25110			288 25,0 22,4 V L	
	C 180 C 180 C 200 C 200 C 200 D C 200 D C 220 C 220 C 220 D C 220 D C 250 D C 250 D C 280 C 280 C 36 AMG C 36 AMG		F331440 A344660 F331440 A344660 F331440 A344660 F331440 A344660 F331440 A344660 F331440 A344660 F331440 A344660 F331440 A344660 F331440 A344660	03.93 03.93 01.94 01.94 03.93 03.93 03.93 06.93 06.93 06.93 06.93 06.93 06.93 06.93 06.93 05.94 05.94		BAH0028	2		L=480	
	C 180 C 180 C 200 C 200 C 200 CDI C 200 D C 200 D C 200 Kompressor C 220 C 220 C 220 CDI C 220 D C 220 D C 230 C 230 Kompressor C 240 C 250 D C 250 D C 250 TD C 280 C 280 C 36 AMG C 36 AMG C 43 AMG	A344661 F331441 A344661 F331441 A344661 F331441 F331441 A344661 F331441 A344661 F331441 A344661 F331441 A344661 F331441 A344661 F331441 A344661 F331441 A344661 F331441 A344661 F331441		05.00 05.00 05.00 05.00 03.98 05.00 05.00 05.00 10.95 05.00 08.96 08.96 09.97 05.00 05.00 05.00 07.96 06.97 09.95 05.00 06.97 05.00 08.95 08.95 09.95 05.00 05.00 08.97 08.97 09.97 05.00		BAH0018	2		L=385	
	C 180 C 180 C 200 C 200 C 200 D C 200 D C 220 C 220 C 220 D C 220 D C 250 D C 250 D C 280 C 280		F443892 A419828 F443892 A419828 F443892 A419828 F443892 A419828 F443892 A419828 F443892 A419828 F443892 A419828 F443892 A419828 F331440 A344660	03.93 03.93 01.94 01.94 03.93 03.93 03.93 03.93 06.93 06.93 06.93 06.93 06.93 06.93 06.93 06.93 06.93 06.93		BA2094			20687 15,5	ATE
	C 180 C 180 C 200 C 200 C 200 CDI C 200 D C 200 D C 220 C 220 C 220 CDI C 220 D	142 142	A419829 F443893 A419829 F443893 A419829 F443893 A419829 F443893 A419829 F443893	05.00 05.00 05.00 05.00 03.98 05.00 05.00 05.00 08.96 08.96 09.97 05.00		BA2213			21900 15,8	ATE
	C 280 C 280		F331440 A344660	06.93 06.93		- ASRV - ETS - ASRV - ETS				

												
MERCEDES BENZ C-Klasse (W202) Limousine (93-00)												
	C 220 D	F443893		07.96	05.00	BA2213			21900 15,8	ATE		
	C 230				06.97							
	C 250 D	A419829			08.95							
	C 250 D	F443893			08.95							
	C 200 Kompressor		F576240		10.95	05.00	BA2161			21197 15,0 /WE	ATE	
	C 200 Kompressor		A487047		10.95	05.00	BAV1004	1		Warnkontakt L=94mm		
	C 230 Kompressor		F576240		09.95	05.00						
	C 230 Kompressor		A487047		09.95	05.00						
	C 240		F576240		06.97	05.00						
	C 240		A487047		06.97	05.00						
	C 250 TD		F576240		09.95	05.00						
	C 250 TD		A487047		09.95	05.00						
	C 280	142 A344661				05.97	- ASR/ - ETS					
	C 280	142 F331441				05.97	- ASR/ - ETS					
C 280	145	F576240		06.97	05.00							
C 280	145	A487047		06.97	05.00							
C 36 AMG		F331440			05.94							
C 36 AMG		A344660			05.94							
	C 200 Kompressor		A487048		05.00	05.00	BA2164			21919 15,8	ATE	
	C 200 Kompressor		F576241		05.00	05.00						
	C 230 Kompressor		A487048		05.00	05.00						
	C 230 Kompressor		F576241		05.00	05.00						
	C 240		A487048		05.00	05.00						
	C 240		F576241		05.00	05.00						
	C 250 TD		A487048		05.00	05.00						
	C 250 TD		F576241		05.00	05.00						
	C 280	145 A487048			05.00	05.00						
	C 280	145 F576241			05.00	05.00						
	C 280	142			06.93	05.97	+ ASR/ + ETS	BAV1004	1		Warnkontakt L=94mm	
	C 36 AMG	A344661				08.97		BA2163			21305 15,5 /WE	ATE
	C 36 AMG	F331441				08.97		BAV1004	1		Warnkontakt L=94mm	
	C 43 AMG				09.97	05.00						
	C 180				03.93	05.00	BAR09120			258 9,0 7,3		
	C 200				01.94	05.00						
	C 200 CDI				03.98	05.00						
	C 200 D				03.93	05.00						
	C 220				03.93	08.96						
	C 220 CDI				09.97	05.00						
	C 220 D				06.93	05.00						
	C 230				07.96	06.97						
	C 250 D				06.93	08.95						
	C 280	142	F331440			06.93						
	C 280	142	A344660			06.93						
	C 200 Kompressor				10.95	05.00		BAR09114			278 9,0 7,3	
	C 230 Kompressor				09.95	05.00						
	C 240				06.97	05.00						
C 250 TD				09.95	05.00							
C 280	142 A344661				05.97							
C 280	142 F331441				05.97							
C 280	145			06.97	05.00							
C 36 AMG	A344661				08.97		BAR10217			290 10,0 8,3		
C 36 AMG	F331441				08.97							
	C 180				03.93	08.95	BAH0004	2		L=280		
	C 200				01.94	08.95						
	C 200 D				03.93	08.95						
	C 220				03.93	08.95						
	C 220 D				06.93	08.95						
	C 250 D				06.93	08.95						
	C 280				06.93	08.95						
	C 180				09.95	05.00		BAH0006	2		L=280	
	C 200				09.95	05.00						
	C 200 CDI				03.98	05.00						
	C 200 D				09.95	05.00						
	C 200 Kompressor				10.95	05.00						
	C 220				09.95	08.96						
	C 220 CDI				09.97	05.00						
C 220 D				09.95	05.00							
C 230				07.96	06.97							
C 230 Kompressor				09.95	05.00							
C 240				06.97	05.00							
C 250 TD				09.95	05.00							
C 280				09.95	05.00							
C 36 AMG				05.94	08.97							
C 43 AMG				09.97	05.00							
MERCEDES BENZ C-Klasse (S202) Kombi (96-01)												
	C 180				06.96	04.01	BA2044			21439 20,3 /WE/S	LUC	
	C 200				06.96	04.01	BAV1004	2		Warnkontakt L=94mm		
	C 200 CDI				03.98	04.01						
	C 200 D				07.96	04.01						
	C 220 CDI				09.97	04.01						
	C 220 D				06.96	04.01						
	C 230				06.96	06.97						
	C 200 Kompressor				11.96	04.01	BA2150			21664 19,1 +/WE	ATE	
	C 230 Kompressor				06.97	04.01	BAV1004	2		Warnkontakt L=94mm		
	C 240				06.97	04.01						













								
<b>MERCEDES BENZ C-Klasse (S202) Kombi (96-01)</b>								
	C 250 TD C 280		06.96 06.97	04.01 04.01	BA2150 BAV1004	2		21664 19,1 +/WE Warnkontakt L=94mm ATE
	C 180 C 200 C 200 CDI C 200 D C 220 CDI C 220 D C 230		06.96 06.96 03.98 07.96 09.97 06.96 06.96	04.01 04.01 04.01 04.01 04.01 04.01 06.97	BAR22132			284 22,0 19,4 V L
	C 200 Kompressor C 230 Kompressor C 240 C 250 TD C 280		11.96 06.97 06.97 06.96 06.97	04.01 04.01 04.01 04.01 04.01	BAR25110			288 25,0 22,4 V L
	C 180 C 200 C 200 CDI C 200 D C 200 Kompressor C 220 CDI C 220 D C 230 C 230 Kompressor C 240 C 250 TD C 280 C 43 AMG		06.96 06.96 03.98 07.96 11.96 09.97 06.96 06.96 06.97 06.97 06.96 06.97 09.97	04.01 04.01 04.01 04.01 04.01 04.01 04.01 06.97 04.01 04.01 04.01 04.01	BAH0018	2		L=385
	C 180 C 200 C 200 CDI C 200 D C 200 Kompressor C 220 CDI C 220 D C 230 C 250 TD	F576240 F576240 F576240 F576240 F576240 F576240 F576240 F576240	06.96 06.96 03.98 07.96 11.96 09.97 06.96 06.96		BA2161 BAV1004	1		21197 15,0 /WE Warnkontakt L=94mm ATE
	C 180 C 200 C 200 CDI C 200 D C 200 Kompressor C 220 CDI C 220 D C 230 C 230 Kompressor C 240 C 250 TD C 280 C 43 AMG	F576241 F576241 F576241 F576241 F576241 F576241 F576241 F576241 F576241 F576241		04.01 04.01 04.01 04.01 04.01 04.01 06.97 06.97 04.01 04.01 04.01 04.01	BA2164			21919 15,8 ATE
	C 43 AMG		09.97	04.01	BA2163 BAV1004	1		21305 15,5 /WE Warnkontakt L=94mm ATE
	C 180 C 200 C 200 CDI C 200 D C 200 Kompressor C 220 CDI C 220 D C 230 C 230 Kompressor C 240 C 250 TD C 280		06.96 06.96 03.98 07.96 11.96 09.97 06.96 06.96 06.97 06.97 06.96 06.96	04.01 04.01 04.01 04.01 04.01 04.01 04.01 06.97 04.01 04.01 04.01 04.01	BAR09114			278 9,0 7,3
	C 180 C 200 C 200 CDI C 200 D C 200 Kompressor C 220 CDI C 220 D C 230 C 230 Kompressor C 240 C 250 TD C 280 C 43 AMG		06.96 06.96 03.98 07.96 11.96 09.97 06.96 06.96 06.97 06.97 06.96 06.96	04.01 04.01 04.01 04.01 04.01 04.01 04.01 06.97 04.01 04.01 04.01 04.01	BAH0006	2		L=280
<b>MERCEDES BENZ C-Klasse (W203) Limousine (00-07)</b>								
	C 180 C 180 Kompressor C 200 CDI C 200 CGI Kompressor C 200 Kompressor C 220 CDI C 230 Kompressor C 320 CDI		04.00 05.02 04.00 07.03 04.00 04.00 02.04 02.05	04.07 04.07 04.07 04.07 04.07 04.07 04.07 04.07	BA2177 BAV1046	2	- Sportpaket <sup>1)</sup>	23144 19,8 +/WE/S Warnkontakt L=95mm LUC
								

<sup>1)</sup> - sports package / - pacchetto sportivo / - version Sport / - kit deportivo















**MERCEDES BENZ C-Klasse (W203) Limousine (00-07)**

←	C 180		04.00	04.07		BA2177	1		23144 19,8 +/WE/S Warnkontakt L=95mm	LUC
	C 180 Kompressor		05.02	04.07	- Sportpaket / - Sportpaket AMG	BAV1046				
	C 200 CDI	90	04.00	04.07	- Sportpaket / - Sportpaket AMG					
	C 200 CDI		04.03	04.07	- Sportpaket / - Sportpaket AMG					
	C 200 CGI Kompressor		07.03	04.07	- Sportpaket / - Sportpaket AMG					
	C 200 Kompressor		04.00	04.07	- Sportpaket / - Sportpaket AMG					
	C 200 Kompressor	120	05.00	05.02						
	C 220 CDI		04.00	04.07	- Sportpaket / - Sportpaket AMG					
	C 220 CDI	110	02.04	04.07	- Sportpaket / - Sportpaket AMG					
	C 180 Kompressor		565688	05.02	+ Sportpaket / + Sportpaket AMG	BA2184	1		23271 17,7 /WE 23745 17,7 +/WE Warnkontakt L=95mm	BRE
	C 200 CDI	90	565688	04.00	04.07	BA2204				
	C 200 CDI		565688	04.03	+ Sportpaket / + Sportpaket AMG	BAV1046				
	C 200 CGI Kompressor		565688	07.03	+ Sportpaket / + Sportpaket AMG					
	C 200 Kompressor		565688	04.00	+ Sportpaket / + Sportpaket AMG					
	C 220 CDI		565688	04.00	04.07	+ Sportpaket / + Sportpaket AMG				
	C 220 CDI	110	565688	02.04	+ Sportpaket / + Sportpaket AMG					
	C 230 Kompressor		565688	02.04	+ Sportpaket / + Sportpaket AMG					
	C 240		565688	04.00	+ Sportpaket / + Sportpaket AMG					
	C 270 CDI		565688	08.00	+ Sportpaket / + Sportpaket AMG					
	C 320		565688	04.00	+ Sportpaket / + Sportpaket AMG					
	C 180 Kompressor	565689		04.07	+ Sportpaket / + Sportpaket AMG	BAV1046	1		Warnkontakt L=95mm	
	C 200 CDI	90 565689		04.07	+ Sportpaket / + Sportpaket AMG					
	C 200 CGI Kompressor	565689		04.07	+ Sportpaket / + Sportpaket AMG					
	C 200 Kompressor	565689		04.07	+ Sportpaket / + Sportpaket AMG					
	C 220 CDI	110 565689		04.07	+ Sportpaket / + Sportpaket AMG					
	C 230			06.05	04.07	+ Sportpaket / + Sportpaket AMG				
	C 230 Kompressor	565689		04.07	+ Sportpaket / + Sportpaket AMG					
	C 240	565689		04.07	+ Sportpaket / + Sportpaket AMG					
	C 270 CDI	565689		04.07	+ Sportpaket / + Sportpaket AMG					
	C 280			06.05	04.07	+ Sportpaket / + Sportpaket AMG				
	C 280 4-Matic			06.05	04.07	+ Sportpaket / + Sportpaket AMG				
	C 320	565689		04.07	+ Sportpaket / + Sportpaket AMG					
	C 320 CDI			02.05	04.07	- Sportpaket / - Sportpaket AMG				
	C 350			06.05	04.07	- Sportpaket / - Sportpaket AMG				
	C 230			06.05	04.07	- Sportpaket / - Sportpaket AMG	BA2177	1	23144 19,8 +/WE/S Warnkontakt L=95mm	LUC
	C 230 Kompressor			02.04	04.07	- Sportpaket / - Sportpaket AMG	BAV1046			
	C 240			04.00	04.07	- Sportpaket / - Sportpaket AMG				
	C 240 4-Matic			07.02	04.07					
	C 270 CDI			08.00	04.07	- Sportpaket / - Sportpaket AMG				
	C 280			06.05	04.07	- Sportpaket / - Sportpaket AMG				
	C 280 4-Matic			06.05	04.07	- Sportpaket / - Sportpaket AMG				
	C 320			04.00	04.07	- Sportpaket / - Sportpaket AMG				
	C 320 4-Matic			07.02	04.07					
	C 30 CDI AMG			01.03	04.07		BA2184	1	23271 17,7 /WE 23745 17,7 +/WE Warnkontakt L=95mm	BRE
	C 320 CDI			02.05	04.07	+ Sportpaket / + Sportpaket AMG	BA2204			
	C 350			06.05	04.07	+ Sportpaket / + Sportpaket AMG	BAV1046			

1) + sports package / + pacchetto sportivo / + version Sport / + kit sportivo  
 2) + AMG sports package / + pacchetto sportivo AMG / + version Sport AMG / + kit sportivo AMG



									
<b>MERCEDES BENZ C-Klasse (W203) Limousine (00-07)</b>									
	C 350 4-Matic		06.05	04.07			BA2184 BA2204 BAV1046	23271 17,7 /WE 23745 17,7 +/WE Warnkontakt L=95mm	<b>BRE</b> <b>BRE</b>
	C 32 AMG Kompressor C 55 AMG		03.01 02.04	04.07 04.07			BA2204 BA2184 BAV1046	23745 17,7 +/WE 23271 17,7 /WE Warnkontakt L=95mm	<b>BRE</b> <b>BRE</b>
	C 180 C 180 Kompressor C 200 CDI C 200 CDI C 200 CGI Kompressor C 200 Kompressor C 200 Kompressor C 220 CDI C 220 CDI	90     120  110	04.00 05.02 04.00 04.03 07.03 04.00 05.00 04.00 02.04	04.07 04.07 04.07 04.07 04.07 04.07 05.02 04.07 04.07	- Sportpaket / - Sportpaket AMG - Sportpaket / - Sportpaket AMG - Sportpaket / - Sportpaket AMG - Sportpaket / - Sportpaket AMG - Sportpaket / - Sportpaket AMG - Sportpaket / - Sportpaket AMG - Sportpaket / - Sportpaket AMG - Sportpaket / - Sportpaket AMG		BAR25110	288 25,0 22,4 V L	
	C 230 C 230 Kompressor C 240 C 240 4-Matic C 270 CDI C 280 C 280 4-Matic C 320 C 320 4-Matic		06.05 02.04 04.00 07.02 08.00 06.05 06.05 04.00 07.02	04.07 04.07 04.07 04.07 04.07 04.07 04.07 04.07 04.07	- Sportpaket / - Sportpaket AMG - Sportpaket / - Sportpaket AMG - Sportpaket / - Sportpaket AMG - Sportpaket / - Sportpaket AMG - Sportpaket / - Sportpaket AMG - Sportpaket / - Sportpaket AMG - Sportpaket / - Sportpaket AMG - Sportpaket / - Sportpaket AMG		BAR28106	300 28,0 25,4 V L	
	C 180 C 180 Kompressor C 200 CDI C 200 CDI C 200 CGI Kompressor C 200 Kompressor C 200 Kompressor C 220 CDI C 220 CDI C 230 C 230 Kompressor C 240 C 270 CDI C 280 C 30 CDI AMG C 32 AMG Kompressor C 320 C 320 CDI C 350 C 55 AMG	90     120  110	04.00 05.02 04.00 04.03 07.03 04.00 05.00 04.00 02.04 06.05 02.04 04.00 08.00 06.05 01.03 03.01 04.00 02.05 06.05 02.04	04.07 04.07 04.07 04.07 04.07 04.07 05.02 04.07 04.07 04.07 04.07 04.07 04.07 04.07 04.07 04.07 04.07 04.07 04.07 04.07			BAH0018	L=385	2
	C 180 C 180 Kompressor C 200 CDI C 200 CDI C 200 CGI Kompressor C 200 Kompressor	90	04.00 05.02 04.00 04.03 07.03 04.00	04.07 04.07 04.07 04.07 04.07 04.07	- Sportpaket / - Sportpaket AMG - Sportpaket / - Sportpaket AMG - Sportpaket / - Sportpaket AMG - Sportpaket / - Sportpaket AMG		BA2164 BAV1046	21919 15,8 Warnkontakt L=95mm	<b>ATE</b>

1) - sports package / - pacchetto sportivo / - version Sport / - kit deportivo  
2) + sports package / + pacchetto sportivo / + version Sport / + kit deportivo





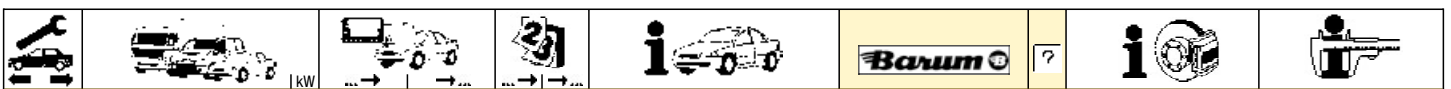







									
<b>MERCEDES BENZ C-Klasse (W203) Limousine (00-07)</b>									
	C 200 Kompressor	120	05.00	05.02		BA2164	1	21919 15,8 Warnkontakt L=95mm	ATE
	C 220 CDI	110	04.00	04.07	- Sportpaket / - Sportpaket AMG	BAV1046			
	C 180 Kompressor		05.02	04.07	+ Sportpaket / + Sportpaket AMG	BA2206 BAV1046	1	21899 15,1 /WE Warnkontakt L=95mm	ATE
	C 200 CDI		04.00	04.07	+ Sportpaket / + Sportpaket AMG				
	C 200 CDI	90	04.03	04.07	+ Sportpaket / + Sportpaket AMG				
	C 200 CGI Kompressor		07.03	04.07	+ Sportpaket / + Sportpaket AMG				
	C 200 Kompressor		04.00	04.07	+ Sportpaket / + Sportpaket AMG				
	C 220 CDI	110	04.00	04.07	+ Sportpaket / + Sportpaket AMG				
	C 220 CDI		02.04	04.07	+ Sportpaket / + Sportpaket AMG				
	C 230		06.05	04.07					
	C 230 Kompressor		02.04	04.07					
	C 240		04.00	04.07					
	C 240 4-Matic		07.02	04.07					
	C 270 CDI		08.00	04.07					
	C 280		06.05	04.07					
	C 280 4-Matic		06.05	04.07					
	C 320		04.00	04.07					
	C 320 4-Matic		07.02	04.07					
	C 320 CDI		02.05	04.07					
	C 350		06.05	04.07					
	C 350 4-Matic		06.05	04.07					
		C 30 CDI AMG		01.03	04.07				
C 32 AMG Kompressor			03.01	04.07					
C 55 AMG			02.04	04.07					
	C 180		04.00	04.07		BAR09114		278 9,0 7,3	
	C 180 Kompressor		05.02	04.07	- Sportpaket / - Sportpaket AMG				
	C 200 CDI	90	04.00	04.07	- Sportpaket / - Sportpaket AMG				
	C 200 CDI		04.03	04.07	- Sportpaket / - Sportpaket AMG				
	C 200 CGI Kompressor		07.03	04.07	- Sportpaket / - Sportpaket AMG				
	C 200 Kompressor		04.00	04.07	- Sportpaket / - Sportpaket AMG				
	C 200 Kompressor	120	05.00	05.02					
	C 220 CDI	110	04.00	04.07	- Sportpaket / - Sportpaket AMG				
	C 220 CDI		02.04	04.07	- Sportpaket / - Sportpaket AMG				
	C 230		06.05	04.07	- Sportpaket / - Sportpaket AMG				
	C 180 Kompressor		05.02	04.07	+ Sportpaket / + Sportpaket AMG	BAR10217		290 10,0 8,3	
	C 200 CDI	90	04.00	04.07	+ Sportpaket / + Sportpaket AMG				
	C 200 CDI		04.03	04.07	+ Sportpaket / + Sportpaket AMG				
	C 200 CGI Kompressor		07.03	04.07	+ Sportpaket / + Sportpaket AMG				
	C 200 Kompressor		04.00	04.07	+ Sportpaket / + Sportpaket AMG				
	C 220 CDI	110	04.00	04.07	+ Sportpaket / + Sportpaket AMG				
	C 220 CDI		02.04	04.07	+ Sportpaket / + Sportpaket AMG				
	C 230		06.05	04.07	+ Sportpaket / + Sportpaket AMG				
	C 230 Kompressor		02.04	04.07					
	C 240		04.00	04.07					
	C 240 4-Matic		07.02	04.07					
	C 270 CDI		08.00	04.07					
	C 280		06.05	04.07					
	C 280 4-Matic		06.05	04.07					
	C 320		04.00	04.07					
	C 320 4-Matic		07.02	04.07					
	C 320 CDI		02.05	04.07					
C 350		06.05	04.07						
C 350 4-Matic		06.05	04.07						
	C 180		04.00	04.07		BAH0006	2	L=280	
	C 180 Kompressor		05.02	04.07					
	C 200 CDI	90	04.00	04.07					
	C 200 CDI		04.03	04.07					
	C 200 CGI Kompressor		07.03	04.07					
	C 200 Kompressor		04.00	04.07					
	C 200 Kompressor	120	05.00	05.02					
	C 220 CDI	110	04.00	04.07					
	C 220 CDI		02.04	04.07					
	C 230		06.05	04.07					
	C 230 Kompressor		02.04	04.07					
	C 240		04.00	04.07					
C 240 4-Matic		07.02	04.07						
C 270 CDI		08.00	04.07						

1) + sports package / + pacchetto sportivo / + version Sport / + kit deportivo

2) - sports package / - pacchetto sportivo / - version Sport / - kit deportivo



									
MERCEDES BENZ C-Klasse (W203) Limousine (00-07)									
	C 280 C 280 4-Matic C 30 CDI AMG C 32 AMG Kompressor C 320 C 320 4-Matic C 320 CDI C 350 C 350 4-Matic C 55 AMG			06.05 06.05 01.03 03.01 04.00 07.02 02.05 06.05 06.05 02.04	04.07 04.07 04.07 04.07 04.07 04.07 04.07 04.07 04.07 04.07	BAH0006	2		L=280
MERCEDES BENZ C-Klasse (S203) Kombi (01-07)									
	C 180 C 180 Kompressor C 200 CDI C 200 CDI C 200 CGI Kompressor C 200 Kompressor C 200 Kompressor C 220 CDI C 220 CDI			03.01 05.02 03.01 04.03 07.03 05.02 03.01 03.01 02.04	09.07 09.07 - Sportpaket / - Sportpaket AMG 09.07 - Sportpaket / - Sportpaket AMG 09.07 - Sportpaket / - Sportpaket AMG 09.07 - Sportpaket / - Sportpaket AMG 09.07 - Sportpaket / - Sportpaket AMG 04.02 09.07 - Sportpaket / - Sportpaket AMG 09.07 - Sportpaket / - Sportpaket AMG	BA2177 BAV1046	2		23144 19,8 +/-WE/S LUC Warnkontakt L=95mm
	C 180 Kompressor C 200 CDI C 200 CDI C 200 CGI Kompressor C 200 Kompressor C 220 CDI C 220 CDI C 240 C 270 CDI C 320	90 120 110	565688 565688 565688 565688 565688 565688 565688 565688 565688	05.02 03.01 04.03 07.03 05.02 03.01 02.04 03.01 03.01 03.01	+ Sportpaket / + Sportpaket AMG + Sportpaket / + Sportpaket AMG + Sportpaket / + Sportpaket AMG + Sportpaket / + Sportpaket AMG + Sportpaket / + Sportpaket AMG + Sportpaket / + Sportpaket AMG + Sportpaket / + Sportpaket AMG + Sportpaket / + Sportpaket AMG + Sportpaket / + Sportpaket AMG + Sportpaket / + Sportpaket AMG	BA2204 BA2184 BAV1046	2		23745 17,7 +/-WE BRE 23271 17,7 /WE BRE Warnkontakt L=95mm
	C 30 CDI AMG C 320 CDI C 350 C 350 4-Matic			01.03 02.05 06.05 06.05	09.07 09.07 + Sportpaket / + Sportpaket AMG 09.07 + Sportpaket / + Sportpaket AMG 09.07	BA2204 BA2184 BAV1046	2		23745 17,7 +/-WE BRE 23271 17,7 /WE BRE Warnkontakt L=95mm
	C 180 Kompressor C 200 CDI C 200 CGI Kompressor	565689 90 565689 565689			09.07 09.07 09.07	+ Sportpaket / + Sportpaket AMG + Sportpaket / + Sportpaket AMG + Sportpaket / + Sportpaket AMG	BAV1046	2	Warnkontakt L=95mm

1) - sports package / - pacchetto sportivo / - version Sport / - kit deportivo  
2) + sports package / + pacchetto sportivo / + version Sport / + kit deportivo  
3) + AMG sports package / + pacchetto sportivo AMG / + version Sport AMG / + kit deportivo AMG

								
<b>MERCEDES BENZ C-Klasse (S203) Kombi (01-07)</b>								
	C 200 Kompressor	565689		09.07	+ Sportpaket / + Sportpaket AMG	BAV1046	2	Warnkontakt L=95mm
	C 220 CDI	110 565689		09.07	+ Sportpaket / + Sportpaket AMG			
	C 230			06.05	09.07 + Sportpaket / + Sportpaket AMG			
	C 230 Kompressor			02.04	09.07 + Sportpaket / + Sportpaket AMG			
	C 240				09.07 + Sportpaket / + Sportpaket AMG			
	C 240	565689			09.07 + Sportpaket / + Sportpaket AMG			
	C 270 CDI	565689			09.07 + Sportpaket / + Sportpaket AMG			
	C 280			06.05	09.07 + Sportpaket / + Sportpaket AMG			
	C 280 4-Matic			06.05	09.07 + Sportpaket / + Sportpaket AMG			
	C 320	565689			09.07 + Sportpaket / + Sportpaket AMG			
	C 320 CDI			02.05	09.07 - Sportpaket / - Sportpaket AMG			
	C 350			06.05	09.07 - Sportpaket / - Sportpaket AMG			
	C 230			06.05	09.07 - Sportpaket / - Sportpaket AMG			
	C 230 Kompressor			02.04	09.07 - Sportpaket / - Sportpaket AMG			
	C 240			03.01	09.07 - Sportpaket / - Sportpaket AMG			
C 240 4-Matic			07.02	09.07 - Sportpaket / - Sportpaket AMG				
C 270 CDI			03.01	09.07 - Sportpaket / - Sportpaket AMG				
C 280			06.05	09.07 - Sportpaket / - Sportpaket AMG				
C 280 4-Matic			06.05	09.07 - Sportpaket / - Sportpaket AMG				
C 320			03.01	09.07 - Sportpaket / - Sportpaket AMG				
C 320 4-Matic			07.02	09.07				
C 32 Kompressor AMG			03.01	09.07				
C 55 AMG			02.04	09.07				
					BA2177 BAV1046	2	23144 19,8 +/WE/S Warnkontakt L=95mm	LUC
	C 180			03.01	09.07	BAR25110		288 25,0 22,4 V L
	C 180 Kompressor			05.02	09.07 - Sportpaket / - Sportpaket AMG			
	C 200 CDI			03.01	09.07 - Sportpaket / - Sportpaket AMG			
	C 200 CDI	90		04.03	09.07 - Sportpaket / - Sportpaket AMG			
	C 200 CGI Kompressor			07.03	09.07 - Sportpaket / - Sportpaket AMG			
	C 200 Kompressor			05.02	09.07 - Sportpaket / - Sportpaket AMG			
	C 200 Kompressor	120		03.01	04.02			
	C 220 CDI			03.01	09.07 - Sportpaket / - Sportpaket AMG			
	C 220 CDI	110		02.04	09.07 - Sportpaket / - Sportpaket AMG			
	C 230			06.05	09.07 - Sportpaket / - Sportpaket AMG			
	C 230 Kompressor			02.04	09.07 - Sportpaket / - Sportpaket AMG			
	C 240			03.01	09.07 - Sportpaket / - Sportpaket AMG			
	C 240 4-Matic			07.02	09.07			
	C 270 CDI			03.01	09.07 - Sportpaket / - Sportpaket AMG			
	C 280			06.05	09.07 - Sportpaket / - Sportpaket AMG			
C 280 4-Matic			06.05	09.07 - Sportpaket / - Sportpaket AMG				
C 320			03.01	09.07 - Sportpaket / - Sportpaket AMG				
C 320 4-Matic			07.02	09.07				
					BAR28106		300 28,0 25,4 V L	
	C 180			03.01	09.07	BAH0018	2	L=385
	C 180 Kompressor			05.02	09.07			
	C 200 CDI			03.01	09.07			
	C 200 CDI	90		04.03	09.07			
	C 200 CGI Kompressor			07.03	09.07			
	C 200 Kompressor			05.02	09.07			
	C 200 Kompressor	120		03.01	04.02			
	C 220 CDI			03.01	09.07			
	C 220 CDI	110		02.04	09.07			
	C 230			06.05	09.07			
	C 230 Kompressor			02.04	09.07			
	C 240			03.01	09.07			
	C 270 CDI			03.01	09.07			
	C 280			06.05	09.07			
	C 30 CDI AMG			01.03	09.07			
	C 32 Kompressor AMG			03.01	09.07			
	C 320			03.01	09.07			
	C 320 CDI			02.05	09.07			
	C 350			06.05	09.07			
	C 55 AMG			02.04	09.07			















1) - sports package / - pacchetto sportivo / - version Sport / - kit deportivo  
2) + sports package / + pacchetto sportivo / + version Sport / + kit deportivo



















MERCEDENZ BENZ C-Klasse (S203) Kombi (01-07)										
	C 180		03.01	09.07	BA2206 BAV1046	2			21899 15,1 /WE Warnkontakt L=95mm	ATE
	C 180 Kompressor		05.02	09.07						
	C 200 CDI	90	03.01	09.07						
	C 200 CDI		04.03	09.07						
	C 200 CGI Kompressor		07.03	09.07						
	C 200 Kompressor		05.02	09.07						
	C 200 Kompressor	120	03.01	04.02						
	C 220 CDI		03.01	09.07						
	C 220 CDI	110	02.04	09.07						
	C 230		06.05	09.07						
	C 230 Kompressor		02.04	09.07						
	C 240		03.01	09.07						
	C 240 4-Matic		07.02	09.07						
	C 270 CDI		03.01	09.07						
	C 280		06.05	09.07						
	C 280 4-Matic		06.05	09.07						
	C 320		03.01	09.07						
C 320 4-Matic		07.02	09.07							
C 320 CDI		02.05	09.07							
C 350		06.05	09.07							
C 350 4-Matic		06.05	09.07 + Sportpaket / + Sportpaket AMG							
C 30 CDI AMG		01.03	09.07	BA2163 BAV1046	2			21305 15,5 /WE Warnkontakt L=95mm	ATE	
C 32 Kompressor AMG		03.01	09.07							
C 350 4-Matic		06.05	09.07 - Sportpaket / - Sportpaket AMG							
C 55 AMG		02.04	09.07							
	C 180		03.01	09.07	BAR10217				290 10,0 8,3	
	C 180 Kompressor		05.02	09.07						
	C 200 CDI	90	03.01	09.07						
	C 200 CDI		04.03	09.07						
	C 200 CGI Kompressor		07.03	09.07						
	C 200 Kompressor		05.02	09.07						
	C 200 Kompressor	120	03.01	04.02						
	C 220 CDI		03.01	09.07						
	C 220 CDI	110	02.04	09.07						
	C 230		06.05	09.07						
	C 230 Kompressor		02.04	09.07						
	C 240		03.01	09.07						
	C 240 4-Matic		07.02	09.07						
	C 270 CDI		03.01	09.07						
	C 280		06.05	09.07						
	C 280 4-Matic		06.05	09.07						
	C 320		03.01	09.07						
C 320 4-Matic		07.02	09.07							
C 320 CDI		02.05	09.07							
C 350		06.05	09.07							
C 350 4-Matic		06.05	09.07 + Sportpaket / + Sportpaket AMG							
	C 180		03.01	09.07	BAH0006	2			L=280	
	C 180 Kompressor		05.02	09.07						
	C 200 CDI	90	03.01	09.07						
	C 200 CDI		04.03	09.07						
	C 200 CGI Kompressor		07.03	09.07						
	C 200 Kompressor		05.02	09.07						
	C 200 Kompressor	120	03.01	04.02						
	C 220 CDI		03.01	09.07						
	C 220 CDI	110	02.04	09.07						
	C 230		06.05	09.07						

1) + sports package / + pacchetto sportivo / + version Sport / + kit deportivo

2) - sports package / - pacchetto sportivo / - version Sport / - kit deportivo

									
<b>MERCEDES BENZ C-Klasse (S203) Kombi (01-07)</b>									
	C 230 Kompressor C 240 C 240 4-Matic C 270 CDI C 280 C 280 4-Matic C 30 CDI AMG C 32 Kompressor AMG C 320 C 320 4-Matic C 320 CDI C 350 C 350 4-Matic C 55 AMG		02.04 03.01 07.02 03.01 06.05 06.05 01.03 03.01 03.01 07.02 02.05 06.05 06.05 02.04	09.07 09.07 09.07 09.07 09.07 09.07 09.07 09.07 09.07 09.07 09.07 09.07 09.07 09.07		BAH0006	2		L=280
<b>MERCEDES BENZ C-Klasse (CL203) Sportcoupe (01-08)</b>									
	C 160 Kompressor C 180 C 180 Kompressor C 200 CDI C 200 CGI Kompressor C 200 Kompressor C 220 CDI C 230 Kompressor C 230 C 320 C 350 C 30 CDI AMG		04.05 03.01 05.02 07.03 07.03 03.01 03.01 03.01 06.05 09.02 06.05 09.02	05.08 05.08 05.08 05.08 05.08 05.08 05.08 05.08 05.08 05.08 05.08 05.08		BA2177 BAV1046 BA2177 BAV1046 BA2177 BAV1046 BA2184 BA2204 BAV1046	1 2 2 1 1		23144 19,8 +/WE/S LUC Warnkontakt L=95mm 23144 19,8 +/WE/S LUC Warnkontakt L=95mm 23271 17,7 /WE BRE 23745 17,7 +/WE BRE Warnkontakt L=95mm
	C 160 Kompressor C 180 C 180 Kompressor C 200 CDI C 200 CGI Kompressor C 200 Kompressor C 220 CDI C 230 C 320 C 230 Kompressor		04.05 03.01 05.02 07.03 07.03 03.01 03.01 06.05 09.02 03.01	05.08 05.08 05.08 05.08 05.08 05.08 05.08 05.08 05.08 05.08		BAR25110 BAR28106 BAR28106 BAR25110			288 25,0 22,4 V L 300 28,0 25,4 V L 300 28,0 25,4 V L 288 25,0 22,4 V L
	C 160 Kompressor C 180 C 180 Kompressor C 200 CDI C 200 CGI Kompressor C 200 Kompressor C 220 CDI C 230 C 230 Kompressor C 30 CDI AMG C 320 C 350		04.05 03.01 05.02 07.03 07.03 03.01 03.01 06.05 03.01 09.02 09.02 06.05	05.08 05.08 05.08 05.08 05.08 05.08 05.08 05.08 05.08 05.08 05.08 05.08		BAH0018	2		L=385
	C 160 Kompressor C 180 C 180 Kompressor C 200 CDI C 200 CGI Kompressor C 200 Kompressor C 220 CDI C 230 Kompressor C 230 C 30 CDI AMG C 320 C 350 C 30 CDI AMG		04.05 03.01 05.02 07.03 07.03 03.01 03.01 03.01 06.05 09.02 09.02 06.05 09.02	05.08 05.08 05.08 05.08 05.08 05.08 05.08 05.08 05.08 05.08 05.08 05.08 05.08		BA2164 BAV1046 BA2206 BA2164 BAV1046 BA2206 BAV1046 BA2163 BAV1046	1 1 1		21919 15,8 ATE Warnkontakt L=95mm 21899 15,1 /WE ATE 21919 15,8 ATE Warnkontakt L=95mm 21899 15,1 /WE ATE Warnkontakt L=95mm 21305 15,5 /WE ATE Warnkontakt L=95mm
	C 160 Kompressor C 180 C 180 Kompressor C 200 CDI C 200 CGI Kompressor C 200 Kompressor C 220 CDI C 230 C 230 Kompressor C 320 C 350 C 30 CDI AMG		04.05 03.01 05.02 07.03 07.03 03.01 03.01 06.05 03.01 09.02 06.05 09.02	05.08 05.08 05.08 05.08 05.08 05.08 05.08 05.08 05.08 05.08 05.08 05.08		BAR09114 BAR10217 BAR10217 BAR09114 BAR10217 BAR10217			278 9,0 7,3 290 10,0 8,3 290 10,0 8,3 278 9,0 7,3 290 10,0 8,3 290 10,0 8,3

									
<b>MERCEDES BENZ C-Klasse (CL203) Sportcoupe (01-08)</b>									
	C 160 Kompressor C 180 C 180 Kompressor C 200 CDI C 200 CGI Kompressor C 200 Kompressor C 220 CDI C 230 C 230 Kompressor C 30 CDI AMG C 320 C 350		04.05 03.01 05.02 07.03 07.03 03.01 03.01 06.05 03.01 09.02 09.02 06.05	05.08 05.08 05.08 05.08 05.08 05.08 05.08 05.08 05.08 05.08 05.08 05.08		BAH0006	2		L=280
<b>MERCEDES BENZ C-Klasse (CLC203) Coupe (08-10)</b>									
	CLC 160 CLC 180 Kompressor CLC 200 CDI CLC 220 CDI CLC 200 Kompressor CLC 230 CLC 350		01.09 05.08 05.08 05.08 05.08 05.08 05.08	10.10 10.10 10.10 10.10 10.10 10.10 10.10		BA2177 BAV1046 BA2177 BAV1046 BA2177 BAV1046 BAV1046	1 1 1 1 1	23144 19,8 +/WE/S Warnkontakt L=95mm 23144 19,8 +/WE/S Warnkontakt L=95mm 23144 19,8 +/WE/S Warnkontakt L=95mm Warnkontakt L=95mm	LUC LUC LUC
	CLC 160 CLC 180 Kompressor CLC 200 CDI CLC 220 CDI CLC 200 Kompressor CLC 230 CLC 350		01.09 05.08 05.08 05.08 05.08 05.08 05.08	10.10 10.10 10.10 10.10 10.10 10.10 10.10		BAR25110 BAR28106		288 25,0 22,4 V L 300 28,0 25,4 V L	
	CLC 160 CLC 180 Kompressor CLC 200 CDI CLC 200 Kompressor CLC 220 CDI CLC 230 CLC 350		01.09 05.08 05.08 05.08 05.08 05.08 05.08	10.10 10.10 10.10 10.10 10.10 10.10 10.10		BAH0018	2	L=385	
	CLC 160 CLC 180 Kompressor CLC 200 CDI CLC 220 CDI CLC 200 Kompressor CLC 230 CLC 350		01.09 05.08 05.08 05.08 05.08 05.08 05.08	10.10 10.10 10.10 10.10 10.10 10.10 10.10		BA2164 BAV1046 BA2206 BAV1046	1 1	21919 15,8 Warnkontakt L=95mm 21899 15,1 /WE Warnkontakt L=95mm	ATE ATE
	CLC 160 CLC 180 Kompressor CLC 200 CDI CLC 220 CDI CLC 200 Kompressor CLC 230 CLC 350		01.09 05.08 05.08 05.08 05.08 05.08 05.08	10.10 10.10 10.10 10.10 10.10 10.10 10.10		BAR09114 BAR09114 BAR10217		278 9,0 7,3 278 9,0 7,3 290 10,0 8,3	
	CLC 160 CLC 180 Kompressor CLC 200 CDI CLC 200 Kompressor CLC 220 CDI CLC 230 CLC 350		01.09 05.08 05.08 05.08 05.08 05.08 05.08	10.10 10.10 10.10 10.10 10.10 10.10 10.10		BAH0006	2	L=280	
<b>MERCEDES BENZ C-Klasse (W204) Limousine (07-)</b>									
	C 180 CDI C 180 CGI C 180 Kompressor C 180 Kompressor Eco C 200 CDI C 200 CGI C 200 Kompressor C 220 CDI C 230 C 230 4-Matic C 250 CDI C 250 CDI 4-matic C 250 CGI C 280 / C 300 C 280 4-matic C 300 4-Matic C 300 CDI 4-matic C 300 4-Matic C 320 CDI C 320 CDI 4-Matic C 350 C 350 4 Matic C 350 CDI C 350 CDI 4-matic C 350 CGI		01.11 04.09 03.07 01.09 03.07 04.09 03.07 03.07 03.07 07.07 10.08 01.11 04.09 03.07 07.07 04.09 01.11 07.07 03.07 07.07 03.07 07.07 04.09 10.09 09.08			BAV1046 BAV1046	1 1	Warnkontakt L=95mm Warnkontakt L=95mm	

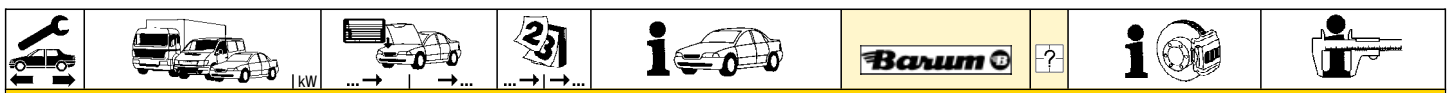

















































**MERCEDES BENZ C-Klasse (W204) Limousine (07-)**

	C 180 CDI C 180 CGI C 180 Kompressor C 180 Kompressor Eco C 200 CDI C 200 CGI C 200 Kompressor C 220 CDI C 230 C 250 CDI C 250 CGI C 280 / C 300 C 320 CDI C 350 C 350 CDI C 350 CGI	01.11 04.09 03.07 01.09 03.07 04.09 03.07 03.07 03.07 10.08 04.09 03.07 03.07 03.07 04.09 09.08	BAH0018	2	L=385
	C 180 CDI C 180 CGI C 180 Kompressor C 180 Kompressor Eco C 200 CDI C 200 CGI C 200 Kompressor C 220 CDI C 230 C 230 4-Matic C 250 CDI C 250 CDI 4-matic C 250 CGI C 280 / C 300 C 280 4-matic C 300 4-Matic C 300 CDI 4-matic C 320 CDI C 320 CDI 4-Matic C 350 C 350 4 Matic C 350 CDI C 350 CDI 4-matic C 350 CGI	01.11 04.09 03.07 01.09 03.07 04.09 03.07 03.07 03.07 03.07 07.07 10.08 01.11 04.09 03.07 07.07 04.09 01.11 03.07 07.07 03.07 07.07 04.09 10.09 09.08	BAV1046	1	Warnkontakt L=95mm

**MERCEDES BENZ C-Klasse (S204) Kombi (07-)**

	C 180 CDI BE C 180 Kompressor C 200 CDI	01.11 09.07 09.07	BAV1046	1	Warnkontakt L=95mm
	C 180 CGI C 200 CGI C 200 Kompressor C 220 CDI C 230 C 250 CDI C 250 CGI	04.09 04.09 09.07 09.07 09.07 04.09 04.09	BAV1046	1	Warnkontakt L=95mm
	C 250 CDI 4matic C 280	04.09 09.07	BAV1046	1	Warnkontakt L=95mm
	C 320 CDI C 320 CDI 4-Matic C 350 C 350 CDI C 350 CDI 4-matic C 350 CDI BlueEff.	09.07 09.07 09.07 06.11 10.09 04.09	BAV1046	1	Warnkontakt L=95mm
	C 350 CGI	06.11	BAV1046	1	Warnkontakt L=95mm
	C 180 CDI BE C 180 CGI C 180 Kompressor C 200 CDI C 200 CGI C 200 Kompressor C 220 CDI C 230 C 250 CDI C 250 CGI C 280 C 320 CDI C 350 C 350 CDI C 350 CDI BlueEff. C 350 CGI	01.11 04.09 09.07 09.07 04.09 09.07 09.07 09.07 04.09 04.09 09.07 09.07 09.07 09.07 06.11 04.09 06.11	BAH0018	2	L=385
	C 180 CGI C 180 Kompressor C 200 CDI C 200 CGI C 200 Kompressor C 220 CDI C 230 C 250 CGI C 280	04.09 09.07 09.07 04.09 09.07 09.07 09.07 04.09 09.07	BAV1046	1	Warnkontakt L=95mm
↓	↓				

								
<b>MERCEDES BENZ C-Klasse (S204) Kombi (07-)</b>								
	C 320 CDI		09.07		BAV1046	1		Warnkontakt L=95mm
	C 320 CDI 4-Matic		09.07					
	C 350		09.07					
	C 350 CDI 4-matic		10.09					
	C 350 CDI BlueEff.		04.09					
	C 180 CDI BE		01.11		BAV1046	1		Warnkontakt L=95mm
	C 350 CGI		06.11		BAV1046	1		Warnkontakt L=95mm
C 350 CDI		06.11		BAV1046	1		Warnkontakt L=95mm	
C 250 CDI		04.09		BAV1046	1		Warnkontakt L=95mm	
C 250 CDI 4matic		04.09		BAV1046	1		Warnkontakt L=95mm	
<b>MERCEDES BENZ C-Klasse (C204) Coupe (11-)</b>								
	C 180 CGI	115	06.11		BAV1046	2		Warnkontakt L=95mm
	C 220 CDI	125	06.11		BAV1046	2		Warnkontakt L=95mm
	C 250 CDI	150	06.11					
	C 250 CGI	150	06.11		BAV1046	2		Warnkontakt L=95mm
	C 350	225	06.11		BAV1046	2		Warnkontakt L=95mm
	C 180 CGI	115	06.11		BAH0018	2		L=385
	C 220 CDI	125	06.11					
	C 250 CDI	150	06.11					
	C 250 CGI	150	06.11					
	C 350	225	06.11					
	C 180 CGI	115	06.11		BAV1046	2		Warnkontakt L=95mm
	C 350	225	06.11					
	C 220 CDI	125	06.11		BAV1046	2		Warnkontakt L=95mm
	C 250 CGI	150	06.11					
	C 250 CDI	150	06.11		BAV1046	2		Warnkontakt L=95mm
C 63 AMG	336	06.11		BAV1046	2		Warnkontakt L=95mm	
<b>MERCEDES BENZ CL-Klasse (C140) Coupe (96-99)</b>								
	CL 420		06.96	02.99	BA2174	4		21303 18,8 /WE ATE Warnkontakt L=94mm
	CL 500		06.96	02.99	BAV1004			
	CL 600		06.96	02.99				
	CL 420		06.96	02.99	BAH0028	2		L=480
	CL 500		06.96	02.99				
	CL 600		06.96	02.99				
	CL 420		06.96	02.99	BA2163	4		21305 15,5 /WE ATE Warnkontakt L=94mm
	CL 500		06.96	02.99	BAV1004			
	CL 600		06.96	02.99				
	CL 420		06.96	02.99	BAH0006	2		L=280
	CL 500		06.96	02.99				
	CL 600		06.96	02.99				
<b>MERCEDES BENZ CL-Klasse (C215) Coupe (99-06)</b>								
	CL 500		03.99	08.06	BA2184	2		23271 17,7 /WE BRE Warnkontakt L=95mm
	CL 55 AMG		10.99	08.06	BAV1046			
	CL 600		03.99	08.06				
	CL 55 Kompressor AMG		06.02	08.06	BAV1046	2		Warnkontakt L=95mm
	CL 65 AMG		09.03	08.06				
	CL 500		03.99	08.06	BAR32115			330 32,0 30,0 V L
	CL 500		03.99	08.06	BAV1046	1		Warnkontakt L=95mm
	CL 55 AMG		10.99	08.06				
	CL 600		03.99	08.06				
	CL 55 Kompressor AMG		06.02	08.06	BAV1046	1		Warnkontakt L=95mm
	CL 65 AMG		09.03	08.06	BAV1046	1		Warnkontakt L=95mm
<b>MERCEDES BENZ CL-Klasse (C216) Coupe (06-)</b>								
	CL 500 BlueEfficiency		10.10		BAV1046	1		Warnkontakt L=95mm
	CL 500		07.06		BA2218	1		23334 16,1 +/-WE ATE Warnkontakt L=95mm
	CL 500 4-Matic		03.08		BAV1046			
	CL 500 BlueEfficiency		10.10		BAV1046			
	CL 600		07.06		BAV1046	1		Warnkontakt L=95mm
<b>MERCEDES BENZ CLK-Klasse (C208) Coupe (97-02)</b>								
	CLK 200		06.97	06.02	BA2150	2		21664 19,1 +/-WE ATE Warnkontakt L=94mm
	CLK 200 Kompressor		06.97	06.02	BAV1004			
	CLK 230 Kompressor		06.97	06.02				
	CLK 320		06.97	06.02	BA2168			
CLK 430		03.98	06.02 + ABS	BAV1004	2		21670 20,3 +/-WE ATE Warnkontakt L=94mm	
	CLK 430	F129678	03.98	- ABS	BA2182 BAV1004	2		21153 17,5 /WE ATE Warnkontakt L=94mm
	CLK 200		06.97	06.02	BAR25110			288 25,0 22,4 V L
	CLK 200 Kompressor		06.97	06.02				
	CLK 230 Kompressor		06.97	06.02				
	CLK 320		06.97	06.02				
CLK 430		03.98	06.02 + ABS	BAR28106			300 28,0 25,4 V L	

								
<b>MERCEDES BENZ CLK-Klasse (C208) Coupe (97-02)</b>								
	CLK 200 CLK 200 Kompressor CLK 230 Kompressor CLK 320 CLK 430 CLK 55 AMG		06.97 06.02 06.97 06.02 06.97 06.02 06.97 06.02 03.98 06.02 08.99 06.02		BAH0018	2		L=385
	CLK 200 CLK 200 Kompressor CLK 230 Kompressor		06.97 06.02 06.97 06.02 06.97 06.02		BA2164			21919 15,8 ATE
	CLK 320 CLK 430 CLK 55 AMG		06.97 06.02 03.98 06.02 08.99 06.02		BA2163 BAV1004	1		21305 15,5 /WE ATE Warnkontakt L=94mm
	CLK 200 CLK 200 Kompressor CLK 230 Kompressor		06.97 06.02 06.97 06.02 06.97 06.02		BAR09114			278 9,0 7,3
	CLK 320 CLK 430	F129678	06.97 06.02 03.98		BAR10217			290 10,0 8,3
	CLK 200 CLK 200 Kompressor CLK 230 Kompressor CLK 320 CLK 430 CLK 55 AMG		06.97 06.02 06.97 06.02 06.97 06.02 06.97 06.02 03.98 06.02 08.99 06.02		BAH0006	2		L=280
<b>MERCEDES BENZ CLK-Klasse (A208) Cabrio (98-03)</b>								
	CLK 200		06.98 06.03		BA2150 BAV1004	2		21664 19,1 +/WE ATE Warnkontakt L=94mm
	CLK 200 Kompressor CLK 230 Kompressor CLK 320		06.98 06.03 06.98 06.03 06.98 06.03		BA2168 BAV1004	2		21670 20,3 +/WE ATE Warnkontakt L=94mm
	CLK 200 CLK 200 Kompressor CLK 230 Kompressor CLK 320		06.98 06.03 06.98 06.03 06.98 06.03 06.98 06.03		BA2168 BAV1004	2		21670 20,3 +/WE ATE Warnkontakt L=94mm
	CLK 200 CLK 200 Kompressor CLK 230 Kompressor CLK 320		06.98 06.03 06.98 06.03 06.98 06.03 06.98 06.03		BAR25110 BAR28106			288 25,0 22,4 V L 300 28,0 25,4 V L
	CLK 200 CLK 200 Kompressor CLK 230 Kompressor CLK 320 CLK 430 CLK 55 AMG		06.98 06.03 06.98 06.03 06.98 06.03 06.98 06.03 06.99 06.03 01.00 06.03		BAH0018	2		L=385
	CLK 200 CLK 200 Kompressor CLK 230 Kompressor CLK 320 CLK 430 CLK 55 AMG	F 196683 / T 098095 F 196683 / T 098095 F 196683 / T 098095 F 196683 / T 098095 F 196683 / T 098095	06.98 06.98 06.98 06.99 01.00		BA2164 BA2163 BAV1004	1		21919 15,8 ATE 21305 15,5 /WE ATE Warnkontakt L=94mm
	CLK 200 Kompressor CLK 230 Kompressor CLK 320 CLK 430 CLK 55 AMG	F 196684 / T 098096 F 196684 / T 098096 F 196684 / T 098096 F 196684 / T 098096 F 196684 / T 098096	06.03 06.03 06.03 06.03 06.03		BA2206 BAV1004	1		21899 15,1 /WE ATE Warnkontakt L=94mm
	CLK 200 CLK 200 Kompressor CLK 230 Kompressor CLK 320		06.98 06.03 06.98 06.03 06.98 06.03 06.98 06.03		BAR09114 BAR10217			278 9,0 7,3 290 10,0 8,3
	CLK 200 CLK 200 Kompressor CLK 230 Kompressor CLK 320 CLK 430 CLK 55 AMG		06.98 06.03 06.98 06.03 06.98 06.03 06.98 06.03 06.99 06.03 01.00 06.03		BAH0006	2		L=280
<b>MERCEDES BENZ CLK-Klasse (C209) Coupe (02-09)</b>								
	CLK 200 CGI CLK 200 Kompressor CLK 220 CDI		09.02 04.09 09.02 04.09 05.05 04.09		BA2177 BAV1046	1		23144 19,8 +/WE/S LUC Warnkontakt L=95mm
	CLK 240 CLK 320		05.02 04.09 05.02 04.09		BA2177 BAV1046	2		23144 19,8 +/WE/S LUC Warnkontakt L=95mm
	CLK 200 Kompressor CLK 270 CDI CLK 280		10.06 04.09 10.02 04.09 05.05 04.09		BA2177 BAV1046	1 	- Sportpaket 1)	23144 19,8 +/WE/S LUC Warnkontakt L=95mm
	CLK 320 CDI CLK 350		05.05 04.09 05.05 04.09		BA2184 BA2204 BAV1046	1 	+ Sportpaket 2)	23271 17,7 /WE BRE 23745 17,7 +/WE BRE Warnkontakt L=95mm
	CLK 500 CLK 55 AMG		05.02 04.09 09.02 04.09		BA2184 BA2204 BAV1046	1 		23271 17,7 /WE BRE 23745 17,7 +/WE BRE Warnkontakt L=95mm
	CLK 200 CGI CLK 220 CDI		09.02 04.09 05.05 04.09		BAR25110		- Sportpaket 1)	288 25,0 22,4 V L
	CLK 240 CLK 320		05.02 04.09 05.02 04.09		BAR28106			300 28,0 25,4 V L

1) - sports package / - pacchetto sportivo / - version Sport / - kit deportivo

2) + sports package / + pacchetto sportivo / + version Sport / + kit deportivo

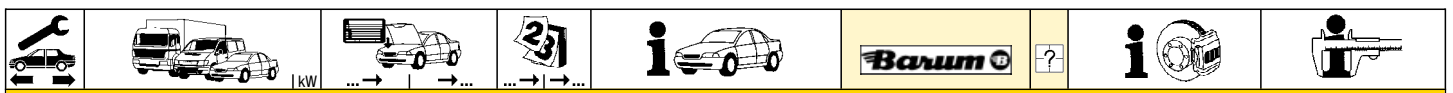





















**MERCEDES BENZ CLK-Klasse (C209) Coupe (02-09)**

	CLK 200 Kompressor CLK 270 CDI CLK 280	10.06 04.09 10.02 04.09 05.05 04.09	BAR28106	- Sportpaket <sup>1)</sup>	300 28,0 25,4 V L
	CLK 200 CGI CLK 200 Kompressor CLK 220 CDI CLK 240 CLK 270 CDI CLK 280 CLK 320 CLK 320 CDI CLK 350 CLK 500 CLK 55 AMG CLK 63 AMG	09.02 04.09 09.02 04.09 05.05 04.09 05.02 04.09 10.02 04.09 05.05 04.09 05.02 04.09 05.05 04.09 05.05 04.09 05.02 04.09 09.02 04.09 04.06 04.09	BAH0018	2	L=385
	CLK 200 CGI CLK 200 Kompressor CLK 220 CDI	09.02 04.09 09.02 04.09 05.05 04.09	BA2164		21919 15,8 ATE
	CLK 240 CLK 270 CDI CLK 280 CLK 320 CLK 320 CDI CLK 350	05.02 04.09 10.02 04.09 05.05 04.09 05.02 04.09 05.05 04.09 05.05 04.09	BA2206 BAV1046	1	21899 15,1 /WE ATE Warnkontakt L=95mm
	CLK 500 CLK 55 AMG	05.02 04.09 09.02 04.09	BAV1046 BA2163 BAV1046	1 1	Warnkontakt L=95mm 21305 15,5 /WE ATE Warnkontakt L=95mm
	CLK 63 AMG	04.06 04.09	BAV1046	1	Warnkontakt L=95mm
	CLK 200 CGI CLK 200 Kompressor CLK 220 CDI	09.02 04.09 09.02 04.09 05.05 04.09	BAR09114		278 9,0 7,3
	CLK 240 CLK 270 CDI CLK 280 CLK 320 CLK 320 CDI CLK 350	05.02 04.09 10.02 04.09 05.05 04.09 05.02 04.09 05.05 04.09 05.05 04.09	BAR10217		290 10,0 8,3
	CLK 200 CGI CLK 200 Kompressor CLK 220 CDI CLK 240 CLK 270 CDI CLK 280 CLK 320 CLK 320 CDI CLK 350 CLK 500 CLK 55 AMG CLK 63 AMG	09.02 04.09 09.02 04.09 05.05 04.09 05.02 04.09 10.02 04.09 05.05 04.09 05.02 04.09 05.05 04.09 05.05 04.09 05.02 04.09 09.02 04.09 04.06 04.09	BAH0006	2	L=280

**MERCEDES BENZ CLK-Klasse (A209) Cabrio (03-09)**

	CLK 200 CGI	05.03 12.09	BA2177 BAV1046	1	23144 19,8 +/WE/S LUC Warnkontakt L=95mm
	CLK 240 CLK 320	05.03 12.09 05.03 12.09	BA2177 BAV1046	2	23144 19,8 +/WE/S LUC Warnkontakt L=95mm
	CLK 200 Kompressor CLK 280	05.03 12.09 05.05 12.09	BA2177 BAV1046	1	23144 19,8 +/WE/S LUC Warnkontakt L=95mm
	CLK 320 CDI CLK 350	05.05 12.09 05.05 12.09	BA2184 BA2204 BAV1023 BAV1046	1 1	+ Sportpaket <sup>2)</sup> 23271 17,7 /WE BRE 23745 17,7 +/WE BRE Warnkontakt L=101mm Warnkontakt L=95mm
	CLK 500 CLK 55 AMG	05.03 12.09 05.03 12.09	BA2184 BA2204 BAV1046	1	23271 17,7 /WE BRE 23745 17,7 +/WE BRE Warnkontakt L=95mm
	CLK 200 CGI	05.03 12.09	BAR25110		288 25,0 22,4 V L
	CLK 240 CLK 320	05.03 12.09 05.03 12.09	BAR28106		300 28,0 25,4 V L
	CLK 200 Kompressor CLK 280	05.03 12.09 05.05 12.09	BAR28106	- Sportpaket <sup>1)</sup>	300 28,0 25,4 V L
	CLK 200 CGI CLK 200 Kompressor CLK 240 CLK 280 CLK 320 CLK 320 CDI CLK 350 CLK 500 CLK 55 AMG CLK 63 AMG	05.03 12.09 05.03 12.09 05.03 12.09 05.05 12.09 05.03 12.09 05.05 12.09 05.05 12.09 05.03 12.09 05.03 12.09 04.06 12.09	BAH0018	2	L=385
	CLK 200 CGI CLK 200 Kompressor	05.03 12.09 05.03 12.09	BA2164		21919 15,8 ATE
	CLK 240 CLK 280 CLK 320	05.03 12.09 05.05 12.09 05.03 12.09	BA2206 BAV1046	1	21899 15,1 /WE ATE Warnkontakt L=95mm

<sup>1)</sup> - sports package / - pacchetto sportivo / - version Sport / - kit deportivo  
<sup>2)</sup> + sports package / + pacchetto sportivo / + version Sport / + kit deportivo

								
<b>MERCEDES BENZ CLK-Klasse (A209) Cabrio (03-09)</b>								
	CLK 320 CDI		05.05	12.09	BA2206			21899 15,1 /WE ATE
	CLK 350		05.05	12.09	BAV1046	1		Warnkontakt L=95mm
	CLK 500		05.03	12.09	BAV1046	1		Warnkontakt L=95mm
	CLK 55 AMG		05.03	12.09	BA2163 BAV1046	1		21305 15,5 /WE ATE Warnkontakt L=95mm
	CLK 63 AMG		04.06	12.09	BAV1046	1		Warnkontakt L=95mm
	CLK 200 CGI		05.03	12.09	BAR09114			278 9,0 7,3
	CLK 200 Kompressor		05.03	12.09				
	CLK 240		05.03	12.09	BAR10217			290 10,0 8,3
	CLK 280		05.05	12.09				
	CLK 320		05.03	12.09				
	CLK 320 CDI CLK 350		05.05 05.05	12.09 12.09				
	CLK 200 CGI		05.03	12.09	BAH0006	2		L=280
	CLK 200 Kompressor		05.03	12.09				
	CLK 240		05.03	12.09				
	CLK 280		05.05	12.09				
	CLK 320		05.03	12.09				
	CLK 320 CDI		05.05	12.09				
	CLK 350		05.05	12.09				
	CLK 500		05.03	12.09				
	CLK 55 AMG		05.03	12.09				
	CLK 63 AMG		04.06	12.09				
<b>MERCEDES BENZ CLS-Klasse (C219) Coupe (04-10)</b>								
	CLS 280 / CLS 300		10.07	10.10	BA2184 BA2204 BAV1046	1	☐	23271 17,7 /WE BRE 23745 17,7 +/WE BRE Warnkontakt L=95mm
	CLS 320 CDI		05.05	10.10	BA2184			23271 17,7 /WE BRE
	CLS 350		08.04	10.10	BA2204			23745 17,7 +/WE BRE
	CLS 350 CDI		04.09	10.10	BAV1046	2		Warnkontakt L=95mm
	CLS 350 CGI		04.06	10.10				
	CLS 500	225	08.04	10.10	BA2184 BA2204 BAV1023 BAV1046	1	☐	23271 17,7 /WE BRE 23745 17,7 +/WE BRE Warnkontakt L=101mm Warnkontakt L=95mm
	CLS 55 AMG		01.05	10.10	BAV1023 BAV1046	1	☐	Warnkontakt L=101mm Warnkontakt L=95mm
	CLS 320 CDI		05.05	10.10	BAR28142			312 28,0 25,4 V L
	CLS 280 / CLS 300		10.07	10.10	BA2218	1		23334 16,1 +/WE ATE
	CLS 320 CDI		05.05	10.10	BAV1046			Warnkontakt L=95mm
	CLS 350		08.04	10.10				
	CLS 350 CDI		04.09	10.10				
	CLS 350 CGI		04.06	10.10				
	CLS 500	225	08.04	10.10				
	CLS 500	285	04.06	10.10				
	CLS 55 AMG		01.05	10.10	BAV1046	1		Warnkontakt L=95mm
<b>MERCEDES BENZ CLS-Klasse (C218) Coupe (10-)</b>								
	CLS 250 CDI	150	11.10		BAV1046	1		Warnkontakt L=95mm
	CLS 350 CDI	195	11.10					
	CLS 350 CGI	225	11.10					
	CLS 350 CDI 4matic	195	09.11		BAV1046	1		Warnkontakt L=95mm
	CLS 500	300	11.10		BAV1046	1		Warnkontakt L=95mm
	CLS 500 4matic	300	11.10					
	CLS 250 CDI	150	11.10		BAV1046	1		Warnkontakt L=95mm
	CLS 350 CDI	195	11.10					
	CLS 350 CDI 4matic	195	09.11					
	CLS 350 CGI	225	11.10					
	CLS 500	300	11.10					
	CLS 500 4matic	300	11.10					
	CLS 250 CDI	150	11.10		BAR10278			300 10,0 8,3
<b>MERCEDES BENZ CLS-Klasse (X218) Shooting Brake (12-)</b>								
	CLS 350	225	09.12		BAV1046	1		Warnkontakt L=95mm
	CLS 350 CDI	195	09.12					
	CLS 350 CDI 4matic	195	09.12					
	CLS 500	300	09.12		BAV1046	1		Warnkontakt L=95mm
	CLS 500 4matic	300	09.12					
<b>MERCEDES BENZ E-Klasse (W124) (93-97)</b>								
	E 200 Cabrio		07.93	06.97	BA2029	2		20941 19,3 /WE/S LUC
	E 200 Coupe		07.93	06.96	BAV1001			Warnkontakt L=68(170)mm
	E 200 D		07.93	06.95				
	E 200 Lim.		07.93	06.95				
	E 220 Cabrio		07.93	06.97				
	E 220 Coupe		07.93	06.96				
	E 220 Lim.		07.93	06.95				
	E 250 D Lim.		07.93	06.95				
	E 250 TD Lim.		07.93	06.95				
	↓	↓						



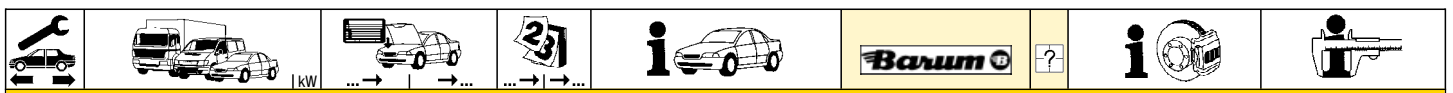



























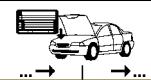

**MERCEDES BENZ E-Klasse (W124) (93-97)**

	E 280	07.93	06.95 + langer Radstand <sup>1)</sup>	BA2029 BAV1001	2	20941 19,3 /WE/S Warnkontakt L=68(170)mm	LUC			
	E 300 4-Matic Lim.	07.93	06.95							
	E 300 D Lim.	07.93	06.95							
	E 300 TD 4-Matic Lim.	07.93	06.95							
E 300 TD Lim.	07.93	06.95								
	E 200 Kombi	07.93	05.96	BA2029 BAV1001	2	20941 19,3 /WE/S Warnkontakt L=68(170)mm	LUC			
	E 220 Kombi	07.93	05.96							
	E 250 D Kombi	07.93	05.96							
	E 250 TD Kombi	07.93	05.96							
	E 280 Kombi	07.93	05.96							
	E 300 4-Matic Kombi	07.93	05.96							
	E 300 D Kombi	07.93	05.96							
	E 300 TD 4-Matic Komb	07.93	05.96							
	E 300 TD Kombi	07.93	05.96							
	E 280	07.93	06.95 + langer Radstand <sup>2)</sup>					BAV1004	4	Warnkontakt L=94mm
E 320	07.93	06.97								
E 36 AMG	05.94	06.96								
	E 420	07.93	06.95	BA2182 BAV1004	4	21153 17,5 /WE Warnkontakt L=94mm	ATE			
	E 500	07.93	06.95							
	E 60 AMG	05.94	06.95							
	E 200 D	07.93	06.95	BAR12117		284 12,0 10,0 L				
	E 250 D	07.93	06.95 + kurzer Radstand <sup>1)</sup>							
	E 200	07.93	06.97	BAH0009	2	L=340				
	E 200 D	07.93	06.95							
	E 220	07.93	06.97							
	E 250 D	07.93	05.96							
	E 250 TD	07.93	05.96							
	E 280	07.93	05.96							
	E 300 D	07.93	05.96							
	E 300 TD	07.93	05.96							
	E 320	07.93	06.97							
	E 36 AMG	05.94	06.96							
	E 420	07.93	06.95							
	E 500	07.93	06.95							
	E 60 AMG	05.94	06.95							
		E 200 Coupe	07.93					06.96	BA2094	
E 200 D		07.93	06.95							
E 200 Lim.		07.93	06.95							
E 220 Coupe		07.93	06.96							
E 220 Lim.		07.93	06.95							
E 250 D		07.93	06.95 + kurzer Radstand <sup>1)</sup>							
E 250 TD Lim.		07.93	06.95							
E 280		07.93	06.95 - ASR/ + kurzer Radstand							
E 300 4-Matic Lim.		07.93	06.95							
E 300 D Lim.		07.93	06.95							
E 300 TD 4-Matic Lim.		07.93	06.95							
E 300 TD Lim.		07.93	06.95							
E 280		07.93	06.95 + ASR/ + langer Radstand	BAV1004	4	Warnkontakt L=94mm				
E 200 Cabrio	07.93	06.97								
E 200 Kombi	07.93	05.96	BA2161 BAV1004	4	21197 15,0 /WE Warnkontakt L=94mm	ATE				
E 220 Cabrio	07.93	06.97								
E 220 Kombi	07.93	05.96	BA2161 BAV1004	4	21197 15,0 /WE Warnkontakt L=94mm	ATE				
E 250 D	07.93	05.96 + langer Radstand <sup>2)</sup>								
E 250 D Kombi	07.93	05.96								
E 250 TD Kombi	07.93	05.96								
E 280	07.93	06.96								
E 280 Kombi	07.93	05.96								
E 300 4-Matic Kombi	07.93	05.96								
E 300 D Kombi	07.93	05.96								
E 300 TD 4-Matic Komb	07.93	05.96								
E 300 TD Kombi	07.93	05.96								
E 320	07.93	06.96								
E 36 AMG	05.94	06.96								
E 420	07.93	06.95								
E 500	07.93	06.95					BA2163 BAV1004	4	21305 15,5 /WE Warnkontakt L=94mm	ATE
E 60 AMG	05.94	06.95								
	E 200 Coupe	07.93					06.96	BAR09118		258 9,0 7,3
	E 200 D	07.93	06.95							
	E 200 Lim.	07.93	06.95							
	E 220 Coupe	07.93	06.96							
	E 220 Lim.	07.93	06.95							
	E 250 D	07.93	06.95 + kurzer Radstand <sup>1)</sup>							
	E 250 TD Lim.	07.93	06.95							
	E 280	07.93	06.95 + kurzer Radstand <sup>1)</sup>							
	E 300 4-Matic Lim.	07.93	06.95							
	E 300 D Lim.	07.93	06.95							
	E 300 TD 4-Matic Lim.	07.93	06.95							
	E 300 TD Lim.	07.93	06.95							
	E 200 Cabrio	07.93	06.97	BAR09114		278 9,0 7,3				
E 200 Kombi	07.93	05.96								
E 220 Cabrio	07.93	06.97								
E 220 Kombi	07.93	05.96								
E 250 D	07.93	06.95 + langer Radstand <sup>2)</sup>								

<sup>1)</sup> + short wheel base / + passo lungo / + empattement court / + distancia corta entre ejes

<sup>2)</sup> + long wheel base / + passo lungo / + empattement long / + distancia larga entre ejes



								
<b>MERCEDES BENZ E-Klasse (W124) (93-97)</b>								
	E 250 D Kombi E 250 TD Kombi E 280 Kombi E 300 4-Matic Kombi E 300 D Kombi E 300 TD 4-Matic Komb E 300 TD Kombi E 320 Cabrio E 320 Coupe E 320 Lim. E 36 AMG Cabrio E 36 AMG Coupe E 36 AMG Lim.		07.93 07.93 07.93 07.93 07.93 07.93 07.93 07.93 07.93 07.93 05.94 05.94 05.94	05.96 05.96 06.96 05.96 05.96 05.96 05.96 06.97 06.96 06.95 06.96 06.96 06.95		BAR09114		278 9,0 7,3
	E 320 Kombi E 36 AMG Kombi		03.95 03.95	05.96 05.96		BAR10217		290 10,0 8,3
	E 200 E 200 D E 220 E 250 D E 250 TD E 280 E 300 4-Matic E 300 D E 300 TD E 300 TD 4-Matic E 320 E 36 AMG E 420 E 500 E 60 AMG		07.93 07.93 07.93 07.93 07.93 07.93 07.93 07.93 07.93 07.93 07.93 05.94 07.93 07.93 05.94	06.97 06.95 06.97 05.96 05.96 05.96 05.96 05.96 05.96 05.96 05.96 06.96 06.95 06.95 06.95		BAH0004	2	L=280
<b>MERCEDES BENZ E-Klasse (W210) Limousine (95-02)</b>								
	E 200 E 200 CDI E 200 D E 200 Kompressor E 220 CDI E 220 D E 230 E 240 E 250 D E 250 D E 250 TD E 290 TD E 300 D	120	06.95 07.98 10.96 08.00 07.98 06.95 06.95 09.97 06.95 06.95 09.97 01.96 06.95	04.02 04.02 04.02 + P 04.02 04.02 06.98 08.97 04.02 - ESP 04.02 + I 04.02 04.02 04.02		BA2150 BAV1004	2	21664 19,1 +/WE ATE Warnkontakt L=94mm
	E 200 Kompressor E 240 E 270 CDI E 280 E 280 4-Matic E 300 TD E 320 E 320 4-Matic E 320 CDI	137	09.97 09.97 07.99 01.96 10.96 10.96 06.95 06.97 07.99	04.02 04.02 + ESP 04.02 04.02 04.02 04.02 04.02 04.02 04.02		BA2168 BAV1004	2	21670 20,3 +/WE ATE Warnkontakt L=94mm
	E 420 E 430		A 962231 / X 027613 01.96 A 962231 / X 027613 09.97			BA2182 BAV1004	2	21153 17,5 /WE ATE Warnkontakt L=94mm
	E 200 E 200 CDI E 200 D E 200 Kompressor E 220 CDI E 220 D E 230 E 240 E 250 D E 250 D E 250 TD E 290 TD E 300 D	120	06.95 07.98 10.96 08.00 07.98 06.95 06.95 09.97 06.95 06.95 09.97 01.96 06.95	04.02 04.02 04.02 + P 04.02 04.02 06.98 08.97 04.02 04.02 + I 04.02 04.02 04.02		BAR25110		288 25,0 22,4 V L
	E 200 Kompressor E 270 CDI E 280 E 280 4-Matic E 300 TD E 320 E 320 4-Matic E 320 CDI	137	09.97 07.99 01.96 10.96 10.96 06.95 06.97 07.99	04.02 04.02 04.02 04.02 04.02 04.02 04.02 04.02		BAR28106		300 28,0 25,4 V L
	E 200 E 200 CDI E 200 D E 200 Kompressor E 220 CDI E 220 D E 230 E 240 E 250 D		06.95 07.98 10.96 09.97 07.98 06.95 06.95 09.97 06.95	04.02 04.02 04.02 + P 04.02 04.02 06.98 08.97 04.02 04.02 + I		BAH0018	2	L=385
								

								
<b>MERCEDES BENZ E-Klasse (W210) Limousine (95-02)</b>								
	E 250 D E 250 TD E 270 CDI E 280 E 290 TD E 300 D E 300 TD E 320 E 320 CDI E 420 E 430 E 50 AMG E 55 AMG		06.95 04.02 09.97 04.02 07.99 04.02 01.96 04.02 01.96 04.02 06.95 04.02 10.96 04.02 06.95 04.02 07.99 04.02 01.96 08.97 09.97 04.02 01.96 08.97 09.97 04.02		BAH0018	2		L=385
	E 280 4-Matic E 320 4-Matic E 430 4-Matic		10.96 04.02 06.97 04.02 05.99 04.02		BAH0006	2		L=280
	E 200 E 200 D E 220 D E 230 E 240 E 250 D E 250 D E 290 TD E 300 D		A379346 06.95 A379346 10.96 A379346 06.95 A379346 06.95 A379346 09.97 A379346 06.95 A379346 06.95 A379346 01.96 A379346 06.95	+ P     + I	BA2161 BAV1004	2		21197 15,0 /WE Warnkontakt L=94mm ATE
	E 200 E 200 CDI E 200 D E 200 Kompressor E 220 CDI E 220 D E 230 E 240 E 250 D E 250 D E 250 TD E 290 TD E 300 D	A379347 A379347 120 A379347 A379347 A379347 A379347 A379347 A379347 A379347	04.02 07.98 04.02 04.02 + P 08.00 04.02 07.98 04.02 06.98 08.97 04.02 04.02 + I 04.02 09.97 04.02 04.02 04.02		BA2164			21919 15,8 ATE
	E 280 E 280 4-Matic E 300 TD E 320 E 320 4-Matic E 420 E 430 E 55 AMG	A379346 A379346 A379346 A379346 A379346 A379346 A379346	01.96 10.96 10.96 06.95 06.97 01.96 09.97 04.02		BA2163 BAV1004	2		21305 15,5 /WE Warnkontakt L=94mm ATE
	E 200 Kompressor E 270 CDI E 280 E 280 4-Matic E 300 TD E 320 E 320 4-Matic E 320 CDI E 420 E 430	137 A379347 A379347 A379347 A379347 A379347 A379347 A379347	09.97 04.02 07.99 04.02 04.02 04.02 04.02 04.02 04.02 07.99 04.02 08.97 04.02		BA2206 BAV1004	2		21899 15,1 /WE Warnkontakt L=94mm ATE
	E 430 4-Matic E 50 AMG		05.99 04.02 01.96 08.97		BA2163 BAV1004	2		21305 15,5 /WE Warnkontakt L=94mm ATE
	E 200 E 200 CDI E 200 D E 200 Kompressor E 220 CDI E 220 D E 230 E 240 E 250 D E 250 D E 250 TD E 290 TD E 300 D		06.95 04.02 07.98 04.02 10.96 04.02 + P 08.00 04.02 07.98 04.02 06.95 06.98 06.95 08.97 09.97 04.02 06.95 04.02 + I 06.95 04.02 09.97 04.02 01.96 04.02 06.95 04.02		BAR09114	2		278 9,0 7,3
	E 200 Kompressor E 270 CDI E 280 E 280 4-Matic E 300 TD E 320 E 320 4-Matic E 320 CDI E 420 E 430	137	09.97 04.02 07.99 04.02 01.96 04.02 10.96 04.02 10.96 04.02 06.95 04.02 06.97 04.02 07.99 04.02 01.96 08.97 09.97 04.02		BAR10217			290 10,0 8,3

**MERCEDES BENZ E-Klasse (W210) Limousine (95-02)**

	E 200 E 200 CDI E 200 D E 200 Kompressor E 220 CDI E 220 D E 230 E 240 E 250 D E 250 D E 250 TD E 270 CDI E 280 E 290 TD E 300 D E 300 TD E 320 E 320 CDI E 420 E 430 E 50 AMG E 55 AMG			06.95 04.02 07.98 04.02 10.96 04.02 + P 09.97 04.02 07.98 04.02 06.95 06.98 06.95 08.97 09.97 04.02 06.95 04.02 + I 06.95 04.02 09.97 04.02 07.99 04.02 01.96 04.02 01.96 04.02 06.95 04.02 10.96 04.02 06.95 04.02 07.99 04.02 01.96 08.97 09.97 04.02 01.96 08.97 09.97 04.02	BAH0006	2		L=280
	E 280 4-Matic E 320 4-Matic E 430 4-Matic			10.96 04.02 06.97 04.02 05.99 04.02	BAH0006	2		L=280

**MERCEDES BENZ E-Klasse (S210) Kombi (96-03)**

	E 200 E 200 Kompressor E 220 CDI E 230 E 240 E 250 D E 250 D E 250 TD E 290 TD	120		05.96 04.03 08.00 04.03 07.98 04.03 + Radstand 2833mm <sup>1)</sup> 05.96 08.97 09.97 04.03 05.96 04.03 + I / + Radstand 2833mm <sup>2)</sup> 05.96 04.03 + Radstand 2833mm <sup>1)</sup> 09.97 04.03 05.96 04.03 + Radstand 2833mm <sup>1)</sup>	BA2150 BAV1004	2		21664 19,1 +/-WE Warnkontakt L=94mm	ATE
	E 200 Kompressor E 220 CDI E 250 D E 270 CDI E 280 E 280 4-Matic E 290 TD E 300 TD E 320 E 320 4-Matic E 320 CDI	137		09.97 04.03 07.98 04.03 + Radstand 3570mm <sup>3)</sup> 05.96 04.03 + Radstand 3570mm <sup>3)</sup> 07.99 04.03 10.96 04.03 + Radstand 3570mm <sup>3)</sup> 10.96 04.03 05.96 04.03 + Radstand 3570mm <sup>3)</sup> 10.96 04.03 06.97 04.03 07.99 04.03	BA2168 BAV1004	2		21670 20,3 +/-WE Warnkontakt L=94mm	ATE
	E 420 E 430		A 962231 / X 027613 A 962231 / X 027613	05.96 09.97	BA2182 BAV1004	2		21153 17,5 /WE Warnkontakt L=94mm	ATE
	E 200 E 200 Kompressor E 220 CDI E 230 E 240 E 250 D E 250 D E 250 TD E 290 TD	120		05.96 04.03 08.00 04.03 07.98 04.03 + Radstand 2833mm <sup>1)</sup> 05.96 08.97 09.97 04.03 05.96 04.03 + I / + Radstand 2833mm <sup>2)</sup> 05.96 04.03 + Radstand 2833mm <sup>1)</sup> 09.97 04.03 05.96 04.03 + Radstand 2833mm <sup>1)</sup>	BAR25110			288 25,0 22,4 V L	
	E 200 Kompressor E 220 CDI E 250 D E 270 CDI E 280 E 280 4-Matic E 290 TD E 300 TD E 320 E 320 4-Matic E 320 CDI	137		09.97 04.03 07.98 04.03 + Radstand 3570mm <sup>3)</sup> 05.96 04.03 + Radstand 3570mm <sup>3)</sup> 07.99 04.03 10.96 04.03 + Radstand 3570mm <sup>3)</sup> 10.96 04.03 05.96 04.03 + Radstand 3570mm <sup>3)</sup> 10.96 04.03 06.97 04.03 07.99 04.03	BAR28106			300 28,0 25,4 V L	
	E 200 E 200 Kompressor E 220 CDI E 230 E 240 E 250 D E 250 D E 250 D E 250 TD E 270 CDI E 280 E 290 TD E 300 TD E 320 E 320 CDI E 420 E 430 E 55 AMG			05.96 04.03 09.97 04.03 07.98 04.03 05.96 08.97 09.97 04.03 05.96 04.03 + I / + Radstand 2833mm <sup>2)</sup> 05.96 04.03 + Radstand 2833mm <sup>1)</sup> 05.96 04.03 + Radstand 3570mm <sup>3)</sup> 09.97 04.03 07.99 04.03 10.96 04.03 + Radstand 3570mm <sup>3)</sup> 05.96 04.03 10.96 04.03 10.96 04.03 07.99 04.03 05.96 08.97 09.97 04.03 09.97 04.03	BAH0018	2		L=385	

1) + wheel base 2833 mm / + passo 2833 mm / + empattement 2833 mm / + distancia entre ejes 2833 mm  
 2) + I / + wheel base 2833mm / + I / + passo 2833mm / + I / + empattement 2833mm / + I / + dist.entre ejes 2833mm  
 3) + wheel base 3570 mm / + passo 3570 mm / + empattement 3570 mm / + distancia entre ejes 3570 mm

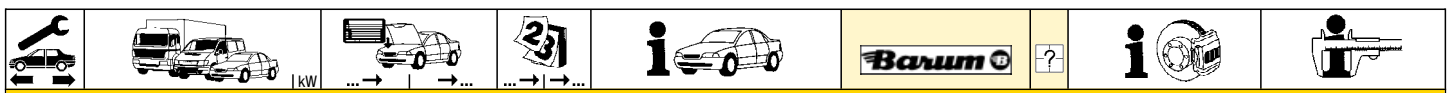

**MERCEDES BENZ E-Klasse (S210) Kombi (96-03)**

	E 280 4-Matic E 320 4-Matic E 430 4-Matic		10.96 04.03 06.97 04.03 05.99 04.03		BAH0006	2	L=280	
	E 200 E 200 Kompressor E 220 CDI E 230 E 240 E 250 D E 250 D E 250 D E 250 TD E 270 CDI E 280 E 280 4-Matic E 290 TD E 300 TD E 320 E 320 4-Matic E 320 CDI E 420 E 430 E 430 4-Matic E 55 AMG		05.96 04.03 09.97 04.03 07.98 04.03 05.96 08.97 09.97 04.03 05.96 04.03 + Ⓢ / + Radstand 2833mm <sup>1)</sup> 05.96 04.03 + Radstand 2833mm <sup>2)</sup> 05.96 04.03 + Radstand 3570mm <sup>3)</sup> 09.97 04.03 07.99 04.03 10.96 04.03 + Radstand 3570mm <sup>3)</sup> 10.96 04.03 05.96 04.03 10.96 04.03 10.96 04.03 06.97 04.03 07.99 04.03 05.96 08.97 09.97 04.03 05.99 04.03 09.97 04.03		BA2163 BAV1004	2	21305 15,5 /WE Warnkontakt L=94mm	ATE
	E 200 E 220 CDI E 230 E 250 D E 250 D E 250 D E 290 TD E 420		05.96 04.03 07.98 04.03 05.96 08.97 05.96 04.03 + Ⓢ / + Radstand 2833mm <sup>1)</sup> 05.96 04.03 + Radstand 2833mm <sup>2)</sup> 05.96 04.03 + Radstand 3570mm <sup>3)</sup> 05.96 04.03 05.96 08.97		BAR12149		290 12,0 10,3	
	E 200 Kompressor E 240 E 250 TD E 270 CDI E 280 E 280 4-Matic E 300 TD E 320 E 320 4-Matic E 320 CDI E 430		09.97 04.03 09.97 04.03 09.97 04.03 07.99 04.03 10.96 04.03 + Radstand 3570mm <sup>3)</sup> 10.96 04.03 10.96 04.03 06.97 04.03 07.99 04.03 09.97 04.03		BAR12149		290 12,0 10,3	
	E 200 E 200 Kompressor E 220 CDI E 230 E 240 E 250 D E 250 D E 250 D E 250 TD E 270 CDI E 280 E 290 TD E 300 TD E 320 E 320 CDI E 420 E 430 E 55 AMG		05.96 04.03 09.97 04.03 07.98 04.03 05.96 08.97 09.97 04.03 05.96 04.03 + Ⓢ / + Radstand 2833mm <sup>1)</sup> 05.96 04.03 + Radstand 2833mm <sup>2)</sup> 05.96 04.03 + Radstand 3570mm <sup>3)</sup> 09.97 04.03 07.99 04.03 10.96 04.03 + Radstand 3570mm <sup>3)</sup> 05.96 04.03 10.96 04.03 10.96 04.03 06.97 04.03 07.99 04.03 05.96 08.97 09.97 04.03 09.97 04.03		BAH0006	2	L=280	
	E 280 4-Matic E 320 4-Matic E 430 4-Matic		10.96 04.03 06.97 04.03 05.99 04.03		BAH0006	2	L=280	

**MERCEDES BENZ E-Klasse (W211) Limousine (02-09)**

	E 200 CDI E 200 Kompressor E 220 CDI E 230 E 240 E 270 CDI E 280 E 280 CDI E 320		05.02 02.09 05.02 02.09 03.02 02.09 04.06 02.09 03.02 02.09 03.02 02.09 05.05 02.09 05.04 02.09 - Sportpaket / - Sportpaket AMG 03.02 02.09		BA2221 BAV1023 BAV1046	1 1	23743 20,1 +/WE/S Warnkontakt L=101mm Warnkontakt L=95mm	BOS
	E 320 CDI		11.02 02.09		BA2221 BAV1023 BAV1046	1 1	23743 20,1 +/WE/S Warnkontakt L=101mm Warnkontakt L=95mm	BOS
	E 280 CDI		05.04 02.09 + Sportpaket / + Sportpaket AMG		BA2184 BA2204 BAV1046	1	23271 17,7 /WE 23745 17,7 +/WE Warnkontakt L=95mm	BRE BRE
	E 300 Bluetec E 320		09.07 02.09 03.02 02.09		BA2184 BA2204 BAV1046	1	23271 17,7 /WE 23745 17,7 +/WE Warnkontakt L=95mm	BRE BRE

1) + Ⓢ / + wheel base 2833mm / + Ⓢ / + passo 2833mm / + Ⓢ / + empattement 2833mm / + Ⓢ / + dist.entre ejes 2833mm

2) + wheel base 2833 mm / + passo 2833 mm / + empattement 2833 mm / + distancia entre ejes 2833 mm



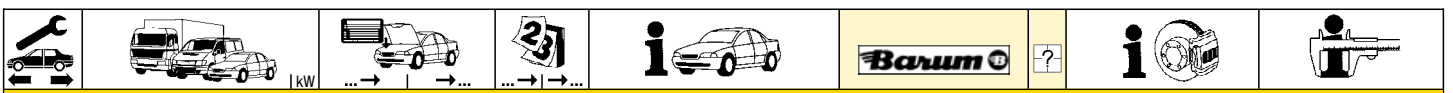











3) + wheel base 3570 mm / + passo 3570 mm / + empattement 3570 mm / + distancia entre ejes 3570 mm



**MERCEDES BENZ E-Klasse (W211) Limousine (02-09)**

	E 320 CDI		11.02	02.09		BA2184 BA2204 BAV1023 BAV1046	1	23271 17,7 /WE 23745 17,7 +/WE Warnkontakt L=101mm	<b>BRE</b> <b>BRE</b>
	E 350		12.04	02.09		BA2184 BA2204 BAV1023 BAV1046	1	23271 17,7 /WE 23745 17,7 +/WE Warnkontakt L=101mm	<b>BRE</b> <b>BRE</b>
	E 350 4-Matic		12.04	02.09					
	E 350 CGI		09.07	02.09					
	E 400 CDI		03.03	02.09					
	E 420 CDI		01.06	02.09					
	E 420 CDI		01.06	02.09		BA2184 BA2204 BAV1023 BAV1046	1 1	23271 17,7 /WE 23745 17,7 +/WE Warnkontakt L=101mm	<b>BRE</b> <b>BRE</b>
	E 500		03.02	02.09		BA2184 BA2204 BAV1023 BAV1046	1 1	23271 17,7 /WE 23745 17,7 +/WE Warnkontakt L=101mm	<b>BRE</b> <b>BRE</b>
	E 500 4-Matic		10.03	02.09					
	E 240 4-Matic		03.03	02.09		BAV1023 BAV1046	1 1	Warnkontakt L=101mm Warnkontakt L=95mm	
	E 280 4-Matic		05.05	02.09					
	E 280 CDI 4-Matic		05.05	02.09					
	E 320 4-Matic		03.03	02.09					
	E 320 CDI 4-Matic		05.05	02.09					
	E 55 Kompressor AMG		10.02	02.09		BAV1046	2	Warnkontakt L=95mm	
	E 200 CDI		05.02	02.09		BAR28141		- Taxi	295 28,0 25,4 V L
	E 200 Kompressor		05.02	02.09		BAR28176		+ Taxi	295 28,0 25,4 V L
	E 220 CDI		03.02	02.09					
	E 230		04.06	02.09					
	E 240		03.02	02.09					
	E 270 CDI		03.02	02.09					
	E 280		05.05	02.09					
	E 280 CDI		05.04	02.09	+ USA				
	E 320		03.02	02.09	+ USA				
	E 320 CDI		11.02	02.09	+ USA				
	E 320	A400547	03.02	02.09	- USA		BAR28142		312 28,0 25,4 V L
	E 320 CDI	A400547	11.02	02.09	- USA				
	E 350	A870950	12.04	02.09					
	E 400 CDI		03.03	02.09	+ USA				
	E 280 CDI		05.04	02.09	- USA		BAR28176		295 28,0 25,4 V L
	E 300 Bluetec		09.07	02.09					
	E 320	A400548	02.09	02.09	- USA				
	E 320 CDI	A400548	02.09	02.09	- USA				
	E 350	A870951	02.09	02.09					
	E 350 CGI		09.07	02.09					
	E 200 CDI		05.02	02.09		BA2218 BAV1046	1	23334 16,1 +/WE Warnkontakt L=95mm	<b>ATE</b>
	E 200 Kompressor		05.02	02.09					
	E 220 CDI		03.02	02.09					
	E 230		04.06	02.09					
	E 240		03.02	02.09					
	E 240 4-Matic		03.03	02.09					
	E 270 CDI		03.02	02.09					
	E 280		05.05	02.09					
	E 280 4-Matic		05.05	02.09					
	E 280 CDI		05.04	02.09					
	E 280 CDI 4-Matic		05.05	02.09					
	E 300 Bluetec		09.07	02.09					
	E 320		03.02	02.09					
	E 320 4-Matic		03.03	02.09					
	E 320 CDI		11.02	02.09					
	E 320 CDI 4-Matic		05.05	02.09					
	E 350		12.04	02.09					
	E 350 4-Matic		12.04	02.09					
	E 350 CGI		09.07	02.09					
	E 400 CDI		03.03	02.09					
	E 420 CDI		01.06	02.09					
	E 500		03.02	02.09					
	E 500 4-Matic		10.03	02.09					
	E 55 Kompressor AMG		10.02	02.09		BAV1046	1	Warnkontakt L=95mm	
	E 200 CDI		05.02	02.09	- Taxi	BAR10278			300 10,0 8,3
	E 200 Kompressor		05.02	02.09					
	E 220 CDI		03.02	02.09	- Taxi				
	E 240		03.02	02.09	- Taxi				
	E 240 4-Matic		03.03	02.09					
	E 270 CDI		03.02	02.09	- Taxi				
	E 320		03.02	02.09	- Taxi				
	E 320 CDI		11.02	02.09	- Taxi				
	E 230		04.06	02.09		BAR10278		- Sportpaket 1)	300 10,0 8,3
	E 280		05.05	02.09					
	E 280 4-Matic		05.05	02.09					
	E 280 CDI		05.04	02.09					
	E 280 CDI 4-Matic		05.05	02.09					
	E 300 Bluetec		09.07	02.09					
	E 320 4-Matic		03.03	02.09					
	E 320 CDI 4-Matic		05.05	02.09					
	E 350		12.04	02.09					
	E 350 4-Matic		12.04	02.09					
	E 350 CGI		09.07	02.09					

1) - sports package / - pacchetto sportivo / - version Sport / - kit deportivo

								
<b>MERCEDES BENZ E-Klasse (W211) Limousine (02-09)</b>								
	E 400 CDI E 420 CDI E 500 E 500 4-Matic		03.03 01.06 03.02 10.03	02.09 02.09 02.09 02.09	BAR10278		- Sportpaket <sup>1)</sup>	300 10,0 8,3
<b>MERCEDES BENZ E-Klasse (S211) Kombi (03-09)</b>								
	E 200 CDI E 200 Kompressor E 220 CDI E 230 E 240 E 270 CDI E 280 CDI E 320		04.06 03.03 03.03 05.07 03.03 03.03 05.04 03.03	10.09 10.09 10.09 10.09 10.09 10.09 10.09 10.09	BA2221 BAV1023 BAV1046	1 1		23743 20,1 +/WE/S BOS Warnkontakt L=101mm Warnkontakt L=95mm
	E 320 CDI		03.03	10.09	BAV1023 BAV1046 BA2221	1 1		Warnkontakt L=101mm Warnkontakt L=95mm 23743 20,1 +/WE/S BOS
	E 280 CDI E 320 E 350 E 350 4-Matic E 350 CGI		05.04 03.03 12.04 12.04 05.06	10.09 10.09 10.09 10.09 10.09	BA2184 BA2204 BAV1023 BAV1046	1 1		23271 17,7 /WE BRE 23745 17,7 +/WE BRE Warnkontakt L=101mm Warnkontakt L=95mm
	E 280 E 320 CDI		05.05 03.03	10.09 10.09	BA2184 BA2204 BAV1023 BAV1046	1 1		23271 17,7 /WE BRE 23745 17,7 +/WE BRE Warnkontakt L=101mm Warnkontakt L=95mm
	E 500 E 500 4-Matic		10.03 10.03	10.09 10.09	BA2204 BA2184 BAV1023 BAV1046	1 1		23745 17,7 +/WE BRE 23271 17,7 /WE BRE Warnkontakt L=101mm Warnkontakt L=95mm
	E 240 4-Matic E 280 4-Matic E 280 CDI 4-Matic E 320 4-Matic E 320 CDI 4-Matic		07.03 05.05 05.05 07.03 05.05	10.09 10.09 10.09 10.09 10.09	BAV1023 BAV1046	1 1		Warnkontakt L=101mm Warnkontakt L=95mm
	E 55 Kompressor AMG		07.03	10.09	BAV1046	2		Warnkontakt L=95mm
	E 200 CDI E 200 Kompressor E 220 CDI E 230 E 240 E 270 CDI E 280 E 280 CDI E 320 E 320 CDI		04.06 03.03 03.03 05.07 03.03 03.03 05.05 05.04 03.03 03.03	10.09 10.09 10.09 10.09 10.09 10.09 10.09 10.09 10.09 10.09	BAR28141 BAR28176		- Taxi + Taxi	295 28,0 25,4 V L 295 28,0 25,4 V L
	E 280 CDI E 320 E 320 CDI E 350 E 350 CGI E 500		05.04 03.03 03.03 12.04 05.06 10.03	10.09 10.09 10.09 10.09 10.09 10.09	BAR28142			312 28,0 25,4 V L
	E 200 CDI E 200 Kompressor E 220 CDI E 230 E 240 E 240 4-Matic E 270 CDI E 280 E 280 4-Matic E 280 CDI E 280 CDI 4-Matic E 320 E 320 4-Matic E 320 CDI E 320 CDI 4-Matic E 350 E 350 4-Matic E 350 CGI E 500 E 500 4-Matic		04.06 03.03 03.03 05.07 03.03 07.03 03.03 05.05 05.05 05.04 05.05 03.03 07.03 03.03 05.05 12.04 12.04 05.06 10.03 10.03	10.09 10.09 10.09 10.09 10.09 10.09 10.09 10.09 10.09 10.09 10.09 10.09 10.09 10.09 10.09 10.09 10.09 10.09 10.09 10.09	BA2218 BAV1046	1		23334 16,1 +/WE ATE Warnkontakt L=95mm
	E 55 Kompressor AMG		07.03	10.09	BAV1046	1		Warnkontakt L=95mm
	E 200 CDI E 200 Kompressor E 220 CDI E 240 E 240 4-Matic E 350 CGI		04.06 03.03 03.03 03.03 07.03 05.06	10.09 10.09 10.09 10.09 10.09 10.09	BAR10278		- Taxi - Taxi - Taxi - Taxi	300 10,0 8,3
	E 500		10.03	10.09				
<b>MERCEDES BENZ E-Klasse (W212) Limousine (09-)</b>								
	E 200 CDI E 200 NGT E 220 CDI E 250 E 250 CDI		03.09 03.09 03.09 03.09 03.09		BAV1046	1		Warnkontakt L=95mm

<sup>1)</sup> - sports package / - pacchetto sportivo / - version Sport / - kit deportivo

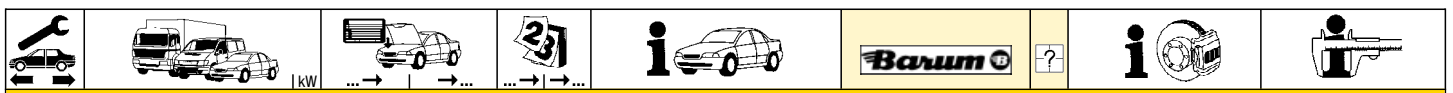



















**MERCEDES BENZ E-Klasse (W212) Limousine (09-)**

	E 200 CGI	08.09	BAV1046	1	Warnkontakt L=95mm
	E 250 CDI 4matic	03.09			
	E 250 CGI	01.09			
	E 300	03.09			
	E 300 BE 4matic	07.11			
	E 300 BlueEfficiency	07.11			
	E 300 BlueTec Hybrid	06.12			
	E 300 CDI	04.11			
	E 350	03.09			
	E 350	09.11			
	E 350 4-Matic	03.09			
	E 350 Bluetec	03.09			
	E 350 CDI	03.09			
	E 350 CDI 4-Matic	03.09			
	E 350 CGI	03.09			
E 400 Hybrid	06.12	BAV1046	1	Warnkontakt L=95mm	
E 350 4-Matic	09.11	BAV1046	1	Warnkontakt L=95mm	
E 500	03.09	BAV1046	1	Warnkontakt L=95mm	
E 500 4-Matic	03.09				
E 500	09.11	BAV1046	1	Warnkontakt L=95mm	
E 500 4-Matic	09.11				
	E 200 CDI	03.09	BAV1046	1	Warnkontakt L=95mm
	E 200 CGI	08.09			
	E 200 NGT	03.09			
	E 220 CDI	03.09			
	E 250	03.09			
	E 250 CDI	03.09			
	E 250 CDI 4matic	03.09			
	E 250 CGI	01.09			
	E 300	03.09			
	E 300 BlueEfficiency	07.11			
	E 300 BlueTec Hybrid	06.12			
	E 300 CDI	04.11			
	E 350	03.09			
	E 350	09.11			
	E 350 4-Matic	03.09			
	E 350 4-Matic	09.11			
	E 350 Bluetec	03.09			
	E 350 CDI	03.09			
	E 350 CDI 4-Matic	03.09			
	E 350 CGI	03.09			
E 400 Hybrid	06.12				
E 500	03.09				
E 500	09.11				
E 500 4-Matic	03.09				
E 500 4-Matic	09.11				
	E 200 CDI	03.09	BAR10278		300 10,0 8,3
	E 200 NGT	03.09			
	E 220 CDI	03.09			
	E 250	03.09			
	E 250 CGI	01.09			

























**MERCEDES BENZ E-Klasse (S212) Kombi (09-)**

	E 200 CDI	11.09	BAV1046	1	Warnkontakt L=95mm			
	E 200 CGI	11.09						
	E 220 CDI	11.09						
	E 250 CDI	11.09						
	E 250 CDI 4matic	07.10						
	E 250 CGI	11.09						
	E 300 4matic	07.11						
	E 300 BlueTec Hybrid	06.12						
	E 350	11.09						
	E 350	09.11						
	E 350 4-matic	11.09						
	E 350 BlueTec	11.09						
	E 350 CDI	11.09						
	E 350 CDI 4-matic	11.09						
	E 350 CGI	11.09						
E 300	07.11	BAV1046	1	Warnkontakt L=95mm				
E 350 4-matic	09.11	BAV1046	1	Warnkontakt L=95mm				
E 500	11.09	BAV1046	2	Warnkontakt L=95mm				
E 500	09.11	BAV1046	1	Warnkontakt L=95mm				
E 500 4-Matic	09.11							
	E 200 CDI	11.09	BAV1046	1	Warnkontakt L=95mm			
	E 200 CGI	11.09						
	E 220 CDI	11.09						
	E 250 CDI	11.09						
	E 250 CDI 4matic	07.10						
	E 300	07.11						
	E 300 4matic	07.11						
	E 300 BlueTec Hybrid	06.12						
	E 350	11.09						
	E 350	09.11						
	E 350 4-matic	11.09						
	E 350 4-matic	09.11						









								
<b>MERCEDES BENZ E-Klasse (S212) Kombi (09-)</b>								
	E 350 BlueTec E 350 CDI E 350 CDI 4-matic E 350 CGI E 350 CGI E 500 E 500 E 500 4-Matic		11.09 11.09 11.09 11.09 11.09 09.11 09.11		BAV1046	1		Warnkontakt L=95mm
	E 200 CDI E 200 CGI E 220 CDI E 250 CDI E 250 CDI 4matic E 250 CGI		11.09 11.09 11.09 11.09 07.10 11.09		BAR10278			300 10,0 8,3
<b>MERCEDES BENZ E-Klasse (C207) Coupe (09-)</b>								
	E 250 CDI E 350 E 350 CDI E 350 CGI E 300 CGI E 200 CGI E 220 CDI E 250 CGI E 500		05.09 09.09 05.09 05.09 04.11 09.09 05.09 05.09 05.09		BAV1046 BAV1046 BAV1046 BAV1046 BAV1046	1 1 1 1 1		Warnkontakt L=95mm Warnkontakt L=95mm Warnkontakt L=95mm Warnkontakt L=95mm
	E 200 CGI E 220 CDI E 250 CDI E 250 CGI E 300 CGI E 350 E 350 CDI E 350 CGI E 500		09.09 05.09 05.09 05.09 04.11 09.09 05.09 05.09 05.09		BAH0018	2		L=385
	E 300 CGI E 350 E 350 CDI E 350 CGI E 500 E 200 CGI E 220 CDI E 250 CDI E 250 CGI		04.11 09.09 05.09 05.09 05.09 09.09 05.09 05.09 05.09		BAV1046 BAV1046	1 1		Warnkontakt L=95mm Warnkontakt L=95mm
<b>MERCEDES BENZ E-Klasse (A207) Cabrio (10-)</b>								
	E 200 CGI E 220 CDI E 250 CGI E 250 CDI E 300 CGI E 350 E 350 CDI E 350 CGI E 500		03.10 03.10 03.10 03.10 03.10 03.10 03.10 03.10 03.10		BAV1046 BAV1046 BAV1046	1 1 1		Warnkontakt L=95mm Warnkontakt L=95mm Warnkontakt L=95mm
	E 200 CGI E 220 CDI E 250 CDI E 250 CGI E 300 CGI E 350 E 350 CDI E 350 CGI E 500		03.10 03.10 03.10 03.10 03.10 03.10 03.10 03.10 03.10		BAH0018	2		L=385
	E 200 CGI E 220 CDI E 250 CGI E 250 CDI E 300 CGI E 350 E 350 CDI E 350 CGI E 500		03.10 03.10 03.10 03.10 03.10 03.10 03.10 03.10 03.10		BAV1046 BAV1046 BAV1046	1 1 1		Warnkontakt L=95mm Warnkontakt L=95mm Warnkontakt L=95mm
<b>MERCEDES BENZ G-Klasse (W463) (90-)</b>								
	230 GE 250 GD 300 GD 300 GE 350 G Turbo G 270 CDI G 300 TD G 320 G 36 AMG G 400 CDI G 500		06.90 06.90 09.89 06.90 09.91 10.01 08.96 09.94 01.95 12.00 04.98		BA2101 BAV1032	2	- belüftete Scheiben <sup>1)</sup> - belüftete Scheiben <sup>1)</sup>	20784 18,0 /WE Warnkontakt L=260mm
								ATE

<sup>1)</sup> - ventilated discs / - dischi ventilati / - disques ventilés / - disco ventilado

















													
<b>MERCEDES BENZ G-Klasse (W463) (90-)</b>													
	G 500 E		09.93		BA2101		- belüftete Scheiben <sup>1)</sup> - belüftete Scheiben <sup>1)</sup>	20784 18,0 /WE Warnkontakt L=260mm	ATE				
	G 55 AMG		04.99		BAV1032	2							
	G 320 CDI		09.06		BAV1032	2		Warnkontakt L=260mm					
	G 350 CDI BlueTec		06.10										
	G 320 CDI		09.06		BA2216	2		23021 18,9 /WE Warnkontakt L=185mm	BOS				
	G 350 CDI BlueTec		06.10		BAV1008								
	G 320 CDI		09.06		BAR16110			272 16,0 14,0 L					
	G 350 CDI BlueTec		06.10										
<b>MERCEDES BENZ G-Klasse (W463) Cabrio (90-)</b>													
	230 GE		06.90		BA2101	2	- belüftete Scheiben <sup>1)</sup> - belüftete Scheiben <sup>1)</sup>	20784 18,0 /WE Warnkontakt L=260mm	ATE				
	300 GD		12.90		BAV1032								
	300 GE		09.89										
	320 GE		09.94										
	350 G Turbo		09.91										
	G 300 TD		09.96										
	G 320		11.97										
	G 400 CDI		12.00										
	G 500		04.98										
	G 320 CDI		06.10		BAV1032								
G 350 CDI BlueTec		06.10											
	G 320 CDI		09.06		BA2216	2		23021 18,9 /WE Warnkontakt L=185mm	BOS				
	G 350 CDI BlueTec		06.10		BAV1008								
	G 320 CDI		09.06		BAR16110			272 16,0 14,0 L					
	G 350 CDI BlueTec		06.10										
<b>MERCEDES BENZ GLK-Klasse (X204) (08-)</b>													
	GLK 200 CDI		07.10		BAV1046	1		Warnkontakt L=95mm					
	GLK 220 BT 4matic		03.12										
	GLK 220 CDI		04.09										
	GLK 220 CDI 4matic		04.09										
	GLK 250 BT 4matic		03.12										
	GLK 250 CDI 4matic		09.08										
	GLK 280 4matic		09.08										
	GLK 300 4matic		04.09										
	GLK 320 CDI 4matic		09.08										
	GLK 350		09.08										
	GLK 350 4matic		09.08										
	GLK 350 CDI 4matic		04.09										
		GLK 200 CDI		07.10			BAV1046			1		Warnkontakt L=95mm	
		GLK 220 BT 4matic		03.12									
GLK 220 CDI			04.09										
GLK 220 CDI 4matic			04.09										
GLK 250 BT 4matic			03.12										
GLK 250 CDI 4matic			09.08										
GLK 280 4matic			09.08										
GLK 300 4matic			04.09										
GLK 320 CDI 4matic			09.08										
GLK 350			09.08										
GLK 350 4matic			09.08										
GLK 350 CDI 4matic			04.09										
<b>MERCEDES BENZ M-Klasse (W163) (98-05)</b>													
		ML 230		03.98	06.05	BA2191			23193 17,3 +/-WK				
	ML 270 CDI		09.99										
	ML 270 CDI	X754619	09.99										
	ML 320	A289559	09.99										
	ML 320	X754619	03.98										
	ML 430	A289559	03.98										
	ML 430	X707755	09.98										
	ML 270 CDI	A289560	06.05		BA2184	2		23271 17,7 /WE Warnkontakt L=114mm	BRE				
	ML 270 CDI	X754620	06.05		BAV1024								
	ML 320	A289560	08.02										
	ML 320	X754620	08.02										
	ML 350		09.02	06.05									
	ML 400 CDI		07.01	06.05	BA2184	2		23271 17,7 /WE Warnkontakt L=114mm	BRE				
	ML 430	A145273	06.05		BAV1024								
	ML 430	X707756	06.05										
	ML 500		07.01	06.05	BA2184	2		23271 17,7 /WE Warnkontakt L=114mm	BRE				
	ML 55 AMG		09.99	06.05	BAV1024								
	ML 230		03.98	06.05	BAR26116			303 26,0 23,0 V L					
	ML 270 CDI		09.99										
	ML 270 CDI	X754619	09.99										
	ML 320	A289559	09.99										
	ML 320	X754619	03.98										
	ML 430	A289559	03.98										
ML 430	X707755	09.98											
	ML 430	A145272	09.98										

<sup>1)</sup> - ventilated discs / - dischi ventilati / - disques ventilés / - disco ventilado





















MERCEDES BENZ M-Klasse (W163) (98-05)									
	ML 230			03.98	11.98	BA2192			23189 16,7 +WK
	ML 320			03.98	11.98				
	ML 430			09.98	11.98				
	ML 270 CDI	A289560			06.05	BAV1047	2		Warnkontakt L=70(147)mm
	ML 270 CDI	X754620			06.05				
	ML 320	A289560			08.02				
	ML 320	X754620			08.02				
	ML 350			09.02	06.05				
	ML 400 CDI			07.01	06.05				
	ML 430	A145273			06.05				
ML 430	X707756			06.05					
ML 500			07.01	06.05					
ML 55 AMG			09.99	06.05					
MERCEDES BENZ M-Klasse (W166) (11-)									
	ML 250 CDI BT 4matic			06.11		BAV1046	1		Warnkontakt L=95mm
	ML 350 BE 4matic			06.11					
	ML 350 BT 4matic			06.11					
	ML 350 CDI 4matic			06.11					
	ML 400 Hybrid 4matic			02.12					
	ML 500 BE 4matic			02.12		BAV1046	1		Warnkontakt L=95mm
ML 63 AMG 4matic			04.12		BAV1046	1		Warnkontakt L=95mm	
MERCEDES BENZ S-Klasse (W140) (91-93)									
	300 SE 3.2		A050547	04.91	+ Leichtmetallfelgen 1)	BAV1004	4		Warnkontakt L=94mm
	300 SE 3.2		A023718	04.91	- Leichtmetallfelgen 2)				
	300 SEL 3.2		A050547	04.91	+ Leichtmetallfelgen 1)				
	300 SEL 3.2		A023718	04.91	- Leichtmetallfelgen 2)				
	300 SE 2.8			08.92	06.93	BA2174	4		21303 18,8 /WE ATE
	300 SE 3.2	A023719			06.93	BAV1004			Warnkontakt L=94mm
	300 SE 3.2	A050548			06.93				
	300 SEL 3.2	A023719			06.93				
	300 SEL 3.2	A050548			06.93				
	350 SD Turbo			03.93	06.93				
400 SE			04.91	06.93					
400 SEL			04.91	06.93					
500 SE			04.91	06.93					
500 SEC			06.92	06.93					
500 SEL			04.91	06.93					
600 SE V12			04.91	06.93					
600 SEC V12			06.92	06.93					
600 SEL V12			04.91	06.93					
	300 SE 2.8			08.92	06.93	BA2163	4		21305 15,5 /WE ATE
	300 SE 3.2			04.91	06.93	BAV1004			Warnkontakt L=94mm
	300 SEL 3.2			04.91	06.93				
	350 SD Turbo			03.93	06.93				
	400 SE			04.91	06.93				
	400 SEL			04.91	06.93				
	500 SE			04.91	06.93				
	500 SEC			06.92	06.93				
	500 SEL			04.91	06.93				
	600 SE V12			04.91	06.93				
600 SEC V12			06.92	06.93					
600 SEL V12			04.91	06.93					
	300 SE 2.8			08.92	06.93	BAH0004	2		L=280
	300 SE 3.2			04.91	06.93				
	300 SEL 3.2			04.91	06.93				
	350 SD Turbo			03.93	06.93				
	400 SE			04.91	06.93				
	400 SEL			04.91	06.93				
	500 SE			04.91	06.93				
	500 SEC			06.92	06.93				
	500 SEL			04.91	06.93				
	600 SE V12			04.91	06.93				
600 SEC V12			06.92	06.93					
600 SEL V12			04.91	06.93					
MERCEDES BENZ S-Klasse (W140) (93-98)									
	S 280			07.93	10.98	BA2174	4		21303 18,8 /WE ATE
	S 300 TD			04.96	10.98	BAV1004			Warnkontakt L=94mm
	S 320			07.93	10.98				
	S 350 TD			07.93	06.96				
	S 420			07.93	10.98				
	S 420 C			04.94	05.96				
	S 500			07.93	10.98				
	S 500 C			07.93	05.96				
	S 600			07.93	10.98				
	S 600 C			07.93	05.96				
	S 280	A290167			10.98	BAH0028	2		L=480
	S 300 TD			04.96	10.98				
	S 320	A290167			10.98				
	S 350 TD	A290167			06.96				
	S 420	A290167			10.98				
	S 420 C			09.95	05.96				
	S 500	A290167			10.98				
S 500 C			09.95	05.96					

























1) + light alloy rims / + cerchioni in lega / + jantes en alliage léger / + Llantas de aleación ligera



















2) - light alloy rims / - cerchioni in lega / - jantes en alliage léger / - Llantas de aleación ligera

MERCEDES BENZ S-Klasse (W140) (93-98)										
	S 600 S 600 C	A290167		09.95	10.98	05.96	BAH0028	2		L=480
	S 280 S 300 TD S 320 S 350 TD S 420 S 420 C S 500 S 500 C S 600 S 600 C			07.93 04.96 07.93 07.93 07.93 04.94 07.93 07.93 07.93 07.93	10.98 10.98 10.98 06.96 10.98 05.96 10.98 05.96 10.98 05.96		BA2163 BAV1004	4		21305 15,5 /WE Warnkontakt L=94mm
	S 280 S 300 TD S 320 S 350 TD S 420 S 420 C S 500 S 500 C S 600 S 600 C			07.93 04.96 07.93 07.93 07.93 04.94 07.93 07.93 07.93 07.93	10.98 10.98 10.98 06.96 10.98 05.96 10.98 05.96 10.98 05.96		BAH0004	2		L=280
MERCEDES BENZ S-Klasse (W220) (98-06)										
	S 280 S 320 S 320 CDI			11.98 11.98 08.99	12.01 12.01 12.01		BA2184 BAV1046	2		23271 17,7 /WE Warnkontakt L=95mm
	S 400 CDI S 430			08.00 11.98	12.01 12.01		BA2184 BAV1046	2		23271 17,7 /WE Warnkontakt L=95mm
	S 500 S 55 AMG			11.98 04.99	12.01 12.01	- gepanzerte Fahrzeuge <sup>1)</sup>	BA2184 BAV1046	2		23271 17,7 /WE Warnkontakt L=95mm
	S 280 S 320 S 320 CDI S 350 S 370			01.02 01.02 01.02 09.02 08.04	03.06 03.06 03.06 03.06 03.06		BA2184 BA2204 BAV1023 BAV1046	1 1	 	23271 17,7 /WE 23745 17,7 +/WE Warnkontakt L=101mm Warnkontakt L=95mm
	S 400 CDI S 430			01.02 01.02	03.06 03.06		BA2204 BA2184 BAV1023 BAV1046	1 1	 	23745 17,7 +/WE 23271 17,7 /WE Warnkontakt L=101mm Warnkontakt L=95mm
	S 500 S 55 AMG S 600			01.02 01.02 08.99	03.06 03.06 03.06	- gepanzerte Fahrzeuge <sup>1)</sup> - gepanzerte Fahrzeuge <sup>1)</sup>	BA2204 BA2184 BAV1023 BAV1046	1 1	 	23745 17,7 +/WE 23271 17,7 /WE Warnkontakt L=101mm Warnkontakt L=95mm
	S 350 4-Matic			06.03	03.06		BAV1023 BAV1046	1 1	 	Warnkontakt L=101mm Warnkontakt L=95mm
	S 55 Kompressor AMG S 65 AMG			06.02 03.04	03.06 03.06		BAV1046	2		Warnkontakt L=95mm
	S 500 S 600			11.98 08.99	03.06 03.06	+ gepanzerte Fahrzeuge <sup>2)</sup> + gepanzerte Fahrzeuge <sup>2)</sup>	BAV1046	2		Warnkontakt L=95mm
	S 320 CDI S 400 CDI S 430 S 500			08.99 08.00 11.98 11.98	03.06 03.06 03.06 03.06	- gepanzerte Fahrzeuge <sup>1)</sup>	BAR32115			330 32,0 30,0 V L
	S 280 S 320 S 320 CDI S 350 S 370 S 400 CDI S 430 S 500 S 55 AMG			11.98 11.98 08.99 09.02 08.04 08.00 11.98 11.98 04.99	03.06 03.06 03.06 03.06 03.06 09.02 09.02 09.02 09.02	- gepanzerte Fahrzeuge <sup>1)</sup>	BAV1046	1		Warnkontakt L=95mm
	S 350 4-Matic S 400 CDI S 430 S 430 4-Matic S 500 S 500 4-Matic S 600			06.03 10.02 10.02 09.02 10.02 09.02 08.99	03.06 03.06 03.06 03.06 03.06 03.06 03.06	- gepanzerte Fahrzeuge <sup>1)</sup> - gepanzerte Fahrzeuge <sup>1)</sup>	BA2218 BAV1046	1		23334 16,1 +/WE Warnkontakt L=95mm
	S 55 Kompressor AMG			06.02	03.06		BAV1046	1		Warnkontakt L=95mm
	S 500 S 600			11.98 08.99	03.06 03.06	+ gepanzerte Fahrzeuge <sup>2)</sup> + gepanzerte Fahrzeuge <sup>2)</sup>	BA2163 BAV1046	1		21305 15,5 /WE Warnkontakt L=95mm
	S 65 AMG			03.04	03.06		BAV1046	1		Warnkontakt L=95mm
MERCEDES BENZ S-Klasse (W221) (06-)										
	S 600	A000100	12.05				BAV1046	1		Warnkontakt L=95mm
	S 250 CDI		01.11				BAV1046	1		Warnkontakt L=95mm

<sup>1)</sup> - armoured vehicles / - veicoli blindati / - véhicule blindé / - vehiculo blindado  
<sup>2)</sup> + armoured vehicles / + veicoli blindati / + véhicule blindé / + vehiculo blindado

									
<b>MERCEDES BENZ S-Klasse (W221) (06-)</b>									
	S 280 S 320 CDI S 320 CDI 4-Matic S 350 S 350 4-Matic S 350 CDI 4-matic BE S 420 CDI S 450 S 450 4-Matic S 500 S 500 4-Matic S 600 S 400 Hybrid		04.06 12.05 05.06 12.05 02.07 04.09 04.06 04.06 12.05 04.06 12.05 04.06 12.05 06.09		BA2218 BAV1046          BAV1046 BA2218 BAV1046	1             1  1			23334 16,1 +/WE ATE Warnkontakt L=95mm             Warnkontakt L=95mm 23334 16,1 +/WE ATE Warnkontakt L=95mm
<b>MERCEDES BENZ SL-Klasse (R129) (93-01)</b>									
	SL 280 SL 320	F 187941 F 187941	08.93 08.93		BAV1004 BA2182 BA2184	2	- ESP + ESP	Warnkontakt L=94mm 21153 17,5 /WE ATE 23271 17,7 /WE BRE	
	SL 280 SL 320	F 187942 F 187942		09.01 09.01	BA2184 BAV1004	4	+ ESP	23271 17,7 /WE BRE Warnkontakt L=94mm	
	SL 500 SL 60 AMG SL 600		08.93 05.94 08.93	09.01 09.01 09.01	BA2182 BA2184 BAV1004	2	- ESP + ESP	21153 17,5 /WE ATE 23271 17,7 /WE BRE Warnkontakt L=94mm	
	SL 280 SL 320 SL 500 SL 60 AMG SL 600	F125157 F125157 F125157 F125157 F125157	08.93 08.93 08.93 05.94 08.93		BAH0009	2		L=340	
	SL 280 SL 320 SL 500 SL 60 AMG	F 187941 F 187941 F 125157 F 125157	08.93 08.93 08.93 05.94		BA2161 BAV1004	4		21197 15,0 /WE ATE Warnkontakt L=94mm	
	SL 280 SL 320 SL 500 SL 60 AMG SL 600	F 187942 F 187942 F 125158 F 125158		09.01 09.01 09.01 09.01 08.93 09.01	BA2163 BAV1004	1		21305 15,5 /WE ATE Warnkontakt L=94mm	
	SL 280 SL 320 SL 500 SL 60 AMG SL 600		08.93 08.93 08.93 05.94 08.93	09.01 09.01 09.01 09.01 09.01	BAH0004	2		L=280	
<b>MERCEDES BENZ SL-Klasse (R230) (01-11)</b>									
	SL 280 SL 350		11.07 02.03	11.11 11.11	BAV1046 BA2184 BA2204 BAV1023 BAV1046	1 1 1		Warnkontakt L=95mm 23271 17,7 /WE BRE 23745 17,7 +/WE BRE Warnkontakt L=101mm Warnkontakt L=95mm	
	SL 500		09.01	11.11	BA2204 BA2184 BAV1023 BAV1046	1 1 1		23745 17,7 +/WE BRE 23271 17,7 /WE BRE Warnkontakt L=101mm Warnkontakt L=95mm	
	SL 55 AMG SL 600 SL 65 AMG		09.01 04.03 03.04	11.11 11.11 11.11	BAV1046	2		Warnkontakt L=95mm	
	SL 280 SL 350 SL 500 SL 55 AMG SL 600 SL 65 AMG		11.07 02.03 09.01 09.01 04.03 03.04	11.11 11.11 11.11 11.11 11.11 11.11	BA2218 BAV1046  BAV1046 BAV1046	1 1 1 1		23334 16,1 +/WE ATE Warnkontakt L=95mm Warnkontakt L=95mm Warnkontakt L=95mm Warnkontakt L=95mm	
<b>MERCEDES BENZ SL-Klasse (R231) (12-)</b>									
	SL 350 SL 500 SL 63 AMG SL 65 AMG	225 300 386	03.12 03.12 03.12 03.12		BAV1046 BAV1046	1 1		Warnkontakt L=95mm Warnkontakt L=95mm	
<b>MERCEDES BENZ SLK-Klasse (R170) (96-04)</b>									
	SLK 200 SLK 200 Kompressor SLK 230 Kompressor SLK 320		09.96 09.96 09.96 04.00	03.04 03.04 03.04 03.04	BA2150 BAV1004  BA2168 BAV1004	2 2		21664 19,1 +/WE ATE Warnkontakt L=94mm 21670 20,3 +/WE ATE Warnkontakt L=94mm	
	SLK 200 SLK 200 Kompressor SLK 230 Kompressor SLK 320		09.96 09.96 09.96 04.00	03.04 03.04 03.04 03.04	BAR25110 BAR28106	2		288 25,0 22,4 V L 300 28,0 25,4 V L	
	SLK 200 SLK 200 Kompressor SLK 230 Kompressor SLK 32 AMG		09.96 09.96 09.96 03.01	03.04 03.04 03.04 03.04	BAH0018	2		L=385	

								
<b>MERCEDES BENZ SLK-Klasse (R170) (96-04)</b>								
	SLK 320		04.00	03.04	BAH0018	2		L=385
	SLK 200 SLK 200 Kompressor SLK 230 Kompressor	F017687 F017687 F017687	09.96 09.96 09.96		BA2161 BAV1004	2		21197 15,0 /WE Warnkontakt L=94mm
	SLK 200 SLK 200 Kompressor SLK 230 Kompressor SLK 320	F017688 F017688 F017688		03.04 03.04 03.04 04.00	BA2164			21919 15,8
	SLK 32 AMG		03.01	03.04	BA2163			21305 15,5 /WE
	SLK 200 SLK 200 Kompressor SLK 230 Kompressor SLK 320		09.96 09.96 09.96 04.00	03.04 03.04 03.04 03.04	BAR09114			278 9,0 7,3
	SLK 200 SLK 200 Kompressor SLK 230 Kompressor SLK 32 AMG SLK 320		09.96 09.96 09.96 03.01 04.00	03.04 03.04 03.04 03.04 03.04	BAH0006	2		L=280
<b>MERCEDES BENZ SLK-Klasse (R171) (04-11)</b>								
	SLK 200 Kompressor		03.04	01.11	BA2177 BAV1046	1		23144 19,8 +/WE/S Warnkontakt L=95mm
	SLK 280 SLK 300		04.05 03.09	01.11 01.11	BA2177 BAV1046	2		23144 19,8 +/WE/S Warnkontakt L=95mm
	SLK 350		03.04	01.11	BA2204 BA2184 BAV1046	1		23745 17,7 +/WE 23271 17,7 /WE Warnkontakt L=95mm
	SLK 200 Kompressor		03.04	01.11	BAR25110			288 25,0 22,4 V L
	SLK 280 SLK 300		04.05 03.09	01.11 01.11	BAR28106			300 28,0 25,4 V L
	SLK 200 Kompressor SLK 280 SLK 300 SLK 350 SLK 55 AMG		03.04 04.05 03.09 03.04 03.04	01.11 01.11 01.11 01.11 01.11	BAH0018	2		L=385
	SLK 200 Kompressor SLK 280 SLK 300		03.04 04.05 03.09	01.11 01.11 01.11	BA2164			21919 15,8
	SLK 350		03.04	01.11	BA2206 BAV1046	1		21899 15,1 /WE Warnkontakt L=95mm
	SLK 55 AMG		03.04	01.11	BAV1046	1		Warnkontakt L=95mm
	SLK 200 Kompressor SLK 280 SLK 300 SLK 350		03.04 04.05 03.09 03.04	01.11 01.11 01.11 01.11	BAR09114			278 9,0 7,3
	SLK 350		03.04	01.11	BAR10217			290 10,0 8,3
	SLK 200 Kompressor SLK 280 SLK 300 SLK 350 SLK 55 AMG		03.04 04.05 03.09 03.04 03.04	01.11 01.11 01.11 01.11 01.11	BAH0006	2		L=280
<b>MERCEDES BENZ SLK-Klasse (R172) (11-)</b>								
	SLK 200 SLK 250		02.11 02.11		BAV1046	1		Warnkontakt L=95mm
	SLK 250 CDI SLK 350		01.12 02.11		BAV1046	1		Warnkontakt L=95mm
	SLK 55 AMG		01.12		BAV1046	1		Warnkontakt L=95mm
	SLK 200 SLK 250 SLK 250 CDI SLK 350 SLK 55 AMG		02.11 02.11 01.12 02.11 01.12		BAH0018	2		L=385
	SLK 200 SLK 250 SLK 250 CDI SLK 350		02.11 02.11 01.12 02.11		BAV1046	1		Warnkontakt L=95mm
	SLK 55 AMG		01.12		BAV1046	1		Warnkontakt L=95mm
<b>MERCEDES BENZ SLR-Klasse (C199) Coupe (04-09)</b>								
	SLR 5.4 McLaren	460	12.03	12.09	BAV1046	2		Warnkontakt L=95mm
<b>MERCEDES BENZ Vaneo (BM414) (02-05)</b>								
	1.4 1.6 1.6 1.7 CDI 1.7 CDI 1.9	60 60 75 55 67 92	06.02 02.02 02.02 02.02 02.02 02.02	12.05 12.05 12.05 12.05 12.05 12.05	BAV1046	1		Warnkontakt L=95mm

									
<b>MERCEDES BENZ Vaneo (BM414) (02-05)</b>									
	1.4 1.6 1.6 1.7 CDI 1.7 CDI 1.9	60 60 75 55 67 92		06.02 02.02 02.02 02.02 02.02 02.02	12.05 12.05 12.05 12.05 12.05 12.05	BA2220		23138 14,6 /S	LUC
	1.4 1.6 1.6 1.7 CDI 1.7 CDI 1.9	60 60 75 55 67 92		06.02 02.02 02.02 02.02 02.02 02.02	12.05 12.05 12.05 12.05 12.05 12.05	BAR08111		258 8,0 7,0	
<b>MERCEDES BENZ V-Klasse (BM638) (96-03)</b>									
	V 200 V 200 CDI V 220 CDI V 230 V 230 TD V 280			09.96 03.99 03.99 09.96 09.96 09.97	08.03 08.03 08.03 08.03 08.03 08.03	BA2149 BAV1026	2	21576 20,5 +/WE Warnkontakt L=80mm	ATE
	V 200 V 200 CDI V 220 CDI V 230 V 230 TD V 280			09.96 03.99 03.99 09.96 09.96 09.97	08.03 08.03 08.03 08.03 08.03 08.03	BA2091 BAV1008	2	23022 20,9 /WE Warnkontakt L=185mm	BOS
	V 200 V 200 CDI V 220 CDI V 230 V 230 TD V 280			09.96 03.99 03.99 09.96 09.96 09.97	08.03 08.03 08.03 08.03 08.03 08.03	BAR22162		276 22,0 19,0 V	
	V 200 V 200 CDI V 220 CDI V 230 V 230 TD V 280			09.96 03.99 03.99 09.96 09.96 09.97	08.03 08.03 08.03 08.03 08.03 08.03	BA2250 BA2290		21904 17,0 +/WK 23020 17,9	ATE BOS
	V 200 V 200 CDI V 220 CDI V 230 V 230 TD V 280			09.96 03.99 03.99 09.96 09.96 09.97	08.03 08.03 08.03 08.03 08.03 08.03	BAR10228		280 10,0 8,0 L	
<b>MERCEDES BENZ Viano (BM639) (03-)</b>									
	2.0 CDI 2.0 CDI 4-matic 2.2 CDI 2.2 CDI 4-matic 3.0 3.0 CDI 3.2 3.5 3.7		342257 342257 342257 342257 342257 342257 342257 342257 342257	08.03 07.10 08.03 07.10 08.03 03.06 08.03 09.07 06.04		BA2263 BAV1048	2	24007 20,9 /WE/S Warnkontakt L=95mm	BOS
	2.0 CDI 2.0 CDI 4-matic 2.2 CDI 2.2 CDI 4-matic 3.0 3.0 CDI 3.2 3.5 3.7	342258 342258 342258 342258 140 342258 342258 160 342258 190 342258 170 342258				BA2281		29192 20,9 /WE/Zub	BRE
	2.0 CDI 2.0 CDI 4-matic 2.2 CDI 2.2 CDI 4-matic 3.0 3.0 CDI 3.2 3.5 3.7			08.03 07.10 08.03 07.10 08.03 03.06 08.03 09.07 06.04		BA2264 BAV1048	2	24008 17,7 /WE/S Warnkontakt L=95mm	BOS
	2.0 CDI 2.0 CDI 4-matic 2.2 CDI 2.2 CDI 4-matic 3.0 3.0 CDI 3.2 3.5 3.7			08.03 07.10 08.03 07.10 08.03 03.06 08.03 09.07 06.04		BAR10280		296 10,0 8,0	

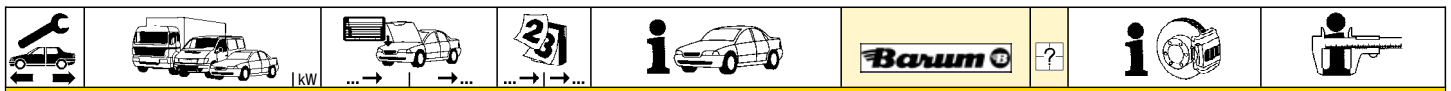

















**MERCEDES BENZ VITO (BM638) (96-03)**

	108 CDI		03.99	08.03	BA2149 BAV1026	2		21576 20,5 +/WE Warnkontakt L=80mm	ATE
	108 D		03.96	08.03					
	110 CDI		03.99	08.03					
	110 D		03.96	08.03					
	112 CDI		03.99	08.03					
	113		03.96	08.03					
114		12.96	08.03						
	108 CDI		03.99	08.03	BA2091 BAV1008	2		23022 20,9 /WE Warnkontakt L=185mm	BOS
	108 D		03.96	08.03					
	110 CDI		03.99	08.03					
	110 D		03.96	08.03					
	112 CDI		03.99	08.03					
	113		03.96	08.03					
114		12.96	08.03						
	108 CDI		03.99	08.03	BAR22162			276 22,0 19,0 V	
	108 D		03.96	08.03					
	110 CDI		03.99	08.03					
	110 D		03.96	08.03					
	112 CDI		03.99	08.03					
	113		03.96	08.03					
114		12.96	08.03						
	108 CDI		03.99	08.03	BA2250 BA2290			21904 17,0 +/WK 23020 17,9	ATE BOS
	108 D		03.96	08.03					
	110 CDI		03.99	08.03					
	110 D		03.96	08.03					
	112 CDI		03.99	08.03					
	113		03.96	08.03					
114		12.96	08.03						
	108 CDI		03.99	08.03	BAR10228			280 10,0 8,0 L	
	108 D		03.96	08.03					
	110 CDI		03.99	08.03					
	110 D		03.96	08.03					
	112 CDI		03.99	08.03					
	113		03.96	08.03					
114		12.96	08.03						

**MERCEDES BENZ VITO (BM639) (03-)**

	109 CDI	65	342257	08.03	BA2263 BAV1048	2		24007 20,9 /WE/S Warnkontakt L=95mm	BOS
	109 CDI 4-matic	70	342257	09.07					
	110 CDI		342257	09.10					
	111 CDI		342257	08.03					
	111 CDI 4-matic	80	342257	09.07					
	113 CDI		342257	09.10					
	113 CDI 4-matic		342257	09.10					
	115 CDI	110	342257	08.03					
	115 CDI 4-matic	110	342257	09.07					
	116 CDI		342257	09.10					
	116 CDI 4-matic		342257	09.10					
	119	140	342257	08.03					
	120 CDI	150	342257	09.07					
	122	160	342257	08.03					
	122 CDI		342257	09.10					
	123	170	342257	06.04					
	123	190	342257	09.07					
126	190	342257	09.07						
	109 CDI	65	342258		BA2281			29192 20,9 /WE/Zub	BRE
	109 CDI 4-matic	70	342258						
	110 CDI		342258						
	111 CDI		342258						
	111 CDI 4-matic	80	342258						
	113 CDI		342258						
	113 CDI 4-matic		342258						
	115 CDI	110	342258						
	115 CDI 4-matic	110	342258						
	116 CDI		342258						
	116 CDI 4-matic		342258						
	119	140	342258						
	120 CDI	150	342258						
	122	160	342258						
	122 CDI		342258						
	123	170	342258						
	123	190	342258						
126	190	342258							
	109 CDI	65		08.03	BA2264 BAV1048	2		24008 17,7 /WE/S Warnkontakt L=95mm	BOS
	109 CDI 4-matic	70		09.07					
	110 CDI			09.10					
	111 CDI			08.03					
	111 CDI 4-matic	80		09.07					
	113 CDI			09.10					
	113 CDI 4-matic			09.10					
	115 CDI	110		08.03					
	115 CDI 4-matic	110		09.07					
	116 CDI			09.10					
	116 CDI 4-matic			09.10					
119	140		08.03						
120 CDI	150		09.07						
122	160		08.03						

















								
<b>MERCEDES BENZ VITO (BM639) (03-)</b>								
	122 CDI 123 170 123 190 126 190		09.10 06.04 09.07 09.07		BA2264 BAV1048	2		24008 17,7 /WE/S Warnkontakt L=95mm <b>BOS</b>
	109 CDI 65 109 CDI 4-matic 70 110 CDI 111 CDI 111 CDI 4-matic 80 113 CDI 113 CDI 4-matic 115 CDI 110 115 CDI 4-matic 110 116 CDI 116 CDI 4-matic 119 140 120 CDI 150 122 160 122 CDI 123 170 123 190 126 190		08.03 09.07 09.10 08.03 09.07 09.10 09.10 08.03 09.07 09.10 09.10 08.03 09.07 09.10 09.10 08.03 09.07 09.10 09.10 08.03 09.07 09.10 06.04 09.07 09.07		BAR10280			296 10,0 8,0
<b>MERCEDES BENZ Transporter (BM 631) MB 100 D (87-96)</b>								
	MB 100 D		09.87 02.96 - Triebkopf (BM 631.349) <sup>1)</sup>		BA2068			20932 14,0 +/-Zub <b>BDX</b>
<b>MERCEDES BENZ Transporter (BM 901/902) SPRINTER (95-06)</b>								
	208 CDI 208 D 210 D 211 CDI 212 D 213 CDI 214 92 214 105 216 CDI		04.00 05.06 02.95 05.06 01.97 05.06 04.00 05.06 02.95 05.06 04.00 05.06 04.00 05.06 02.95 05.06 04.00 05.06		BA2149 BAV1026	2		21576 20,5 +/-WE Warnkontakt L=80mm <b>ATE</b>
	208 CDI 208 D 210 D 211 CDI 212 D 213 CDI 214 92 214 105 216 CDI		04.00 05.06 02.95 05.06 01.97 05.06 04.00 05.06 02.95 05.06 04.00 05.06 04.00 05.06 02.95 05.06 04.00 05.06		BA2239 BAV1008 BAV1026	2 2	für BA2239 <sup>2)</sup>	29076 20,0 /WE/Zub Warnkontakt L=185mm Warnkontakt L=80mm <b>PER</b>
	208 CDI 208 D 210 D 211 CDI 212 D 213 CDI 214 92 214 105 216 CDI		04.00 05.06 02.95 05.06 01.97 05.06 04.00 05.06 02.95 05.06 04.00 05.06 04.00 05.06 02.95 05.06 04.00 05.06		BAR22161			276 22,0 19,0 V L
	208 CDI 208 D 210 D 211 CDI 212 D 213 CDI 214 92 214 105 216 CDI		04.00 05.06 02.95 05.06 01.97 05.06 04.00 05.06 02.95 05.06 04.00 05.06 04.00 05.06 02.95 05.06 04.00 05.06		BAH0020	2		L=363
	208 CDI (BM 901) 208 D (BM 901) 210 D (BM 901) 211 CDI (BM 901) 212 D (BM 901) 213 CDI (BM 901) 214 (BM 901) 92 214 (BM 901) 105 216 CDI (BM 901)		04.00 05.06 02.95 05.06 01.97 05.06 04.00 05.06 02.95 05.06 04.00 05.06 04.00 05.06 02.95 05.06 04.00 05.06		BA2233 BAV1008	2	für BA2233 <sup>3)</sup>	21621 17,0 +/-WE Warnkontakt L=185mm <b>ATE</b>
	208 CDI (BM 902) 208 D (BM 902) 210 D (BM 902) 211 CDI (BM 902) 212 D (BM 902) 213 CDI (BM 902) 214 (BM 902) 92 214 (BM 902) 105 216 CDI (BM 902)		04.00 05.06 02.95 05.06 01.97 05.06 04.00 05.06 02.95 05.06 04.00 05.06 04.00 05.06 02.95 05.06 04.00 05.06		BA2215 BA2216 BAV1008	2		21592 18,5 +/-WE 23021 18,9 /WE Warnkontakt L=185mm <b>ATE</b> <b>BOS</b>

<sup>1)</sup> - drive head (BM 631.349) / - motrice sola cabina (BM 631.349) / - tête propulsion (BM 631.349) / - grupo matriz (BM 631.349)





<sup>2)</sup> for BA2239 / per BA2239 / pour BA2239 / para BA2239

<sup>3)</sup> for BA2233 / per BA2233 / pour BA2233 / para BA2233

















									
<b>MERCEDES BENZ Transporter (BM 901/902) SPRINTER (95-06)</b>									
	208 CDI (BM 901)		04.00	05.06	BAR12142			258 12,0 10,0 L	
	208 D (BM 901)		02.95	05.06					
	210 D (BM 901)		01.97	05.06					
	211 CDI (BM 901)		04.00	05.06					
	212 D (BM 901)		02.95	05.06					
	213 CDI (BM 901)		04.00	05.06					
	214 (BM 901)		04.00	05.06					
	214 (BM 901)	92	02.95	05.06					
	216 CDI (BM 901)	105	04.00	05.06					
	208 CDI (BM 902)		04.00	05.06					
	208 D (BM 902)		02.95	05.06					
	210 D (BM 902)		01.97	05.06					
	211 CDI (BM 902)		04.00	05.06					
	212 D (BM 902)		02.95	05.06					
213 CDI (BM 902)		04.00	05.06						
214 (BM 902)		04.00	05.06						
214 (BM 902)	92	02.95	05.06						
216 CDI (BM 902)	105	04.00	05.06						
	208 CDI		04.00	05.06	BAH0020	2		L=363	
	208 D		02.95	05.06					
	210 D		01.97	05.06					
	211 CDI		04.00	05.06					
	212 D		02.95	05.06					
	213 CDI		04.00	05.06					
	214		04.00	05.06					
	214	92	02.95	05.06					
	216 CDI	105	04.00	05.06					
	216 CDI		04.00	05.06					
<b>MERCEDES BENZ Transporter (BM 903/904) SPRINTER (95-06)</b>									
	308 CDI		04.00	05.06	BA2149 BAV1026	2		21576 20,5 +/-WE Warnkontakt L=80mm	ATE
	308 D		02.95	05.06					
	310 D		02.95	05.06					
	311 CDI		04.00	05.06					
	312 D		02.95	05.06					
	313 CDI		04.00	05.06					
	314		04.00	05.06					
	314	92	02.95	05.06					
	316 CDI	105	04.00	05.06					
	408 CDI		04.00	05.06					
	408 D		06.95	05.06					
	410 D		09.96	05.06					
	411 CDI		04.00	05.06					
	412 D		06.95	05.06					
	413 CDI		04.00	05.06					
	414		04.00	05.06					
	414	92	06.95	05.06					
	416 CDI	105	04.00	05.06					
	308 CDI		04.00	05.06	BA2239 BAV1008 BAV1026	2 2	für BA2239 1)	29076 20,0 /WE/Zub Warnkontakt L=185mm Warnkontakt L=80mm	PER
	308 D		02.95	05.06					
	310 D		02.95	05.06					
	311 CDI		04.00	05.06					
	312 D		02.95	05.06					
	313 CDI		04.00	05.06					
	314		04.00	05.06					
	314	92	02.95	05.06					
	316 CDI	105	04.00	05.06					
	408 CDI		04.00	05.06					
	408 D		06.95	05.06					
	410 D		09.96	05.06					
	411 CDI		04.00	05.06					
	412 D		06.95	05.06					
	413 CDI		04.00	05.06					
	414		04.00	05.06					
	414	92	06.95	05.06					
	416 CDI	105	04.00	05.06					
	308 CDI		04.00	05.06	BAR22161			276 22,0 19,0 V L	
	308 D		02.95	05.06					
	310 D		02.95	05.06					
	311 CDI		04.00	05.06					
	312 D		02.95	05.06					
	313 CDI		04.00	05.06					
	314		04.00	05.06					
	314	92	02.95	05.06					
	316 CDI	105	04.00	05.06					
	408 CDI		04.00	05.06					
	408 D		06.95	05.06					
	410 D		09.96	05.06					
	411 CDI		04.00	05.06					
	412 D		06.95	05.06					
413 CDI		04.00	05.06						
414		04.00	05.06						
414	92	06.95	05.06						
416 CDI	105	04.00	05.06						
	308 CDI		04.00	05.06	BAR22245			285 22,0 19,0 V L	
	308 D		02.95	05.06					
	310 D		02.95	05.06					
	311 CDI		04.00	05.06					
	311 CDI		04.00	05.06					

1) for BA2239 / per BA2239 / pour BA2239 / para BA2239

























**MERCEDES BENZ Transporter (BM 903/904) SPRINTER (95-06)**

	312 D 313 CDI 314 92 314 105 316 CDI 408 CDI 408 D 410 D 411 CDI 412 D 413 CDI 414 92 414 105 416 CDI		02.95 05.06 04.00 05.06 04.00 05.06 02.95 05.06 04.00 05.06 04.00 05.06 06.95 05.06 09.96 05.06 04.00 05.06 06.95 05.06 04.00 05.06 04.00 05.06 06.95 05.06 04.00 05.06	BAR22245		285 22,0 19,0 V L
	308 CDI 308 D 310 D 311 CDI 312 D 313 CDI 314 92 314 105 316 CDI 408 CDI 408 D 410 D 411 CDI 412 D 413 CDI 414 92 414 105 416 CDI		04.00 05.06 02.95 05.06 02.95 05.06 04.00 05.06 02.95 05.06 04.00 05.06 04.00 05.06 02.95 05.06 04.00 05.06 04.00 05.06 06.95 05.06 09.96 05.06 04.00 05.06 06.95 05.06 04.00 05.06 04.00 05.06 06.95 05.06 04.00 05.06	BAH0020	2	L=363
	308 CDI 308 D 310 D 311 CDI 312 D 313 CDI 314 92 314 105 316 CDI		04.00 05.06 02.95 05.06 02.95 05.06 04.00 05.06 02.95 05.06 04.00 05.06 04.00 05.06 02.95 05.06 04.00 05.06	BA2215 BA2216 BAV1008	2	21592 18,5 +/WE ATE 23021 18,9 /WE BOS Warnkontakt L=185mm
	408 CDI 408 D 410 D 411 CDI 412 D 413 CDI 414 92 414 105 416 CDI		04.00 05.06 06.95 05.06 09.96 05.06 04.00 05.06 06.95 05.06 04.00 05.06 04.00 05.06 06.95 05.06 04.00 05.06	BA2239 BAV1026	2 für BA2239 <sup>2)</sup>	29076 20,0 /WE/Zub PER Warnkontakt L=80mm
	308 CDI 308 D 310 D 311 CDI 312 D 313 CDI 314 92 314 105 316 CDI		04.00 05.06 02.95 05.06 02.95 05.06 04.00 05.06 02.95 05.06 04.00 05.06 04.00 05.06 02.95 05.06 04.00 05.06	BAR16110		272 16,0 14,0 L
	408 CDI 408 D 410 D 411 CDI 412 D 413 CDI 414 92 414 105 416 CDI		04.00 05.06 06.95 05.06 09.96 05.06 04.00 05.06 06.95 05.06 04.00 05.06 04.00 05.06 06.95 05.06 04.00 05.06	BAR22196		285 22,0 19,0 V L
	308 CDI 308 D 310 D 311 CDI 312 D 313 CDI 314 92 314 105 316 CDI 408 CDI 408 D 410 D 411 CDI 412 D 413 CDI 414 92 414 105 416 CDI		04.00 05.06 02.95 05.06 02.95 05.06 04.00 05.06 02.95 05.06 04.00 05.06 04.00 05.06 02.95 05.06 04.00 05.06 04.00 05.06 06.95 05.06 09.96 05.06 04.00 05.06 06.95 05.06 04.00 05.06 06.95 05.06 04.00 05.06	BAH0020	2	L=363

<sup>2)</sup> for BA2239 / per BA2239 / pour BA2239 / para BA2239



















									
<b>MERCEDES BENZ Transporter (BM 905) SPRINTER (01-06)</b>									
	616 CDI		04.01	05.06	BA2239 BAV1008 BAV1026	2 2	für BA2239 1)	29076 20,0 /WE/Zub Warnkontakt L=185mm Warnkontakt L=80mm	PER
	616 CDI		04.01	05.06	BAV1033	2		WK Satz L=239/180mm	
	616 CDI		04.01	05.06	BAR22161			276 22,0 19,0 V L	
	616 CDI		04.01	05.06	BA2124 BAV1034	2		29835 22,0 /WE Warnkontakt L=199/144mm	ATE
<b>MERCEDES BENZ Transporter (BM 906) SPRINTER (06-)</b>									
	209 CDI 210 CDI 211 CDI 213 CDI 215 CDI 216 216 CDI 218 CDI 224 309 CDI 310 CDI 311 CDI 311 CDI 4x4 313 CDI 313 CDI 4x4 315 CDI 315 CDI 4x4 316 316 CDI 316 CDI 4x4 316 NGT 318 CDI 318 CDI 4x4 319 CDI 319 CDI 4x4 324		04.06 03.09 04.06 04.06 04.06 09.08 03.09 04.06 04.06 04.06 04.06 02.08 04.06 06.06 04.06 02.08 09.08 03.09 03.09 09.08 04.06 02.08 03.09 03.09 04.06		BA2281			29192 20,9 /WE/Zub	BRE
	209 CDI 210 CDI 211 CDI 213 CDI 215 CDI 216 216 CDI 218 CDI 224 309 CDI 310 CDI 311 CDI 311 CDI 4x4 313 CDI 313 CDI 4x4 315 CDI 315 CDI 4x4 316 316 CDI 316 CDI 4x4 316 NGT 318 CDI 318 CDI 4x4 319 CDI 319 CDI 4x4 324		04.06 03.09 04.06 04.06 04.06 09.08 03.09 04.06 04.06 04.06 03.09 04.06 02.08 04.06 06.06 04.06 02.08 09.08 03.09 03.09 09.08 04.06 02.08 03.09 03.09 04.06		BA2277 BAV1048	2		29190 19,6 +/WE/S Warnkontakt L=95mm	BOS
<b>MERCEDES BENZ Transporter VARIO (96-)</b>									
	VARIO 512 D VARIO 612 D VARIO 613 D / 614 D VARIO 615 D / 616 D VARIO 618 D VARIO 810 D VARIO 812 D VARIO 813 D / 814 D VARIO 813 DA / 814 DA VARIO 815 D / 816 D VARIO 815 DA / 816 DA VARIO 818 D VARIO 818 DA		09.96 09.96 09.96 09.98 09.96 09.96 09.96 09.96 09.96 09.96 09.96 09.96 09.06		BA2124 BAV1033	2		29835 22,0 /WE WK Satz L=239/180mm	ATE
<b>MG ZR (01-05)</b>									
	105 120 Turbodiesel 160	76 86 74 118	06.01 06.01 06.01 06.01	12.05 12.05 12.05 12.05	BA2010 BA2278			21515 17,5 +/WK 23094 16,5 +/WK/S	LUC LUC



















1) for BA2239 / per BA2239 / pour BA2239 / para BA2239

























																		
<b>MG ZR (01-05)</b>																		
	105 120 Turbodiesel	76 86 74		06.01 06.01 06.01	12.05 12.05 12.05					BAR21105							262 21,0 19,0 V	
	160	118		06.01	12.05					BA2280							21719 15,0 +/WK	AKE
<b>MG ZS (01-05)</b>																		
	120 180 2.0 TD 2.0 TD	86 130 74 83		07.01 07.01 01.04 01.04	12.05 12.05 12.05 12.05					BA2278							23094 16,5 +/WK/S	LUC
<b>MG ZT Limousine (01-05)</b>																		
	2.5 V6 (190) 4.6 V8 (260X)	140 191		06.01 10.03	12.05 12.05					BA2190		+ Scheibe 325X25 <sup>1)</sup>					23183 20,3 +/WE	ATE
	1.8 16V (160) 1.8 T 16V (160) 2.0 CDTi 2.0 CDTi 2.5 V6 (180)	118 118 85 96 130		06.01 01.03 06.02 11.02 01.03	12.05 12.05 09.03 12.05 12.05					BAR22206							284 22,0 19,0 V	
	1.8 16V (160) 1.8 T 16V (160) 2.0 CDTi 2.0 CDTi 2.5 V6 (180) 2.5 V6 (190)	118 118 85 96 130 140		06.01 01.03 06.02 11.02 01.03 06.01	12.05 12.05 09.03 12.05 12.05 12.05					BA2053							20180 17,3 +/WE	ATE
<b>MG ZT-T Kombi (01-05)</b>																		
	2.5 V6 (190) 4.6 V8 (260X)	140 191		10.01 10.03	12.05 12.05					BA2190		+ Scheibe 325X25 <sup>1)</sup>					23183 20,3 +/WE	ATE
	1.8 16V (160) 1.8 T 16V (160) 2.0 CDTi 2.0 CDTi 2.5 V6 (180)	118 118 85 96 130		10.01 01.03 06.02 11.02 01.03	12.05 12.05 09.03 12.05 12.05					BAR22206							284 22,0 19,0 V	
	1.8 16V (160) 1.8 T 16V (160) 2.0 CDTi 2.0 CDTi 2.5 V6 (180) 2.5 V6 (190)	118 118 85 96 130 140		10.01 01.03 06.02 11.02 01.03 10.01	12.05 12.05 09.03 12.05 12.05 12.05					BA2053							20180 17,3 +/WE	ATE
<b>MG MGF (RD) (95-02)</b>																		
	1.6 1.8 i 16V 1.8 i VVC	82 88 107		02.00 03.95 03.95	04.02 04.02 04.02					BA2011							21518 17,0	LUC
<b>MG MG TF (02-05)</b>																		
	115 120 135	85 88 100		03.02 03.02 03.02	12.05 12.05 12.05					BA2011							21518 17,0	LUC
<b>MINI R50/R53 (00-06)</b>																		
	Cooper 1.6 i Cooper S 1.6 i One 1.4 D One 1.4 i One 1.6 i Cooper S JCW 1.6 i	85 66 66 66 66 155		06.00 07.02 03.03 06.00 06.00 11.03	11.06 11.06 11.06 11.06 11.06 02.06					BA2267 BAV1038	1						23281 18,3 +/WE Warnkontakt L=885mm	ATE
	Cooper 1.6 i Cooper S 1.6 i Cooper S JCW 1.6 i One 1.4 D One 1.4 i One 1.6 i	85 155 155 66 66 66		06.00 07.02 11.03 03.03 06.00 06.00	11.06 11.06 11.06 11.06 11.06 11.06					BA2272 BAV1039	1						23716 16,3 +/WE Warnkontakt L=1095mm	ATE
<b>MINI R52 Cabrio (04-08)</b>																		
	Cooper 1.6 i Cooper S 1.6 i One 1.6 i Cooper S Works 1.6 i	85 125 66 155		04.04 04.04 04.04 11.03	08.08 08.08 08.08 05.06					BA2267 BAV1038	1						23281 18,3 +/WE Warnkontakt L=885mm	ATE
	Cooper 1.6 i Cooper S 1.6 i Cooper S Works 1.6 i One 1.6 i	85 125 155 66		04.04 04.04 11.03 04.04	08.08 08.08 08.08 08.08					BA2272 BAV1039	1						23716 16,3 +/WE Warnkontakt L=1095mm	ATE
<b>MINI R55 Clubman (07-)</b>																		
	Cooper Cooper D Cooper SD One One D	105 66		09.07 09.07 02.11 03.10 03.10						BA2307 BAV1044	1						23915 17,8 +/WE/S Warnkontakt L=805mm	LUC

1) + disc 325X25 / + disco 325X25 / + disque 325X25 / + disco 325X25

2) + disc 284X22 / + disco 284X22 / + disque 284X22 / + disco 284X22





















	   kW							
<b>MINI R55 Clubman (07-)</b>								
	Cooper S		09.07		BAV1044	1		Warnkontakt L=805mm
	John Cooper Works	155	03.08		BAV1044	1		Warnkontakt L=805mm
	Cooper		09.07		BAV1045	1		Warnkontakt L=1125mm
	Cooper D		09.07					
	Cooper S		09.07					
	Cooper SD	105	02.11					
	John Cooper Works	155	03.08					
	One		03.10					
One D	66	03.10						
<b>MINI R56 (06-)</b>								
	Cooper	85	03.10		BA2307 BAV1044	1		23915 17,8 +/-WE/S LUC Warnkontakt L=805mm
	Cooper	88	11.06					
	Cooper	90	03.10					
	Cooper D		04.07					
	Cooper SD		02.11					
	One	55	03.09					
	One	70	04.07					
	One	72	03.10					
	One D	66	03.10					
		Cooper S		03.10				
Cooper S		128	11.06					
Cooper S		147	01.12					
John Cooper Works		155	03.08					
John Cooper Works	160	07.07						
	Cooper	85	03.10		BAV1045	1		Warnkontakt L=1125mm
	Cooper	88	11.06					
	Cooper	90	03.10					
	Cooper D		04.07					
	Cooper S		03.10					
	Cooper S	128	11.06					
	Cooper S	147	01.12					
	Cooper SD		02.11					
	John Cooper Works	155	03.08					
	John Cooper Works	160	07.07					
	One	55	03.09					
	One	70	04.07					
	One	72	03.10					
	One D	66	03.10					
<b>MINI R57 Cabrio (09-)</b>								
	Cooper		01.09		BA2307 BAV1044	1		23915 17,8 +/-WE/S LUC Warnkontakt L=805mm
	Cooper	90	03.10					
	Cooper D	82	08.10					
	Cooper SD	105	02.11					
	One	72	03.10					
	Cooper S		03.10					
Cooper S	128	01.09						
John Cooper Works	155	03.09						
	Cooper		01.09		BAV1045	1		Warnkontakt L=1125mm
	Cooper	90	03.10					
	Cooper D	82	08.10					
	Cooper S		03.10					
	Cooper S	128	01.09					
	Cooper SD	105	02.11					
	John Cooper Works	155	03.09					
	One	72	03.10					
<b>MINI R58 Coupé (11-)</b>								
	Cooper		10.11		BA2307			23915 17,8 +/-WE/S LUC
	Cooper SD		10.11					
<b>MINI R59 Roadster (12-)</b>								
	Cooper		02.12		BA2307			23915 17,8 +/-WE/S LUC
	Cooper SD		02.12					
<b>MINI R60 Countryman (10-)</b>								
	Cooper	90	09.10		BA2308			23623 17,4 +/-WE/S LUC
	Cooper D	82	09.10					
	Cooper S	135	09.10					
	Cooper S	147	02.12					
	Cooper S All4		09.10					
	Cooper SD	105	02.11					
	Cooper SD All4		02.11					
	Cooper D All4	82	09.10					
	One	72	09.10					
	One D	66	09.10					

											
<b>MITSUBISHI CARISMA (95-06)</b>											
	1.6 i 16V (DA1A)	76	06.99	08.00	BA2268			21920 15,1 /WK/S LUC			
	1.8 i (DA2A)	85	07.95	06.98							
	1.8 i 16V (DA2A)	103	07.95	06.98							
	1.8 i 16V GDI (DA2A)	92	09.97	08.00							
	1.9 TD (DA4A)	66	03.99	08.00							
	1.3 i (DA6A)	55	09.00	10.04					BA2237		21983 17,3 /WK/Zub LUC
	1.6 i 16V (DA1A)	76	09.00	10.05							
	1.8 i (DA2A)	85	07.98	10.05							
	1.8 i 16V (DA2A)	103	07.98	10.05							
	1.8 i 16V GDI (DA2A)	90	10.00	10.05							
1.8 i 16V GDI (DA2A)	92	09.00	06.06								
1.9 DI-D (DA5A)	75	09.00	06.06								
1.9 DI-D (DA5A)	85	09.00	06.06								
	1.6 i 16V (DA1A)	76	06.99	08.00	BAR24136		256 24,0 21,5 V				
	1.8 i (DA2A)	85	07.95	02.99							
	1.8 i 16V (DA2A)	103	07.95	02.99							
	1.8 i 16V GDI (DA2A)	92	09.97	08.00							
	1.9 TD (DA4A)	66	03.99	08.00							
	1.3 i (DA6A)	55	09.00	10.04				BAR24159		281 24,0 21,5 V	
	1.6 i 16V (DA1A)	76	09.00	10.05							
	1.8 i (DA2A)	85	03.99	10.05							
	1.8 i 16V (DA2A)	103	03.99	10.05							
	1.8 i 16V GDI (DA2A)	90	10.00	10.05							
1.8 i 16V GDI (DA2A)	92	09.00	06.06								
1.9 DI-D (DA5A)	75	09.00	06.06								
1.9 DI-D (DA5A)	85	09.00	06.06								
	1.3 i (DA6A)	55	09.00	10.04	BA2226		21861 15,3 /WK/S LUC				
	1.6 i (DA1A)	66	06.99	06.06 + ABS							
	1.6 i 16V (DA1A)	76	09.00	10.05 + ABS							
	1.8 i (DA2A)	85	11.97	10.05 + ABS							
	1.8 i 16V (DA2A)	103	11.97	10.05 + ABS							
	1.8 i 16V GDI (DA2A)	90	10.00	10.05 + ABS							
	1.8 i 16V GDI (DA2A)	92	06.99	10.05 + ABS							
	1.9 DI-D (DA5A)	75	09.00	06.06							
	1.9 DI-D (DA5A)	85	09.00	06.06							
		1.3 i (DA6A)	55	09.00				10.04	BAR10229		260 10,0 8,4
1.6 i (DA1A)		66	06.99	06.06 + ABS							
1.6 i 16V (DA1A)		76	09.00	10.05 + ABS							
1.8 i (DA2A)		85	07.95	10.05 + ABS							
1.8 i 16V (DA2A)		103	07.95	10.05 + ABS							
1.8 i 16V GDI (DA2A)		90	10.00	10.05 + ABS							
1.8 i 16V GDI (DA2A)		92	08.97	10.05 + ABS							
1.9 DI-D (DA5A)		75	09.00	06.06							
1.9 DI-D (DA5A)		85	09.00	06.06							
<b>MITSUBISHI COLT/LANCER Limousine (88-92)</b>											
	1.6 16V (C66A)		06.92	10.92 + ABS	BA2117		21647 16,0 +/-WK SUM				
	1.8 GTi 16V (C58A)		11.89	05.92							
	1.8 GTi 16V (C68A)		11.89	05.92							
	1.8 GTi 16V (C69A)		06.92	10.92							
<b>MITSUBISHI COLT/LANCER Limousine (92-96)</b>											
	1.8 16V GTi (CA5A)		12.91	04.96	BA2117		21647 16,0 +/-WK SUM				
	1.8 16V GTi (CB5A)		05.92	04.96							
<b>MITSUBISHI COLT (04-)</b>											
	1.1 i 12V (Z32A)	55	10.04		BA2268		21920 15,1 /WK/S LUC				
	1.3 i 16V (Z34A)	70	06.04								
	1.5 DI-D (Z38A)	50	08.04								
	1.5 DI-D (Z39A)	70	08.04								
	1.5 i 16V (Z27A)	72	09.04	02.06							
	1.5 i 16V (Z36A)	80	06.04								
	1.5 CZT (Z37A)	110	03.05	08.08	BA2237		21983 17,3 /WK/Zub LUC				
	1.5 i 16V (Z37A)	132	05.07	08.08							
	1.1 i 12V (Z32A)	55	10.04					BAR24192		256 24,0 21,5 V	
1.3 i 16V (Z34A)	70	06.04									
1.5 DI-D (Z38A)	50	08.04									
1.5 DI-D (Z39A)	70	08.04									
1.5 i 16V (Z27A)	72	09.04	02.06								
1.5 i 16V (Z36A)	80	06.04									
	1.1 i 12V (Z32A)	55	10.04	+ ABS	BA2226		21861 15,3 /WK/S LUC				
	1.3 i 16V (Z34A)	70	06.04	+ ABS							
	1.5 CZT (Z37A)	110	03.05								
	1.5 DI-D (Z38A)	50	08.04	+ ABS							
	1.5 DI-D (Z39A)	70	08.04	+ ABS							
	1.5 i 16V (Z27A)	72	09.04	02.06							
	1.5 i 16V (Z36A)	80	06.04								
	1.5 i 16V (Z37A)	132	05.07								
	1.1 i 12V (Z32A)	55	10.04	+ ABS	BAR10304		250 10,0 8,0				
	1.3 i 16V (Z34A)	70	06.04	+ ABS							
	1.5 CZT (Z37A)	110	03.05								
	1.5 DI-D (Z38A)	50	08.04	+ ABS							
	1.5 DI-D (Z39A)	70	08.04	+ ABS							
	1.5 i 16V (Z27A)	72	09.04	02.06							
	1.5 i 16V (Z36A)	80	06.04								

								
<b>MITSUBISHI COLT (04-)</b>								
	1.5 i 16V (Z37A)	132		05.07		BAR10304		250 10,0 8,0
<b>MITSUBISHI COLT CZC Cabriolet (06-08)</b>								
	1.5 i 16V (Z36A)	80		05.06	07.08	BA2268		21920 15,1 /WK/S LUC
	1.5 Turbo (Z37A)	110		05.06	07.08	BA2237		21983 17,3 /WK/Zub LUC
	1.5 i 16V (Z36A)	80		05.06	07.08	BAR24192		256 24,0 21,5 V
	1.5 i 16V (Z36A)	80		05.06	07.08	BA2226		21861 15,3 /WK/S LUC
	1.5 Turbo (Z37A)	110		05.06	07.08			
	1.5 i 16V (Z36A)	80		05.06	07.08	BAR10304		250 10,0 8,0
	1.5 Turbo (Z37A)	110		05.06	07.08			
<b>MITSUBISHI ECLIPSE I (91-95)</b>								
	2.0 16V (D22A)	110		04.91	11.95	BA2117		21647 16,0 +/WK SUM
<b>MITSUBISHI ECLIPSE II (95-99)</b>								
	2.0 GS 16V	107		12.95	04.99	BA2117		21647 16,0 +/WK SUM
	2.0 GT 16V	157		12.95	04.99			
<b>MITSUBISHI GALANT (4-türig) (87-92)</b>								
	1.8 (E32A)			06.90	10.92	BA2117		21647 16,0 +/WK SUM
	1.8 TD (E34A)			06.90	10.92			
	2.0 (E33A)			06.90	10.92			
	2.0 4x4 (E38A)			06.90	10.92			
	2.0 4x4 (E39A)			06.90	05.91 + SOHC			
	1.8 (E32A)			10.89	05.90	BAR24136	+ 14" Rad <sup>1)</sup>	256 24,0 21,5 V
	1.8 (E32A)			06.90	10.92 - ABS			
	1.8 TD (E34A)			06.90	10.92			
	2.0 (E33A)			06.90	10.92 - ABS			
	2.0 4x4 (E38A)			06.90	10.92 - ABS			
	2.0 4x4 (E39A)			06.90	05.91 + SOHC			
<b>MITSUBISHI GALANT (5-türig) (88-92)</b>								
	1.8 (E32A)			06.90	10.92	BA2117		21647 16,0 +/WK SUM
	1.8 TD (E34A)			06.90	10.92			
	2.0 (E33A)			06.90	10.92			
	2.0 4x4 (E38A)			06.90	10.92			
	2.0 4x4 (E39A)			06.90	05.91 + SOHC			
	1.8 (E32A)			10.89	05.90	BAR24136		256 24,0 21,5 V
	1.8 (E32A)			06.90	10.92 - ABS			
	1.8 TD (E34A)			06.90	10.92			
	2.0 (E33A)			06.90	10.92 - ABS			
	2.0 4x4 (E38A)			06.90	10.92 - ABS			
	2.0 4x4 (E39A)			06.90	05.91 + SOHC			
<b>MITSUBISHI GALANT (92-96)</b>								
	1.8 (E52A)			11.92	09.96	BA2117		21647 16,0 +/WK SUM
	2.0 (E55A)			11.92	09.96			
	2.0 4x4 (E75A)			11.92	09.96			
	2.0 i V6 (E54A)			11.92	09.96			
	2.0 i V6 4WS (E64A)			11.92	09.96			
	2.0 TD (E57A)			11.92	09.96			
	1.8 (E52A)			11.92	09.96	BAR24136		256 24,0 21,5 V
	2.0 (E55A)			11.92	09.96			
	2.0 4x4 (E75A)			11.92	09.96			
	2.0 i V6 (E54A)			11.92	09.96			
	2.0 i V6 4WS (E64A)			11.92	09.96			
	2.0 TD (E57A)			11.92	09.96			
<b>MITSUBISHI GALANT (96-03)</b>								
	2.0 i 16V (EA2)	100		10.96	11.97	BA2117		21647 16,0 +/WK SUM
	2.0 i 16V (EA2W)	100		10.96	11.97			
	2.0 TDi (EA6)	66		10.96	07.01			
	2.5 i V6 (EA5)	120		10.96	11.97			
	2.0 i 16V (EA2)	100		12.97	03.00	BA2249		21363 16,0 +/WK AKE
	2.0 i 16V (EA2W)	100		12.97	03.00			
	2.4 GDi (EA3)	110		03.99	03.00			
	2.5 i V6 (EA5)	120		12.97	03.00			
	2.0 i 16V (EA2)	100		10.96	11.97	BAR24136		256 24,0 21,5 V
	2.0 i 16V (EA2W)	100		10.96	11.97			
	2.0 TDi (EA6)	66		10.96	07.01			
	2.5 i V6 (EA5)	120		10.96	11.97			
	2.0 i 16V (EA2)	100		12.97	03.00	BAR24170		276 24,0 22,4 V
	2.0 i 16V (EA2W)	100		12.97	03.00			
	2.4 GDi (EA3)	110		03.99	03.00			
	2.5 i V6 (EA5)	120		12.97	03.00			

<sup>1)</sup> + 14" wheel / + ruota 14" / + roue 14" / + rueda 14"



										
<b>mitsubishi L 200 (86-96)</b>										
	1.6 (K11T)	60		04.87	05.92		BA2112		21373 16,0 +/-WK	SUM
	2.0 (K12T)	75		11.86	08.96					
	2.0 4WD (K32T)	75		11.86	05.92					
	2.5 D (K14T)	51		11.86	08.96					
	2.5 D 4WD (K24T)	51		12.87	05.93					
	2.5 TD 4WD (K34T)	64		11.92	04.93					
	2.5 TD 4WD (K34T)	64		05.93	08.96	- Servolenkung <sup>1)</sup>				
	2.5 TD 4WD (K34T)	64		05.93	08.96	+ Servolenkung <sup>2)</sup>	BA2249		21363 16,0 +/-WK	AKE
<b>mitsubishi L 200 (96-06)</b>										
	2.4 i 4WD (K75T)	97		01.99	07.01	+ ABS	BA2249		21363 16,0 +/-WK	AKE
	2.5 D (K64T)	55		06.00	07.01	+ ABS				
	2.5 TD 4WD (K74T)	73		06.96	07.01	+ ABS				
<b>mitsubishi L 300 (86-94)</b>										
	1.6 (L032P)			11.88	05.94		BA2112		21373 16,0 +/-WK	SUM
	1.6 (P02V)			11.88	05.94					
	1.6 (P12V)			11.88	05.94					
	2.0 (P03V)			11.86	05.94					
	2.0 (P03W)			11.86	05.94					
	2.0 (P13V)			11.86	05.94					
	2.0 4WD (P23V)			07.88	10.92					
	2.0 4WD (P23W)			11.86	10.92					
	2.4 (P04V/W/P14V)			11.90	05.94					
	2.4 4WD (P24V)			07.88	05.94					
	2.4 4WD (P24W)			11.86	05.94					
	2.5 D (L039P)			11.88	05.94					
	2.5 D (P05V/W)			11.86	05.94					
	2.5 D (P15V)			11.86	05.94					
	2.5 D 4WD(P25W/P25V)			12.87	05.94					
<b>mitsubishi L 400 (96-02)</b>										
	2.4	97		06.96	10.02		BA2249		21363 16,0 +/-WK	AKE
	2.5 TD	64		06.96	10.02	+ ABS				
	2.5 TD 4x4	64		09.96	10.02	+ ABS				
<b>mitsubishi LANCER Evolution (04-07)</b>										
	2.0 i 16V 4WD (CT9A)	195		03.04	12.05		BA2249		21363 16,0 +/-WK	AKE
<b>mitsubishi LANCER Kombi (92-96)</b>										
	1.6 16V 4WD (GD4W)	83		06.92	02.95		BA2117		21647 16,0 +/-WK	SUM
	1.6 16V 4WD (GD4W)	83		06.92	02.95		BAR24136		256 24,0 21,5 V	
<b>mitsubishi OUTLANDER I (03-)</b>										
	2.0 i 16V	100		05.03			BA2249		21363 16,0 +/-WK	AKE
	2.0 i 16V 4WD	100		05.03						
	2.0 i 16V Turbo 4WD	148		04.04						
	2.4 i 16V 4WD	102		05.03						
	2.4 i 16V 4WD	118		11.03						
	2.4 Mivec	118		11.03	09.06					
<b>mitsubishi OUTLANDER II (06-)</b>										
	2.0 DI-D	103		01.07			BA2249		21363 16,0 +/-WK	AKE
	2.0 i 16V	100		01.07						
	2.2 DI-D	115		08.07	05.08					
	2.2 DI-D 4x4	115		08.07	05.08					
	2.4 i 16V	125		11.06						
	2.4 i 16V 4x4	118		01.07						
	2.4 Mivec 4x4	125		09.07						
<b>mitsubishi PAJERO (90-00)</b>										
	2.4 (V21C/V21W)			12.90	03.00		BA2249		21363 16,0 +/-WK	AKE
	2.4 (V41W)			12.90	03.00					
	2.5 TD (V24C/V24W)			12.90	03.00					
	2.5 TD (V44W)			12.90	03.00					
	2.8 TD (V26W)			11.93	03.00					
	2.8 TD (V46W)			11.93	03.00					
	3.0 V6 (V23C/V23W)			12.90	03.00					
	3.0 V6 (V43W)			12.90	03.00					
	3.5 V6 (V25W)			11.93	03.00					
	3.5 V6 (V45W)			11.93	03.00					
<b>mitsubishi PAJERO (00-06)</b>										
	2.5 TDiC (V64W)	73		04.00	10.03		BA2249		21363 16,0 +/-WK	AKE
	2.5 TDiC (V64W)	85		04.00	10.03					
	3.2 DiD (V68W)	118		10.01	08.06					
	3.2 DiD (V68W)	121		04.00	09.01					
	3.5 i V6 GDI (V65W)	149		04.00	08.06					

<sup>1)</sup> - power steering / - servosterzo / - direction assistée / - dirección asistida  
<sup>2)</sup> + power steering / + servosterzo / + direction assistée / + dirección asistida

<b>MITSUBISHI PAJERO SPORT / MONTERO (USA) (98-)</b>								
	2.5 TDCi (K94W)	73	11.98	06.02	BA2249			21363 16,0 +/WK AKE
	2.5 TDCi (K94W)	85	07.02					
	2.5 TDCi (K94W)	98	08.03					
	3.0 i V6 (K96W)	125	06.00					
	3.0 i V6 (K96W)	130	11.98	09.01				
<b>MITSUBISHI SANTAMO (99-03)</b>								
	2.0 i 16V	102	05.99	10.03	BA2117			21647 16,0 +/WK SUM
	2.0 i 16V 4WD	102	05.99	10.03				
	2.0 i 16V	102	05.99	10.03 - ABS	BAR24136			256 24,0 21,5 V
	2.0 i 16V 4WD	102	05.99	10.03 - ABS				
	2.0 i 16V	102	05.99	10.03 + ABS	BAR24146			256 24,0 22,4 V
	2.0 i 16V 4WD	102	05.99	10.03 + ABS				
<b>MITSUBISHI SPACE GEAR (95-00)</b>								
	2.4 i 4x4	97	05.95	05.00	BA2249			21363 16,0 +/WK AKE
	2.5 TDiC 4x4	73	05.95	05.00				
<b>MITSUBISHI SPACE RUNNER (91-99)</b>								
	1.8 (N11W)		06.91	08.99	BA2117			21647 16,0 +/WK SUM
	1.8 4x4 (N21W)		06.91	08.99				
	2.0 TD (N18W)		06.92	08.99				
	1.8 (N11W)		06.91	08.99 - ABS/ + HA-Trommelbremse 1)	BAR24136			256 24,0 21,5 V
	1.8 4x4 (N21W)		06.91	08.99 - ABS/ + HA-Trommelbremse 1)				
	2.0 TD (N18W)		06.92	08.99 - ABS				
	1.8 (N11W)		06.91	08.99 + ABS/ + HA-Scheibenbremse 2)	BAR24146			256 24,0 22,4 V
	1.8 4x4 (N21W)		06.91	08.99 + ABS/ + HA-Scheibenbremse 2)				
<b>MITSUBISHI SPACE RUNNER (99-03)</b>								
	2.0 i 16V (N63W)	100	09.99	04.00	BA2249			21363 16,0 +/WK AKE
	2.4 16V GDI (N64W)	110	09.99	04.00				
<b>MITSUBISHI SPACE STAR (98-06)</b>								
	1.3 i (DG1A)	60	08.00	03.06	BA2268			21920 15,1 /WK/S LUC
	1.3 i (DG1A)	61	12.98	03.06				
	1.3 i (DG1A)	63	06.98	07.00				
	1.6 i 16V (DG3A)	72	09.01	03.06				
	1.8 GDI (DG5A)	82	10.02	03.06				
	1.8 GDI (DG5A)	90	06.98	03.06				
	1.9 DI-D (DG4A)	75	02.01	03.06				
	1.9 DI-D (DG4A)	85	10.02	03.06				
	1.3 i (DG1A)	60	08.00	03.06	BAR24136			256 24,0 21,5 V
	1.3 i (DG1A)	61	12.98	03.06				
	1.3 i (DG1A)	63	06.98	07.00				
	1.6 i 16V (DG3A)	72	09.01	03.06				
	1.8 GDI (DG5A)	82	10.02	03.06				
	1.8 GDI (DG5A)	90	06.98	03.06				
	1.9 DI-D (DG4A)	75	02.01	03.06				
	1.9 DI-D (DG4A)	85	10.02	03.06				
	1.3 i (DG1A)	60	08.00	03.06 + ABS	BA2226			21861 15,3 /WK/S LUC
	1.3 i (DG1A)	61	12.98	03.06 + ABS				
	1.3 i (DG1A)	63	06.98	07.00 + ABS				
	1.6 i 16V (DG3A)	72	09.01	03.06				
	1.8 GDI (DG5A)	82	10.02	03.06 + ABS				
	1.8 GDI (DG5A)	90	06.98	03.06 + ABS				
	1.9 DI-D (DG4A)	75	02.01	03.06				
	1.9 DI-D (DG4A)	85	10.02	03.06				
	1.3 i (DG1A)	60	08.00	03.06 + ABS	BAR10229			260 10,0 8,4
	1.3 i (DG1A)	61	12.98	03.06 + ABS				
	1.3 i (DG1A)	63	06.98	07.00 + ABS				
	1.6 i 16V (DG3A)	72	09.01	03.06				
	1.8 GDI (DG5A)	82	10.02	03.06 + ABS				
	1.8 GDI (DG5A)	90	06.98	03.06 + ABS				
	1.9 DI-D (DG4A)	75	02.01	03.06				
	1.9 DI-D (DG4A)	85	10.02	03.06				
<b>MITSUBISHI SPACE WAGON (91-98)</b>								
	1.8 (N31W)		05.91	05.92	BA2117			21647 16,0 +/WK SUM
	1.8 4x4 (N41W)		05.91	05.92				
	1.8 TD (N35W)		05.91	05.92				
	2.0 (N33W)		06.92	10.98				
	2.0 4x4 (N43W)		06.92	10.98				
	2.0 TD (N38W)		06.92	10.98				
	2.4 (N34W)		06.92	05.96				
	1.8 (N31W)		05.91	05.92 + HA-Trommelbremse 3)	BAR24136			256 24,0 21,5 V
	1.8 4x4 (N41W)		05.91	05.92 + HA-Trommelbremse 3)				
	1.8 TD (N35W)		05.91	05.92 + HA-Trommelbremse 3)				
	2.0 (N33W)		06.92	10.98 + HA-Trommelbremse 3)				
	2.0 4x4 (N43W)		06.92	10.98 + HA-Trommelbremse 3)				
	2.0 TD (N38W)		06.92	10.98 + HA-Trommelbremse 3)				
	2.4 (N34W)		06.92	05.96 + HA-Trommelbremse 3)				
	1.8 (N31W)		05.91	05.92 + HA-Scheibenbremse 4)	BAR24146			256 24,0 22,4 V
	1.8 4x4 (N41W)		05.91	05.92 + HA-Scheibenbremse 4)				

1) - ABS/ + RA drum brake / - ABS/ + P freno a tamburo / - ABS/ + fr. à tambour essieu AR / - ABS/ + ET tambores de freno

2) + ABS/ + RA disc brake / + ABS/ + P disco freno / + ABS/ + fr. à disque essieu AR / + ABS/ + ET disco de freno





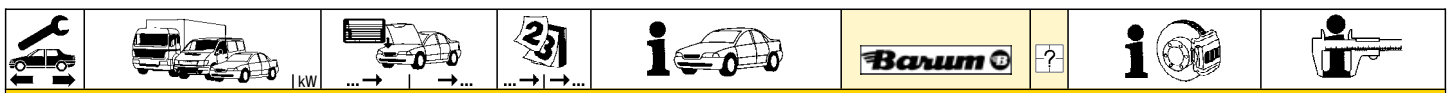













3) + RA drum brake / + P freno a tamburo / + frein à tambour essieu AR / + ET-tambores de freno

4) + RA disc brake / + P disco freno / + frein à disque essieu AR / + ET-disco de freno













































MITSUBISHI SPACE WAGON (91-98)									
	1.8 TD (N35W) 2.0 (N33W) 2.0 4x4 (N43W) 2.0 TD (N38W) 2.4 (N34W)		05.91 06.92 06.92 06.92 06.92	05.92 10.98 10.98 10.98 05.96	+ HA-Scheibenbremse <sup>1)</sup> + HA-Scheibenbremse <sup>1)</sup> + HA-Scheibenbremse <sup>1)</sup> + HA-Scheibenbremse <sup>1)</sup> + HA-Scheibenbremse <sup>1)</sup>	BAR24146			256 24,0 22,4 V
MITSUBISHI SPACE WAGON (98-05)									
	2.0 GDi (N83W) 2.0 GLX (N83W) 2.4 GDi (N84W) 2.4 GDi (N84W) 2.4 GDi 4x4 (N94W) 2.4 GDi 4x4 (N94W)	98 80 108 110 108 110	05.02 10.98 09.00 10.98 09.00 10.98	08.05 04.02 08.03 08.03 08.03 08.03		BA2249			21363 16,0 +/-WK AKE
NISSAN 100 NX (B13) (90-94)									
	1.6		10.90	10.94		BA2113			21659 16,4 +/-WK SUM
	1.6		10.90	10.94		BAR18107			240 18,0 16,0 V
NISSAN ALMERA (N16) (00-06)									
	1.5 dCi 1.5 i 1.5 i 1.5 i 1.8 i 1.8 i 1.8 i 1.8 i 2.2 dCi 2.2 dCi 2.2 Di 2.2 Di	60 66 66 72 84 84 85 82 100 81 81	01.03 02.00 03.00 10.02 02.00 03.00 10.02 09.03 09.03 02.00 03.00	11.06 11.06 03.01 11.06 11.06 03.01 11.06 11.06 11.06 11.06 03.01	+ ABS + ABS + ABS/ Herst.Land <sup>2)</sup> + ABS Herst.Land <sup>3)</sup> Herst.Land <sup>3)</sup> Herst.Land <sup>3)</sup>	BA2273			23463 16,6 + LUC
	1.5 dCi 1.5 i 1.5 i 1.8 i 1.8 i 2.2 dCi 2.2 dCi 2.2 Di	60 66 72 84 85 82 100 81	01.03 02.00 10.02 02.00 10.02 09.03 09.03 02.00	11.06 11.06 11.06 11.06 11.06 11.06 11.06 11.06	+ ABS + ABS + ABS Herst.Land <sup>3)</sup>	BA2227			21545 14,9 LUC
	1.5 dCi 1.5 i 1.5 i 1.8 i 1.8 i 1.8 i 2.2 dCi 2.2 dCi 2.2 Di 2.2 Di	60 66 72 84 84 85 82 100 81 81	01.03 02.00 03.00 10.02 02.00 03.00 10.02 09.03 09.03 02.00 03.00	11.06 11.06 03.01 11.06 11.06 03.01 11.06 11.06 11.06 11.06 03.01	+ ABS + ABS + ABS/ Herst.Land <sup>2)</sup> + ABS Herst.Land <sup>3)</sup> Herst.Land <sup>3)</sup>	BAR10215			258 10,0 9,0
NISSAN ALMERA TINO (V10M) (00-05)									
	1.6 i 16V 1.8 i 16V 2.0 i 16V 2.2 Di	71 84 100 84	08.00 08.00 08.00 08.00	01.03 01.03 01.03 01.03	- <sup>2)</sup>	BA2278			23094 16,5 +/-WK/S LUC
	1.6 i 16V 1.8 i 16V 1.8 i 16V 2.0 i 16V 2.2 dCi 2.2 dCi 2.2 Di	71 84 85 100 82 100 84	02.03 02.03 12.02 02.03 09.03 09.03 02.03	11.05 11.05 11.05 08.03 11.05 11.05 08.03	- <sup>2)</sup>	BA2278			23094 16,5 +/-WK/S LUC
	1.6 i 16V 1.8 i 16V 1.8 i 16V 2.0 i 16V 2.2 dCi 2.2 dCi 2.2 Di	71 84 85 100 82 100 84	08.00 08.00 12.02 08.00 09.03 09.03 08.00	11.05 11.05 11.05 08.03 11.05 11.05 08.03	- <sup>2)</sup>	BAR28140			280 28,0 26,0 V
	1.6 i 16V 1.8 i 16V 1.8 i 16V 2.0 i 16V 2.2 dCi 2.2 dCi 2.2 Di	71 84 85 100 82 100 84	08.00 08.00 12.02 08.00 09.03 09.03 08.00	11.05 11.05 11.05 08.03 11.05 11.05 08.03	- <sup>2)</sup>	BA2227			21545 14,9 LUC
	1.6 i 16V 1.8 i 16V 1.8 i 16V 2.0 i 16V 2.2 dCi 2.2 dCi	71 84 85 100 82 100	08.00 08.00 12.02 08.00 09.03 09.03	11.05 11.05 11.05 08.03 11.05 11.05	- <sup>2)</sup>	BAR10285			278 10,0 9,0























1) + RA disc brake / + P disco freno / + frein à disque essieu AR / + ET-disco de freno  
2) + ABS/ country of manufacture <sup>2)</sup> / + ABS/ paese del costruttore <sup>2)</sup> / + ABS/ pays du constructeur <sup>2)</sup>  
<sup>2)</sup> / + ABS/ país del fabricante <sup>2)</sup>  
3) country of manufacture <sup>3)</sup> / paese del costruttore <sup>3)</sup> / pays du constructeur <sup>3)</sup> / país del fabricante <sup>3)</sup>

								
<b>NISSAN ALMERA TINO (V10M) (00-05)</b>								
	2.2 Di	84	08.00	08.03	BAR10285			278 10,0 9,0
<b>NISSAN INTERSTAR (X70) (02-)</b>								
	1.9 dCi	60	07.02	08.06	BA2251			23613 17,8 BOS
	2.2 dCi	66	07.02	08.06				
	2.5 dCi	73	11.03					
	2.5 dCi	74	04.06					
	2.5 dCi	84	07.02	08.06				
	2.5 dCi	88	09.06					
	2.5 dCi	107	09.06					
	3.0 dCi	100	11.03	08.06				
	1.9 dCi	60	07.02	08.06	BAR28129			306 28,0 25,0 V
	2.2 dCi	66	07.02	08.06				
	2.5 dCi	73	11.03					
	2.5 dCi	74	04.06					
	2.5 dCi	84	07.02	08.06				
	2.5 dCi	88	09.06					
	2.5 dCi	107	09.06					
	3.0 dCi	100	11.03	08.06				
	1.9 dCi	60	07.02	08.06	BA2261			23669 16,8 /S BOS
	2.2 dCi	66	07.02	08.06				
	2.5 dCi	73	11.03					
	2.5 dCi	74	04.06					
	2.5 dCi	84	07.02	08.06				
	2.5 dCi	88	09.06					
	2.5 dCi	107	09.06					
	3.0 dCi	100	11.03	08.06				
<b>NISSAN KUBISTAR (X76) Kombi (03-)</b>								
	1.2	44	08.03	08.05	BA2090			21980 18,0 +/-WE/S BOS
	1.2	55	08.03					
	1.5 dCi	42	08.03	08.05				
	1.5 dCi	44	09.05					
	1.5 dCi	48	08.03	08.05				
	1.5 dCi	51	09.05					
	1.5 dCi	60	08.03	08.05				
	1.5 dCi	66	09.05					
1.6 i 16V	70	08.03						
	1.2	44	08.03	08.05	BAR21106			259 20,6 17,7 V
	1.2	55	08.03					
	1.5 dCi	42	08.03	08.05				
	1.5 dCi	44	09.05					
	1.5 dCi	48	08.03	08.05				
	1.5 dCi	51	09.05					
	1.5 dCi	60	08.03	08.05				
	1.5 dCi	66	09.05					
1.6 i 16V	70	08.03						
	1.2	44	08.03	08.05	BAR20125			238 20,0 17,7 V
	1.2	55	08.03					
	1.5 dCi	42	08.03	08.05				
	1.5 dCi	44	09.05					
	1.5 dCi	48	08.03	08.05				
	1.5 dCi	51	09.05					
	1.5 dCi	60	08.03	08.05				
	1.5 dCi	66	09.05					
1.6 i 16V	70	08.03						
	1.2	44	08.03	08.05	BAW2207		+ 8" Bremse <sup>1)</sup>	Rz 22,00
	1.2	55	08.03					
	1.5 dCi	42	08.03	08.05				
	1.5 dCi	44	09.05					
	1.5 dCi	48	08.03	08.05				
	1.5 dCi	51	09.05					
	1.5 dCi	60	08.03	08.05				
	1.5 dCi	66	09.05					
1.6 i 16V	70	08.03						
	1.2	44	08.03	08.05	BAE5017		+ 8" Bremse <sup>1)</sup>	203 x 39 HEB
	1.2	55	08.03					
	1.5 dCi	42	08.03	08.05				
	1.5 dCi	44	09.05					
	1.5 dCi	48	08.03	08.05				
	1.5 dCi	51	09.05					
	1.5 dCi	60	08.03	08.05				
	1.5 dCi	66	09.05					
1.6 i 16V	70	08.03						
<b>NISSAN MAXIMA (CA33) (00-06)</b>								
	2.0 i V6	103	03.00	01.06	BAR28140			280 28,0 26,0 V
	2.5 i V6	154	03.00	01.06				
	3.0 i V6	147	03.00	01.06				





















<sup>1)</sup> + 8" brake / + servofreno da 8" / + frein de 8" / + freno de 8"

									
<b>NISSAN MICRA (K11E) (92-02)</b>									
	1.0 i 16V 1.0 i 16V 1.3 i 16V 1.4 i 16V 1.5 D	40 44 55 60 42		08.92 07.00 08.00 12.02 08.92 07.00 08.00 12.02 02.98 12.02		BA2232		21626 15,8	AKE
	1.0 i 16V 1.0 i 16V 1.3 i 16V 1.4 i 16V 1.5 D	40 44 55 60 42		08.92 07.00 - ABS 08.00 12.02 - ABS 08.92 07.00 - ABS 08.00 12.02 - ABS 02.98 12.02 - ABS		BAR12137		234 12,0 10,0	
	1.0 i 16V 1.0 i 16V 1.3 i 16V 1.4 i 16V 1.5 D	40 44 55 60 42		08.92 08.00 - ABS 09.00 12.02 - ABS 08.92 08.00 - ABS 09.00 12.02 - ABS 02.98 12.02		BAW1703		Rz 17,78	
<b>NISSAN MICRA (K12E) (03-)</b>									
	1.0 i 16V 1.2 i 16V 1.2 i 16V 1.4 i 16V 1.5 dCi 1.5 dCi 1.5 dCi 1.5 dCi 1.6 i 16V	48 48 59 65 48 50 60 63 81		01.03 01.03 01.03 01.03 01.03 09.03 01.03 05.05		BA2284		23973 17,3 /S	LUC
<b>NISSAN MICRA C+C (CK12E) (05-)</b>									
	1.4 i 16V 1.6 i 16V	65 81		08.05 08.05		BA2284		23973 17,3 /S	LUC
<b>NISSAN NOTE (E11E) (06-)</b>									
	1.4 1.5 dCi 1.5 dCi 1.5 dCi 1.5 dCi 1.6	65 50 63 66 76 81		03.06 03.06 03.06 09.10 07.08 03.06		BA2284		23973 17,3 /S	LUC
<b>NISSAN PICK-UP (D22) (98-07)</b>									
	2.4 i 4WD 2.5 TD 4WD	88 76		02.98 03.01 05.98 03.01		BAR26109		277 26,0 24,0 V	
<b>NISSAN PRIMASTAR (X83) Bus (01-)</b>									
	1.9 dCi (100) 1.9 dCi (80) 2.0 dCi (120) 2.0 dCi (90) 2.0 i 16V 2.5 dCi (140) 2.5 dCi (150)	74 60 84 66 88 99 107		03.01 08.06 03.01 08.06 09.06 09.06 03.01 07.03 08.06 09.06		BA2254		23099 18,4 /S	LUC
	1.9 dCi (100) 1.9 dCi (80) 2.0 dCi (120) 2.0 dCi (90) 2.0 i 16V 2.5 dCi (140) 2.5 dCi (150)	74 60 84 66 88 99 107		03.01 08.06 03.01 08.06 09.06 09.06 03.01 07.03 08.06 09.06		BAR28132		306 28,0 24,0 V L	
	1.9 dCi (100) 1.9 dCi (80) 2.0 dCi (120) 2.0 dCi (90) 2.0 i 16V 2.5 dCi (140) 2.5 dCi (150)	74 60 84 66 88 99 107		03.01 08.06 03.01 08.06 09.06 09.06 03.01 07.03 08.06 09.06		BA2247		23980 16,0 /WE/S	LUC
<b>NISSAN PRIMASTAR (X83) Van (02-)</b>									
	1.9 dCi (100) 1.9 dCi (80) 2.0 dCi (120) 2.0 dCi (90) 2.0 i 16V 2.5 dCi (140) 2.5 dCi (150)	74 60 84 66 88 99 107		07.02 08.06 07.02 08.06 09.06 09.06 07.02 07.03 08.06 09.06		BA2254		23099 18,4 /S	LUC
	1.9 dCi (100) 1.9 dCi (80) 2.0 dCi (120) 2.0 dCi (90) 2.0 i 16V 2.5 dCi (140) 2.5 dCi (150)	74 60 84 66 88 99 107		07.02 08.06 07.02 08.06 09.06 09.06 07.02 07.03 08.06 09.06		BAR28132		306 28,0 24,0 V L	

								
<b>NISSAN PRIMASTAR (X83) Van (02-)</b>								
	1.9 dCi (100)	74		07.02	08.06			
	1.9 dCi (80)	60		07.02	08.06			
	2.0 dCi (120)	84		09.06				
	2.0 dCi (90)	66		09.06				
	2.0 i 16V	88		07.02				
	2.5 dCi (140)	99		07.03	08.06			
	2.5 dCi (150)	107		09.06				
<b>NISSAN PRIMERA (P10E) Limousine (90-96)</b>								
	1.6			05.93	01.96 + ABS			
	1.6 i			05.93	01.96 + ABS			
	2.0 D			05.93	01.96			
	2.0 i 16V			06.90	01.96			
	2.0 i 16V 4x4			06.90	06.96			
	1.6			05.93	01.96 + ABS			
	1.6 i			05.93	01.96 + ABS			
	2.0 D			05.93	01.96			
	2.0 i 16V			06.90	01.96			
	2.0 i 16V 4x4			06.90	06.96			
<b>NISSAN PRIMERA (P11E) Limousine (96-02)</b>								
	1.6 i 16V			04.98	02.02			
	1.8 i 16V	84		06.99	02.02			
	2.0 i 16V	85		04.98	02.02			
	2.0 i 16V	96		04.98	02.02			
	2.0 i 16V	103		06.99	02.02			
	2.0 i 16V	110		06.96	02.02			
	2.0 TD	66		04.98	02.02			
	1.8 i 16V	84		06.99	02.02 + ABS			
	2.0 i 16V	85		06.96	02.02			
	2.0 i 16V	96		06.96	02.02			
	2.0 i 16V	103		06.99	02.02			
	2.0 i 16V	110		06.96	02.02			
	2.0 i 16V	85		06.96	05.99			
	2.0 i 16V	96		06.96	05.99			
	2.0 i 16V	103		06.99	02.02			
	2.0 i 16V	110		06.96	05.99			
<b>NISSAN PRIMERA (P12E) Limousine (02-08)</b>								
	1.6	78		03.02	10.08			
	1.6	80		03.02	04.06			
	1.8	85		03.02	10.08			
	1.9 dCi	88		04.03	10.07			
	2.0	103		03.02	10.08			
	2.2 dCi	102		04.03	10.07			
	2.2 Di	93		03.02	04.03			
	2.5	125		03.02	04.06			
	1.6	78		03.02	10.08			
	1.6	80		03.02	04.06			
	1.8	85		03.02	10.08			
	1.9 dCi	88		04.03	10.07			
	2.0	103		03.02	10.08			
	2.2 dCi	102		04.03	10.07			
	2.2 Di	93		03.02	04.03			
	2.5	125		03.02	04.06			
	1.6	78		03.02	10.08			
	1.6	80		03.02	04.06			
	1.8	85		03.02	10.08			
	1.9 dCi	88		04.03	10.07			
	2.0	103		03.02	10.08			
	2.2 dCi	102		04.03	10.07			
	2.2 Di	93		03.02	04.03			
	2.5	125		03.02	04.06			
	1.6	78		03.02	10.08			
	1.6	80		03.02	04.06			
	1.8	85		03.02	10.08			
	1.9 dCi	88		04.03	10.07			
	2.0	103		03.02	10.08			
	2.2 dCi	102		04.03	10.07			
	2.2 Di	93		03.02	04.03			
	2.5	125		03.02	04.06			
<b>NISSAN PRIMERA (W11) Kombi (98-02)</b>								
	1.6 i 16V	66		04.98	02.02			
	1.6 i 16V	73		04.98	02.02			
	1.8 i 16V	84		08.99	02.02			
	2.0 i 16V	85		04.98	06.99			
	2.0 i 16V	96		04.98	06.99			
	2.0 TD	66		04.98	02.02			
	1.6 i 16V	66		04.98	02.02			
	1.6 i 16V	73		04.98	02.02			
	1.8 i 16V	84		08.99	02.02			
	2.0 i 16V	85		04.98	02.02			
	2.0 i 16V	96		04.98	02.02			
	2.0 i 16V	103		08.99	02.02			
	2.0 TD	66		04.98	02.02			

								
<b>NISSAN PRIMERA (W11) Kombi (98-02)</b>								
	1.6 i 16V 1.6 i 16V 1.8 i 16V 2.0 i 16V 2.0 i 16V 2.0 i 16V 2.0 TD	66 73 84 85 96 103 66		04.01 04.01 04.01 04.01 04.01 04.01 04.01	02.02 02.02 02.02 02.02 02.02 02.02 02.02	BAR10215		258 10,0 9,0
<b>NISSAN PRIMERA (W12) Kombi (02-08)</b>								
	1.6 1.6 1.8 1.9 dCi 2.0 2.2 dCi 2.2 Di 2.5	78 80 85 88 103 102 93 125		03.02 03.02 03.02 04.03 03.02 04.03 03.02 03.02	10.08 04.06 10.08 10.07 10.08 10.07 04.03 04.06	BA2278		23094 16,5 +/-WK/S LUC
	1.6 1.6 1.8 1.9 dCi 2.0 2.2 dCi 2.2 Di 2.5	78 80 85 88 103 102 93 125		03.02 03.02 03.02 04.03 03.02 04.03 03.02 03.02	10.08 04.06 10.08 10.07 10.08 10.07 04.03 04.06	BAR28140		280 28,0 26,0 V
	1.6 1.6 1.8 1.9 dCi 2.0 2.2 dCi 2.2 Di 2.5	78 80 85 88 103 102 93 125		03.02 03.02 03.02 04.03 03.02 04.03 03.02 03.02	10.08 04.06 10.08 10.07 10.08 10.07 04.03 04.06	BA2238		23482 16,4 + ATE
	1.6 1.6 1.8 1.9 dCi 2.0 2.2 dCi 2.2 Di 2.5	78 80 85 88 103 102 93 125		03.02 03.02 03.02 04.03 03.02 04.03 03.02 03.02	10.08 04.06 10.08 10.07 10.08 10.07 04.03 04.06	BAR10285		278 10,0 9,0
<b>NISSAN SERENA/VANETTE CARGO (C23M/963) (92-01)</b>								
	1.6 i 16V 2.0 D 2.0 i 16V 2.3 D	71 49 93 55		07.92 07.92 07.92 09.94	11.01 + 2-Kolbensattel <sup>1)</sup> 08.94 + 2-Kolbensattel <sup>1)</sup> 11.01 11.01 + 2-Kolbensattel <sup>1)</sup>	BA2119		21481 15,5 LUC
	1.6 i 16V 2.0 D 2.0 i 16V 2.3 D	71 49 93 55		07.92 07.92 07.92 09.94	11.01 + 2-Kolbensattel <sup>1)</sup> 08.94 + 2-Kolbensattel <sup>1)</sup> 11.01 11.01 + 2-Kolbensattel <sup>1)</sup>	BAR26108		257 26,0 24,0 V
<b>NISSAN SUNNY (N14) Limousine (90-95)</b>								
	1.4 1.6 16V 1.6 16V 4x4 2.0 D			10.90 10.90 10.90 10.90	05.95 05.95 05.95 05.95	BA2113		21659 16,4 +/-WK SUM
	1.4 1.6 16V 1.6 16V 4x4 2.0 D			10.90 10.90 10.90 10.90	05.95 05.95 05.95 05.95	BAR18107		240 18,0 16,0 V
<b>NISSAN SUNNY (Y10) Kombi (90-00)</b>								
	1.6 16V 1.6 16V 4x4 1.7 D 2.0 D			11.90 11.90 11.90 11.90	03.00 03.00 03.00 03.00	BAR18107		240 18,0 16,0 V
<b>NISSAN TERRANO I (WD21) (87-97)</b>								
	2.4 i 4WD 2.7 TD 4WD 3.0 i V6 4WD	76 73 109		08.87 08.87 01.90	10.93 10.93 09.97	BAR26109		277 26,0 24,0 V
<b>NISSAN TERRANO II (R20) (93-06)</b>								
	2.4 i 4WD 2.4 i 4WD 2.7 TD 4WD 2.7 TDi 4WD 3.0 Di 4WD	87 91 74 92 113		05.96 02.93 02.93 05.96 05.02	11.05 04.96 01.02 11.05 04.06	BA2119		21481 15,5 LUC
	2.4 i 4WD 2.4 i 4WD 2.7 TD 4WD 2.7 TDi 4WD 3.0 Di 4WD	87 91 74 92 113		05.96 02.93 02.93 05.96 05.02	11.05 04.96 01.02 11.05 04.06	BAR26109		277 26,0 24,0 V

<sup>1)</sup> + 2 piston caliper / + pinza freno a 2 pistoni / + étrier à 2 pistons / + pinza de dos pistones

        										
<b>NISSAN TERRANO II (R20) (93-06)</b>										
	2.4 i 4WD 2.7 TD 4WD 2.7 TDi 4WD 2.7 TDi 4WD	87 74 92 92		10.99 10.99 10.99 10.99	01.02 01.02 01.02 01.02	+ ABS/ + 2 türig <sup>1)</sup> + ABS/ + 2 türig <sup>1)</sup> + ABS/ + Schaltgetriebe/ + 2 türig <sup>2)</sup> + Automatikgetriebe/ + 2 türig <sup>3)</sup>	BAW2010			Rz 20,64
<b>NISSAN X-TRAIL (T30) (01-07)</b>										
	2.0 i 16V 2.0 i 16V 4x4 2.2 dCi 2.2 dCi 4x4 2.2 TDi 4x4 2.5 i 16V 4x4	103 103 100 100 84 121		07.01 07.01 12.03 12.03 07.01 01.03	02.07 02.07 02.07 02.07 11.03 02.07		BAR28140			280 28,0 26,0 V
<b>OPEL AGILA (00-07)</b>										
	1.0 1.0 12V 1.2 16V 1.3 CDTI			08.03 09.00 09.00 08.03	07.07 07.07 07.07 07.07		BA2260			23253 15,9 +/WK/S <b>BOS</b>
<b>OPEL AGILA (08-)</b>										
	1.0 1.2 1.3 CDTI	48  55		01.08 01.08 01.08			BA2301			23973 17,3 +/WK/S <b>LUC</b>
<b>OPEL ARENA (97-01)</b>										
	1.9 D 2.5 D			03.98 03.98	09.01 09.01		BA2086			20926 18,5 /WK <b>BDX</b>
	1.9 D 2.5 D			03.98 03.98	09.01 09.01		BAR24103			252 24,0 22,0 V
<b>OPEL ASTRA F / Vauxhall Astra MKIII (91-01)</b>										
	1.4 Cabrio 1.4 N 1.4 S 1.6 Cabrio 1.6 N 1.6 Si 1.7 D 1.7 TD 1.8			10.91 10.91 10.91 10.91 10.91 03.92 10.91 10.91 10.91	03.01 09.98 09.98 03.01 09.98 12.94 09.98 09.98 09.98	- verstärkte Bremse <sup>4)</sup>	BA2136 BAV1027	2		20547 16,8 +/WE <b>ATE</b> Warnkontakt L=685mm
	1.4 S 1.6 1.6 16V 1.6 N Caravan 1.6 S 1.7 D 1.7 TD 1.8 16V 1.8 Cabrio 2.0 2.0 Cabrio 2.0 GSi 2.0 GSi 16V			10.91 10.91 02.93 10.91 10.91 10.91 10.91 10.91 10.91 10.91 10.91 10.91 10.91	09.98 09.98 09.98 09.98 09.98 09.98 09.98 09.98 03.01 09.98 09.98 09.98 09.98	+ verstärkte Bremse <sup>5)</sup>	BA2137 BAV1028	2		21190 17,5 +/WE <b>ATE</b> Warnkontakt L=680mm
	1.4 N 1.4 S 1.6 N Limousine		T5000073	10.91 10.91 10.91	09.98 09.98 09.98	- verstärkte Br./+ Schaltgetr. <sup>6)</sup> + Schaltgetriebe <sup>7)</sup>	BAR13161			236 12,7 10,7
	1.4 Cabrio 1.4 S 1.6 Cabrio 1.6 N Caravan 1.6 N Limousine 1.6 N Limousine 1.6 S 1.6 Si 1.7 D 1.7 TD		T5000074	10.91 10.91 10.91 10.91 10.91 10.91 03.92 10.91 10.91 10.91	03.01 09.98 03.01 09.98 09.98 09.98 12.94 09.98 09.98 09.98	+ verstärkte Br./+ Automatikg. <sup>8)</sup>	BAR20115			236 20,0 17,0 V L
	1.4 S 1.6 1.6 16V 1.7 D 1.7 TD 1.8 16V 1.8 Cabrio 2.0 2.0 Cabrio 2.0 GSi 2.0 GSi 16V			10.91 10.91 02.93 10.91 10.91 10.91 10.91 10.91 10.91 10.91 10.91	09.98 09.98 09.98 09.98 09.98 09.98 09.98 09.98 03.01 09.98 09.98 09.98	+ verstärkte Bremse <sup>5)</sup>	BAR24115			256 24,0 21,0 V L
	1.8 16V 2.0 GSi 2.0 GSi 16V			10.91 10.91 10.91	09.98 09.98 09.98		BA2098			21140 15,7 <b>ATE</b>

<sup>1)</sup> + ABS/ + 2 door / + ABS/ + 2 porte / + ABS/ + 2 portes / + ABS/ + 2 puertas

<sup>2)</sup> + ABS/ + manual transm./ + 2 door / + ABS/ + scatola camb.velocità/ + 2 porte / + ABS/ + transmiss.mécanique/ + 2 portes / + ABS/ + cambio velocidad/ + 2 puertas

<sup>3)</sup> + autom.transm./ + 2 door / + scatola camb.autom./ + 2 porte / + transmission automatique/ + 2 portes / + cambio automático/ + 2 puertas

<sup>4)</sup> - heavy duty brake / - freno rinforzato / - frein renforcé / - freno reforzado

<sup>5)</sup> + heavy duty brake / + freno rinforzato / + frein renforcé / + freno reforzado





<sup>6)</sup> - heavy duty br./ + manual trans. / - fr.rinforzato/+ scatola camb.velocità / - frein renforcé/ + transm.mécanique / - freno reforzado/ + camb.velocidad

<sup>7)</sup> + manual transmission / + scatola cambio velocità / + transmission mécanique / + cambio de velocidad

<sup>8)</sup> - heavy duty br./ + autom.trans. / - fr.rinforzato/+ scatola cambio autom. / - frein renforcé/ + transm.automatique / - freno reforzado/ + camb.automático

<sup>9)</sup> + autom.transmission / + scatola cambio automatico / + transmission automatique / + cambio automático



OPEL ASTRA F / Vauxhall Astra MKIII (91-01)									
	1.8 16V 2.0 GSi 2.0 GSi 16V			10.91 10.91 10.91	09.98 09.98 09.98	BAR10204			260 10,0 8,0
	1.4 Cabrio 1.4 N Limousine 1.4 S Limousine 1.6 1.6 16V Limousine 1.6 Cabrio 1.6 Limousine 1.7 D Limousine 1.7 TD Limousine 1.8 Cabrio 1.8 Limousine 2.0 Cabrio 2.0 Limousine	52 66 85	R2500000 R2500000 R2500000 R2500000 R2500000 R2500000 R2500000 R2500000 R2500000 R2500000 R2500000 R2500000 R2500000	10.91 10.91 10.91 05.93 02.93 10.91 10.91 10.91 10.91 10.91 10.91 10.91 10.91		BAW1705	- verstärkte Bremse <sup>1)</sup>		Rz 17,46 LUC
	1.4 Cabrio 1.4 Caravan 1.4 N Limousine 1.4 S Limousine 1.4 S Limousine 1.6 1.6 16V Limousine 1.6 Cabrio 1.6 Caravan 1.6 Limousine 1.7 D Caravan 1.7 D Limousine 1.7 TD Caravan 1.7 TD Limousine 1.8 16V Cabrio 1.8 16V Caravan 1.8 16V Limousine 1.8 Cabrio 1.8 Caravan 1.8 Limousine 2.0 Cabrio 2.0 Caravan 2.0 Limousine	R2500001 R2500001 R2500001 52 R2500001 R2500001 R2500001 R2500001 R2500001 R2500001 85 85 85 R2500001 66 R2500001 R2500001 85 R2500001		10.91 10.91	03.01 09.98 09.98 09.98 09.98 07.96 09.98 03.01 09.98 09.98 09.98 09.98 09.98 11.94 07.94 11.94 03.01 09.98 09.98 09.98 10.94 09.98 09.98	BAW1904	+ GG <sup>2)</sup>	Rz 19,05 LUC	
	1.4 N Limousine 1.4 S Limousine 1.6 N Limousine 1.7 D Limousine		SP999999 SP999999 SP999999 SP999999	10.91 10.91 10.91 10.91		BAE5005	+ Schaltgetriebe <sup>4)</sup> + Schaltgetriebe <sup>4)</sup> + Schaltgetriebe <sup>4)</sup>	200 x 29 HEB	
	1.4 Cabrio 1.4 Caravan 1.4 N Limousine 1.4 S Limousine 1.4 S Limousine 1.6 16V Limousine 1.6 Cabrio 1.6 Caravan 1.6 N Limousine 1.6 S Limousine 1.7 D Caravan 1.7 D Limousine 1.7 TD Caravan 1.7 TD Limousine 1.8 16V Cabrio 1.8 16V Caravan 1.8 16V Limousine 1.8 Cabrio 1.8 Caravan 1.8 Limousine 2.0 Cabrio 2.0 Caravan 2.0 Limousine	T2500001 T2500001	SP999999 SP999999	10.91 10.91 10.91 10.91 10.91 02.93 10.91 10.91 10.91 10.91 10.91 10.91 10.91 10.91 11.94 07.94 11.94 10.91 10.91 10.91 10.91 10.91 10.91	03.01 09.98 09.98 09.98 09.98 09.98 03.01 09.98 09.98 09.98 09.98 09.98 09.98 09.98 03.01 03.01 09.98 09.98 09.98 09.98 10.94 10.94 09.98	BAE5011	+ Automatikgetriebe <sup>5)</sup> + Schaltgetriebe <sup>4)</sup> + Automatikgetriebe <sup>5)</sup> + Schaltgetriebe <sup>4)</sup> + Automatikgetriebe <sup>5)</sup> + Schaltgetriebe <sup>4)</sup>	200 x 46 HEB	
	1.4 Caravan 1.6 Caravan 1.7 D Caravan 1.7 TD Caravan 1.8 16V Caravan 1.8 Caravan 2.0 Caravan	T2500001 T2500001 T2500001 T2500001 85 T2500001 T2500001 T2500001		09.98 09.98 09.98 09.98 01.98 09.98 09.98		BAE5012		230 x 42	
OPEL ASTRA G / Vauxhall Astra MKIV (98-04)									
	1.2 16V 1.4 16V 1.6 1.6 16V 1.6 16V Cabrio 1.7 CDTI 1.7 DTI 1.7 TD 1.8 16V 1.8 16V Cabrio			04.98 04.98 04.98 04.98 03.01 04.03 02.00 04.98 04.98 03.01	12.04 12.04 12.04 12.04 12.04 12.04 12.04 08.00 12.04 12.04	BA2173 BAV1014	2 bis Fgst.Nr.: 42187758 <sup>6)</sup>	23063 17,3 +/-WK Warnkontakt L=740mm	ATE

<sup>1)</sup> - heavy duty brake / - freno rinforzato / - frein renforcé / - freno reforzado

<sup>2)</sup> + cast iron / + ghisa / + fonte grise / + fundición de gris

<sup>3)</sup> + heavy duty brake / + freno rinforzato / + frein renforcé / + freno reforzado

<sup>4)</sup> + manual transmission / + scatola cambio velocità / + transmission mécanique / + cambio de velocidad

<sup>5)</sup> + autom.transmission / + scatola cambio automatico / + transmission automatique / + cambio automático

<sup>6)</sup> up to chassis: ... / fino no.telaiio: ... / jusqu'au de chassis: ... / hasta no.de chasis: ...

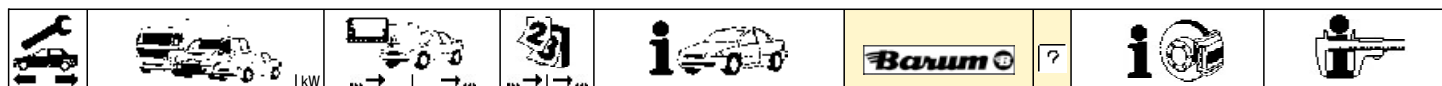

**OPEL ASTRA G / Vauxhall Astra MKIV (98-04)**

	1.8 16V Caravan			04.98	12.04 - ABS	BA2173	2	bis Fgst.Nr.: 42187758	23063 17,3 +/-WK Warnkontakt L=740mm	ATE	
	2.0 DI			04.98	12.04 - ABS	BAV1014					
	1.6 CNG			03.03	12.04	BA2211	2	bis Fgst.Nr.: 42187758	23057 19,6 +/-WE Warnkontakt L=740mm	ATE	
	1.8 16V			04.98	12.04 + ABS	BAV1014					
	1.8 16V Cabrio			03.01	12.04 + ABS						
	1.8 16V Caravan			04.98	12.04 + ABS						
	1.8 16V Coupe			03.00	12.04						
	2.0 16V			04.98	12.04						
	2.0 DI			04.98	12.04 + ABS						
	2.0 DTI 16V			08.99	12.04						
	2.2 16V			09.00	12.04						
	2.2 16V Cabrio			03.01	12.04						
	2.2 16V Coupe			09.00	12.04						
	2.2 DTI 16V			09.02	12.04						
	2.2 DTI 16V Cabrio			09.02	12.04						
2.2 DTI 16V Coupe			09.02	12.04							
2.0 16V OPC			10.99	12.04	BAV1014	2	bis Fgst.Nr.: 42187758	Warnkontakt L=740mm			
2.0 16V OPC Cabrio			03.02	12.04							
2.0 Turbo			03.00	12.04							
	1.2 16V	22000001	18999999	04.98	12.04 + HA-Scheibenbremse 1)	BAR24152		für 4-Loch-Felge 2)	256 24,0 21,0 V L		
	1.2 16V				12.04						
	1.4 16V			04.98	12.04						
	1.6			04.98	12.04						
	1.6 16V			04.98	12.04						
	1.6 16V Cabrio			03.01	12.04						
	1.7 CDTI			04.03	12.04						
	1.7 DTI			02.00	12.04						
	1.7 TD			04.98	08.00						
	1.8 16V			04.98	12.04 - ABS						
	1.8 16V Cabrio			03.01	12.04 - ABS						
	1.8 16V Caravan			04.98	12.04 - ABS						
	2.0 DI			04.98	12.04 - ABS						
	1.6			04.98	12.04	BAR25131		für 5-Loch-Felge 3)	280 25,0 22,0 V L		
	1.6 16V			04.98	12.04						
	1.6 CNG			03.03	07.04						
	1.8 16V			04.98	12.04 + ABS						
	1.8 16V Cabrio			03.01	12.04 + ABS						
	1.8 16V Caravan			04.98	12.04 + ABS						
	1.8 16V Coupe			03.00	12.04						
	2.0 16V			04.98	12.04						
	2.0 DI			04.98	12.04 + ABS						
	2.0 DTI 16V			08.99	12.04						
	2.2 16V			09.00	12.04						
	2.2 16V Cabrio			03.01	12.04						
	2.2 16V Coupe			09.00	12.04						
	2.2 DTI 16V			09.02	12.04						
	2.2 DTI 16V Cabrio			09.02	12.04						
	2.2 DTI 16V Coupe			09.02	12.04						
	2.0 16V OPC			10.99	12.04	BAR25142			308 25,0 22,0 V L		
	2.0 16V OPC Cabrio			03.02	12.04						
	2.0 Turbo			03.00	12.04						
		1.2 16V			04.98	12.04	BA2197			23258 16,9 +/-WK/Zub 23417 15,2 +/-WK/S	BOS LUC
		1.4 16V			04.98	12.04	BA2194				
		1.6			04.98	12.04					
1.6 16V				04.98	12.04						
1.6 16V Cabrio				03.01	12.04						
1.6 16V Caravan				04.98	12.04						
1.6 CNG				03.03	07.04						
1.7 CDTI				04.03	12.04						
1.7 DTI				02.00	12.04						
1.7 TD				04.98	08.00						
1.8 16V				04.98	12.04						
1.8 16V Cabrio				03.01	12.04						
1.8 16V Coupe				03.00	12.04						
2.0 16V				04.98	12.04						
2.0 16V OPC				10.99	12.04						
2.0 16V OPC Cabrio				03.02	12.04						
2.0 DI				04.98	12.04						
2.0 DTI 16V				08.99	12.04						
2.0 Turbo				03.00	12.04						
2.2 16V				09.00	12.04						
2.2 16V Cabrio				03.01	12.04						
2.2 16V Coupe				09.00	12.04						
2.2 DTI 16V				09.02	12.04						
2.2 DTI 16V Cabrio				09.02	12.04						
2.2 DTI 16V Coupe				09.02	12.04						
	1.2 16V			04.98	12.04	BAR10251		für 4-Loch-Felge 2)	240 9,9 8,0		
	1.4 16V			04.98	12.04						
	1.6			04.98	12.04						
	1.6 16V			04.98	12.04						
	1.6 16V Cabrio			03.01	12.04						
	1.7 CDTI			04.03	12.04						
	1.7 DTI			02.00	12.04						
	1.7 TD			04.98	08.00						
	1.8 16V			04.98	12.04 - ABS						
	1.8 16V Cabrio			03.01	12.04 - ABS						

1) + RA disc brake / + P disco freno / + frein à disque essieu AR / + ET-disco de freno

2) for 4 bore wheel rim / per cerchione a 4 fori / pour jante à 4 trous / para Llanteras de 4 taladros

3) for 5 bore wheel rim / per cerchione a 5 fori / pour jante à 5 trous / para Llanteras de 5 taladros

4) up to chassis: 42187758 / fino no.telai: 42187758 / jusqu'au de chassis: 42187758 / hasta no.de chasis: 42187758

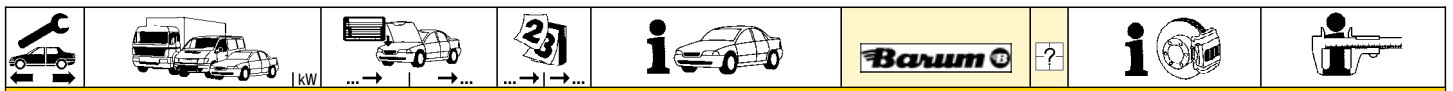













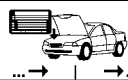



**OPEL ASTRA G / Vauxhall Astra MKIV (98-04)**

	1.8 16V Caravan		04.98	12.04	- ABS	BAR10251	für 4-Loch-Felge <sup>1)</sup>	240 9,9 8,0
	2.0 DI		04.98	12.04	- ABS			
	1.6 16V		04.98	12.04		BAR10250	für 5-Loch-Felge <sup>2)</sup>	264 9,9 8,0
	1.6 CNG		03.03	07.04				
	1.8 16V		04.98	12.04	+ ABS			
	1.8 16V Cabrio		03.01	12.04	+ ABS			
	1.8 16V Caravan		04.98	12.04	+ ABS			
	1.8 16V Coupe		03.00	12.04				
	2.0 16V		04.98	12.04				
	2.0 16V OPC		10.99	12.04				
	2.0 16V OPC Cabrio		03.02	12.04				
	2.0 DI		04.98	12.04	+ ABS			
	2.0 DTI 16V		08.99	12.04				
	2.0 Turbo		03.00	12.04				
	2.2 16V		09.00	12.04				
2.2 16V Cabrio		03.01	12.04					
2.2 16V Coupe		09.00	12.04					
2.2 DTI 16V		09.02	12.04					
2.2 DTI 16V Cabrio		09.02	12.04					
2.2 DTI 16V Coupe		09.02	12.04					
	1.2 16V Limousine		04.98	12.04		BAE5011		200 x 46 HEB
	1.2 16V Caravan		18999999	04.98		BAE5012		230 x 42
	1.4 16V		18999999	04.98				
	1.6		18999999	04.98				
	1.6 16V		18999999	04.98				
	1.6 CNG		18999999	03.03				
	1.7 DTI		18999999	02.00				
	1.7 TD		04.98	08.00				
	1.2 16V Caravan	22000001		12.04		BAE5033		230 x 42 HEB
	1.4 16V	22000001		12.04				
1.6	22000001		12.04					
1.6 16V	22000001		12.04					
1.6 CNG	22000001		07.04					
1.7 DTI	22000001		12.04					

**OPEL ASTRA H / GTC / Vauxhall Astra MKV (04-10)**























	1.2		08.05	11.10		BA2255		23832 19,7 +/-WK	ATE
	1.3 CDTI	66	08.05	11.10					
	1.4		01.04	11.10					
	1.6	77	01.04	11.10					
	1.6	85	01.07	11.10					
	1.6 Turbo	132	01.07	11.10					
	1.7 CDTI	59	01.04	11.10					
	1.7 CDTI	74	01.04	11.10					
	1.7 CDTI	81	04.07	11.10					
	1.7 CDTI	92	04.07	11.10					
	1.8	92	01.04	11.10					
	1.8	103	01.06	11.10					
	1.9 CDTI	74	09.05	11.10					
	1.9 CDTI	88	09.04	11.10					
	1.9 CDTI	110	09.04	11.10					
2.0 Turbo	125	01.04	11.10						
2.0 Turbo OPC	177	03.05	11.10		BA2236	für Bremssattel mit Kunststoffkolben <sup>3)</sup>	23402 20,4 +/-WE	ATE	
	1.2		08.05	11.10		BAR25131	für 5-Loch-Felge <sup>2)</sup>	280 25,0 22,0 V L	
	1.3 CDTI	66	08.05	11.10					
	1.4		01.04	11.10					
	1.6	77	01.04	11.10					
	1.6	85	01.07	11.10					
	1.7 CDTI	59	01.04	11.10					
	1.7 CDTI	74	01.04	11.10					
	1.7 CDTI	81	04.07	11.10					
	1.8	92	01.04	11.10					
	1.8	103	01.06	11.10					
	1.6 Turbo	132	01.07	11.10		BAR25142	für 5-Loch-Felge <sup>2)</sup>	308 25,0 22,0 V L	
	1.7 CDTI	92	04.07	11.10					
	1.9 CDTI	74	09.05	11.10					
	1.9 CDTI	88	09.04	11.10					
	1.9 CDTI	110	09.04	11.10					
	2.0 Turbo	125	01.04	11.10					
	2.0 Turbo	147	09.04	11.10					
	1.2		08.05	11.10		BA2194		23417 15,2 +/-WK/S	LUC
	1.3 CDTI	66	08.05	11.10					
	1.4		01.04	11.10					
	1.6	77	01.04	11.10					
	1.6	85	01.07	11.10					
	1.6 Turbo	132	01.07	11.10					
	1.7 CDTI	59	01.04	11.10					
	1.7 CDTI	74	01.04	11.10					
	1.7 CDTI	81	04.07	11.10					
	1.7 CDTI	92	04.07	11.10					
	1.8	92	01.04	11.10					
	1.8	103	01.06	11.10					
	1.9 CDTI	74	09.05	11.10					
	1.9 CDTI	88	09.04	11.10					
	1.9 CDTI	110	09.04	11.10					

1) for 4 bore wheel rim / per cerchione a 4 fori / pour jante à 4 trous / para Llantas de 4 taladros  
 2) for 5 bore wheel rim / per cerchione a 5 fori / pour jante à 5 trous / para Llantas de 5 taladros  
 3) + for br.caliper +plastic piston / per pinza fr. +pistone plastica / pour étrier fr. +piston plastique / para pinza fr. + pistón plástico

								
<b>OPEL ASTRA H / GTC / Vauxhall Astra MKV (04-10)</b>								
	2.0 Turbo 2.0 Turbo 2.0 Turbo OPC	125 147 177		01.04 09.04 03.05	11.10 11.10 11.10	BA2194		23417 15,2 +WK/S LUC
	1.2 1.3 CDTI 1.4 1.6 1.6 1.6 Turbo 1.7 CDTI 1.7 CDTI 1.7 CDTI 1.7 CDTI 1.8 1.8 1.9 CDTI 1.9 CDTI 1.9 CDTI 2.0 Turbo 2.0 Turbo	66 77 85 132 59 74 81 92 92 103 74 88 110 125 147		08.05 08.05 01.04 01.04 01.07 01.07 01.04 01.04 04.07 04.07 01.04 01.06 09.05 09.04 09.04 01.04 09.04	11.10 11.10 11.10 11.10 11.10 11.10 11.10 11.10 11.10 11.10 11.10 11.10 11.10 11.10 11.10 11.10 11.10	BAR10251 BAR10250	für 4-Loch-Felge <sup>1)</sup> für 5-Loch-Felge <sup>2)</sup>	240 9,9 8,0 264 9,9 8,0
	1.2 1.4 1.6 1.7 CDTI 1.7 CDTI	77 59 74		08.05 01.04 01.04 01.04 01.04	11.10 11.10 11.10 11.10 11.10	BAE5033		230 x 42 HEB
<b>OPEL ASTRA H Caravan/Vau. Astra MKV Estate (04-10)</b>								
	1.3 CDTI 1.4 1.6 1.6 1.6 LPG 1.6 Turbo 1.7 CDTI 1.7 CDTI 1.7 CDTI 1.7 CDTI 1.8 1.8 1.9 CDTI 1.9 CDTI 1.9 CDTI 2.0 Turbo 2.0 Turbo	66 77 85 85 132 59 74 81 92 92 103 74 88 110 125 147		08.05 08.04 08.04 01.07 08.09 01.07 08.04 08.04 04.07 04.07 09.04 08.05 09.05 08.04 09.04 08.04 09.04	11.10 11.10 11.10 11.10 11.10 11.10 11.10 11.10 11.10 11.10 11.10 11.10 11.10 11.10 11.10 11.10 11.10	BA2255		23832 19,7 +WK ATE
	1.8 1.3 CDTI 1.4 1.6 1.6 1.6 LPG 1.7 CDTI 1.7 CDTI 1.7 CDTI 1.8 1.6 Turbo 1.7 CDTI 1.9 CDTI 1.9 CDTI 1.9 CDTI 2.0 Turbo 2.0 Turbo	92 66 77 85 85 59 74 81 103 132 92 74 88 110 125 147		09.04 08.05 08.04 08.04 01.07 08.09 08.04 08.04 04.07 08.05 01.07 04.07 09.05 08.04 09.04 08.04 09.04	11.10 11.10 11.10 11.10 11.10 11.10 11.10 11.10 11.10 11.10 11.10 11.10 11.10 11.10 11.10 11.10 11.10	BAR25131 BAR25131 BAR25142	für 5-Loch-Felge <sup>2)</sup> für 5-Loch-Felge <sup>2)</sup> für 5-Loch-Felge <sup>2)</sup>	280 25,0 22,0 V L 280 25,0 22,0 V L 308 25,0 22,0 V L
	1.3 CDTI 1.4 1.6 1.6 1.6 LPG 1.6 Turbo 1.7 CDTI 1.7 CDTI 1.7 CDTI 1.7 CDTI 1.8 1.8 1.9 CDTI 1.9 CDTI 1.9 CDTI 2.0 Turbo 2.0 Turbo	66 77 85 85 132 59 74 81 92 92 103 74 88 110 125 147		08.05 08.04 08.04 01.07 08.09 01.07 08.04 08.04 04.07 04.07 09.04 08.05 09.05 08.04 09.04 08.04 09.04	11.10 11.10 11.10 11.10 11.10 11.10 11.10 11.10 11.10 11.10 11.10 11.10 11.10 11.10 11.10 11.10 11.10	BA2194		23417 15,2 +WK/S LUC
	1.3 CDTI 1.4 1.6 1.6 1.6 LPG 1.6 Turbo 1.7 CDTI 1.7 CDTI	66 77 85 85 132 59 74		08.05 08.04 08.04 01.07 08.09 01.07 08.04 08.04	11.10 11.10 11.10 11.10 11.10 11.10 11.10 11.10	BAR10251 BAR10250	für 4-Loch-Felge <sup>1)</sup> für 5-Loch-Felge <sup>2)</sup>	240 9,9 8,0 264 9,9 8,0
								

<sup>1)</sup> for 4 bore wheel rim / per cerchione a 4 fori / pour jante à 4 trous / para Llantas de 4 taladros

<sup>2)</sup> for 5 bore wheel rim / per cerchione a 5 fori / pour jante à 5 trous / para Llantas de 5 taladros

									
<b>OPEL ASTRA H Caravan/Vau. Astra MKV Estate (04-10)</b>									
	1.7 CDTI 1.7 CDTI 1.8 1.8 1.9 CDTI 1.9 CDTI 1.9 CDTI 2.0 Turbo 2.0 Turbo	81 92 92 103 74 88 110 125 147		04.07 04.07 09.04 08.05 09.05 08.04 09.04 08.04 09.04	11.10 11.10 11.10 11.10 11.10 11.10 11.10 11.10 11.10	BAR10251 BAR10250		für 4-Loch-Felge <sup>1)</sup> für 5-Loch-Felge <sup>2)</sup>	240 9,9 8,0 264 9,9 8,0
	1.4 1.6 1.7 CDTI 1.7 CDTI	 77 59 74		08.04 08.04 08.04 08.04	11.10 11.10 11.10 11.10	BAE5033			230 x 42 HEB
<b>OPEL ASTRA H TwinTop (06-)</b>									
	1.6 1.6 1.6 Turbo 1.8 1.9 CDTI 2.0 Turbo 2.0 Turbo	77 85 132  110 125 147		03.06 12.06 02.07 03.06 03.06 03.06 03.06		BA2255			23832 19,7 +WK ATE
	1.6 1.6 1.8	77 85		03.06 12.06 03.06		BAR25131		für 5-Loch-Felge <sup>2)</sup>	280 25,0 22,0 V L
	1.6 Turbo 1.9 CDTI 2.0 Turbo 2.0 Turbo	132 110 125 147		02.07 03.06 03.06 03.06		BAR25142		für 5-Loch-Felge <sup>2)</sup>	308 25,0 22,0 V L
	1.6 1.6 1.6 Turbo 1.8 1.9 CDTI 2.0 Turbo 2.0 Turbo	77 85 132  110 125 147		03.06 12.06 02.07 03.06 03.06 03.06 03.06		BA2194			23417 15,2 +WK/S LUC
	1.6 1.6 1.6 Turbo 1.8 1.9 CDTI 2.0 Turbo 2.0 Turbo	77 85 132  110 125 147		03.06 12.06 02.07 03.06 03.06 03.06 03.06		BAR10250		für 5-Loch-Felge <sup>2)</sup>	264 9,9 8,0
<b>OPEL CALIBRA / Vauxhall Calibra (89-97)</b>									
	2.0 2.0 16V 2.0 Turbo 2.5			09.89 09.89 03.92 02.93	07.97 07.97	BA2137 BAV1028	2		21190 17,5 +WE ATE Warnkontakt L=660mm
	2.0 Turbo 2.5	T1000001 T1000001			07.97 07.97	BA2207			21829 20,3 +WE ATE
	2.0 2.0 16V 2.0 Turbo 2.5			09.89 09.89 07.97 07.97	07.97 07.97	BAR24115 BAR25119			256 24,0 21,0 V L 288 25,0 22,0 V L
	2.0 2.0 16V 2.0 Turbo 2.5			09.89 09.89 03.92 02.93	07.97 07.97	BA2098			21140 15,7 ATE
	2.5	T1000001			07.97	BA2095			21050 15,7 ATE
	2.0 2.0 16V			09.89 09.89	07.97 07.97	BAR10205			270 9,9 8,0
<b>OPEL CAMPO (91-96)</b>									
	2.2 D 2.3 2.5 D 2.5 TD 3.1 TD			01.92 01.92 01.92 07.94 01.92	08.96 08.96 08.96 08.96 08.96	BA2114			21544 16,5 +WK AKE
<b>OPEL CAMPO (97-01)</b>									
	2.5 DTI 2.5 DTI 4x4 3.1 TD 3.1 TD 4x4			09.96 09.96 09.96 09.96	05.01 05.01 05.01 05.01	BA2114			21544 16,5 +WK AKE
<b>OPEL COMBO / Vauxhall Combo (01-)</b>									
	1.3 CDTI 1.4 16V 1.6 1.7 DI 16V 1.7 DTI 16V			06.03 10.01 10.01 10.01 10.01		BA2210			23225 17,0 +WK/S LUC
	1.3 CDTI 1.4 16V	53000001 53000001				BA2255			23832 19,7 +WK ATE

<sup>1)</sup> for 4 bore wheel rim / per cerchione a 4 fori / pour jante à 4 trous / para Llantas de 4 taladros

<sup>2)</sup> for 5 bore wheel rim / per cerchione a 5 fori / pour jante à 5 trous / para Llantas de 5 taladros

<b>OPEL COMBO / Vauxhall Combo (01-)</b>								
	1.6 1.6 CNG 1.7 CDTI 16V 1.7 DI 16V 1.7 DTI 16V	53000001  53000001 53000001		04.05 06.04		BA2255		23832 19,7 +/WK ATE
	1.3 CDTI 1.4 16V 1.6 1.7 DI 16V 1.7 DTI 16V		43033898 43033898 43033898 43033898 43033898	06.03 10.01 10.01 10.01 10.01		BAR24166		260 24,0 21,0 V L
	1.3 CDTI 1.4 16V 1.6 1.6 CNG 1.7 DI 16V 1.7 DTI 16V	43033899 43033899 43033899  43033899 43033899		04.05		BAR25148		280 25,0 22,0 V L
	1.7 CDTI 16V			06.04		BAR25131		280 25,0 22,0 V L
	1.6 CNG 1.7 CDTI 16V			04.05 06.04		BA2194		23417 15,2 +/WK/S LUC
	1.7 CDTI 16V			06.04		BAR10250		264 9,9 8,0
	1.3 CDTI 1.4 16V 1.6 1.7 DI 16V 1.7 DTI 16V			06.03 10.01 10.01 10.01 10.01		BAE5033		230 x 42 HEB
<b>OPEL CORSA B / Vauxhall Corsa (93-00)</b>								
	1.0 12V 1.2 1.2 16V 1.4 1.4 i 16V 1.4 Si 1.5 D 1.5 TD 1.6 GSI 16V 1.6 i 16V 1.7 D Combo	60    109		11.96 09.00 03.93 09.00 04.98 09.00 03.93 09.00 03.93 09.00 03.93 09.00 03.93 09.00 09.93 09.00 09.93 09.00 09.93 09.00 09.93 09.00		BA2136		20547 16,8 +/WE ATE
	1.0 12V 1.2 1.2 16V 1.2 16V 1.4 1.4 1.5 D 1.5 TD 1.7 D			11.96 09.00 03.93 09.00 04.98 09.00 04.98 09.00 03.93 09.00 03.93 09.00 03.93 09.00 03.93 09.00 09.93 09.00		BAR13161		236 12,7 10,7
	1.2 16V 1.2 16V 1.4 1.4 1.4 i 16V 1.4 Si Combo	60		04.98 09.00 04.98 09.00 03.93 09.00 03.93 09.00 09.93 09.00 03.93 09.00 09.93 09.00		BAR20115		236 20,0 17,0 V L
	1.0 12V 1.2 1.2 16V 1.4 1.4 i 16V 1.4 Si 1.5 D 1.5 TD 1.6 GSI 16V 1.6 i 16V 1.7 D	60   109		11.96 09.00 03.93 09.00 04.98 09.00 03.93 09.00 03.93 09.00 03.93 09.00 03.93 09.00 03.93 09.00 09.93 09.00 09.93 09.00 09.93 09.00		BAW1904	+ GG <sup>4)</sup>	Rz 19,05 LUC
	1.0 12V 1.2 1.2 16V 1.4 1.4 i 16V 1.4 Si 1.5 D 1.5 TD 1.6 GSI 16V 1.6 i 16V 1.7 D	60   109		11.96 09.00 03.93 09.00 04.98 09.00 03.93 09.00 03.93 09.00 03.93 09.00 03.93 09.00 03.93 09.00 09.93 09.00 09.93 09.00 09.93 09.00		BAE5005		200 x 29 HEB

1) - Sport/ + manual transm. / - Sport/ + cambio velocità / - Sport/ + transm. mécanique / - Sport/ + cambio velocidad  
2) - Sport/+ auto.transm./- air condit. / - Sport/+ scatola.auto./- aria condiz. / - Sport/+ transm.auto./- air condit. / - Sport/+ cambio auto./- aire acond.  
3) - Sport/+ auto.transm./+ air condit. / - Sport/+ scatola.auto./+ aria condiz. / - Sport/+ transm.auto./+ air condit. / - Sport/+ cambio auto./+ aire acond.  
4) + cast iron / + ghisa / + fonte grise / + fundición de gris

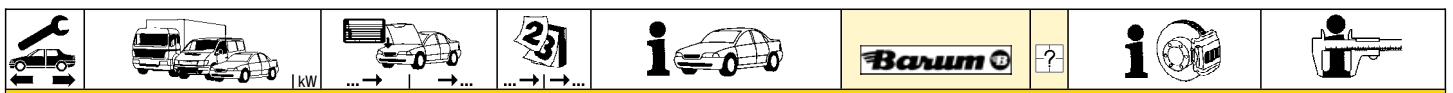

### OPEL CORSA C / Vauxhall Corsa MK II (00-06)

	1.0 12V		09.00	09.06	BA2210		23225 17,0 +/WK/S	LUC				
	1.2 16V		09.00	09.06								
	1.3 CDTI		06.03	09.06	BA2255		23832 19,7 +/WK	ATE				
	1.4 16V		09.00	09.06								
	1.6		09.01	09.06								
	1.7 DI 16V		09.00	09.06								
	1.7 DTI 16V		09.00	09.06								
	1.8 16V		09.00	09.06								
	1.7 CDTI		06.03	09.06								
	1.0 12V		09.00	09.06					BAR11152		240 10,9 8,0	
	1.2 16V		09.00	09.06								
		1.0 12V		09.00					09.06	BAR20174		240 19,9 17,0 V
1.2 16V			09.00	09.06								
1.7 DI 16V			09.00	09.06								
1.3 CDTI			06.03	09.06								
1.4 16V			09.00	09.06								
1.6			09.01	09.06								
1.7 DTI 16V			09.00	09.06								
1.8 16V		09.00	09.06	BAR24166		260 24,0 21,0 V L						
1.7 CDTI		06.03	09.06									
	1.0 12V		09.00	09.06	BAE5025		200 x 46 HEB					
	1.2 16V		09.00	09.06								
	1.3 CDTI		06.03	09.06								
	1.4 16V		09.00	09.06								
	1.6		09.01	09.06								
	1.7 CDTI		06.03	09.06								
	1.7 DI 16V		09.00	09.06								
	1.7 DTI 16V		09.00	09.06								

### OPEL CORSA D / Vauxhall Corsa MK III (06-)

	1.0 i		10.06		BA2256		23982 17,8 +/WK/S	BOS
	1.2	51	06.10					
	1.2	63	06.10					
	1.2 i 16V	59	10.06					
	1.2 LPG		09.09					
	1.3 CDTI	55	10.06	+ Bremsscheibe 257mm <sup>1)</sup>				
	1.3 CDTi	70	06.10	+ Bremsscheibe 257mm <sup>1)</sup>				
	1.4	64	09.09					
	1.4	74	06.10					
	1.4 i 16V	66	10.06					
	1.6 Turbo GSI	110	06.07		BA2255		23832 19,7 +/WK	ATE
	1.6 Turbo OPC		03.07					
	1.0 i		10.06		BAR12184		257 12,0 10,0	
	1.6 Turbo GSI	110	06.07					
	1.6 Turbo OPC		03.07		BAR25142		308 25,0 22,0 V L	

### OPEL FRONTERA A (92-98)

	2.0		SV720102	03.92	BA2114		21544 16,5 +/WK	AKE
	2.2 16V		SV720102	03.95				
	2.3 TD		SV720102	03.92				
	2.4		SV720102	03.92				
	2.5 TDS		SV720102	09.96				
	2.8 TD		SV720102	03.95				

### OPEL GT (07-09)

	2.0	194	02.07	07.09	BA2258		23482 16,4 +	ATE
--	-----	-----	-------	-------	--------	--	--------------	-----

















### OPEL MERIVA A / Vauxhall Meriva A (02-10)

	1.4 16V	66	07.04	05.10	BA2210		23225 17,0 +/WK/S	LUC								
	1.4 LPG	66	07.04	05.10												
	1.6	64	05.03	05.10												
	1.3 CDTI	55	09.03	05.10					BA2255		23832 19,7 +/WK	ATE				
	1.6	77	01.06	05.10												
	1.6 16V	74	05.03	05.10												
	1.6 Turbo OPC	132	09.05	05.10												
	1.7 CDTI	74	09.03	05.10												
1.7 CDTI	92	09.06	05.10													
1.7 DTI 16V		09.02	05.10													
1.8 16V		09.02	05.10													
	1.4 16V	66	07.04	05.10	BAR24166	für 4-Loch-Felge <sup>2)</sup>	260 24,0 21,0 V L									
	1.4 LPG	66	07.04	05.10												
	1.6	64	05.03	05.10												
	1.3 CDTI	55	09.03	05.10					BAR25148	für 4-Loch-Felge <sup>2)</sup>	280 25,0 22,0 V L					
	1.6	77	01.06	05.10												
	1.6 16V	74	05.03	05.10												
	1.7 DTI 16V		09.02	05.10												
	1.8 16V		09.02	05.10												
	1.4 16V	66	07.04	05.10									BAR25131	für 5-Loch-Felge <sup>3)</sup>	280 25,0 22,0 V L	
	1.4 LPG	66	07.04	05.10												
1.6	64	05.03	05.10													
1.6	77	01.06	05.10													
1.6 16V	74	05.03	05.10													
1.7 CDTI	74	09.03	05.10													

<sup>1)</sup> + brake disc 257mm / + dischi freno 257mm / + disque de frein 257mm / + disco de freno 257mm

<sup>2)</sup> for 4 bore wheel rim / per cerchione a 4 fori / pour jante à 4 trous / para Llantas de 4 taladros

<sup>3)</sup> for 5 bore wheel rim / per cerchione a 5 fori / pour jante à 5 trous / para Llantas de 5 taladros

								
<b>OPEL MERIVA A / Vauxhall Meriva A (02-10)</b>								
	1.7 CDTI 1.7 DTI 16V 1.8 16V	92	09.06 09.02 09.02	05.10 05.10 05.10	BAR25131		für 5-Loch-Felge <sup>1)</sup>	280 25,0 22,0 V L
	1.6 Turbo OPC	132	09.05	05.10	BAR25142			308 25,0 22,0 V L
	1.3 CDTI 1.4 16V 1.4 LPG 1.6 1.6 1.6 16V 1.6 Turbo OPC 1.7 CDTI 1.7 CDTI 1.7 DTI 16V 1.8 16V	55 66 66 64 77 74 132 74 92	09.03 07.04 07.04 05.03 01.06 05.03 09.05 09.03 09.06 09.02 09.02	05.10 05.10 05.10 05.10 05.10 05.10 05.10 05.10 05.10 05.10 05.10	BA2194			23417 15,2 +/-WK/S LUC
	1.4 16V 1.4 LPG 1.6	66 66 64	07.04 07.04 05.03	05.10 05.10 05.10	BAR10251		für 4-Loch-Felge <sup>2)</sup>	240 9,9 8,0
	1.3 CDTI 1.4 16V 1.4 LPG 1.6 1.6 1.6 16V 1.6 Turbo OPC 1.7 CDTI 1.7 CDTI 1.7 DTI 16V 1.8 16V	55 66 66 64 77 74 132 74 92	09.03 07.04 07.04 05.03 01.06 05.03 09.05 09.03 09.06 09.02 09.02	05.10 05.10 05.10 05.10 05.10 05.10 05.10 05.10 05.10 05.10 05.10	BAR10250		für 5-Loch-Felge <sup>1)</sup>	264 9,9 8,0
<b>OPEL MERIVA B (10-)</b>								
	1.3 CDTI 1.3 CDTI 1.4 1.4 1.4 EcoFlex 1.7 CDTi 1.7 CDTi 1.7 CDTi	55 70 74 103 88 74 81 96	06.10 06.10 06.10 06.10 06.10 06.10 06.10 06.10		BA2255			23832 19,7 +/-WK ATE
	1.3 CDTI 1.3 CDTI 1.4 1.4 EcoFlex 1.7 CDTi 1.7 CDTi 1.7 CDTi	55 70 74 88 74 81 96	06.10 06.10 06.10 06.10 06.10 06.10 06.10		BAR25131			280 25,0 22,0 V L
	1.4 1.7 CDTi 1.7 CDTi 1.7 CDTi	103 74 81 96	06.10 06.10 06.10 06.10		BAR25142			308 25,0 22,0 V L
	1.3 CDTI 1.3 CDTI 1.4 1.4 1.4 EcoFlex 1.7 CDTi 1.7 CDTi 1.7 CDTi	55 70 74 103 88 74 81 96	06.10 06.10 06.10 06.10 06.10 06.10 06.10 06.10		BA2194			23417 15,2 +/-WK/S LUC
	1.3 CDTI 1.3 CDTI 1.4 1.4 1.4 EcoFlex 1.7 CDTi 1.7 CDTi 1.7 CDTi	55 70 74 103 88 74 81 96	06.10 06.10 06.10 06.10 06.10 06.10 06.10 06.10		BAR10250			264 9,9 8,0
<b>OPEL MOVANO A (98-10)</b>								
	1.9 DTI 2.2 DTI 16V 2.5 CDTI 2.5 CDTI 2.5 CDTI 2.5 D 2.5 DTI 2.8 DTI 3.0 DTI	66 74 88 107 59	09.00 09.00 09.06 09.06 09.06 07.98 10.01 07.98 10.03	01.10 + 15" Rad <sup>3)</sup> 01.10 + 15" Rad <sup>3)</sup> 01.10 + 15" Rad <sup>3)</sup> 01.10 + 15" Rad <sup>3)</sup> 01.10 + 15" Rad <sup>3)</sup> 09.00 + 15" Rad <sup>3)</sup> 01.10 + 15" Rad <sup>3)</sup> 10.01 + 15" Rad <sup>3)</sup> 01.10 + 15" Rad <sup>3)</sup>	BA2320			23302 18,0 /WE BDX
	1.9 DTI 2.2 DTI 16V 2.5 CDTI 2.5 CDTI 2.5 CDTI 2.5 D 2.5 DTI 2.8 DTI 3.0 DTI	66 74 88 107 59	09.00 09.00 09.06 09.06 09.06 07.98 10.01 07.98 10.03	01.10 + 16" Rad <sup>4)</sup> 01.10 + 16" Rad <sup>4)</sup> 01.10 + 16" Rad <sup>4)</sup> 01.10 + 16" Rad <sup>4)</sup> 01.10 + 16" Rad <sup>4)</sup> 09.00 + 16" Rad <sup>4)</sup> 01.10 + 16" Rad <sup>4)</sup> 10.01 + 16" Rad <sup>4)</sup> 01.10 + 16" Rad <sup>4)</sup>	BA2251			23613 17,8 BOS

















<sup>1)</sup> for 5 bore wheel rim / per cerchione a 5 fori / pour jante à 5 trous / para Llantas de 5 taladros

<sup>2)</sup> for 4 bore wheel rim / per cerchione a 4 fori / pour jante à 4 trous / para Llantas de 4 taladros

<sup>3)</sup> + 15" wheel / + ruota 15" / + roue 15" / + rueda 15"

<sup>4)</sup> + 16" wheel / + ruota 16" / + roue 16" / + rueda 16"























								
<b>OPEL MOVANO A (98-10)</b>								
	1.9 DTI 2.2 DTI 16V 2.5 CDTI 2.5 CDTI 2.5 CDTI 2.5 D 2.5 DTI 2.8 DTI 3.0 DTI	66 74 88 107 59		09.00 09.00 09.06 09.06 09.06 07.98 10.01 07.98 10.03	01.10 01.10 01.10 01.10 01.10 01.10 01.10 01.10 01.10	+ 15" Rad <sup>1)</sup> + 15" Rad <sup>1)</sup> + 15" Rad <sup>1)</sup> + 15" Rad <sup>1)</sup> + 15" Rad <sup>1)</sup> + 15" Rad <sup>1)</sup> + 15" Rad <sup>1)</sup> + 15" Rad <sup>1)</sup> + 15" Rad <sup>1)</sup>	BAR24162	280 24,0 21,0 V
	1.9 DTI 2.2 DTI 16V 2.5 CDTI 2.5 CDTI 2.5 CDTI 2.5 D 2.5 DTI 2.8 DTI 3.0 DTI	66 74 88 107 59		09.00 09.00 09.06 09.06 09.06 07.98 10.01 07.98 10.03	01.10 01.10 01.10 01.10 01.10 01.10 01.10 01.10 01.10	+ 16" Rad <sup>2)</sup> + 16" Rad <sup>2)</sup> + 16" Rad <sup>2)</sup> + 16" Rad <sup>2)</sup> + 16" Rad <sup>2)</sup> + 16" Rad <sup>2)</sup> + 16" Rad <sup>2)</sup> + 16" Rad <sup>2)</sup> + 16" Rad <sup>2)</sup>	BAR28129	306 28,0 25,0 V
	1.9 DTI 2.2 DTI 16V 2.5 CDTI 2.5 CDTI 2.5 CDTI 2.5 D 2.5 DTI 2.8 DTI 3.0 DTI	66 74 88 107 59		09.00 09.00 09.06 09.06 09.06 07.98 10.01 07.98 10.03	01.10 01.10 01.10 01.10 01.10 09.00 01.10 01.10 01.10		BA2261	23669 16,8 /S BOS
<b>OPEL OMEGA B / Vauxhall Omega (94-03)</b>								
	2.0 2.0 16V		V1999999 V1999999	03.94 03.94		- Sonderfahrzeuge/ - Polizei <sup>3)</sup> - Sonderfahrzeuge/ - Polizei <sup>3)</sup>	BAV1049	2 Warnkontakt L=730mm
	2.0 2.0 16V 2.0 DTI 16V 2.2 16V 2.2 DTI 16V 2.5 DTI 2.5 TD 2.5 V6 3.0 V6 3.2 V6	W1000001 W1000001		09.99 09.99 09.97 10.99 09.00 09.01 04.94 03.94 04.94 02.01	08.00 08.00 08.03 08.03 08.03 08.03 09.00 01.01 08.03		BA2175 BAV1017	2 21368 18,3 /WE/S LUC Warnkontakt L=730mm
	2.0 2.0 16V 2.0 DTI 16V 2.2 16V 2.2 DTI 16V 2.5 DTI 2.5 TD 2.5 V6 2.6 V6 3.0 V6 3.2 V6	W1000001 W1000001		09.99 09.99 09.97 10.99 09.00 09.01 04.94 03.94 09.00 04.94 02.01	08.00 08.03 08.03 08.03 08.03 09.00 01.01 08.03		BAR28104	296 28,0 25,0 V L
	2.0 2.0 16V 2.0 DTI 16V 2.2 16V 2.2 DTI 16V 2.5 DTI 2.5 TD 2.5 V6 2.6 V6 3.0 V6 3.2 V6			03.94 03.94 09.97 10.99 09.00 09.01 04.94 03.94 09.00 04.94 02.01	09.99 09.99 08.00 08.03 08.03 08.03 08.03 08.03 08.03 01.01 08.03		BA2095	21050 15,7 ATE
	2.0 2.0 16V 2.0 DTI 16V 2.2 16V 2.2 DTI 16V 2.5 DTI 2.5 TD 2.5 V6 2.6 V6 3.0 V6 3.2 V6			03.94 03.94 09.97 10.99 09.00 09.01 04.94 03.94 09.00 04.94 02.01	09.99 09.99 08.00 08.03 08.03 08.03 08.03 09.00 08.03 01.01 08.03		BAR12131 BAR20171	286 12,0 10,0 286 20,0 18,0 V
<b>OPEL SIGNUM / Vauxhall Signum (03-08)</b>								
	1.8 1.8 1.9 CDTI 1.9 CDTI 1.9 CDTI 2.0 DTI 2.0 Turbo 2.2 2.2 DTI 3.0 V6 CDTI 3.2 V6	90 103 74 88 110		05.03 09.05 08.05 04.04 04.04 05.03 05.03 03.03 05.03 05.03 05.03	05.08 05.08 05.08 05.08 05.08 05.08 05.08 05.08 05.08 05.08 05.08		BA2236 BAV1020	1 für Bremssattel mit Kunststoffkolben - 08.2004 23402 20,4 +/WE ATE Warnkontakt L=686mm
		130	31068238 31068238	05.03 05.03				

<sup>1)</sup> + 15" wheel / + ruota 15" / + roue 15" / + rueda 15"

<sup>2)</sup> + 16" wheel / + ruota 16" / + roue 16" / + rueda 16"

<sup>3)</sup> - special vehicles/ - Police / - veicoli speciali/ - Polizia / - véhicule spécial/ - Police / - vehículo especial/ - Police

<sup>4)</sup> + for br.caliper +plastic piston / per pinza fr. +pistone plastica / pour étrier fr. +piston plastique / para pinza fr. + pistón plástico

								
<b>OPEL SIGNUM / Vauxhall Signum (03-08)</b>								
	1.8 1.8 1.9 CDTI 1.9 CDTI 1.9 CDTI 2.0 DTI 2.2 2.2 DTI	90 103 74 88 110		05.03 09.05 08.05 04.04 04.04 05.03 03.03 05.03	05.08 05.08 05.08 05.08 05.08 05.08 05.08 05.08			285 24,9 22,0 V L
	1.8 1.8 1.9 CDTI 1.9 CDTI 1.9 CDTI 2.0 DTI 2.0 Turbo 2.2 2.2 DTI 2.8 V6 Turbo 2.8 V6 Turbo 3.0 V6 CDTI 3.0 V6 CDTI 3.2 V6	90 103 74 88 110  169 130 135	71041573 71041573 71041573 71041573 71041573 71041573 71041573 71041573 71041573 71041573 71041573 71041573 71041573 71041573	05.03 09.05 08.05 04.04 04.04 05.03 05.03 03.06 09.05 05.03 09.05 05.03				23482 16,4 + ATE
	1.8 1.8 1.9 CDTI 1.9 CDTI 1.9 CDTI 2.0 DTI 2.0 Turbo 2.2 2.2 DTI 2.8 V6 Turbo 2.8 V6 Turbo 3.0 V6 CDTI 3.0 V6 CDTI 3.2 V6	90 103 74 88 110  169 130 135	71041574 71041574 71041574 71041574 71041574 71041574 71041574 71041574 71041574 71041574 71041574 71041574 71041574 71041574	05.08 05.08 05.08 05.08 05.08 05.08 05.08 05.08 05.08 05.08 05.08 05.08 05.08 05.08				23482 16,4 + ATE
	1.8 1.8 1.9 CDTI 1.9 CDTI 1.9 CDTI 2.0 DTI 2.2 2.2 DTI 2.8 V6 Turbo 2.8 V6 Turbo 3.0 V6 CDTI	90 103 74 88 110  169 135		05.03 09.05 08.05 04.04 04.04 05.03 03.03 05.03 03.06 09.05 09.05	05.08 05.08 05.08 05.08 05.08 05.08 05.08 05.08 05.08 05.08 05.08			278 12,0 10,0
<b>OPEL SPEEDSTER / Vauxhall VX220 (00-05)</b>								
	2.0 Turbo 2.2 16V			04.03 09.00	09.05 09.05			288 25,0 22,0 V L
	2.0 Turbo 2.2 16V			04.03 09.00	09.05 09.05			288 25,0 22,0 V L
<b>OPEL TIGRA / Vauxhall Tigra (94-00)</b>								
	1.4 16V 1.6 16V			07.94 07.94	12.00 08.98			20547 16,8 +/-WE ATE
	1.4 16V 1.6 16V			07.94 07.94	12.00 08.98		+ GG 4)	Rz 19,05 LUC
	1.4 16V 1.6 16V			07.94 07.94	12.00 08.98			200 x 29 HEB
<b>OPEL TIGRA TWIN TOP / Vau. Tigra Twin Top (04-09)</b>								
	1.3 CDTI 1.4 1.8	51 66 92		06.04 06.04 06.04	08.09 08.09 08.09			23225 17,0 +/-WK/S LUC
	1.3 CDTI 1.4 1.8	51 66 92		06.04 06.04 06.04	08.09 08.09 08.09			260 24,0 21,0 V L
	1.3 CDTI 1.4 1.8	51 66 92		06.04 06.04 06.04	08.09 08.09 08.09			200 x 46 HEB
<b>OPEL VECTRA A / Vauxhall Cavalier (89-95)</b>								
	1.4 1.4 1.6 1.6 1.7 D 1.7 D		N1038529 M5999999 N1038529 M5999999 N1038529 M5999999	09.88 09.88 09.88 09.88 09.88 09.88				20939 15,4 /WE DEL

1) - sports suspension / - sospensione sportiva / - châssis de sport / - suspensión deportiva  
2) + sports suspension/ - Police / + sospensione sportiva/ - Polizia / + châssis de sport/ - Police / + suspensión deportiva/ - Police  
3) - Police / - Polizia / - voiture de police / - Police  
4) + cast iron / + ghisa / + fonte grise / + fundición de gris

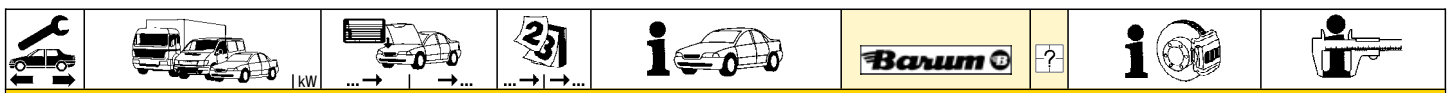









**OPEL VECTRA A / Vauxhall Cavalier (89-95)**

	1.7 TD 1.7 TD 1.8 1.8		N1038529 M5999999 N1038529 M5999999	09.88 09.88 09.88 09.88		BA2134		20939 15,4 /WE	DEL
	1.4 1.4 1.6 1.6 1.7 D 1.7 D 1.7 TD 1.7 TD 1.8 1.8	N1038530 N5000001 N1038530 N5000001 N5000001 N1038530 N5000001 N1038530 N5000001 N1038530		08.95 08.95 08.95 08.95		BA2136 BAV1027	2	20547 16,8 +/WE Warnkontakt L=685mm	ATE
	1.7 D 1.7 D 1.7 TD 1.7 TD 1.8 1.8 1.8 4x4 2.0 2.0 16V	S1000001 S5000001 S1000001 S5000001 S1000001 S5000001		08.95 08.95 08.95 08.95 08.95 08.95		BA2137 BAV1028	2	21190 17,5 +/WE Warnkontakt L=660mm	ATE
	2.0 Turbo 2.5 i			09.88 02.93	08.95 08.95	BAV1027	2	Warnkontakt L=685mm	
	1.4 1.4 1.6 1.6 1.7 D 1.7 D 1.7 TD 1.7 TD 1.8 1.8		N1038529 M5999999 N1038529 M5999999 N1038529 M5999999 N1038529 M5999999 N1038529 M5999999	09.88 09.88 09.88 09.88 09.88 09.88 09.88 09.88 09.88 09.88		BAR13161		236 12,7 10,7	
	1.4 1.4 1.6 1.6	N1038530 N5000001 N1038530 N5000001		08.95 08.95 08.95 08.95		BAR20115		236 20,0 17,0 V L	
	1.7 D 1.7 D 1.7 TD 1.7 TD 1.8 1.8 1.8 4x4 2.0 2.0 16V	S1000001 S5000001 S1000001 S5000001 S1000001 S5000001		08.95 08.95 08.95 08.95 08.95 08.95		BAR24115		256 24,0 21,0 V L	
	1.8 4x4 2.0 2.0 16V 2.0 16V 4x4 2.0 4x4 2.0 Turbo 2.5 i			09.88 09.88 09.88 09.88 09.88 03.92 02.93	08.89 08.95 08.95 08.95 08.95 08.95 08.95	BA2098		21140 15,7	ATE
	1.8 4x4 2.0 16V 2.0 16V 2.0 16V 2.0 16V 4x4 2.0 4x4		NV299999 N5299999 N1299999	09.88 09.88 09.88 09.88 09.88	08.89 08.95 08.95 08.95 08.95	BAR10205		270 9,9 8,0	
	2.0 2.0 16V	P1000001 P1000001		08.95 08.95		BAR10204		260 10,0 8,0	
	1.4 1.6 1.7 D 1.7 TD 1.8			09.88 09.88 09.88 09.88 09.88	08.95 08.95 08.95 08.95 08.95	BAW1904	+ GG <sup>1)</sup>	Rz 19,05	LUC
	1.4 1.6 1.7 D 1.7 TD 1.8	P1000001 P1000001 P1000001 P1000001 P1000001		08.95 08.95 08.95 08.95 08.95		BAE5011		200 x 46 HEB	

**OPEL VECTRA B / Vauxhall Vectra (96-02)**

	1.6 1.6 16V 1.7 TD 1.8 i 16V 2.0 DI 16V 2.0 DTI 16V		W7999999 W7999999 W7999999 W7999999 W7999999 W7999999	09.95 09.95 09.95 09.95 11.96 06.97		BA2137 BAV1030	2	21190 17,5 +/WE Warnkontakt L=660mm	ATE
	1.6 1.6 16V 1.8 i 16V 2.0 16V	X1000001 X1000001 X1000001		04.02 04.02 04.02 09.95		BA2207 BAV1016	2	21829 20,3 +/WE Warnkontakt L=660mm	ATE

<sup>1)</sup> + cast iron / + ghisa / + fonte grise / + fundición de gris

OPEL VECTRA B / Vauxhall Vectra (96-02)										
	2.0 DI 16V 2.0 DTI 16V 2.2 16V 2.2 DTI 16V 2.5 V6 2.6 V6	X1000001 X1000001		04.02 04.02 09.00 09.00 09.95 09.00	04.02 04.02 04.02 04.02 09.00 04.02	BA2207 BAV1016	2		21829 20,3 +/WE Warnkontakt L=660mm	ATE
	i 500 2.5	143		05.98	09.00	BA2207			21829 20,3 +/WE	ATE
	1.6 1.6 16V 1.7 TD 1.8 i 16V 2.0 DI 16V 2.0 DTI 16V		W7999999 W7999999 W7999999 W7999999 W7999999 W7999999	09.95 09.95 09.95 09.95 11.96 06.97	09.95 09.95 11.96 09.95 11.96 06.97	BAR24115			256 24,0 21,0 V L	
	1.6 1.6 16V 1.8 i 16V 2.0 16V 2.0 DI 16V 2.0 DTI 16V 2.2 16V 2.2 DTI 16V 2.5 V6 2.6 V6	X1000001 X1000001 X1000001 X1000001 X1000001 X1000001		04.02 04.02 04.02 09.95 04.02 04.02 09.00 09.00 09.95 09.00	04.02 04.02 04.02 04.02 04.02 04.02 04.02 04.02 09.00 04.02	BAR25119			288 25,0 22,0 V L	
	i 500 2.5	143		05.98	09.00	BAR25142			308 25,0 22,0 V L	
	1.6 16V 1.7 TD 1.8 i 16V 2.0 16V 2.0 DI 16V Caravan 2.0 DTI 16V 2.2 16V 2.2 DTI 16V 2.5 V6 2.6 V6			09.95 09.95 09.95 09.95 11.96 06.97 09.00 09.00 09.95 09.00	04.02 11.96 04.02 04.02 04.02 04.02 04.02 04.02 09.00 04.02	BA2095			21050 15,7	ATE
	1.6 16V 1.7 TD 1.8 i 16V 2.0 DI 16V Caravan 2.0 DTI 16V		W7999999 W7999999 W7999999 W7999999	09.95 09.95 09.95 11.96 06.97	09.95 11.96 09.95 11.96 06.97	BAR10225			270 10,0 8,0	
	1.6 16V 1.8 i 16V 2.0 16V 2.0 DI 16V Caravan 2.0 DTI 16V 2.2 16V 2.2 DTI 16V 2.5 V6 2.6 V6	X1000001 X1000001 X1000001 X1000001		04.02 04.02 09.95 04.02 04.02 09.00 09.00 09.95 09.00	04.02 04.02 04.02 04.02 04.02 04.02 04.02 09.00 04.02	BAR10226			286 10,0 8,0	
	1.6 1.6 1.6 2.0 DI 16V Limousine 2.0 DI 16V Limousine 2.0 DI 16V Limousine		W7152258 W5276825 W1238518 W7152258 W5276825 W1238518	09.95 09.95 09.95 11.96 11.96 11.96	09.95 09.95 09.95 11.96 11.96 11.96	BAW1904	+ GG <sup>1)</sup>		Rz 19,05	LUC
	1.6 2.0 DI 16V Limousine			09.95 11.96	04.02 04.02	BAE5012			230 x 42	
OPEL VECTRA C (F68,F69)/Vau. Vectra MK II (02-08)										
	1.6 1.6 1.6 16V 1.8 1.8 1.8 16V 1.9 CDTI 1.9 CDTI 1.9 CDTI 2.0 DTI 16V 2.0 Turbo 2.2 16V 2.2 direct 2.2 DTI 16V	74 77 81 103 90 74 88 110 108 114		08.05 01.06 04.02 04.02 01.06 04.02 10.05 04.04 04.04 04.02 03.03 04.02 10.03 04.02	10.08 10.08 10.08 10.08 10.08 10.08 10.08 10.08 10.08 10.08 10.08 10.08 10.08 10.08 10.08	BA2236 BAV1020	1	für Bremssattel mit Kunststoffkolben <sup>5)</sup> - 08.2004	23402 20,4 +/WE Warnkontakt L=686mm	ATE
	1.6 1.6 1.6 16V 1.8 1.8 1.8 16V 1.9 CDTI 1.9 CDTI 1.9 CDTI 2.0 DTI 16V 2.2 16V 2.2 direct 2.2 DTI 16V	74 77 81 103 90 74 88 110 108 114		08.05 01.06 04.02 04.02 01.06 04.02 10.05 04.04 04.04 04.02 03.03 04.02 10.03 04.02	10.08 10.08 10.08 10.08 10.08 10.08 10.08 10.08 10.08 10.08 10.08 10.08 10.08 10.08 10.08	BAR25141			285 24,9 22,0 V L	





1) + cast iron / + ghisa / + fonte grise / + fundición de gris

2) - sports suspension / - sospensione sportiva / - châssis de sport / - suspensión deportiva

















3) + sports suspension/ - Police / + sospensione sportiva/ - Polizia / + châssis de sport/ - Police / + suspensión deportiva/ - Police

4) - Police / - Polizia / - voiture de police / - Police

5) + for br.caliper +plastic piston / per pinza fr. +pistone plastica / pour étrier fr. +piston plastique / para pinza fr. + pistón plastic

OPEL VECTRA C (F68,F69)/Vau. Vectra MK II (02-08)									
	1.6	74	08.05	10.08	BA2235				23482 16,4 + ATE
	1.6	77	01.06	10.08					
	1.6 16V		04.02	10.08					
	1.8	81	04.02	10.08					
	1.8	103	01.06	10.08					
	1.8 16V	90	04.02	10.08					
	1.9 CDTI	74	10.05	10.08					
	1.9 CDTI	88	04.04	10.08					
	1.9 CDTI	110	04.04	10.08					
	2.0 DTI 16V		04.02	10.08					
	2.0 Turbo		03.03	10.08					
	2.2 16V	108	04.02	10.08					
	2.2 direct	114	10.03	10.08					
	2.2 DTI 16V		04.02	10.08					
	2.8 V6 Turbo	169	08.05	10.08					
	2.8 V6 Turbo	184	08.06	10.08					
	2.8 V6 Turbo OPC	188	08.05	10.08					
3.0 CDTI		05.03	10.08						
3.0 V6 CDTI	135	08.05	10.08						
3.2 V6		04.02	10.08						
	1.6	74	08.05	10.08	BAR12157				278 12,0 10,0
	1.6	77	01.06	10.08					
	1.6 16V		04.02	10.08					
	1.8	81	04.02	10.08					
	1.8	103	01.06	10.08					
	1.8 16V	90	04.02	10.08					
	1.9 CDTI	74	10.05	10.08					
	1.9 CDTI	88	04.04	10.08					
	1.9 CDTI	110	04.04	10.08					
	2.0 DTI 16V		04.02	10.08					
	2.0 Turbo		03.03	10.08					
	2.2 16V	108	04.02	10.08					
	2.2 direct	114	10.03	10.08					
	2.2 DTI 16V		04.02	10.08					
	2.8 V6 Turbo	169	08.05	10.08					
	2.8 V6 Turbo	184	08.06	10.08					
	2.8 V6 Turbo OPC	188	08.05	10.08					
3.0 CDTI		05.03	10.08						
3.0 V6 CDTI	135	08.05	10.08						
3.2 V6		04.02	10.08						
OPEL VECTRA C Caravan (F35) / Vau. MK II (03-08)									
	1.6	77	06.06	10.08	BA2236 BAV1020	1	für Bremssattel mit Kunststoffkolben <sup>4)</sup> - 08.2004		23402 20,4 +/WE Warnkontakt L=686mm
	1.6 16V	74	10.03	10.08					
	1.8	81	10.03	10.08					
	1.8	103	01.06	10.08					
	1.8 16V	90	10.03	10.08					
	1.9 CDTI	74	10.05	10.08					
	1.9 CDTI	88	04.04	10.08					
	1.9 CDTI	110	04.04	10.08					
	2.0 DTI 16V		10.03	10.08					
	2.0 Turbo		10.03	10.08					
	2.2 16V	108	10.03	10.08					
	2.2 direct	114	10.03	10.08					
2.2 DTI 16V		10.03	10.08						
	1.6	77	06.06	10.08	BAR25141				285 24,9 22,0 VL
	1.6 16V	74	10.03	10.08					
	1.8	81	10.03	10.08					
	1.8	103	01.06	10.08					
	1.8 16V	90	10.03	10.08					
	1.9 CDTI	74	10.05	10.08					
	1.9 CDTI	88	04.04	10.08					
	1.9 CDTI	110	04.04	10.08					
	2.0 DTI 16V		10.03	10.08					
	2.2 16V	108	10.03	10.08					
	2.2 direct	114	10.03	10.08					
	2.2 DTI 16V		10.03	10.08					
			- Sportfahrwerk <sup>1)</sup>						
			+ Sportfahrwerk/ - Polizei <sup>2)</sup>						
			- Sportfahrwerk <sup>1)</sup>						
			- Sportfahrwerk/ - Polizei <sup>3)</sup>						
			- Sportfahrwerk/ - Polizei <sup>3)</sup>						
			- Sportfahrwerk <sup>1)</sup>						
			- Sportfahrwerk <sup>1)</sup>						
			- Sportfahrwerk <sup>1)</sup>						
	1.6	77	06.06	10.08	BA2235				23482 16,4 + ATE
	1.6 16V	74	10.03	10.08					
	1.8	81	10.03	10.08					
	1.8	103	01.06	10.08					
	1.8 16V	90	10.03	10.08					
	1.9 CDTI	74	10.05	10.08					
	1.9 CDTI	88	04.04	10.08					
	1.9 CDTI	110	04.04	10.08					
	2.0 DTI 16V		10.03	10.08					
	2.0 Turbo		10.03	10.08					
	2.2 16V	108	10.03	10.08					
	2.2 direct	114	10.03	10.08					
	2.2 DTI 16V		10.03	10.08					
	2.8 V6 Turbo	169	08.05	10.08					
	2.8 V6 Turbo	184	11.06	10.08					
	2.8 V6 Turbo OPC	188	08.05	10.08					
	2.8 V6 Turbo OPC	206	06.06	10.08					
3.0 V6 CDTI	130	10.03	10.08						
3.0 V6 CDTI	135	08.05	10.08						
3.2 V6		10.03	10.08						

1) - sports suspension / - sospensione sportiva / - châssis de sport / - suspensión deportiva  
2) + sports suspension/ - Police / + sospensione sportiva/ - Polizia / + châssis de sport/ - Police / + suspensión deportiva/ - Police  
3) - sports suspens./ - Police / - sospensione sportiva/ - Polizia / - châssis de sport/ - Police / - suspens.deportiva/ - Police  
4) + for br.caliper +plastic piston / per pinza fr. +pistone plastica / pour étrier fr. +piston plastique / para pinza fr. + pistón plastic

        											
<b>OPEL VECTRA C Caravan (F35) / Vau. MK II (03-08)</b>											
	1.6	77	06.06	10.08	BAR12157			278 12,0 10,0			
	1.6 16V	74	10.03	10.08							
	1.8	81	10.03	10.08							
	1.8	103	01.06	10.08							
	1.8 16V	90	10.03	10.08							
	1.9 CDTI	74	10.05	10.08							
	1.9 CDTI	88	04.04	10.08							
	1.9 CDTI	110	04.04	10.08							
	2.0 DTI 16V		10.03	10.08							
	2.0 Turbo		10.03	10.08							
	2.2 16V	108	10.03	10.08							
	2.2 direct	114	10.03	10.08							
	2.2 DTI 16V		10.03	10.08							
	2.8 V6 Turbo	169	08.05	10.08							
	2.8 V6 Turbo	184	11.06	10.08							
	2.8 V6 Turbo OPC	188	08.05	10.08							
	2.8 V6 Turbo OPC	206	06.06	10.08							
	3.0 V6 CDTI	130	10.03	10.08							
	3.0 V6 CDTI	135	08.05	10.08							
	3.2 V6		10.03	10.08							
<b>OPEL VIVARO (01-)</b>											
	1.9 CDTI	60	08.01		BA2254			23099 18,4 /S	LUC		
	1.9 CDTI	74	08.01								
	1.9 Di	60	08.06								
	2.0	86	08.06								
	2.0 16V	88	08.01								
	2.0 CDTI	66	08.06								
	2.0 CDTI	84	08.06								
	2.5 CDTI	84	08.06								
	2.5 CDTI	99	05.03								
	2.5 CDTI	107	08.06								
	2.5 DTi	99	08.06								
	1.9 CDTI	60	08.01		BAR28132			306 28,0 24,0 V L			
	1.9 CDTI	74	08.01								
	1.9 Di	60	08.06								
	2.0	86	08.06								
	2.0 16V	88	08.01								
	2.0 CDTI	66	08.06								
	2.0 CDTI	84	08.06								
	2.5 CDTI	84	08.06								
	2.5 CDTI	99	05.03								
	2.5 CDTI	107	08.06								
	2.5 DTi	99	08.06								
	1.9 CDTI	60	08.01		BA2247			23980 16,0 /WE/S	LUC		
	1.9 CDTI	74	08.01								
	1.9 Di	60	08.06								
	2.0	86	08.06								
	2.0 16V	88	08.01								
	2.0 CDTI	66	08.06								
	2.0 CDTI	84	08.06								
	2.5 CDTI	84	08.06								
	2.5 CDTI	99	05.03								
	2.5 CDTI	107	08.06								
	2.5 DTi	99	08.06								
<b>OPEL ZAFIRA I / Vauxhall Zafira I (99-05)</b>											
	1.6 16V		04.99	06.05	BA2211			+ ABS	23057 19,6 +/WE	ATE	
	1.8 16V		04.99	06.05	BA2173			- ABS	23063 17,3 +/WK	ATE	
	2.0 DI 16V		10.99	06.05	BAV1014	2		bis Fgst.Nr.: 42187758 <sup>1)</sup>	Warnkontakt L=740mm		
	2.0 DTI 16V		06.00	06.05							
	2.2 16V		09.00	06.05							
	2.2 DTI 16V		01.02	06.05							
	2.0 16V OPC	42187758	09.01	06.05	BAV1014	2		bis Fgst.Nr.: 42187758 <sup>1)</sup>	Warnkontakt L=740mm		
	1.6 16V		04.99	06.05	BAR25131				280 25,0 22,0 V L		
	1.8 16V		04.99	06.05							
	2.0 DI 16V		10.99	06.05							
	2.0 DTI 16V		06.00	06.05							
	2.2 16V		09.00	06.05							
	2.2 DTI 16V		01.02	06.05							
	2.0 16V OPC		09.01	06.05	BAR25142				308 25,0 22,0 V L		
	1.6 16V		04.99	06.05	BA2197				23258 16,9 +/WK/Zub	BOS	
	1.8 16V		04.99	06.05	BA2194				23417 15,2 +/WK/S	LUC	
	2.0 16V OPC		09.01	06.05							
	2.0 DI 16V		10.99	06.05							
	2.0 DTI 16V		06.00	06.05							
	2.2 16V		09.00	06.05							
	2.2 DTI 16V		01.02	06.05							
	1.6 16V		04.99	06.05	BAR10250				264 9,9 8,0		
	1.8 16V		04.99	06.05							
	2.0 16V OPC		09.01	06.05							
	2.0 DI 16V		10.99	06.05							
	2.0 DTI 16V		06.00	06.05							
	2.2 16V		09.00	06.05							
	2.2 DTI 16V		01.02	06.05							













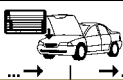





<sup>1)</sup> up to chassis: ... / fino no.telaio: ... / jusqu'au de chassis: ... / hasta no.de chasis: ...

<b>OPEL ZAFIRA I / Vauxhall Zafira I (99-05)</b>											
	1.6 16V		12999999	04.99	- D A GH	BAE5012					230 x 42
	1.6 16V	22000001			06.05 - D A GH	BAE5033					230 x 42 HEB
<b>OPEL ZAFIRA II / Vauxhall Zafira II (05-11)</b>											
	1.6	77		07.05	10.11	BA2255					23832 19,7 +/WK ATE
	1.6	85		12.07	10.11						
	1.6 CNG	69		01.06	10.11						
	1.6 CNG Turbo	110		02.09	10.11						
	1.7 CDTI	81		12.07	10.11						
	1.7 CDTI	92		12.07	10.11						
	1.8	103		07.05	10.11						
	1.9 CDTI	74		07.05	10.11						
	1.9 CDTI	88		07.05	10.11						
	1.9 CDTI	110		07.05	10.11						
	2.0	125		07.05	10.11						
	2.0 Turbo	147		07.05	10.11						
	2.2	110		07.05	10.11						
	2.0 OPC	177		09.05	10.11	BA2236		für Bremssattel mit Kunststoffkolben			23402 20,4 +/WE ATE
	1.6	77		07.05	10.11	BAR25131					280 25,0 22,0 V L
	1.6	85		12.07	10.11						
	1.8	103		07.05	10.11						
	1.6 CNG	69		01.06	10.11	BAR25142					308 25,0 22,0 V L
	1.6 CNG Turbo	110		02.09	10.11						
	1.7 CDTI	81		12.07	10.11						
	1.7 CDTI	92		12.07	10.11						
	1.9 CDTI	74		07.05	10.11						
	1.9 CDTI	88		07.05	10.11						
	1.9 CDTI	110		07.05	10.11						
	2.0	125		07.05	10.11						
	2.0 Turbo	147		07.05	10.11						
	2.2	110		07.05	10.11						
	1.6	77		07.05	10.11	BA2194					23417 15,2 +/WK/S LUC
	1.6	85		12.07	10.11						
	1.6 CNG	69		01.06	10.11						
	1.6 CNG Turbo	110		02.09	10.11						
	1.7 CDTI	81		12.07	10.11						
	1.7 CDTI	92		12.07	10.11						
	1.8	103		07.05	10.11						
	1.9 CDTI	74		07.05	10.11						
	1.9 CDTI	88		07.05	10.11						
	1.9 CDTI	110		07.05	10.11						
	2.0	125		07.05	10.11						
	2.0 OPC	177		09.05	10.11						
	2.0 Turbo	147		07.05	10.11						
	2.2	110		07.05	10.11						
	1.6	77		07.05	10.11	BAR10250					264 9,9 8,0
	1.6	85		12.07	10.11						
	1.7 CDTI	81		12.07	10.11						
	1.7 CDTI	92		12.07	10.11						
	1.8	103		07.05	10.11						
	1.9 CDTI	74		07.05	10.11						
	1.9 CDTI	88		07.05	10.11						
	1.9 CDTI	110		07.05	10.11						
	2.0	125		07.05	10.11						
	2.0 Turbo	147	52999999	07.05	10.11						
	2.2	110		07.05	10.11						
<b>PEUGEOT 106 (91-96)</b>											
	1.0		S 50994342	08.91		- ABS	BA2097		für 3-Loch-Felge 1)		21191 17,0 +/WK ATE
	1.1	44	S 50994342	08.91		- ABS	BA2066		für 4-Loch-Felge 2)		20906 18,0 +/WK BDX
	1.0		S 50994343		04.96	- ABS	BA2100		für 3-Loch-Felge 1)		21857 16,8 ATE
	1.1	44	S 50994343		04.96	- ABS	BA2083		für 4-Loch-Felge 2)		20905 18,0 +/WE BDX
	1.0			08.91	04.96	+ ABS	BA2066				20906 18,0 +/WK BDX
	1.1	44		08.91	04.96	+ ABS					
	1.4	55	S 50994342	08.91		- ABS	BA2066				20906 18,0 +/WK BDX
	1.4 D	37	S 50994342	08.92		- ABS					
	1.5 D		S 50994342	06.94		- ABS					
	1.6	65	S 50994342	06.93		- ABS					
	1.4	55	S 50994343		04.96	- ABS	BA2083				20905 18,0 +/WE BDX
	1.4 D	37	S 50994343		04.96	- ABS					
	1.5 D		S 50994343		04.96	- ABS					
	1.6	65	S 50994343		04.96	- ABS					
	1.3 Rallye	72	S 51132346	10.93			BA2066				20906 18,0 +/WK BDX
	1.4	55	S 51132346	08.91		+ ABS					
	1.4	69	S 51132346	08.91	04.96						
	1.4 D	37	S 51132346	08.92		+ ABS					
	1.5 D		S 51132346	06.94		+ ABS					
	1.6	65	S 51132346	06.93		+ ABS					
	1.6	76	S 51132346	01.94							
	1.3 Rallye	72	S 51132347		04.96		BA2151				21827 17,3 + ATE
	1.4	55	S 51132347		04.96	+ ABS					
	1.4 D	37	S 51132347		04.96	+ ABS					
	1.5 D		S 51132347		04.96	+ ABS					
	1.6	65	S 51132347		04.96	+ ABS					

1) for 3 bore wheel rim / per cerchione a 3 fori / pour jante à 3 trous / para Llantas de 3 taladros

















2) for 4 bore wheel rim / per cerchione a 4 fori / pour jante à 4 trous / para Llantas de 4 taladros

3) + for br.caliper +plastic piston / per pinza fr. +pistone plastica / pour étrier fr. +piston plastique / para pinza fr. + pistón plastic

PEUGEOT 106 (91-96)									
									
	1.6	76 S 51132347		04.96		BA2151			21827 17,3 + ATE
	1.0			08.91 04.96	- ABS	BAR08107			238 8,0 6,0
	1.1	44		08.91 04.96	- ABS	BAR10187			247 10,0 8,0
	1.0			08.91 04.96	+ ABS	BAR20132			247 20,4 18,5 V
	1.1	44		08.91 04.96	+ ABS				
	1.4	55		08.91 04.96	- ABS	BAR10187			247 10,0 8,0
	1.4 D	37		08.92 04.96	- ABS				
	1.5 D			06.94 04.96	- ABS				
	1.6	65		06.93 04.96	- ABS				
	1.3 Rallye	72		10.93 04.96		BAR20132			247 20,4 18,5 V
	1.4	55		08.91 04.96	+ ABS				
	1.4	69		08.91 04.96					
1.4 D	37		08.92 04.96	+ ABS					
1.5 D			06.94 04.96	+ ABS					
1.6	65		07.94 04.96	+ ABS					
1.6	76		07.94 04.96						
	1.0			08.91 04.96	- ABS/ + 3 türig <sup>1)</sup>	BAW1913	<input type="checkbox"/>	+ 4-Loch-Felge <sup>2)</sup>	RzR 19,05
	1.1	44		08.91 04.96	- ABS/ + 3 türig <sup>1)</sup>	BAW1912	<input type="checkbox"/>	+ 4-Loch-Felge <sup>2)</sup>	RzR 19,05
	1.0			08.91 04.96	- ABS/ + 5 türig <sup>3)</sup>	BAW1909	<input type="checkbox"/>	+ 3-Loch-Felge <sup>4)</sup>	RzR 19,05
	1.1	44		08.91 04.96	- ABS/ + 5 türig <sup>3)</sup>	BAW1910	<input type="checkbox"/>	+ 3-Loch-Felge <sup>4)</sup>	RzR 19,05
	1.3 Rallye	72		10.93 04.96	- ABS	BAW1913	<input type="checkbox"/>		RzR 19,05
	1.4	55		08.91 04.96	- ABS	BAW1912	<input type="checkbox"/>		RzR 19,05
	1.4	69		08.91 04.96	- ABS				
	1.4 D	37		08.92 04.96	- ABS				
	1.5 D			06.94 04.96	- ABS				
	1.6	65		06.93 04.96	- ABS				
	1.6	76		01.94 04.96	- ABS				
	1.0			08.91 04.96	- ABS/ + 3 türig <sup>1)</sup>	BAE5020		+ 4-Loch-Felge <sup>2)</sup>	180 x 32 AUT BDX
	1.1	44		08.91 04.96	- ABS/ + 3 türig <sup>1)</sup>				
	1.0			08.91 04.96	- ABS/ + 5 türig <sup>3)</sup>	BAE5014		+ 3-Loch-Felge <sup>4)</sup>	164 x 32 AUT
	1.1	44		08.91 04.96	- ABS/ + 5 türig <sup>3)</sup>				
	1.0			08.91 04.96	+ ABS	BAE5020			180 x 32 AUT BDX
	1.1	44		08.91 04.96	+ ABS				
	1.3 Rallye	72		10.93 04.96		BAE5020			180 x 32 AUT BDX
	1.4	55		08.91 04.96					
	1.4	69		08.91 04.96					
	1.4 D	37		08.92 04.96					
	1.5 D			06.94 04.96					
1.6	65		06.93 04.96						
1.6	76		01.94 04.96						
PEUGEOT 106 (96-04)									
	1.0			05.96 03.04		BA2097		für 3-Loch-Felge <sup>5)</sup>	21191 17,0 +/-WK ATE
	1.1			05.96 03.04		BA2100		für 3-Loch-Felge <sup>5)</sup>	21857 16,8 ATE
	1.1	42		09.00 10.02		BA2066		für 4-Loch-Felge <sup>6)</sup>	20906 18,0 +/-WK BDX
						BA2083		für 4-Loch-Felge <sup>6)</sup>	20905 18,0 +/-WE BDX
	1.4	55		05.96 03.04		BA2066			20906 18,0 +/-WK BDX
	1.5 D			05.96 03.04		BA2083			20905 18,0 +/-WE BDX
	1.6	65		05.96 03.04					
	1.6	74		05.96 03.04		BA2151			21827 17,3 + ATE
	1.6 16V	87		05.96 03.04					
	1.0			05.96 03.04		BAR08107			238 8,0 6,0
	1.1			05.96 03.04		BAR10187			247 10,0 8,0
	1.1	42		09.00 10.02					
	1.4	55		05.96 03.04		BAR10187			247 10,0 8,0
	1.5 D			05.96 03.04					
	1.6	65		05.96 03.04					
	Electric	20		04.96 07.04					
	1.6	74		05.96 03.04		BAR20132			247 20,4 18,5 V
	1.6 16V	87		05.96 03.04					
	1.6	74		05.96 03.04		BA2076			20973 11,0 + BDX
	1.6 16V	87		05.96 03.04					
	1.6	74		05.96 03.04		BAR08106			247 8,0 6,0
	1.6 16V	87		05.96 03.04					
	1.0			05.96 03.04	- ABS	BAW1909	<input type="checkbox"/>	für 3-Loch-Felge <sup>5)</sup>	RzR 19,05
	1.1			05.96 03.04	- ABS	BAW1910	<input type="checkbox"/>	für 3-Loch-Felge <sup>5)</sup>	RzR 19,05
	1.1	42		09.00 10.02	- ABS	BAW1913	<input type="checkbox"/>	für 4-Loch-Felge <sup>6)</sup>	RzR 19,05
						BAW1912	<input type="checkbox"/>	für 4-Loch-Felge <sup>6)</sup>	RzR 19,05
	1.0		ORGA 08056	05.96	+ ABS	BAW2001			Rz 20,64
	1.1		ORGA 08056	05.96	+ ABS				
	1.1	42	ORGA 08056	09.00	+ ABS				
	1.4	55		05.96 03.04	- ABS	BAW1913	<input type="checkbox"/>		RzR 19,05
	1.5 D			05.96 03.04	- ABS	BAW1912	<input type="checkbox"/>		RzR 19,05
	1.6	65		05.96 03.04	- ABS				
	1.4	55	ORGA 08056	05.96	+ ABS	BAW2001			Rz 20,64
1.5 D		ORGA 08056	05.96	+ ABS					
1.6	65	ORGA 08056	05.96	+ ABS					

<sup>1)</sup> - ABS/ + 3 door / - ABS/ + 3 porte / - ABS/ + 3 portes / - ABS/ + 3 puertas  
<sup>2)</sup> + 4 bore wheel rim / + cerchione a 4 fori / + jante à 4 trous / + Llantas de 4 taladros  
<sup>3)</sup> - ABS/ + 5 door / - ABS/ + 5 porte / - ABS/ + 5 portes / - ABS/ + 5 puertas  
<sup>4)</sup> + 3 bore wheel rim / + cerchione a 3 fori / + jante à 3 trous / + Llantas de 3 taladros  
<sup>5)</sup> for 3 bore wheel rim / per cerchione a 3 fori / pour jante à 3 trous / para Llantas de 3 taladros  
<sup>6)</sup> for 4 bore wheel rim / per cerchione a 4 fori / pour jante à 4 trous / para Llantas de 4 taladros



															
<b>PEUGEOT 106 (96-04)</b>															
	1.0				05.96	03.04	- ABS		BAE5014		für 3-Loch-Felge <sup>1)</sup>	164 x 32 AUT	<b>BDX</b>		
	1.1				05.96	03.04	- ABS		BAE5020		für 4-Loch-Felge <sup>2)</sup>	180 x 32 AUT			
	1.1	42			09.00	10.02	- ABS								
	1.0				05.96	03.04	+ ABS		BAE5002			203 x 38 HEB	<b>LUC</b>		
	1.1				05.96	03.04	+ ABS								
	1.1	42			09.00	10.02	+ ABS								
	1.4				05.96	03.04	- ABS		BAE5020			180 x 32 AUT	<b>BDX</b>		
	1.5 D				05.96	03.04	- ABS								
	1.6	65			05.96	03.04	- ABS								
1.4				05.96	03.04	+ ABS		BAE5002			203 x 38 HEB	<b>LUC</b>			
1.5 D				05.96	03.04	+ ABS									
1.6	65			05.96	03.04	+ ABS									
Electric		20			04.96	07.04		BAE5020			180 x 32 AUT	<b>BDX</b>			
<b>PEUGEOT 107 (05-)</b>															
	1.0	50			06.05				BA2296			23959 17,6 /S	<b>BOS</b>		
	1.4 HDi	40			06.05										
<b>PEUGEOT 205 (91-98)</b>															
	1.0	33			09.90	09.98			BA2055			20905 18,0 +/WK	<b>BDX</b>		
	1.1				09.90	09.98			BA2036			20989 17,5 +/WK		<b>LUC</b>	
	1.4				09.90	09.98									
	1.6				09.90	09.98									
	1.7 D	44			03.94	09.98									
	1.9 D	47			09.90	09.98									
	1.1 i	44			09.90	09.98			BA2055			20905 18,0 +/WK	<b>BDX</b>		
	1.4 i	55			09.90	09.98			BA2036			20989 17,5 +/WK		<b>LUC</b>	
	1.6 i	66			09.90	09.98									
	1.9 GTI/CTI	75			09.90	07.94									
1.7 TD	57			09.90	09.98			BA2140			21430 17,3 +/WK	<b>ATE</b>			
1.9 GTI	88			09.90	10.94			BA2140			21430 17,3 +/WK				
1.9 GTI	94			09.90	09.98										
	1.0	33			09.90	09.98			BAR10187			247 10,0 8,0	<b>BDX</b>		
	1.1				09.90	09.98									
	1.1 i	44			09.90	09.98									
	1.4				09.90	09.98									
	1.7 D	44			09.90	09.98									
	1.7 TD	57			09.90	09.98									
	1.9 D	47			09.90	09.98									
	1.7 TD	57			01.91	09.98			BAR20132			247 20,4 18,5 V			
	1.9 GTI	88			09.90	10.94									
1.9 GTI	94			09.90	09.98										
	1.9 GTI	88			09.90	10.94			BA2076			20973 11,0 +	<b>BDX</b>		
	1.9 GTI	94			09.90	09.98									
	1.0	33			09.90	09.98			BAE5020			180 x 32 AUT	<b>BDX</b>		
	1.1				09.90	09.98									
	1.1 i	44			09.90	09.98									
	1.4				09.90	09.98									
	1.4 i	55			09.90	09.98									
	1.6				09.90	09.98									
	1.6 i	66			09.90	09.98									
	1.7 TD	57			09.90	09.98	- ABS								
	1.9 D Lim.	47			09.90	09.98									
<b>PEUGEOT 206 Limousine (98-09)</b>															
	1.1				09.98	02.09			BA2089			23597 18,0 +/S	<b>BOS</b>		
	1.4	55			09.98	02.09									
	1.4 HDi	50			09.01	02.09									
	1.4 HDi	51			09.02	02.07									
	1.4 Roland Garros	55			09.98	02.09	- ABS	⌚							
	1.4HDI eco 70				09.09										
	1.6	65			09.98	12.00	- ABS	⌚							
	1.9 D	51			09.98	02.09	- ABS								
	1.4 16V	65			10.03	02.09			BA2214			23599 19,0 /S			
	1.6 16V	80	ORGA 09079			02.09									
1.6 HDi 110	80			05.04	02.09										
2.0 HDi	66	ORGA 09079			02.09										
2.0 S16	100	ORGA 09079			02.09										
2.0 RC	130			07.03	02.09			BA2229			23600 19,0 /S	<b>BOS</b>			
	1.1		ORGA 09975			02.09	- belüftete Scheiben <sup>3)</sup>		BAR13185			247 13,0 11,0	<b>BDX</b>		
	1.4	55			09.98	02.09	- ROL GAR								
	1.4 HDi	50			09.01	02.09									
	1.4 HDi	51			09.02	02.07									
	1.4HDI eco 70				09.08										
	1.1		ORGA 08988		09.98		- Ⓟ		BAR10187			247 10,0 8,0			
	1.1		ORGA 09975			02.09	+ belüftete Scheiben <sup>4)</sup>		BAR20132			247 20,4 18,5 V			
	1.4 HDi	50			09.01	02.09									
	1.4 HDi	51			09.02	02.07									
1.4 Roland Garros	55			09.98	02.09										
1.4HDI eco 70				09.08											
1.6	65			09.98	12.00										

1) for 3 bore wheel rim / per cerchione a 3 fori / pour jante à 3 trous / para Llantas de 3 taladros

2) for 4 bore wheel rim / per cerchione a 4 fori / pour jante à 4 trous / para Llantas de 4 taladros

3) - ventilated discs / - dischi ventilati / - disques ventilés / - disco ventilado

4) + ventilated discs / + dischi ventilati / + disques ventilés / + disco ventilado



### PEUGEOT 206 Limousine (98-09)

	1.9 D	51		09.98	02.09		BAR20132		247 20,4 18,5 V
	1.6 16V	80	ORGA 09078	12.00			BAR20133		266 20,5 18,5 V
	2.0 HDi	66	ORGA 09078	12.99					
	2.0 S16	99		04.99	10.00				
	2.0 S16	100	ORGA 09078	10.00					
	1.4 16V	65		10.03	02.09		BAR22194		266 22,0 20,0 V
	1.6 16V	80	ORGA 09079		02.09				
	1.6 HDi 110	80		05.04	02.09				
2.0 HDi	66	ORGA 09079		02.09					
2.0 S16	100	ORGA 09079		02.09					
2.0 RC	130		07.03	02.09		BAR26120		283 26,0 24,0 V	
	1.1			09.98	02.09		BAH0031	2	L=310
	1.4	55		09.98	02.09				
	1.4 16V	65		10.03	02.09				
	1.4 HDi	50		09.01	02.09				
	1.4 HDi	51		09.02	02.07				
	1.4 HDi eco 70			09.08					
	1.6	65		09.98	12.00				
	1.6 16V	80		12.00	02.09				
	1.6 HDi 110	80		05.04	02.09				
	1.9 D	51		09.98	02.09				
	2.0 HDi	66		12.99	02.09				
	2.0 RC	130		07.03	02.09				
	2.0 S16	99		04.99	10.00				
	2.0 S16	100		10.00	02.09				
	1.4 16V	65		10.03	02.09		BA2076		20973 11,0 + BDX
	1.6 16V	80		12.00	02.09				
	1.6 HDi 110	80		05.04	02.09				
	2.0 RC	130		07.03	02.09				
	2.0 S16	99		04.99	10.00				
	2.0 S16	100		10.00	02.09				
	1.4 16V	65		10.03	02.09		BAR08106		247 8,0 6,0
	1.6 16V	80		12.00	02.09				
	1.6 HDi 110	80		05.04	02.09				
	2.0 RC	130		07.03	02.09				
	2.0 S16	99		04.99	10.00				
	2.0 S16	100		10.00	02.09				
	1.1		ORGA 09456	09.98		+ ABS	BAE5002		203 x 38 HEB LUC
	1.4	55	ORGA 09456	09.98		+ ABS			
1.4 HDi	50	ORGA 09456	09.01		+ ABS				
1.4 HDi	51	ORGA 09456	09.02		+ ABS				
1.4 HDi eco 70			09.08						
1.6	65		09.98	12.00	+ ABS				
1.9 D	51	ORGA 09456	09.98		+ ABS				
2.0 HDi	66	ORGA 09456	12.99						

### PEUGEOT 206 CC (00-07)





















	CC 110	80	ORGA 09079				BA2214		23599 19,0 /S BOS
	CC 135	100	ORGA 09079		01.07				
	CC HDi 110	80		04.05	01.07				
	CC 110	80	ORGA 09078	09.00			BAR20133		266 20,5 18,5 V
	CC 135	100	ORGA 09078	09.00					
	CC 110	80	ORGA 09079		01.07		BAR22194		266 22,0 20,0 V
	CC 135	100	ORGA 09079		01.07				
CC HDi 110	80		04.05	01.07					
	CC 110	80		09.00	01.07		BAH0031	2	L=310
	CC 135	100		09.00	01.07				
	CC HDi 110	80		04.05	01.07				
	CC 110	80		09.00	01.07		BA2076		20973 11,0 + BDX
	CC 135	100		09.00	01.07				
	CC HDi 110	80		04.05	01.07				
	CC 110	80		09.00	01.07		BAR08106		247 8,0 6,0
	CC 135	100		09.00	01.07				
	CC HDi 110	80		04.05	01.07				

















### PEUGEOT 206 SW (02-07)

	1.1	44		07.02	05.07		BA2089		23597 18,0 +/S BOS
	1.4	55		07.02	05.07				
	1.4 HDi	50		07.02	05.07				
	1.4 16V	65		10.03	05.07		BA2214		23599 19,0 /S BOS
	1.6 16V	80	ORGA 10808	07.02					
1.6 HDi 110	80		05.04	05.07					
2.0 HDi	66	ORGA 10808	07.02						
2.0 S16	100		07.02	05.07					
	1.1	44		07.02	05.07		BAR13185		247 13,0 11,0
	1.4	55		07.02	05.07	- belüftete Scheiben 1)			
	1.4 HDi	50		07.02	05.07	- belüftete Scheiben 1)			
	1.4	55		07.02	05.07	+ belüftete Scheiben 2)	BAR20132		247 20,4 18,5 V
	1.4 HDi	50		07.02	05.07	+ belüftete Scheiben 2)			
	1.4 16V	65		10.03	05.07		BAR22194		266 22,0 20,0 V
	1.6 16V	80		07.02	05.07				
	1.6 HDi 110	80		05.04	05.07				
	2.0 HDi	66		07.02	05.07				
2.0 S16	100		07.02	05.07					

1) - ventilated discs / - dischi ventilati / - disques ventilés / - disco ventilado

2) + ventilated discs / + dischi ventilati / + disques ventilés / + disco ventilado

	   kW							
<b>PEUGEOT 206 SW (02-07)</b>								
	1.1 44 1.4 55 1.4 16V 65 1.4 HDi 50 1.6 16V 80 1.6 HDi 110 80 2.0 HDi 66 2.0 S16 100		07.02 05.07 07.02 05.07 10.03 05.07 07.02 05.07 07.02 05.07 05.04 05.07 07.02 05.07 07.02 05.07		BAH0031	2		L=310
	1.4 16V 65 1.6 16V 80 1.6 HDi 110 80 2.0 S16 100		10.03 05.07 07.02 05.07 05.04 05.07 07.02 05.07		BA2076			20973 11,0 + BDX
	1.4 16V 65 1.6 16V 80 1.6 HDi 110 80 2.0 S16 100		10.03 05.07 07.02 05.07 05.04 05.07 07.02 05.07		BAR08106			247 8,0 6,0
	1.1 44 1.4 55 1.4 HDi 50 2.0 HDi 66	ORGA 09456 ORGA 09456 ORGA 09456 ORGA 09456	07.02 07.02 07.02 07.02		BAE5002			203 x 38 HEB LUC
<b>PEUGEOT 206 PLUS (09-)</b>								
	1.1 44 1.4 HDi eco 70 50 1.4 i 54 1.4 i 55		01.09 + ⊕ 01.09 + ⊕ 09.10 + ⊕ 01.09 + ⊕		BA2089			23597 18,0 +/S BOS
	1.1 44 1.4 HDi eco 70 50 1.4 i 54 1.4 i 55		01.09 + ⊕ 01.09 + ⊕ 09.10 + ⊕ 01.09 + ⊕		BAR20132			247 20,4 18,5 V
	1.1 44 1.4 HDi eco 70 50 1.4 i 54 1.4 i 55		01.09 - ⊖ 01.09 - ⊖ 09.10 - ⊖ 01.09 - ⊖		BAR13185			247 13,0 11,0
	1.1 44 1.4 HDi eco 70 50 1.4 i 54 1.4 i 55		01.09 01.09 09.10 01.09		BAH0031	2		L=310
<b>PEUGEOT 207 Limousine (06-)</b>								
	1.4 53 1.4 55 1.4 16V 65 1.4 HDi 50 1.6 HDi 66 1.6 HDi 68		02.06 09.07 02.06 02.06 02.06 11.09		BA2214			23599 19,0 /S BOS
	1.4 16V VTi 70 1.6 16V 80 1.6 16V Turbo 110 1.6 16V Turbo 115 1.6 16V VTi 88 1.6 HDi 66 1.6 HDi 80 1.6 HDi 110 82		08.07 02.06 02.06 01.10 02.07 02.06 02.06 08.09		BA2229			23600 19,0 /S BOS
	1.4 53 1.4 55 1.4 16V 65 1.4 HDi 50 1.6 HDi 66 1.6 HDi 68		02.06 09.07 02.06 02.06 02.06 11.09	- ⊖	BAR22194			266 22,0 20,0 V
	1.4 16V VTi 70 1.6 16V 80 1.6 16V Turbo 110 1.6 16V Turbo 115 1.6 16V VTi 88 1.6 HDi 66 1.6 HDi 80 1.6 HDi 110 82		08.07 02.06 02.06 01.10 10.06 02.06 02.06 08.09		BAR26120			283 26,0 24,0 V
	1.6 16V 80 1.6 16V Turbo 110 1.6 16V Turbo 115 1.6 16V VTi 88 1.6 HDi 66 1.6 HDi 80 1.6 HDi 110 82	ORGA 1163482 ORGA 1163482 ORGA 1163482 ORGA 1163482 ORGA 1163482 ORGA 1163482 ORGA 1163482	02.06 02.06 10.09 10.06 02.06 02.06 08.09		BA2300			24150 17,6 /S BOS
<b>PEUGEOT 207 CC (07-)</b>								
	1.6 16V 88 1.6 16V Turbo 110 1.6 16V Turbo 115 1.6 HDi 80 1.6 HDi 82		02.07 02.07 10.09 02.07 08.09		BA2229			23600 19,0 /S BOS

								
<b>PEUGEOT 207 CC (07-)</b>								
	1.6 16V	88		02.07				283 26,0 24,0 V
	1.6 16V Turbo	110		02.07				
	1.6 16V Turbo	115		10.09				
	1.6 HDi	80		02.07				
	1.6 HDi	82		08.09				
<b>PEUGEOT 207 SW (07-)</b>								
	1.4 i	54		06.07				23599 19,0 /S BOS
	1.4 i 16V	70		06.07				23600 19,0 /S BOS
	1.6 HDi	68		11.09				
	1.6 HDi	82		08.09				
	1.6 HDi FAP 110	80		06.07				
	1.6 HDi FAP 90	66		06.07				
	1.6 i 16V	88		06.07				
	1.4 i	54	ORGA 11402	06.07				266 22,0 20,0 V
	1.4 i	54	ORGA 11403					266 22,0 20,0 V
	1.4 i 16V	70		06.07				283 26,0 24,0 V
	1.6 HDi	68		11.09				
	1.6 HDi	82		08.09				
	1.6 HDi FAP 110	80		06.07				
	1.6 HDi FAP 90	66		06.07				
	1.6 i 16V	88		06.07				
<b>PEUGEOT 208 (12-)</b>								
	1.0 VTi	50		01.12				23599 19,0 /S BOS
	1.2 VTi	60		01.12				
	1.4 HDi	50		01.12				
	1.4 VTi	70		01.12				
	1.6 e-HDi	68		01.12				
	1.6 e-HDi	84		01.12				
	1.6 THP	115		01.12				
	1.6 VTi	88		01.12				
	1.0 VTi	50		01.12				266 22,0 20,0 V
	1.2 VTi	60		01.12				
	1.4 HDi	50		01.12				
	1.4 VTi	70		01.12				
	1.6 e-HDi	68		01.12				
	1.6 e-HDi	84		01.12				
	1.6 THP	115		01.12				
	1.6 VTi	88		01.12				
<b>PEUGEOT 306 Limousine (3/5-türig) (93-01)</b>								
	1.1	44		03.94	04.97	- ABS	BA2074	20905 18,0 +/-WK BDX
	1.4	55		03.93	04.97	- ABS		
	1.4	55		05.97	05.01	- ABS	BA2089	23597 18,0 +/-S BOS
	1.1	44		03.94	04.97	+ ABS	BA2140	21430 17,3 +/-WK ATE
	1.4	55	ORGA 08575	03.93		+ ABS/ - Entreprise	BA2151	21827 17,3 + ATE
	1.4 Entreprise	55		03.93	05.01			
	1.6	65	ORGA 08575	03.93				
	1.6	65		05.00	10.00	- ABS		
	1.6	72		10.00	05.01	- ABS		
	1.8	74	ORGA 08575	03.93				
	1.8	74	ORGA 08576		05.01	- ABS		
	1.8 D	43		03.93	05.01			
	1.9 D	47		05.93	05.01			
	1.9 D	50		06.94	05.01			
	1.9 D	51	ORGA 08575	09.98				
	1.9 D	51	ORGA 08576		05.01	- ABS		
	1.9 D	55		03.98	05.01			
	1.9 D Entreprise			09.98	10.00	+ ABS		
	1.9 TD	66		10.93	05.01			
	1.4	55	ORGA 08576		05.01	+ ABS	BA2021	23124 19,0 +/-WK/S LUC
	1.6	65	ORGA 08576		10.00	+ ABS		
	1.6	72		10.00	05.01	+ ABS		
	1.8	74	ORGA 08576		05.01	+ ABS		
	1.8 16V	81		03.97	05.01			
	1.9 D	51		05.00	05.01	+ ABS/ - Entreprise		
	1.9 D Entreprise			10.00	05.01	+ ABS		
	2.0	89		05.97	05.01			
	2.0 16V			03.97	05.01			
	2.0 HDi	66		06.99	05.01			
	2.0 S16	110		05.97	05.01			
	2.0 S16	112		05.97	05.01			
	2.0 S16	110		03.94	04.97		BA2016	21674 19,3 /WK/S LUC
	2.0 S16	112		07.94	04.97			
	2.0 S16	120		03.96	05.01			
	1.1	44		03.94	04.97	- ABS	BAR10187	247 10,0 8,0
	1.4	55		03.93	04.97	- ABS		
	1.4	55		05.97	05.01	- ABS	BAR13185	247 13,0 11,0
	1.1	44		03.94	04.97	+ ABS	BAR20132	247 20,4 18,5 V
	1.4	55	ORGA 08575	03.93		+ ABS/ - Entreprise		
	1.4 Entreprise	55		03.93	05.01			
	1.6	65	ORGA 08575	03.93				
	1.6	65	ORGA 08576		10.00	- ABS		
	1.6	72		10.00	05.01	- ABS		





**PEUGEOT 306 Limousine (3/5-türig) (93-01)**

	1.8	74	ORGA 08575	03.93	05.01 - ABS	BAR20132		247 20,4 18,5 V
	1.8	74 ORGA 08576		03.93	05.01			
	1.8 D	43		05.93	05.01			
	1.9 D	47		06.94	05.01			
	1.9 D	50		09.98				
	1.9 D	51	ORGA 08575		05.01 - ABS			
	1.9 D	51 ORGA 08576		09.98	10.00 + ABS			
	1.9 D	55		03.98	05.01			
	1.9 TD	66		10.93	05.01			
	1.4	55 ORGA 08576			05.01 + ABS			
1.6	65 ORGA 08576		10.00	10.00 + ABS				
1.6	72			05.01 + ABS				
1.8	74 ORGA 08576			05.01 + ABS				
1.8 16V	81		03.97	05.01				
1.9 D	51	ORGA 08576		05.01 + ABS/- Entreprise				
1.9 D Entreprise			10.00	05.01 + ABS				
2.0	89		03.94	05.01				
2.0 16V			03.97	05.01				
2.0 HDi	66		06.99	05.01				
2.0 S16	110		05.97	05.01				
2.0 S16	112		05.97	05.01				
	1.8 16V	81		03.97	05.01	BA2076		20973 11,0 + BDX
	2.0	89		03.94	05.01			
	2.0 16V			03.97	05.01			
	2.0 HDi	66		06.99	05.01			
	2.0 S16	110		03.94	05.01			
	2.0 S16	112		07.94	05.01			
2.0 S16	120		03.96	05.01				
	1.8 16V	81		03.97	05.01	BAR08106		247 8,0 6,0
	2.0	89		03.94	05.01			
	2.0 16V			03.97	05.01			
	2.0 HDi	66		06.99	05.01			
	2.0 S16	110		03.94	05.01			
	2.0 S16	112		07.94	05.01			
2.0 S16	120		03.96	05.01				
	1.1	44	ORGA 08729	09.95	+ ABS	BAW2001		Rz 20,64 LUC
	1.4	55	ORGA 08729	09.95	+ ABS			
	1.6	65	ORGA 08729	09.95	+ ABS			
	1.8	74	ORGA 08729	09.95	+ ABS			
	1.8 D	43	ORGA 08729	09.95	+ ABS			
	1.9 D	51	ORGA 08729	09.95	+ ABS			
1.9 TD	66	ORGA 08729	09.95	+ ABS				
	1.1	44		09.95	04.97 + ABS	BAE5002		203 x 38 HEB LUC
	1.4	55 19950901		09.95	05.01 + ABS			
	1.6	65		09.95	10.00 + ABS			
	1.6	72		10.00	05.01 + ABS			
	1.8	74		09.95	05.01 + ABS			
	1.8 D	43		09.95	05.01 + ABS			
	1.9 D	51		09.95	05.01 + ABS			
	1.9 TD	66		09.95	05.01			









**PEUGEOT 306 Limousine (4-türig) (94-01)**

	1.4	55		10.94	04.97 - ABS	BA2074		20905 18,0 +/WK BDX
	1.4	55		05.97	05.01 - ABS	BA2089		23597 18,0 +/S BOS
	1.4	55	ORGA 08575	10.94	+ ABS	BA2140 BA2151		21430 17,3 +/WK 21827 17,3 + ATE ATE
	1.6	65 ORGA 08576		10.94	10.00 - ABS			
	1.6	72		10.00	05.01 - ABS			
	1.8	74	ORGA 08575	04.94				
	1.8	74 ORGA 08576			05.01 - ABS			
	1.9 D	47		10.94	05.01			
	1.9 D	50		10.94	05.01			
	1.9 D	51	ORGA 08575	09.98				
	1.9 D	51 ORGA 08576			05.01 - ABS			
	1.9 D	55		03.98	05.01			
	1.9 TD	66		10.94	05.01			
	1.4	55 ORGA 08576			05.01 + ABS			
	1.6	65 ORGA 08576		10.00	10.00 + ABS			
1.6	72			05.01 + ABS				
1.8	74 ORGA 08576			05.01 + ABS				
1.8 16V	81		03.97	05.01				
1.9 D	51 ORGA 08576			05.01 + ABS				
2.0	89		05.97	05.01				
2.0 16V	97		03.97	05.01				
2.0 HDi	66		06.99	05.01				
2.0 S16	110		05.97	05.01				
2.0 S16	112		05.97	05.01				
	1.4	55		10.94	04.97 - ABS	BAR10187		247 10,0 8,0
	1.4	55		05.97	05.01 - ABS	BAR13185		247 13,0 11,0
	1.4	55	ORGA 08575	10.94	+ ABS	BAR20132		247 20,4 18,5 V
	1.6	65		10.94	05.00			
	1.6	65 ORGA 08576			10.00 - ABS			
1.6	72		10.00	05.01 - ABS				
1.8	74	ORGA 08575	04.94					

**PEUGEOT 306 Limousine (4-türig) (94-01)**

	1.8	74	ORGA 08576		05.01	- ABS	BAR20132		247 20,4 18,5 V	
	1.9 D	47			10.94	05.01				
	1.9 D	50			10.94	05.01				
	1.9 D	51		ORGA 08575	09.98					
	1.9 D	51	ORGA 08576			05.01				- ABS
	1.9 D	55			03.98	05.01				
	1.9 TD	66			10.94	05.01				
	1.4	55			05.00	05.01				+ ABS
	1.6	65			05.00	10.00				+ ABS
	1.6	72			10.00	05.01				+ ABS
	1.8	74			05.00	05.01				+ ABS
	1.8 16V	81			03.97	05.01				+ ABS
1.9 D	51			05.00	05.01	+ ABS				
2.0	89			04.94	05.01					
2.0 16V	97			03.97	05.01					
2.0 HDi	66			06.99	05.01					
2.0 S16	110			05.97	05.01					
2.0 S16	112			05.97	05.01					
	1.8 16V	81			03.97	05.01	BA2076		20973 11,0 + BDX	
	2.0	89			04.94	05.01				
	2.0 16V	97			03.97	05.01				
	2.0 HDi	66			06.99	05.01				
	2.0 S16	110			06.94	05.01				
	2.0 S16	112			07.94	05.01				
	1.8 16V	81			03.97	05.01	BAR08106		247 8,0 6,0	
	2.0	89			04.94	05.01				
	2.0 16V	97			03.97	05.01				
	2.0 HDi	66			06.99	05.01				
	2.0 S16	110			06.94	05.01				
	2.0 S16	112			07.94	05.01				
	1.4	55	ORGA 08729	09.95		+ ABS	BAW2001		Rz 20,64 LUC	
	1.6	65	ORGA 08729	09.95		+ ABS				
	1.8	74	ORGA 08729	09.95		+ ABS				
	1.9 D		ORGA 08729	09.95		+ ABS				
	1.9 TD	66	ORGA 08729	09.95		+ ABS				
	1.4	55		09.95	05.01	+ ABS	BAE5002		203 x 38 HEB LUC	
	1.6	65		09.95	10.00	+ ABS				
	1.6	72		10.00	05.01	+ ABS				
	1.8	74		09.95	05.01	+ ABS				
	1.9 D			09.95	05.01	+ ABS				
	1.9 TD	66		09.95	05.01					

**PEUGEOT 306 Cabriolet (94-03)**

	1.6	65	ORGA 08575	04.96			BA2140 BA2151		21430 17,3 +WK 21827 17,3 + ATE
	1.6	65		05.00	10.00	- ABS			
	1.8	74	ORGA 08575	03.94					
	1.8	74		05.00	10.00	- ABS			
	1.8 16V	81	ORGA 08575	07.00					
	1.8 16V	81		07.00	04.02	- ABS			
	1.6	65	ORGA 08576		10.00	+ ABS	BA2021		23124 19,0 +WK/S LUC
	1.6	72		10.00	07.03				
	1.8	74	ORGA 08576		10.00	+ ABS			
	1.8 16V	81		07.00	04.02				
	2.0	89		03.94	04.97				
	2.0 16V	97		03.97	10.00				
	1.6	65	ORGA 08575	04.96			BAR20132		247 20,4 18,5 V
	1.6	65	ORGA 08576		10.00	- ABS			
	1.8	74	ORGA 08575	03.94					
	1.8	74	ORGA 08576		10.00	- ABS			
	1.6	65	ORGA 08576		10.00	+ ABS	BAR20133		266 20,5 18,5 V
	1.6	72		10.00	07.03				
	1.8	74	ORGA 08576		10.00	+ ABS			
	1.8 16V	81		07.00	07.03				
	2.0	89		03.94	04.97				
	2.0 16V	97		03.97	10.00				
	1.8 16V	81		07.00	07.03		BA2076		20973 11,0 + BDX
	2.0	89		03.94	04.97				
	2.0 16V	97		03.97	10.00				
	1.8 16V	81		07.00	07.03		BAR08106		247 8,0 6,0
	2.0	89		03.94	04.97				
	2.0 16V	97		03.97	10.00				
	1.6	65	ORGA 08729	04.96		+ ABS	BAW2001		Rz 20,64 LUC
	1.8	74	ORGA 08729	09.95		+ ABS			
	1.6	65		04.96	10.00	+ ABS	BAE5002		203 x 38 HEB LUC
	1.6	72		10.00	07.03	+ ABS			
	1.8	74		09.95	10.00	+ ABS			

**PEUGEOT 306 Kombi (97-02)**

	1.4	55		03.97	03.02	- ABS	BA2151		21827 17,3 + ATE
	1.6	65		03.97	10.00	- ABS			
	1.6	72		10.00	03.02	- ABS			
	1.8 D			03.97	03.02	- ABS			
	1.9 D	51		03.97	03.02	- ABS			
	1.4	55		03.97	03.02	+ ABS			
↓							BA2021		23124 19,0 +WK/S LUC

**PEUGEOT 306 Kombi (97-02)**

	1.6 1.6 1.8 1.8 16V 1.8 D 1.9 D 1.9 TD 2.0 16V 2.0 HDi	65 72 74 81 51 66 97 66		03.97 10.00 03.97 03.97 03.97 03.97 03.97 03.97 06.99	10.00 + ABS 03.02 + ABS 03.02 03.02 03.02 + ABS 03.02 + ABS 03.02 03.02	BA2021		23124 19,0 +WK/S	LUC
	1.4 1.6 1.6 1.8 D 1.9 D	55 65 72 51		03.97 03.97 10.00 03.97 03.97	03.02 - ABS 10.00 - ABS 03.02 - ABS 03.02 - ABS 03.02 - ABS	BAR20132		247 20,4 18,5 V	
	1.4 1.6 1.6 1.8 1.8 16V 1.8 D 1.9 D 1.9 TD 2.0 16V 2.0 HDi	55 65 72 74 81 51 66 97 66		03.97 03.97 10.00 03.97 03.97 03.97 03.97 03.97 06.99	03.02 + ABS 10.00 + ABS 03.02 + ABS 03.02 03.02 03.02 + ABS 03.02 + ABS 03.02 03.02	BAR20133		266 20,5 18,5 V	
	1.8 16V 2.0 16V 2.0 HDi	81 97 66		03.97 03.97 06.99	03.02 03.02 03.02	BA2076		20973 11,0 +	BDX
	1.8 16V 2.0 16V 2.0 HDi	81 97 66		03.97 03.97 06.99	03.02 03.02 03.02	BAR08106		247 8,0 6,0	

**PEUGEOT 307 Limousine (00-07)**







	1.4 1.4 16V 1.4 16V 1.4 HDi 1.6 16V 1.6 16V 1.6 16V 1.6 HDi 90 1.6 HDi 90 2.0 HDi 90 2.0 HDi 90	55 65 65 ORGA 10551 50 80 ORGA 09520 80 ORGA 09856 80 ORGA 10551 66 66 ORGA 10551 66 ORGA 09520 66 ORGA 10551	ORGA 09855	08.00 11.03 10.01 04.05	07.07 07.07 - ESP 07.07 + ESP 07.07 07.07 + ESP 07.07 - ESP 07.07 + ESP	BA2214		23599 19,0 /S	BOS
	1.4 16V 1.6 16V 1.6 HDi 110 1.6 HDi 90 2.0 16V 2.0 16V 2.0 HDi 110 2.0 HDi 90 2.0 HDi 90	65 80 80 66 100 103 79 66 ORGA 09520 66 ORGA 10551	ORGA 10550 ORGA 10550	11.03 02.04 04.05 08.00 03.05 08.00	+ ESP 07.07 07.07 + ESP 07.07 07.07 + ESP	BA2229		23600 19,0 /S	BOS
	1.4 1.4 16V 1.4 16V 1.4 HDi 1.6 16V 1.6 16V 1.6 16V 1.6 HDi 90 1.6 HDi 90 2.0 HDi 90 2.0 HDi 90	55 65 65 ORGA 10551 50 80 ORGA 09520 80 ORGA 09856 80 ORGA 10551 66 66 ORGA 10551 66 ORGA 09520 66 ORGA 10551	ORGA 09856	08.00 11.03 10.01 04.05	07.07 07.07 - ESP 07.07 + ESP 07.07 07.07 07.07 + ESP 07.07 - ESP 07.07 + ESP 07.07 - ESP 07.07 + ESP	BAR22194		266 22,0 20,0 V	
	1.4 16V 1.6 16V 1.6 HDi 110 1.6 HDi 90 2.0 16V 2.0 16V 2.0 HDi 110 2.0 HDi 90 2.0 HDi 90	65 80 80 66 100 103 79 66 ORGA 09520 66 ORGA 10551	ORGA 10550 ORGA 10550	11.03 02.04 04.05 08.00 03.05 08.00	+ ESP 07.07 07.07 + ESP 07.07 07.07 + ESP	BAR26120		283 26,0 24,0 V	
	1.4 1.4 16V 1.4 HDi 1.6 16V 1.6 HDi 110 1.6 HDi 90 2.0 16V 2.0 16V 2.0 16V 2.0 HDi 110 2.0 HDi 135 2.0 HDi 90	55 65 50 80 80 66 100 103 130 79 100 66		08.00 11.03 10.01 08.00 02.04 04.05 08.00 03.05 06.05 08.00 10.03 08.00	07.07 07.07 07.07 07.07 07.07 07.07 07.07 07.07 07.07 07.07 07.07 07.07	BA2300 BA2017		24150 17,6 /S 20961 17,2 /S	BOS LUC

1) - ESP/ + manual transm. / - ESP/+ scatola cambio velocità / - ESP/ + transmission mécanique / - ESP/ + cambio de velocidad  
 2) - ⊖ /-ESP/+manual transm. / - ⊖ / -ESP/+ camb.velocità / - ⊖ /-ESP/+transm.mécanique / - ⊖ /-ESP/+ camb.velocidad  
 ⊕ /+ESP/+ manual transm. / + ⊕ /+ESP/+scatola camb.velocità / + ⊕ /+ESP/+transm. mécanique / + ⊕ /+ESP/+cambio velocidad

**PEUGEOT 307 Limousine (00-07)**





















	1.4	55	ORGA 09974	<b>08.00</b>	+ Stahlfelgen <sup>1)</sup>	<b>BAR09137</b>		247 9,0 8,0
	1.4	55	ORGA 09897	<b>08.00</b>	+ Leichtmetallfelgen <sup>2)</sup>			
	1.4	55 ORGA 10885		<b>07.07</b>				
	1.4 HDi	50	ORGA 09974	<b>10.01</b>	+ Stahlfelgen <sup>1)</sup>			
	1.4 HDi	50	ORGA 09897	<b>10.01</b>	+ Leichtmetallfelgen <sup>2)</sup>			
	1.4 HDi	50 ORGA 10885		<b>07.07</b>				
	1.6 16V	80	ORGA 09974	<b>08.00</b>	+ Stahlfelgen <sup>1)</sup>			
	1.6 16V	80	ORGA 09897	<b>08.00</b>	+ Leichtmetallfelgen <sup>2)</sup>			
	1.6 16V	80 ORGA 10885		<b>07.07</b>				
	1.6 HDi 110	80 ORGA 10885		<b>07.07</b>				
	1.6 HDi 90	66 ORGA 10885		<b>07.07</b>				
	2.0 16V	100	ORGA 09974	<b>08.00</b>	+ Stahlfelgen <sup>1)</sup>			
	2.0 16V	100	ORGA 09897	<b>08.00</b>	+ Leichtmetallfelgen <sup>2)</sup>			
	2.0 16V	100 ORGA 10885		<b>07.07</b>				
	2.0 16V	103 ORGA 10885		<b>07.07</b>				
	2.0 16V	130 ORGA 10885		<b>07.07</b>				
	2.0 HDi 110	79	ORGA 09974	<b>08.00</b>	+ Stahlfelgen <sup>1)</sup>			
	2.0 HDi 110	79	ORGA 09897	<b>08.00</b>	+ Leichtmetallfelgen <sup>2)</sup>			
	2.0 HDi 110	79 ORGA 10885		<b>07.07</b>				
2.0 HDi 135	100 ORGA 10885		<b>07.07</b>					
2.0 HDi 90	66	ORGA 09974	<b>08.00</b>	+ Stahlfelgen <sup>1)</sup>				
2.0 HDi 90	66	ORGA 09897	<b>08.00</b>	+ Leichtmetallfelgen <sup>2)</sup>				
2.0 HDi 90	66 ORGA 10885		<b>07.07</b>					

**PEUGEOT 307 Break (02-08)**

	1.4	55	ORGA 10550	<b>04.02</b>	+ ESP	<b>BA2229</b>		23600 19,0 /S	<b>BOS</b>					
	1.4 16V	65	ORGA 10550	<b>11.03</b>	+ ESP									
	1.6 16V	80		<b>03.02</b>	<b>04.08</b>									
	1.6 BioFlex	80		<b>09.07</b>	<b>04.08</b>									
	1.6 HDi 110	80		<b>02.04</b>	<b>04.08</b>									
	1.6 HDi 90	66		<b>04.05</b>	<b>04.08</b>									
	2.0 16V	100		<b>03.02</b>	<b>04.08</b>									
	2.0 16V	103		<b>03.05</b>	<b>04.08</b>									
	2.0 HDi 110	79		<b>03.02</b>	<b>04.08</b>									
	2.0 HDi 90	66 ORGA 09520	ORGA 10550		+ ESP									
	2.0 HDi 90	66		<b>03.02</b>	<b>04.08</b>									
	1.4	55		<b>04.02</b>	<b>09.03</b>	<b>BA2214</b>		23599 19,0 /S	<b>BOS</b>					
	1.4	55 ORGA 10551		<b>04.08</b>	+ ESP									
	1.4 16V	65		<b>11.03</b>	<b>04.08</b>									
	1.4 16V	65 ORGA 10551		<b>04.08</b>	+ ESP									
	1.4 HDi	50		<b>03.02</b>	<b>04.08</b>									
	2.0 HDi 90	66 ORGA 09520		<b>04.08</b>	- ESP									
	2.0 HDi 90	66 ORGA 10551		<b>04.08</b>	+ ESP									
		1.4	55		<b>04.02</b>					<b>09.03</b>	<b>BAR22194</b>		266 22,0 20,0 V	
		1.4	55 ORGA 10551		<b>04.08</b>					+ ESP				
		1.4 16V	65		<b>11.03</b>					<b>04.08</b>				
		1.4 16V	65 ORGA 10551		<b>04.08</b>					+ ESP				
1.4 HDi		50		<b>03.02</b>	<b>04.08</b>									
2.0 HDi 90		66 ORGA 09520		<b>04.08</b>	- ESP									
2.0 HDi 90		66 ORGA 10551		<b>04.08</b>	+ ESP									
		1.4	55	ORGA 10550	<b>04.02</b>	+ ESP	<b>BAR26120</b>		283 26,0 24,0 V					
		1.4 16V	65	ORGA 10550	<b>11.03</b>	+ ESP								
		1.6 16V	80		<b>03.02</b>	<b>04.08</b>								
		1.6 BioFlex	80		<b>09.07</b>	<b>04.08</b>								
	1.6 HDi 110	80		<b>02.04</b>	<b>04.08</b>									
	1.6 HDi 90	66		<b>04.05</b>	<b>04.08</b>									
	2.0 16V	100		<b>03.02</b>	<b>04.08</b>									
	2.0 16V	103		<b>03.05</b>	<b>04.08</b>									
	2.0 HDi 110	79		<b>03.02</b>	<b>04.08</b>									
	2.0 HDi 90	66 ORGA 09520	ORGA 10550		+ ESP									
	2.0 HDi 90	66	ORGA 09519	<b>03.02</b>										
	1.4	55		<b>04.02</b>	<b>09.03</b>	<b>BA2300</b>		24150 17,6 /S	<b>BOS</b>					
	1.4 16V	65		<b>11.03</b>	<b>04.08</b>									
	1.4 HDi	50		<b>03.02</b>	<b>04.08</b>									
	1.6 16V	80		<b>03.02</b>	<b>04.08</b>									
	1.6 HDi 110	80		<b>02.04</b>	<b>04.08</b>									
	1.6 HDi 90	66		<b>04.05</b>	<b>04.08</b>									
	2.0 16V	100		<b>03.02</b>	<b>04.08</b>									
	2.0 16V	103		<b>03.05</b>	<b>04.08</b>									
	2.0 16V	130		<b>06.05</b>	<b>04.08</b>									
	2.0 HDi 110	79		<b>03.02</b>	<b>04.08</b>									
	2.0 HDi 135	100		<b>02.04</b>	<b>04.08</b>									
	2.0 HDi 90	66		<b>03.02</b>	<b>04.08</b>									
		1.4	55	ORGA 09974	<b>04.02</b>					+ Stahlfelgen <sup>1)</sup>	<b>BAR09137</b>		247 9,0 8,0	
		1.4	55	ORGA 09897	<b>04.02</b>					+ Leichtmetallfelgen <sup>2)</sup>				
1.4		55 ORGA 10885		<b>04.08</b>										
1.4 16V		65	ORGA 09974	<b>11.03</b>	+ Stahlfelgen <sup>1)</sup>									
1.4 16V		65	ORGA 09897	<b>11.03</b>	+ Leichtmetallfelgen <sup>2)</sup>									
1.4 16V		65 ORGA 10885		<b>04.08</b>										
1.4 HDi		50	ORGA 09974	<b>03.02</b>	+ Stahlfelgen <sup>1)</sup>									
1.4 HDi		50	ORGA 09897	<b>03.02</b>	+ Leichtmetallfelgen <sup>2)</sup>									
1.4 HDi		50 ORGA 10885		<b>04.08</b>										
1.6 16V		80	ORGA 09974	<b>03.02</b>	+ Stahlfelgen <sup>1)</sup>									
1.6 16V		80	ORGA 09897	<b>03.02</b>	+ Leichtmetallfelgen <sup>2)</sup>									
1.6 16V		80 ORGA 10885		<b>04.08</b>										
2.0 16V		100	ORGA 09974	<b>03.02</b>	+ Stahlfelgen <sup>1)</sup>									
2.0 16V		100	ORGA 09897	<b>03.02</b>	+ Leichtmetallfelgen <sup>2)</sup>									

















<sup>1)</sup> + steel rims / + cerchioni in acciaio / + jantes en acier / + Llantas acero  
<sup>2)</sup> + light alloy rims / + cerchioni in lega / + jantes en alliage léger / + Llantas de aleación ligera



								
<b>PEUGEOT 307 Break (02-08)</b>								
	2.0 16V 2.0 16V 2.0 HDi 110 2.0 HDi 110 2.0 HDi 110 2.0 HDi 90 2.0 HDi 90	103 ORGA 10885 130 ORGA 10885 79 79 79 ORGA 10885 66 66 ORGA 10885	ORGA 09974 ORGA 09897 ORGA 09974 ORGA 09897	03.02 03.02 03.02 03.02	04.08 04.08 + Stahlfelgen <sup>1)</sup> + Leichtmetallfelgen <sup>2)</sup> 04.08 + Stahlfelgen <sup>1)</sup> + Leichtmetallfelgen <sup>2)</sup> 04.08	BAR09137		247 9,0 8,0
<b>PEUGEOT 307 CC (03-09)</b>								
	CC 110 CC 135 CC 140	80 100 103		03.05 10.03 03.05	02.09 02.09 02.09	BA2229		23600 19,0 /S BOS
	CC 110 CC 135 CC 140	80 100 103		03.05 10.03 03.05	02.09 02.09 02.09	BAR26120		283 26,0 24,0 V
	CC 135 CC 180	100 130		10.03 10.03	02.09 02.09	BA2017		20961 17,2 /S LUC
	CC 110 CC 140 CC HDi 135	80 103 100		03.05 03.05 06.05	02.09 02.09 02.09	BA2300 BA2017		24150 17,6 /S BOS 20961 17,2 /S LUC
	CC 110 CC 135 CC 135 CC 135 CC 140 CC 180 CC 180 CC 180 CC HDi 135	80 ORGA 10885 100 100 100 ORGA 10885 103 ORGA 10885 130 130 130 ORGA 10885 100 ORGA 10885	ORGA 09974 ORGA 09897 ORGA 09974 ORGA 09897	10.03 10.03 10.03 10.03	02.09 + Stahlfelgen <sup>1)</sup> + Leichtmetallfelgen <sup>2)</sup> 02.09 02.09 + Stahlfelgen <sup>1)</sup> + Leichtmetallfelgen <sup>2)</sup> 02.09 02.09	BAR09137		247 9,0 8,0
<b>PEUGEOT 307 SW (02-08)</b>								
	1.4 1.4 1.4 16V 1.4 16V 2.0 HDi 90 2.0 HDi 90	55 55 ORGA 10551 65 65 ORGA 10551 66 ORGA 09520 66 ORGA 10551		04.02 11.03	04.08 - ESP 04.08 + ESP 04.08 - ESP 04.08 + ESP 04.08 - ESP 04.08 + ESP	BA2214		23599 19,0 /S BOS
	1.4 1.4 16V 1.6 16V 1.6 BioFlex 1.6 D 1.6 HDi 110 2.0 16V 2.0 16V 2.0 HDi 110 2.0 HDi 90 2.0 HDi 90	55 65 80 80 66 80 100 103 79 66 ORGA 09520 66	ORGA 10550 ORGA 10550	04.02 11.03 03.02 09.07 12.06 02.04 03.02 03.05 03.02 03.02	+ ESP + ESP 04.08 04.08 04.08 04.08 04.08 04.08 04.08 + ESP	BA2229		23600 19,0 /S BOS
	1.4 1.4 1.4 16V 1.4 16V 2.0 HDi 90 2.0 HDi 90	55 55 65 65 ORGA 10551 66 ORGA 09520 66 ORGA 10551	ORGA 10551	04.02 11.03	04.08 + ESP 04.08 - ESP 04.08 - ESP 04.08 + ESP 04.08 - ESP 04.08 + ESP	BAR22194		266 22,0 20,0 V
	1.4 1.4 16V 1.6 16V 1.6 BioFlex 1.6 D 1.6 HDi 110 2.0 16V 2.0 16V 2.0 HDi 110 2.0 HDi 90 2.0 HDi 90	55 65 80 80 66 80 100 103 79 66 ORGA 09520 66	ORGA 10550 ORGA 10550	04.02 11.03 03.02 09.07 12.06 02.04 03.02 03.05 03.02 03.02	+ ESP + ESP 04.08 04.08 04.08 04.08 04.08 04.08 04.08 + ESP	BAR26120		283 26,0 24,0 V
	1.4 1.4 16V 1.6 16V 1.6 BioFlex 1.6 D 1.6 HDi 110 2.0 16V 2.0 16V 2.0 HDi 110 2.0 HDi 135 2.0 HDi 90	55 65 80 80 66 80 100 103 79 100 66		04.02 11.03 03.02 09.07 12.06 02.04 03.02 03.05 03.02 02.04 03.02	09.03 04.08 04.08 04.08 04.08 04.08 04.08 04.08 04.08 04.08 04.08	BA2300 BA2017		24150 17,6 /S BOS 20961 17,2 /S LUC
	1.4 1.4 1.4 1.4 16V 1.4 16V 1.4 16V 1.6 16V 1.6 16V 1.6 16V	55 55 55 ORGA 10885 65 65 65 ORGA 10885 80 80 80 ORGA 10885	ORGA 09974 ORGA 09897 ORGA 09974 ORGA 09897 ORGA 09974 ORGA 09897	04.02 04.02 11.03 11.03 03.02 03.02	+ Stahlfelgen <sup>1)</sup> + Leichtmetallfelgen <sup>2)</sup> 04.08 + Stahlfelgen <sup>1)</sup> + Leichtmetallfelgen <sup>2)</sup> 04.08 + Stahlfelgen <sup>1)</sup> + Leichtmetallfelgen <sup>2)</sup> 04.08	BAR09137		247 9,0 8,0

















<sup>1)</sup> + steel rims / + cerchioni in acciaio / + jantes en acier / + Llantas acero















<sup>2)</sup> + light alloy rims / + cerchioni in lega / + jantes en alliage léger / + Llantas de aleación ligera





















								
<b>PEUGEOT 307 SW (02-08)</b>								
	1.6 BioFlex	80	ORGA 09974	09.07	+ Stahlfelgen <sup>1)</sup>	BAR09137		247 9,0 8,0
	1.6 BioFlex	80	ORGA 09897	09.07	+ Leichtmetallfelgen <sup>2)</sup>			
	1.6 BioFlex	80	ORGA 10885	04.08				
	1.6 D	66	ORGA 09974	12.06	+ Stahlfelgen <sup>1)</sup>			
	1.6 D	66	ORGA 09897	12.06	+ Leichtmetallfelgen <sup>2)</sup>			
	1.6 D	66	ORGA 10885	04.08				
	1.6 HDi 110	80	ORGA 10885	04.08				
	2.0 16V	100	ORGA 09974	03.02	+ Stahlfelgen <sup>1)</sup>			
	2.0 16V	100	ORGA 09897	03.02	+ Leichtmetallfelgen <sup>2)</sup>			
	2.0 16V	100	ORGA 10885	04.08				
	2.0 16V	103	ORGA 10885	04.08				
	2.0 HDi 110	79	ORGA 09974	03.02	+ Stahlfelgen <sup>1)</sup>			
	2.0 HDi 110	79	ORGA 09897	03.02	+ Leichtmetallfelgen <sup>2)</sup>			
	2.0 HDi 110	79	ORGA 10885	04.08				
	2.0 HDi 135	100	ORGA 10885	04.08				
	2.0 HDi 90	66	ORGA 09974	03.02	+ Stahlfelgen <sup>1)</sup>			
	2.0 HDi 90	66	ORGA 09897	03.02	+ Leichtmetallfelgen <sup>2)</sup>			
	2.0 HDi 90	66	ORGA 10885	04.08				
<b>PEUGEOT 308 Limousine (07-)</b>								
	1.4 16V	72		12.09		BAR26120		283 26,0 24,0 V
	1.4 VTi	70		08.07				
	1.6 140 THP	103		08.07				
	1.6 150 THP	110		08.07				
	1.6 BioFlex	80		04.08				
	1.6 HDi 110	80		08.07				
	1.6 HDi 90	66		08.07				
	1.6 VTi	88		08.07				
	2.0 HDi 135	100		08.07				
	2.0 HDi 135	100		08.07				
<b>PEUGEOT 308 SW (08-)</b>								
	1.4 16V	70		05.08		BAR26120		283 26,0 24,0 V
	1.4 16V	72		12.09				
	1.6 16V			05.08				
	1.6 Bioflex	82		03.09				
	1.6 HDi			05.08				
	1.6 HDi	80		05.08				
<b>PEUGEOT 308 CC (09-)</b>								
	1.6 HDi	82		03.09		BAR26120		283 26,0 24,0 V
	1.6 VTi	88		03.09				
<b>PEUGEOT 308 (09-)</b>								
	1.6 HDi	80		06.09		BAR26120		283 26,0 24,0 V
	1.6 HDi	82		08.10				
	1.6 VTi	88		06.09				
<b>PEUGEOT 309 (85-93)</b>								
	1.1			09.85	12.93	BA2055 BA2036		20905 18,0 +/WK 20989 17,5 +/WK
	1.3	47		09.85	07.89			
	1.4			03.89	12.93			
	1.5			06.87	12.89			
	1.6			09.85	12.93			
	1.8 D	44		07.89	12.93			
	1.8 TD	57		07.89	12.93			
	1.9	72		03.86	12.93			
	1.9	75		10.85	07.89			
	1.9	80		07.88	12.93			
	1.9 D			06.86	12.93			
	1.6 GTi	76		11.85	09.88			
	1.9 GTi	88		09.88	12.93 + ⊕			
	1.9 GTi	94		10.86	07.89 + ⊕			
	1.9 GTi	96		10.86	12.93 - ⊕			
	1.9 GTi 16V			08.89	12.93			
	1.1			09.85	12.93	BAR10187		247 10,0 8,0
	1.3	47		09.85	07.89			
	1.4			03.89	12.93			
	1.5			06.87	12.89			
	1.6			09.85	12.93			
	1.8 D	44		07.89	12.93			
	1.8 TD	57		07.89	12.93			
	1.9	72		03.86	12.93			
	1.9	75		10.85	07.89			
	1.9	80		07.88	12.93			
	1.9 D			06.86	12.93			
	1.6 GTi	76		11.85	09.88			
	1.9 GTi	88		09.88	12.93 + ⊕			
	1.9 GTi	94		10.86	07.89 + ⊕			
	1.9 GTi	96		10.86	12.93 - ⊕			
	1.9 GTi 16V			08.89	12.93			
	1.9 GTi	88		09.88	12.93 + ⊕	BA2076		20973 11,0 +
	1.9 GTi	94		10.86	07.89 + ⊕			
	1.9 GTi	96		10.86	12.93 - ⊕			
	1.9 GTi 16V			08.89	12.93			

























<sup>1)</sup> + steel rims / + cerchioni in acciaio / + jantes en acier / + Llantas acero

<sup>2)</sup> + light alloy rims / + cerchioni in lega / + jantes en alliage léger / + Llantas de aleación ligera













								
<b>PEUGEOT 309 (85-93)</b>								
	1.1 1.4 1.5		09.89 03.89 09.89	12.93 12.93 12.89	BAE5020			180 x 32 AUT <b>BDX</b>
<b>PEUGEOT 405 (93-95)</b>								
	1.4 i 1.6	55 65	09.92 09.92	10.95 10.95	BA2055			20905 18,0 +/-WK <b>BDX</b>
	1.6 1.8 i 1.9 1.9 D 1.9 TD 2.0 16V 2.0 i 2.0 i X4	65 74 93 66 144 89 89	09.92 09.92 09.92 09.92 09.92 09.92 09.92	10.95 10.95 12.93 10.95 10.95 10.95 10.95	BA2043			21209 18,5 +/-WK/S <b>LUC</b>
	1.8 i 1.9 1.9 D 1.9 TD 2.0 16V 2.0 i 2.0 i X4	74 93 66 144 89 89	09.92 09.92 09.92 09.92 09.92 09.92	10.95 12.93 10.95 10.95 10.95 10.95	BAR20133			266 20,5 18,5 V
	2.0 i X4 2.0 T16 X4	89 144	09.92 07.93	10.95 10.95	BA2032			20961 15,2 /S <b>LUC</b>
	2.0 i X4 2.0 T16 X4	89 144	09.92 07.93	10.95 10.95	BAR10187			247 10,0 8,0
<b>PEUGEOT 406 Limousine (95-04)</b>								
	1.6 i 1.8 16V 1.8 16V 1.8 i 1.9 D	65 81 85 66 55	10.95 10.95 10.00 05.97 10.96	04.04 10.00 04.04 04.04 04.04	BA2015			21724 18,2 +/-WK/S <b>LUC</b>
	1.9 TD 1.9 TD 2.0 16V 2.0 16V 2.0 16V 2.0 16V 2.0 16V HPi 2.0 HDi 110 2.0 HDi 110 FAP 2.0 HDi 90 2.0 Turbo 2.1 TD 2.2 HDi 2.2 i 3.0 24V 3.0 V6	66 68 97 99 100 103 80 79 66 108 80 98 116 140 152	01.96 01.96 10.95 01.99 08.00 05.01 02.99 08.01 02.99 04.96 10.95 03.00 07.00 10.96 03.00	04.04 04.04 04.04 08.00 04.04 04.04 08.01 04.04 04.04 04.04 04.04 04.04 04.04 04.04 04.04 04.04	BA2016			21674 19,3 /WK/S <b>LUC</b>
	1.6 i 1.8 16V 1.8 16V 1.8 i 1.9 D	65 81 85 66 55	10.95 10.95 10.00 05.97 10.96	04.04 10.00 04.04 04.04 04.04	BAR24139			260 24,0 22,0 V
	1.9 TD 1.9 TD 2.0 16V 2.0 16V 2.0 16V 2.0 16V 2.0 16V HPi 2.0 HDi 110 2.0 HDi 110 FAP 2.0 HDi 90 2.0 Turbo 2.1 TD 2.2 HDi 2.2 i 3.0 24V 3.0 V6	66 68 97 99 100 103 80 79 66 108 80 98 116 140 152	01.96 01.96 10.95 01.99 08.00 05.01 02.99 08.01 02.99 04.96 10.95 03.00 07.00 10.96 03.00	04.04 04.04 04.04 08.00 04.04 04.04 08.01 04.04 04.04 04.04 04.04 04.04 04.04 04.04 04.04 04.04	BAR26106			283 26,0 24,2 V
	1.8 16V 2.0 16V 2.0 16V 2.0 16V 2.0 16V HPi 2.0 HDi 110 2.0 HDi 110 FAP 2.0 HDi 90 2.0 Turbo 2.1 TD 2.2 HDi 2.2 i 3.0 24V 3.0 V6	85 97 99 100 103 80 79 66 108 80 98 116 140 152	S 80012040 S 80012040 S 80012040 S 80012040 S 80012040 S 80012040 S 80012040 S 80012040 S 80012040 S 80012040 S 80012040 S 80012040 S 80012040 S 80012040	10.00 10.95 01.99 08.00 05.01 02.99 08.01 02.99 04.96 10.95 03.00 07.00 10.96 03.00	08.00 08.01	BA2099		21278 17,0 +/-WK <b>ATE</b>

									
<b>PEUGEOT 406 Limousine (95-04)</b>									
	1.8 16V	85		10.00	04.04		BAR10230		291 10,0 8,0
	2.0 16V	97		10.95	04.04				
	2.0 16V	99		01.99	08.00				
	2.0 16V	100		08.00	04.04				
	2.0 16V HPi	103		05.01	04.04				
	2.0 HDi 110	80		02.99	08.01				
	2.0 HDi 110 FAP	79		08.01	04.04				
	2.0 HDi 90	66		02.99	04.04				
	2.0 Turbo	108		04.96	04.04				
	2.1 TD	80		10.95	04.04				
	2.2 HDi	98		03.00	04.04				
	2.2 i	116		07.00	04.04				
	3.0 24V	140		10.96	04.04				
	3.0 V6	152		03.00	04.04				
<b>PEUGEOT 406 Kombi (96-04)</b>									
	1.8	66		05.97	04.04		BA2015		21724 18,2 +/WK/S LUC
	1.8 16V	81		10.95	10.00				
	1.8 16V	85		10.96	04.04				
	1.9 D	55		10.96	04.04				
	1.9 TD	66		10.95	04.04		BA2016		21674 19,3 /WK/S LUC
	2.0 16V	97		10.96	04.04				
	2.0 16V	99		01.99	10.00				
	2.0 16V	100		10.00	04.04				
	2.0 16V HPi	103		05.01	04.04				
	2.0 HDi 110	80		02.99	08.01				
	2.0 HDi 110 FAP	79		08.01	04.04				
	2.0 HDi 90	66		02.99	04.04				
	2.0 Turbo	108		10.96	04.04				
	2.1 TD	80		10.96	04.04				
	2.2	116		07.00	04.04				
	2.2 HDi	98		03.00	04.04				
	3.0 24V	140		10.96	04.04				
	3.0 V6	152		03.00	04.04				
	1.8	66		05.97	04.04		BAR24139		260 24,0 22,0 V
	1.8 16V	81		10.95	10.00				
	1.8 16V	85		10.96	04.04				
	1.9 D	55		10.96	04.04				
	1.9 TD	66		10.95	04.04		BAR26106		283 26,0 24,2 V
	2.0 16V	97		10.96	04.04				
	2.0 16V	99		01.99	10.00				
	2.0 16V	100		10.00	04.04				
	2.0 16V HPi	103		05.01	04.04				
	2.0 HDi 110	80		02.99	08.01				
	2.0 HDi 110 FAP	79		08.01	04.04				
	2.0 HDi 90	66		02.99	04.04				
	2.0 Turbo	108		10.96	04.04				
	2.1 TD	80		10.96	04.04				
	2.2	116		07.00	04.04				
	2.2 HDi	98		03.00	04.04				
	3.0 24V	140		10.96	04.04				
	3.0 V6	152		03.00	04.04				
	1.8 16V	85	S 80012040	10.00			BA2099		21278 17,0 +/WK ATE
	2.0 16V	97	S 80012040	10.96					
	2.0 16V	99		01.99	10.00				
	2.0 16V	100	S 80012040	10.00					
	2.0 16V HPi	103	S 80012040	05.01					
	2.0 HDi 110	80		02.99	08.01				
	2.0 HDi 110 FAP	79	S 80012040	08.01					
	2.0 HDi 90	66	S 80012040	02.99					
	2.0 Turbo	108	S 80012040	10.96					
	2.1 TD	80	S 80012040	10.96					
	2.2	116	S 80012040	07.00					
	2.2 HDi	98	S 80012040	03.00					
	3.0 24V	140	S 80012040	10.96					
	3.0 V6	152	S 80012040	03.00					
	1.8 16V	85		10.00	04.04		BAR10230		291 10,0 8,0
	2.0 16V	97		10.96	04.04				
	2.0 16V	99		01.99	10.00				
	2.0 16V	100		10.00	04.04				
	2.0 16V HPi	103		05.01	04.04				
	2.0 HDi 110	80		02.99	08.01				
	2.0 HDi 110 FAP	79		08.01	04.04				
	2.0 HDi 90	66		02.99	04.04				
	2.0 Turbo	108		10.96	04.04				
	2.1 TD	80		10.96	04.04				
	2.2	116		07.00	04.04				
	2.2 HDi	98		03.00	04.04				
	3.0 24V	140		10.96	04.04				
	3.0 V6	152		03.00	04.04				
<b>PEUGEOT 406 Coupe (97-05)</b>									
	2.0 16V	97		03.97	09.05		BA2016		21674 19,3 /WK/S LUC
	2.0 16V	99		01.99	10.00				
	2.0 16V	100		10.00	09.05				
	2.2	116		03.02	09.05				
	2.2 HDi	98		06.02	09.05				

	   kW							
<b>PEUGEOT 406 Coupe (97-05)</b>								
	2.0 16V 2.0 16V 2.0 16V 2.2 2.2 HDi	97 99 100 116 98		03.97 01.99 10.00 03.02 06.02	09.05 10.00 09.05 09.05 09.05	BAR26106		283 26,0 24,2 V
	2.0 16V 2.0 16V 2.0 16V 2.2 2.2 HDi 3.0 24V 3.0 V6	97 99 100 116 98 140 152	S 80012040 S 80012040 S 80012040 S 80012040 S 80012040 S 80012040 S 80012040	03.97 01.99 10.00 03.02 03.00 03.97 03.00	09.05 10.00	BA2099		21278 17,0 +/WK ATE
	2.0 16V 2.0 16V 2.0 16V 2.2 2.2 HDi 3.0 24V 3.0 V6	97 99 100 116 98 140 152		03.97 01.99 10.00 03.02 03.00 03.97 03.00	09.05 10.00 09.05 09.05 09.05 09.05 09.05	BAR10230		291 10,0 8,0
<b>PEUGEOT 806 (94-02)</b>								
	1.8 i 1.9 TD 2.0 16V 2.0 HDi 2.0 i 2.0 Turbo 2.1 TD	73		10.96 07.95 10.98 08.99 08.94 08.94 06.96	06.02 06.02 06.02 06.02 06.02 06.02 06.02	BA2079 BA2047		23042 18,7 /WK BDX 21801 19,0 +/WK/S LUC
	1.8 i 1.9 TD 2.0 16V 2.0 HDi 2.0 i 2.0 Turbo 2.1 TD	73		10.96 07.95 10.98 08.99 08.94 08.94 06.96	06.02 06.02 06.02 06.02 06.02 06.02 06.02	BAR20155 BAR26104		258 20,0 18,2 V L 281 26,0 24,2 V
	1.8 i 1.9 TD 2.0 HDi 2.0 i	73		10.96 07.95 08.99 08.94	06.02 - ABS 06.02 - ABS 06.02 - ABS 06.02 - ABS	BAW1906		Rz 19,05
	1.8 i 1.9 TD 2.0 HDi 2.0 i	73		10.96 07.95 08.99 08.94	06.02 - ABS 06.02 - ABS 06.02 - ABS 06.02 - ABS	BAE5037		255 x 61
<b>PEUGEOT 807 (02-)</b>								
	2.0 16V 2.0 16V 2.0 HDi 2.0 HDi 2.0 HDi 2.0 HDi 2.2 16V 2.2 HDi	100 103 79 80 88 100 116 94		06.02 09.05 06.02 04.04 11.06 06.06 06.02 06.02	05.06	BA2285		20261 19,3 +/WK/S LUC
	2.0 16V 2.0 16V 2.0 HDi 2.0 HDi 2.0 HDi 2.0 HDi 2.2 16V 2.2 HDi 2.2 HDi	100 103 79 80 88 100 116 94 125		06.02 09.05 06.02 04.04 11.06 06.06 06.02 06.02 10.07	05.06	BAR28136		285 28,0 26,0 V
	2.0 16V 2.0 16V 2.0 HDi 2.0 HDi 2.0 HDi 2.0 HDi 2.2 16V 2.2 HDi 2.2 HDi 3.0 V6	100 103 79 80 88 100 116 94 125 150		06.02 09.05 06.02 04.04 11.06 06.06 06.02 06.02 10.07 06.02	05.06	BA2017		20961 17,2 /S LUC
<b>PEUGEOT 1007 (05-)</b>								
	1.4 1.4 16V 1.4 HDi 1.6 16V 1.6 HDi 110	54 65 50 80 80		04.05 10.05 04.05 04.05 04.07		BA2214 BA2229		23599 19,0 /S BOS 23600 19,0 /S BOS
	1.4 1.4 16V 1.4 HDi 1.6 16V 1.6 HDi 110	54 65 50 80 80		04.05 10.05 04.05 04.05 04.07		BAR22194 BAR26120		266 22,0 20,0 V 283 26,0 24,0 V

								
<b>PEUGEOT 1007 (05-)</b>								
	1.6 16V 1.6 HDi 110	80 80	04.05 04.07		BA2017			20961 17,2 /S LUC
	1.6 16V 1.6 HDi 110	80 80	04.05 04.07		BAR09137			247 9,0 8,0
<b>PEUGEOT 4007 (07-)</b>								
	2.0 2.0 4x4 2.2 HDi 4x4 2.4 16V 4x4	108 108 115 125	11.10 11.10 02.07 07.07		BA2249			21363 16,0 +/-WK AKE
<b>PEUGEOT 5008 (09-)</b>								
	1.6 16V 1.6 HDi 1.6 HDi	88 80 82	09.09 09.09 08.10		BAR26120			283 26,0 24,0 V
<b>PEUGEOT BIPPER (08-)</b>								
	1.3 HDi 75 1.4 HDi 1.4 i	55 50 54	10.10 02.08 02.08	+ Automatikgetriebe <sup>1)</sup>	BAR22197			258 22,0 20,2 V
<b>PEUGEOT BOXER Bus (94-02)</b>								
	1.9 D (10) 1.9 TD (10/14) 1.9 TD (10/14) 2.0 i (10/14) 2.5 D (14) 2.5 TD (14) 2.5 TDi (14)	51 66 68 80 63 76 79	02.94 08.94 02.94 02.94 08.94 08.94 01.97	12.99 12.99 12.99 12.99 12.99 12.99 12.99	BA2045			21797 19,7 +/-WK/S LUC
	1.9 D (10) 1.9 TD (10/14) 1.9 TD (10/14) 2.0 i (10/14) 2.5 D (14) 2.5 TD (14) 2.5 TDi (14) 2.8 HDi (14)	51 66 68 80 63 76 79 94	01.00 01.00 01.00 01.00 01.00 01.00 01.00 11.00	10.01 10.01 10.01 10.01 10.01 10.01 10.01 10.01	BA2325			23602 19,7 +/-WK/S LUC
	1.9 D (10) 1.9 TD (10/14) 1.9 TD (10/14) 2.0 i (10/14) 2.5 D (14) 2.5 TD (14) 2.5 TDi (14) 2.8 HDi (14)	51 66 68 80 63 76 79 94	11.01 11.01 11.01 11.01 11.01 11.01 11.01 11.01	03.02 03.02 03.02 03.02 03.02 03.02 03.02 03.02	BA2241			23917 19,0 +/-WK/Zub BRE
	2.0 i (18) 2.5 D (18) 2.5 TD (18) 2.5 TDi (18)	80 63 76 79	02.94 08.94 08.94 01.97	12.99 12.99 12.99 12.99	BA2046			21799 19,7 +/-WK/S LUC
	2.0 i (18) 2.5 D (18) 2.5 TD (18) 2.5 TDi (18) 2.8 HDi (18)	80 63 76 79 94	11.01 11.01 11.01 11.01 11.01	03.02 03.02 03.02 03.02 03.02	BA2324			23919 18,3 +/-WK/Zub BRE
	1.9 D (10) 1.9 TD (10/14) 1.9 TD (10/14) 2.0 i (10/14) 2.5 D (14) 2.5 TD (14) 2.5 TDi (14) 2.8 HDi (14)	51 66 68 80 63 76 79 94	02.94 08.94 02.94 02.94 08.94 08.94 01.97 11.00	03.02 03.02 03.02 03.02 03.02 03.02 03.02 03.02	BAR18108			280 18,0 15,9
	2.5 TD (14) 2.5 TDi (14) 2.8 HDi (14)	76 79 94	08.94 01.97 11.00	10.01 03.02 03.02	BAR24127			280 24,0 21,9 V
	2.0 i (18) 2.5 D (18) 2.5 TD (18) 2.5 TDi (18)	80 63 76 79	02.94 08.94 08.94 01.97	03.02 03.02 03.02 03.02	BAR24138			300 24,0 21,9 V
	1.9 D (10) 1.9 TD (10/14) 1.9 TD (10/14) 2.0 i (10/14/18) 2.5 D (14/18) 2.5 TD (14/18) 2.5 TDi (14/18) 2.8 HDi (14/18)	51 66 68 80 63 76 79 94	11.01 11.01 11.01 11.01 11.01 11.01 11.01 11.01	03.02 03.02 03.02 03.02 03.02 03.02 03.02 03.02	BA2323			23921 20,0 /Zub BRE
	2.5 TD (14) 2.5 TDi (14) 2.8 HDi (14)	76 79 94	08.94 01.97 11.00	10.01 10.01 10.01	BAW2600			Rz 26,99
	1.9 D (10) 1.9 TD (10/14) 1.9 TD (10/14) 2.0 i (10/14) 2.5 D (14) 2.5 TD (14)	51 66 68 80 63 76	11.01 11.01 11.01 11.01 11.01 11.01	03.02 03.02 03.02 03.02 03.02 03.02	BAW2600			Rz 26,99

<sup>1)</sup> + autom.transmission / + scatola cambio automatico / + transmission automatique / + cambio automático

	 kW							
<b>PEUGEOT BOXER Bus (94-02)</b>								
	2.5 TDi (14)	79		11.01	03.02			Rz 26,99
	2.8 HDi (14)	94		11.01	03.02			
	2.0 i (18)	80		02.94	10.01			Rz 28,57
	2.5 D (18)	63		08.94	10.01			
	2.5 TD (18)	76		08.94	10.01			
	2.5 TDi (18)	79		01.97	10.01			
	2.8 HDi (18)	94		11.00	10.01			
	1.9 D (10)	51		02.94	10.01			254 x 57 HEB LUC
	1.9 TD (10/14)	66		08.94	10.01			
	1.9 TD (10/14)	68		02.94	10.01			
	2.0 i (10/14)	80		02.94	10.01			
	2.5 D (14)	63		08.94	10.01			
	2.5 TD (14)	76		08.94	10.01			
	2.5 TDi (14)	79		01.97	10.01			
	2.8 HDi (14)	94		11.00	10.01			
	1.9 D (10)	51		11.01	03.02		- Quick Fit	254 x 57 HEB AP
	1.9 TD (10/14)	66		11.01	03.02			
1.9 TD (10/14)	68		11.01	03.02				
2.0 i (10/14)	80		11.01	03.02				
2.5 D (14)	63		11.01	03.02				
2.5 TD (14)	76		11.01	03.02				
2.5 TDi (14)	79		11.01	03.02				
2.8 HDi (14)	94		11.01	03.02				
2.0 i (18)	80		02.94	10.01			254 x 57 HEB LUC	
2.5 D (18)	63		08.94	10.01				
2.5 TD (18)	76		08.94	10.01				
2.5 TDi (18)	79		01.97	10.01				
2.8 HDi (18)	94		11.00	10.01				
<b>PEUGEOT BOXER Kasten (94-02)</b>								
	1.9 D (10)	50		07.99	12.99			21797 19,7 +/-WK/S LUC
	1.9 D (10)	51		02.94	12.99			
	1.9 TD (10/14)	66		07.99	12.99			
	1.9 TD (10/14)	68		02.94	12.99			
	2.0 i (10/14)	80		02.94	12.99			
	2.5 D (14)	63		02.94	12.99			
	2.5 TD (14)	76		02.94	12.99			
	2.5 TDi (14)	79		01.97	12.99			
	1.9 D (10)	50		01.00	10.01			23602 19,7 +/-WK/S LUC
	1.9 D (10)	51		01.00	10.01			
1.9 TD (10/14)	66		01.00	10.01				
1.9 TD (10/14)	68		01.00	10.01				
2.0 HDi (10/14)	62		08.01	10.01				
2.0 i (10/14)	80		01.00	10.01				
2.5 D (14)	63		01.00	10.01				
2.5 TD (14)	76		01.00	10.01				
2.5 TDi (14)	79		01.00	10.01				
2.8 HDi (14)	94		11.00	10.01				
1.9 D (10)	50		11.01	03.02			23917 19,0 +/-WK/Zub BRE	
1.9 D (10)	51		11.01	03.02				
1.9 TD (10/14)	66		11.01	03.02				
1.9 TD (10/14)	68		11.01	03.02				
2.0 HDi (10/14)	62		11.01	03.02				
2.0 i (10/14)	80		11.01	03.02				
2.5 D (14)	63		11.01	03.02				
2.5 TD (14)	76		11.01	03.02				
2.5 TDi (14)	79		11.01	03.02				
2.8 HDi (14)	94		11.01	03.02				
2.0 i (18)	80		02.94	12.99			21799 19,7 +/-WK/S LUC	
2.5 D (18)	63		02.94	12.99				
2.5 TD (18)	76		02.94	12.99				
2.5 TDi (18)	79		01.97	12.99				
2.0 i (18)	80		11.01	03.02			23919 18,3 +/-WK/Zub BRE	
2.5 D (18)	63		11.01	03.02				
2.5 TD (18)	76		11.01	03.02				
2.5 TDi (18)	79		11.01	03.02				
2.8 HDi (18)	94		11.01	03.02				
	1.9 D (10)	50		07.99	03.02			280 18,0 15,9
	1.9 D (10)	51		02.94	03.02			
	1.9 TD (10/14)	66		07.99	03.02			
	1.9 TD (10/14)	68		02.94	03.02			
	2.0 i (10/14)	80		02.94	03.02			
	2.5 D (14)	63		02.94	03.02			
2.5 TD (14)	76		02.94	03.02			280 24,0 21,9 V	
2.5 TDi (14)	79		01.97	03.02				
2.8 HDi (14)	94		11.00	03.02				
2.0 HDi (18)	62		08.01	03.02			300 24,0 21,9 V	
2.0 i (18)	80		02.94	03.02				
2.5 D (18)	63		02.94	03.02				
2.5 TD (18)	76		02.94	03.02				
2.5 TDi (18)	79		01.97	03.02				
2.8 HDi (18)	94		11.00	03.02				

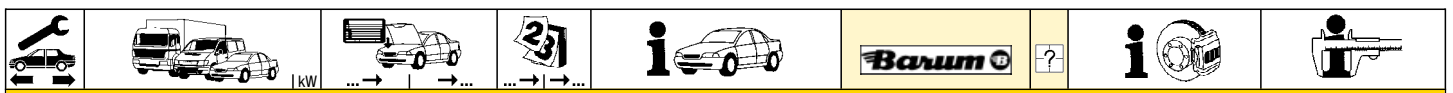

**PEUGEOT BOXER Kasten (94-02)**

	1.9 D (10)	50		11.01	03.02	BA2323		23921 20,0 /Zub	BRE
	1.9 D (10)	51		11.01	03.02				
	1.9 TD (10/14)	66		11.01	03.02				
	1.9 TD (10/14)	68		11.01	03.02				
	2.0 HDi (10/14/18)	62		11.01	03.02				
	2.0 i (10/14/18)	80		11.01	03.02				
	2.5 D (14/18)	63		11.01	03.02				
	2.5 TDi (14/18)	79		11.01	03.02				
	2.5 TDi (14/18)	79		11.01	03.02				
2.8 HDi (14/18)	79		11.01	03.02					
	2.5 TD (14)	76		02.94	10.01	BAW2600		Rz 26,99	
	2.5 TDi (14)	79		01.97	10.01				
	2.8 HDi (14)	94		11.00	10.01				
	1.9 D (10)	50		11.01	03.02	BAW2600		Rz 26,99	
	1.9 D (10)	51		11.01	03.02				
	1.9 TD (10/14)	66		11.01	03.02				
	1.9 TD (10/14)	68		11.01	03.02				
	2.0 HDi (10/14)	62		11.01	03.02				
	2.0 i (10/14)	80		11.01	03.02				
	2.5 D (14)	63		11.01	03.02				
	2.5 TD (14)	76		11.01	03.02				
	2.5 TDi (14)	79		11.01	03.02				
	2.8 HDi (14)	94		11.01	03.02				
	2.0 HDi (18)	62		08.01	10.01	BAW2800		Rz 28,57	
	2.0 i (18)	80		02.94	10.01				
2.5 D (18)	63		02.94	10.01					
2.5 TD (18)	76		02.94	10.01					
2.5 TDi (18)	79		01.97	10.01					
2.8 HDi (18)	94		11.00	10.01					
	1.9 D (10)	50		07.99	10.01	BAE5023		254 x 57 HEB	LUC
	1.9 D (10)	51		02.94	10.01				
	1.9 TD (10/14)	66		07.99	10.01				
	1.9 TD (10/14)	68		02.94	10.01				
	2.0 HDi (10/14)	62		08.01	10.01				
	2.0 i (10/14)	80		02.94	10.01				
	2.5 D (14)	63		02.94	10.01				
	2.5 TD (14)	76		02.94	10.01				
	2.5 TDi (14)	79		01.97	10.01				
	2.8 HDi (14)	94		11.00	10.01				
	1.9 D (10)	50		11.01	03.02	BAE5032	- Quick Fit	254 x 57 HEB	AP
	1.9 D (10)	51		11.01	03.02				
	1.9 TD (10/14)	66		11.01	03.02				
	1.9 TD (10/14)	68		11.01	03.02				
	2.0 HDi (10/14)	62		11.01	03.02				
2.0 i (10/14)	80		11.01	03.02					
2.5 D (14)	63		11.01	03.02					
2.5 TD (14)	76		11.01	03.02					
2.5 TDi (14)	79		11.01	03.02					
2.8 HDi (14)	94		11.01	03.02					
2.0 HDi (18)	62		08.01	10.01	BAE5042		254 x 57 HEB	LUC	
2.0 i (18)	80		02.94	10.01					
2.5 D (18)	63		02.94	10.01					
2.5 TD (18)	76		02.94	10.01					
2.5 TDi (18)	79		01.97	10.01					
2.8 HDi (18)	94		11.00	10.01					

**PEUGEOT BOXER Pritsche/Fahrgestell (94-02)**

	1.9 TD (10/14)	66		12.98	12.99	BA2045		21797 19,7 +/-WK/S	LUC
	1.9 TD (10/14)	68		07.96	12.99				
	2.0 i (10/14)	80		06.94	12.99				
	2.5 D (14)	63		02.94	12.99				
	2.5 TD (14)	76		02.94	12.99				
	2.5 TDi (14)	79		01.97	12.99				
	1.9 TD (10/14)	66		01.00	10.01				
1.9 TD (10/14)	68		01.00	10.01					
2.0 i (10/14)	80		01.00	10.01					
2.5 D (14)	63		01.00	10.01					
2.5 TD (14)	76		01.00	10.01					
2.5 TDi (14)	79		01.00	10.01					
2.8 HDi (14)	94		11.00	10.01					
1.9 TD (10/14)	66		11.01	03.02	BA2241		23917 19,0 +/-WK/Zub	BRE	
1.9 TD (10/14)	68		11.01	03.02					
2.0 i (10/14)	80		11.01	03.02					
2.5 D (14)	63		11.01	03.02					
2.5 TD (14)	76		11.01	03.02					
2.5 TDi (14)	79		11.01	03.02					
2.8 HDi (14)	94		11.01	03.02					
2.0 i (18)	80		06.94	12.99	BA2046		21799 19,7 +/-WK/S	LUC	
2.5 D (18)	63		02.94	12.99					
2.5 TD (18)	76		02.94	12.99					
2.5 TDi (18)	79		01.97	12.99					
2.0 i (18)	80		11.01	03.02	BA2324		23919 18,3 +/-WK/Zub	BRE	
2.5 D (18)	63		11.01	03.02					
2.5 TD (18)	76		11.01	03.02					
2.5 TDi (18)	79		11.01	03.02					
2.8 HDi (18)	94		11.01	03.02					



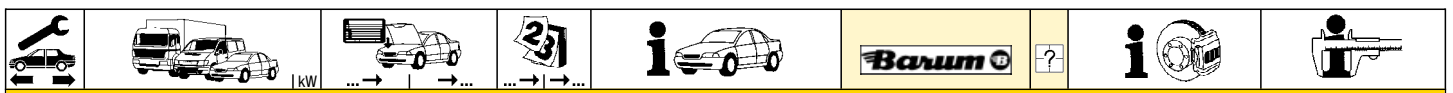

**PEUGEOT BOXER Pritsche/Fahrgestell (94-02)**

	1.9 TD (10/14)	66	12.98	12.99	BAR18108		280 18,0 15,9
	1.9 TD (10/14)	68	07.96	12.99			
	2.0 i (10/14)	80	06.94	12.99			
	2.5 D (14)	63	02.94	12.99			
	2.5 TD (14)	76	02.94	03.02	BAR24127		280 24,0 21,9 V
	2.5 TDi (14)	79	01.97	03.02			
	2.8 HDi (14)	94	11.00	03.02			
	2.0 i (18)	80	06.94	03.02			
	2.5 D (18)	63	02.94	03.02	BAR24138		300 24,0 21,9 V
	2.5 TD (18)	76	02.94	03.02			
	2.5 TDi (18)	79	01.97	03.02			
	2.8 HDi (18)	94	11.00	03.02			
	1.9 TD (10/14)	66	11.01	03.02	BA2323		23921 20,0 /Zub BRE
	1.9 TD (10/14)	68	11.01	03.02			
	2.0 i (10/14/18)	80	11.01	03.02			
	2.5 D (14/18)	63	11.01	03.02			
	2.5 TD (14/18)	76	11.01	03.02			
	2.5 TDi (14/18)	79	11.01	03.02			
	2.8 HDi (14/18)	94	11.01	03.02			
	2.5 TD (14)	76	02.94	10.01	BAW2600		Rz 26,99
	2.5 TDi (14)	79	01.97	10.01			
	2.8 HDi (14)	94	11.00	10.01			
	1.9 TD (10/14)	66	11.01	03.02	BAW2600		Rz 26,99
	1.9 TD (10/14)	68	11.01	03.02			
	2.0 i (10/14)	80	11.01	03.02			
	2.5 D (14)	63	11.01	03.02			
	2.5 TD (14)	76	11.01	03.02			
	2.5 TDi (14)	79	11.01	03.02			
	2.8 HDi (14)	94	11.01	03.02			
	2.0 i (18)	80	06.94	10.01			
	2.5 D (18)	63	02.94	10.01			
	2.5 TD (18)	76	02.94	10.01			
2.5 TDi (18)	79	01.97	10.01				
	2.8 HDi (18)	94	11.00	10.01	BAW2800		Rz 28,57
	1.9 TD (10/14)	66	12.98	10.01			
	1.9 TD (10/14)	68	07.96	10.01			
	2.0 i (10/14)	80	06.94	10.01			
	2.5 D (14)	63	02.94	10.01			
	2.5 TD (14)	76	02.94	10.01			
	2.5 TDi (14)	79	01.97	10.01			
	2.8 HDi (14)	94	11.00	10.01			
	1.9 TD (10/14)	66	11.01	03.02			
	1.9 TD (10/14)	68	11.01	03.02			
2.0 i (10/14)	80	11.01	03.02				
2.5 D (14)	63	11.01	03.02				
2.5 TD (14)	76	11.01	03.02				
2.5 TDi (14)	79	11.01	03.02				
2.8 HDi (14)	94	11.01	03.02				
2.0 i (18)	80	06.94	10.01				
2.5 D (18)	63	02.94	10.01				
2.5 TD (18)	76	02.94	10.01				
2.5 TDi (18)	79	01.97	10.01				
2.8 HDi (18)	94	11.00	10.01				
	1.9 TD (10/14)	66	11.01	03.02	BAE5032	- Quick Fit	254 x 57 HEB AP
	1.9 TD (10/14)	68	11.01	03.02			
	2.0 i (10/14)	80	11.01	03.02			
	2.5 D (14)	63	11.01	03.02			
	2.5 TD (14)	76	11.01	03.02			
	2.5 TDi (14)	79	11.01	03.02			
	2.8 HDi (14)	94	11.01	03.02			
	2.0 i (18)	80	06.94	10.01			
	2.5 D (18)	63	02.94	10.01			
	2.5 TD (18)	76	02.94	10.01			
2.5 TDi (18)	79	01.97	10.01				
2.8 HDi (18)	94	11.00	10.01				
	2.0 i (18)	80	06.94	10.01	BAE5042		254 x 57 HEB LUC
	2.5 D (18)	63	02.94	10.01			
	2.5 TD (18)	76	02.94	10.01			
	2.5 TDi (18)	79	01.97	10.01			
	2.8 HDi (18)	94	11.00	10.01			

**PEUGEOT BOXER (02-06)**

	2.0 HDi (10/14)	62	04.02	03.06	BA2241		23917 19,0 +/-WK/Zub BRE
	2.0 i (10/14)	81	04.02	03.06			
	2.2 HDi (10/14)	74	04.02	03.06			
	2.8 HDi (10/14)	74	04.02	03.06			
	2.0 HDi (18)	62	04.02	03.06	BA2324		23919 18,3 +/-WK/Zub BRE
	2.0 i (18)	81	04.02	03.06			
	2.2 HDi (18)	74	04.02	03.06			
	2.8 HDi (18)	74	04.02	03.06			
	2.0 HDi (10/14)	62	04.02	03.06	BAR24127		280 24,0 21,9 V
	2.0 i (10/14)	81	04.02	03.06			
	2.2 HDi (10/14)	74	04.02	03.06			
	2.8 HDi (10/14)	74	04.02	03.06			
	2.0 HDi (18)	62	04.02	03.06	BAR24138		300 24,0 21,9 V
	2.0 i (18)	81	04.02	03.06			
	2.2 HDi (18)	74	04.02	03.06			
	2.8 HDi (18)	74	04.02	03.06			
	2.0 HDi (10/14/18)	62	04.02	03.06	BA2323		23921 20,0 /Zub BRE
	2.0 i (10/14/18)	81	04.02	03.06			
	2.2 HDi (10/14/18)	74	04.02	03.06			
	2.8 HDi (10/14/18)	74	04.02	03.06			
	2.0 HDi (10/14)	62	04.02	03.06	BAW2600		Rz 26,99
	2.0 i (10/14)	81	04.02	03.06			
	2.2 HDi (10/14)	74	04.02	03.06			
	2.8 HDi (10/14)	74	04.02	03.06			
	2.0 HDi (10/14)	62	04.02	03.06	BAE5032	- Quick Fit	254 x 57 HEB AP
	2.0 i (10/14)	81	04.02	03.06			
	2.2 HDi (10/14)	74	04.02	03.06			
	2.8 HDi (10/14)	74	04.02	03.06			

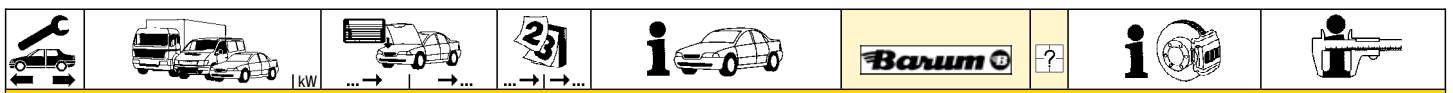

### PEUGEOT BOXER (06-)

	2.2 HDi 100	74		<b>04.06</b>	Nutzlast 120/140 <sup>1)</sup>	<b>BA2275</b>			<b>24468</b> 18,5 +/WK/Zub <b>BRE</b>
	2.2 HDi 110	81		<b>03.11</b>	Nutzlast 120/140 <sup>1)</sup>				
	2.2 HDi 120	88		<b>04.06</b>	Nutzlast 120/140 <sup>1)</sup>				
	2.2 HDi 130	96		<b>03.11</b>	Nutzlast 120/140 <sup>1)</sup>				
	2.2 HDi 150	110		<b>03.11</b>	Nutzlast 120/140 <sup>1)</sup>				
	3.0 D	115		<b>02.07</b>	Nutzlast 120/140 <sup>1)</sup>				
	3.0 HDi 145	107		<b>04.10</b>	Nutzlast 120/140 <sup>1)</sup>				
	3.0 HDi 160	116		<b>04.06</b>	Nutzlast 120/140 <sup>1)</sup>				
	3.0 HDi 175	130		<b>03.11</b>	Nutzlast 120/140 <sup>1)</sup>				
	2.2 HDi 100	74		<b>04.06</b>	Nutzlast leicht 16Q <sup>2)</sup>				
2.2 HDi 110	81		<b>03.11</b>	Nutzlast leicht 16Q <sup>2)</sup>					
2.2 HDi 120	88		<b>04.06</b>	Nutzlast leicht 16Q <sup>2)</sup>					
2.2 HDi 130	96		<b>03.11</b>	Nutzlast leicht 16Q <sup>2)</sup>					
2.2 HDi 150	110		<b>03.11</b>	Nutzlast leicht 16Q <sup>2)</sup>					
3.0 D	115		<b>02.07</b>	Nutzlast leicht 16Q <sup>2)</sup>					
3.0 HDi 145	107		<b>04.10</b>	Nutzlast leicht 16Q <sup>2)</sup>					
3.0 HDi 160	116		<b>04.06</b>	Nutzlast leicht 16Q <sup>2)</sup>					
3.0 HDi 175	130		<b>03.11</b>	Nutzlast leicht 16Q <sup>2)</sup>					
2.2 HDi 100	74		<b>04.06</b>	Nutzlast schwer 16Q <sup>3)</sup>	<b>BA2328</b>			<b>24466</b> 19,1 +/WK/Zub <b>BRE</b>	
2.2 HDi 110	81		<b>03.11</b>	Nutzlast schwer 16Q <sup>3)</sup>					
2.2 HDi 120	88		<b>04.06</b>	Nutzlast schwer 16Q <sup>3)</sup>					
2.2 HDi 130	96		<b>03.11</b>	Nutzlast schwer 16Q <sup>3)</sup>					
2.2 HDi 150	110		<b>03.11</b>	Nutzlast schwer 16Q <sup>3)</sup>					
3.0 D	115		<b>02.07</b>	Nutzlast schwer 16Q <sup>3)</sup>					
3.0 HDi 145	107		<b>04.10</b>	Nutzlast schwer 16Q <sup>3)</sup>					
3.0 HDi 160	116		<b>04.06</b>	Nutzlast schwer 16Q <sup>3)</sup>					
3.0 HDi 175	130		<b>03.11</b>	Nutzlast schwer 16Q <sup>3)</sup>					
	2.2 HDi 100	74		<b>04.06</b>					Nutzlast 120/140 <sup>1)</sup>
	2.2 HDi 110	81		<b>03.11</b>	Nutzlast 120/140 <sup>1)</sup>				
	2.2 HDi 120	88		<b>04.06</b>	Nutzlast 120/140 <sup>1)</sup>				
	2.2 HDi 130	96		<b>03.11</b>	Nutzlast 120/140 <sup>1)</sup>				
	2.2 HDi 150	110		<b>03.11</b>	Nutzlast 120/140 <sup>1)</sup>				
	3.0 D	115		<b>02.07</b>	Nutzlast 120/140 <sup>1)</sup>				
	3.0 HDi 145	107		<b>04.10</b>	Nutzlast 120/140 <sup>1)</sup>				
	3.0 HDi 160	116		<b>04.06</b>	Nutzlast 120/140 <sup>1)</sup>				
	3.0 HDi 175	130		<b>03.11</b>	Nutzlast 120/140 <sup>1)</sup>				
	2.2 HDi 100	74		<b>04.06</b>	Nutzlast schwer 16Q <sup>3)</sup>	<b>BAR24138</b>			300 24,0 21,9 V
2.2 HDi 110	81		<b>03.11</b>	Nutzlast schwer 16Q <sup>3)</sup>					
2.2 HDi 120	88		<b>04.06</b>	Nutzlast schwer 16Q <sup>3)</sup>					
2.2 HDi 130	96		<b>03.11</b>	Nutzlast schwer 16Q <sup>3)</sup>					
2.2 HDi 150	110		<b>03.11</b>	Nutzlast schwer 16Q <sup>3)</sup>					
3.0 D	115		<b>02.07</b>	Nutzlast schwer 16Q <sup>3)</sup>					
3.0 HDi 145	107		<b>04.10</b>	Nutzlast schwer 16Q <sup>3)</sup>					
3.0 HDi 160	116		<b>04.06</b>	Nutzlast schwer 16Q <sup>3)</sup>					
3.0 HDi 175	130		<b>03.11</b>	Nutzlast schwer 16Q <sup>3)</sup>					
	2.2 HDi 100	74		<b>04.06</b>					
	2.2 HDi 110	81		<b>03.11</b>					
	2.2 HDi 120	88		<b>04.06</b>					
	2.2 HDi 130	96		<b>03.11</b>					
	2.2 HDi 150	110		<b>03.11</b>					
	3.0 D	115		<b>02.07</b>					
	3.0 HDi 145	107		<b>04.10</b>					
	3.0 HDi 160	116		<b>04.06</b>					
	3.0 HDi 175	130		<b>03.11</b>					

### PEUGEOT EXPERT Kombi (95-06)

	1.6	58	ORGA 09792	<b>10.95</b>		<b>BA2047</b>			<b>21801</b> 19,0 +/WK/S <b>LUC</b>
	1.8	74	ORGA 09792	<b>10.96</b>					
	1.9 D	51	ORGA 09155	<b>10.95</b>					
	1.9 TD	66	ORGA 09792	<b>10.95</b>					
	1.9 TD	68	ORGA 09792	<b>04.96</b>					
	2.0 16V	100	ORGA 09792	<b>07.00</b>					
	2.0 HDi	69	ORGA 09792	<b>07.00</b>					
	2.0 HDi	80	ORGA 09792	<b>07.00</b>					
1.6	58	ORGA 09155	<b>01.96</b>		<b>BA2079</b>			<b>23042</b> 18,7 /WK <b>BDX</b>	
1.9 D	51	ORGA 09156							
1.6	58	ORGA 09793		<b>12.06</b>	<b>BA2285</b>			<b>20261</b> 19,3 +/WK/S <b>LUC</b>	
1.8	74	ORGA 09793		<b>12.06</b>					
1.9 TD	66	ORGA 09793		<b>12.06</b>					
1.9 TD	68	ORGA 09793		<b>12.06</b>					
2.0 16V	100	ORGA 09793		<b>12.06</b>					
2.0 HDi	69	ORGA 09793		<b>12.06</b>					
2.0 HDi	80	ORGA 09793		<b>12.06</b>					
1.6	58	ORGA 09792	<b>10.95</b>						<b>BAR20155</b>
1.8	74	ORGA 09155	<b>10.96</b>						
1.9 D	51	ORGA 09155	<b>10.95</b>						
1.9 TD	66	ORGA 09155	<b>10.95</b>						
1.9 TD	68	ORGA 09155	<b>04.96</b>						
2.0 16V	100	ORGA 09155	<b>07.00</b>						
2.0 HDi	69	ORGA 09155	<b>07.00</b>						
2.0 HDi	80	ORGA 09155	<b>07.00</b>						
1.6	58	ORGA 09792	<b>10.95</b>		<b>BAR26104</b>			281 26,0 24,2 V	
1.8	74	ORGA 09792	<b>10.96</b>						
1.9 D	51	ORGA 09792	<b>10.95</b>						
1.9 TD	66	ORGA 09792	<b>10.95</b>						
1.9 TD	68	ORGA 09792	<b>04.96</b>						

<sup>1)</sup> payload 120/140 / carico utile 120/140 / charge utile 120/140 / carga útil 120/140

<sup>2)</sup> light payload 16Q / carico utile leggero 16Q / charge utile légère 16Q / carga útil ligera 16Q

<sup>3)</sup> heavy payload 16Q / carico utile pesante 16Q / charge utile lourde 16Q / carga útil pesada 16Q

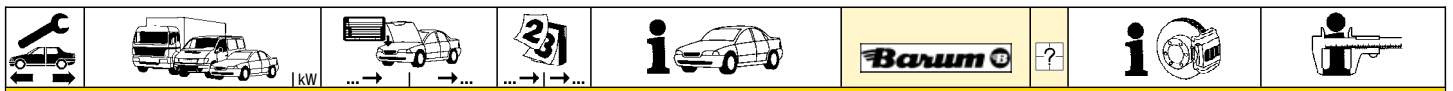























**PEUGEOT EXPERT Kombi (95-06)**

	2.0 16V	100	ORGA 09792	<b>07.00</b>		BAR26104		281 26,0 24,2 V
	2.0 HDi	69	ORGA 09792	<b>07.00</b>				
	2.0 HDi	80	ORGA 09792	<b>07.00</b>				
	1.6	58	ORGA 09793		<b>12.06</b>	BAR28136		285 28,0 26,0 V
	1.8	74	ORGA 09793		<b>12.06</b>			
	1.9 D	51	ORGA 09793		<b>12.06</b>			
	1.9 TD	66	ORGA 09793		<b>12.06</b>			
	1.9 TD	68	ORGA 09793		<b>12.06</b>			
	2.0 16V	100	ORGA 09793		<b>12.06</b>			
	2.0 HDi	69	ORGA 09793		<b>12.06</b>			
	2.0 HDi	80	ORGA 09793		<b>12.06</b>			
	1.6	58		<b>10.95</b>	<b>12.06</b>	BAW1906		Rz 19,05
	1.8	74		<b>10.96</b>	<b>12.06</b>			
	1.9 D	51		<b>10.95</b>	<b>12.06</b>			
	1.9 TD	66		<b>10.95</b>	<b>12.06</b>			
	1.9 TD	68		<b>04.96</b>	<b>12.06</b>			
	2.0 16V	100		<b>07.00</b>	<b>12.06</b>			
	2.0 HDi	69		<b>07.00</b>	<b>12.06</b>			
	2.0 HDi	80		<b>07.00</b>	<b>12.06</b>			
	1.6	58		<b>10.95</b>	<b>12.06</b>	BAE5037		255 x 61
	1.8	74		<b>10.96</b>	<b>12.06</b>			
	1.9 D	51		<b>10.95</b>	<b>12.06</b>			
	1.9 TD	66		<b>10.95</b>	<b>12.06</b>			
	1.9 TD	68		<b>04.96</b>	<b>12.06</b>			

**PEUGEOT EXPERT Kasten (95-06)**

	1.6	58	ORGA 09155	<b>10.95</b>	+ 0,8 t	BA2079		23042 18,7 /WK <b>BDX</b>	
	1.8	74	ORGA 09155	<b>10.96</b>	+ 0,8 t				
	1.9 D	51	ORGA 09155	<b>10.95</b>	+ 0,8 t				
	1.9 TD	66	ORGA 09155	<b>10.95</b>	+ 0,8 t				
	1.9 TD	68	ORGA 09155	<b>04.96</b>	+ 0,8 t				
	2.0 16V	100	ORGA 09155	<b>07.00</b>	+ 0,8 t				
	2.0 HDi	69	ORGA 09155	<b>07.00</b>	+ 0,8 t				
	2.0 HDi	80	ORGA 09155	<b>07.00</b>	+ 0,8 t				
		1.6	58	ORGA 09156		+ 0,8 t	BA2047		21801 19,0 +/-WK/S <b>LUC</b>
		1.6	58	ORGA 09792	<b>10.95</b>	+ 0,9 t			
1.8		74	ORGA 09156		+ 0,8 t				
1.8		74	ORGA 09792	<b>10.96</b>	+ 0,9 t				
1.9 D		51	ORGA 09156		+ 0,8 t				
1.9 D		51	ORGA 09792	<b>10.95</b>	+ 0,9 t				
1.9 TD		66	ORGA 09156		+ 0,8 t				
1.9 TD		66	ORGA 09792	<b>10.95</b>	+ 0,9 t				
1.9 TD		68	ORGA 09156		+ 0,8 t				
1.9 TD		68	ORGA 09792	<b>04.96</b>	+ 0,9 t				
	2.0 16V	100	ORGA 09156		+ 0,8 t				
	2.0 16V	100	ORGA 09792	<b>07.00</b>	+ 0,9 t				
	2.0 HDi	69	ORGA 09156		+ 0,8 t				
	2.0 HDi	69	ORGA 09792	<b>07.00</b>	+ 0,9 t				
	2.0 HDi	80	ORGA 09156		+ 0,8 t				
	2.0 HDi	80	ORGA 09792	<b>07.00</b>	+ 0,9 t				
	1.6	58	ORGA 09793		<b>12.06</b> + 0,8/0,9 t	BA2285		20261 19,3 +/-WK/S <b>LUC</b>	
	1.8	74	ORGA 09793		<b>12.06</b> + 0,8/0,9 t				
	1.9 D	51	ORGA 09793		<b>12.06</b> + 0,8/0,9 t				
	1.9 TD	66	ORGA 09793		<b>12.06</b> + 0,8/0,9 t				
	1.9 TD	68	ORGA 09793		<b>12.06</b> + 0,8/0,9 t				
	2.0 16V	100	ORGA 09793		<b>12.06</b> + 0,8/0,9 t				
	2.0 HDi	69	ORGA 09793		<b>12.06</b> + 0,8/0,9 t				
	2.0 HDi	80	ORGA 09793		<b>12.06</b> + 0,8/0,9 t				
	1.6	58	ORGA 09155	<b>10.95</b>	+ 0,8 t	BAR20155		258 20,0 18,2 V L	
	1.8	74	ORGA 09155	<b>10.96</b>	+ 0,8 t				
	1.9 D	51	ORGA 09155	<b>10.95</b>	+ 0,8 t				
	1.9 TD	66	ORGA 09155	<b>10.95</b>	+ 0,8 t				
	1.9 TD	68	ORGA 09155	<b>04.96</b>	+ 0,8 t				
	1.9 TD	68	ORGA 09155	<b>07.00</b>	+ 0,8 t				
	2.0 16V	100	ORGA 09155	<b>07.00</b>	+ 0,8 t				
	2.0 HDi	69	ORGA 09155	<b>07.00</b>	+ 0,8 t				
	2.0 HDi	80	ORGA 09155	<b>07.00</b>	+ 0,8 t				
	1.6	58	ORGA 09156		+ 0,8 t	BAR26104		281 26,0 24,2 V	
	1.6	58	ORGA 09792	<b>10.95</b>	+ 0,9 t				
	1.8	74	ORGA 09156		+ 0,8 t				
	1.8	74	ORGA 09792	<b>10.96</b>	+ 0,9 t				
	1.9 D	51	ORGA 09156		+ 0,8 t				
	1.9 D	51	ORGA 09792	<b>10.95</b>	+ 0,9 t				
	1.9 TD	66	ORGA 09156		+ 0,8 t				
	1.9 TD	66	ORGA 09792	<b>10.95</b>	+ 0,9 t				
	1.9 TD	68	ORGA 09156		+ 0,8 t				
	1.9 TD	68	ORGA 09792	<b>04.96</b>	+ 0,9 t				
	2.0 16V	100	ORGA 09156		+ 0,8 t				
	2.0 16V	100	ORGA 09792	<b>07.00</b>	+ 0,9 t				
	2.0 HDi	69	ORGA 09156		+ 0,8 t				
	2.0 HDi	69	ORGA 09792	<b>07.00</b>	+ 0,9 t				
	2.0 HDi	80	ORGA 09156		+ 0,8 t				
	2.0 HDi	80	ORGA 09792	<b>07.00</b>	+ 0,9 t				
	1.6	58	ORGA 09793		<b>12.06</b> + 0,8 t	BAR28136		285 28,0 26,0 V	

								
<b>PEUGEOT EXPERT Kasten (95-06)</b>								
	1.6 1.8 1.8 1.9 D 1.9 D 1.9 TD 1.9 TD 1.9 TD 1.9 TD 1.9 TD 2.0 16V 2.0 16V 2.0 HDi 2.0 HDi 2.0 HDi 2.0 HDi	58 74 ORGA 09793 74 ORGA 09793 51 ORGA 09793 51 ORGA 09793 66 ORGA 09793 66 ORGA 09793 68 ORGA 09793 68 ORGA 09793 100 ORGA 09793 100 ORGA 09793 69 ORGA 09793 69 ORGA 09793 80 ORGA 09793 80 ORGA 09793		12.06 +0,9 t 12.06 +0,8 t 12.06 +0,9 t 12.06 +0,8 t 12.06 +0,9 t 12.06 +0,8 t 12.06 +0,9 t 12.06 +0,8 t 12.06 +0,9 t 12.06 +0,8 t 12.06 +0,9 t 12.06 +0,8 t 12.06 +0,9 t 12.06 +0,8 t 12.06 +0,9 t		BAR28136		285 28,0 26,0 V
	1.6 1.8 1.9 D 1.9 TD 1.9 TD 2.0 16V 2.0 HDi 2.0 HDi	58 74 51 66 68 100 69 80		10.95 12.06 10.96 12.06 10.95 12.06 10.95 12.06 04.96 12.06 07.00 12.06 07.00 12.06 07.00 12.06		BAW1906		Rz 19,05
	1.6 1.8 1.9 D 1.9 TD 1.9 TD 2.0 16V 2.0 HDi 2.0 HDi	58 74 51 66 68 100 69 80		10.95 12.06 10.96 12.06 10.95 12.06 10.95 12.06 04.96 12.06 07.00 12.06 07.00 12.06 07.00 12.06		BAE5037		255 x 61
<b>PEUGEOT EXPERT Pritsche/Fahrgestell (95-06)</b>								
	1.6 1.9 D 1.9 TD 1.9 TD	58 51 66 68	ORGA 09792 ORGA 09792 ORGA 09792 ORGA 09792	10.95 10.95 10.95 04.96		BA2047		21801 19,0 +/WK/S LUC
	1.6 1.9 D 1.9 TD 1.9 TD	58 ORGA 09793 51 ORGA 09793 66 ORGA 09793 68 ORGA 09793		12.06 12.06 12.06 12.06		BA2285		20261 19,3 +/WK/S LUC
	1.6 1.9 D 1.9 TD 1.9 TD	58 51 66 68	ORGA 09792 ORGA 09792 ORGA 09792 ORGA 09792	10.95 10.95 10.95 04.96		BAR26104		281 26,0 24,2 V
	1.6 1.9 D 1.9 TD 1.9 TD	58 ORGA 09793 51 ORGA 09793 66 ORGA 09793 68 ORGA 09793		12.06 12.06 12.06 12.06		BAR28136		285 28,0 26,0 V
	1.6 1.9 D 1.9 TD 1.9 TD	58 51 66 68		10.95 12.06 10.95 12.06 10.95 12.06 04.96 12.06		BAW1906		Rz 19,05
	1.6 1.9 D 1.9 TD 1.9 TD	58 51 66 68		10.95 12.06 10.95 12.06 10.95 12.06 04.96 12.06		BAE5037		255 x 61
<b>PEUGEOT EXPERT Tepee (07-)</b>								
	1.6 HDi 90 2.0 HDi 100 2.0 HDi 120 2.0 HDi 120 4x4 2.0 HDi 130 2.0 HDi 140 2.0 HDi 165 2.0 i 16V	66 72 88 88 94 100 120 103		01.07 03.11 01.07 01.07 03.11 01.07 09.09 01.07		BA2329		24595 18,9 +/WK/S LUC
	1.6 HDi 90 2.0 HDi 100 2.0 HDi 120 2.0 HDi 120 4x4 2.0 HDi 130 2.0 HDi 140 2.0 HDi 165 2.0 i 16V	66 72 88 88 94 100 120 103		01.07 03.11 01.07 01.07 03.11 01.07 09.09 01.07		BA2330		24578 16,3 /S LUC
	1.6 HDi 90	66		01.07		BAE5042		254 x 57 HEB LUC
<b>PEUGEOT PARTNER Kombi (96-08)</b>								
	1.1 i 1.4 i 1.6 16V 1.8 i 1.9 D 1.9 D	44 55 80 66 50 51		07.96 09.02 07.96 09.02 ORGA 09127 07.01 ORGA 09127 05.97 ORGA 09127 07.96 ORGA 09127 12.98		BA2021		23124 19,0 +/WK/S LUC
								

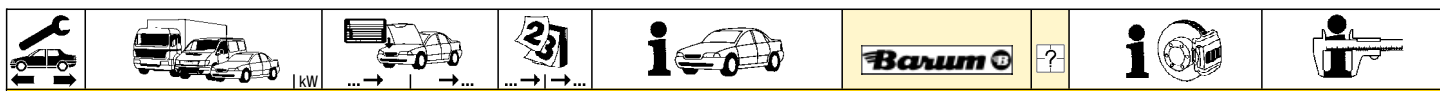























**PEUGEOT PARTNER Kombi (96-08)**





















	2.0 HDi 90	66	ORGA 09127	02.00		BA2021		23124 19,0 +/WK/S	LUC
	1.1 i	44		10.02	03.08	BA2214		23599 19,0 /S	BOS
	1.4 i	55		10.02	03.08				
	1.6 16V	80	ORGA 09128		03.08				
	1.6 HDi 75	55		02.06	03.08				
	1.6 HDi 90	66		02.06	03.08				
	1.8 i	66	ORGA 09128		03.08				
	1.9 D	50	ORGA 09128		03.08				
	1.9 D	51	ORGA 09128		03.08				
	2.0 HDi 90	66	ORGA 09128		03.08				
	1.6 16V	80	ORGA 09128		03.08	BA2229		23600 19,0 /S	BOS
	1.6 HDi 75	55		02.06	03.08				
	1.6 HDi 90	66		02.06	03.08				
	2.0 HDi 90	66	ORGA 09128		03.08				
	1.1 i	44		07.96	09.02	BAR13184		266 13,0 11,0	
	1.4 i	55		07.96	09.02				
	1.4 i	55	ORGA 09127	10.02		BAR20133		266 20,5 18,5 V	
	1.6 16V	80	ORGA 09127	07.01					
	1.8 i	66	ORGA 09127	05.97					
	1.9 D	50	ORGA 09127	07.96					
	1.9 D	51	ORGA 09127	12.98					
	2.0 HDi 90	66	ORGA 09127	02.00					
	1.1 i	44		10.02	03.08	BAR22194		266 22,0 20,0 V	
	1.4 i	55	ORGA 09128		03.08				
	1.6 16V	80	ORGA 09128		03.08				
	1.6 HDi 75	55		02.06	03.08				
	1.6 HDi 90	66		02.06	03.08				
	1.8 i	66	ORGA 09128		03.08				
	1.9 D	50	ORGA 09128		03.08				
	1.9 D	51	ORGA 09128		03.08				
	2.0 HDi 90	66	ORGA 09128		03.08				
	1.6 16V	80	ORGA 09128		03.08	BAR26120		283 26,0 24,0 V	
	1.6 HDi 75	55		02.06	03.08				
	1.6 HDi 90	66		02.06	03.08				
	2.0 HDi 90	66	ORGA 09128		03.08				
	1.6 16V	80		07.01	03.08	BA2017		20961 17,2 /S	LUC
	1.6 HDi 75	55		02.06	03.08				
	1.6 HDi 90	66		02.06	03.08				
	2.0 HDi 90	66		02.00	03.08				
	1.6 16V	80		07.01	03.08	BAR09137		247 9,0 8,0	
	1.6 HDi 75	55		02.06	03.08				
	1.6 HDi 90	66		02.06	03.08				
	2.0 HDi 90	66		02.00	03.08				
	1.1 i	44		07.96	03.08	BAW2205		Rz 22,20	LUC
	1.4 i	55		07.96	03.08				
	1.6 16V	80		07.01	03.08				
	1.6 HDi 75	55		02.06	03.08				
	1.6 HDi 90	66		02.06	03.08				
	1.8 i	66		05.97	03.08				
	1.9 D	50		07.96	03.08				
	1.9 D	51		12.98	03.08				
	2.0 HDi 90	66		02.00	03.08				
	1.1 i	44		07.96	03.08	BAE5019		229 x 42 HEB	LUC
	1.4 i	55		07.96	03.08				
	1.6 16V	80		07.01	03.08				
	1.6 HDi 75	55		02.06	03.08				
	1.6 HDi 90	66		02.06	03.08				
	1.8 i	66		05.97	03.08				
	1.9 D	50		07.96	03.08				
	1.9 D	51		12.98	03.08				
	2.0 HDi 90	66		02.00	03.08				

**PEUGEOT PARTNER Kasten (96-08)**

	1.1 i	44		07.96	09.02	BA2021		23124 19,0 +/WK/S	LUC
	1.4 i	55		07.96	09.02				
	1.8 D	43	ORGA 09127	07.96					
	1.8 D	44	ORGA 09127	11.96					
	1.9 D	51	ORGA 09127	07.96					
	2.0 HDi 90	66	ORGA 09127	04.00					
	1.1 i	44		10.02	03.08	BA2214		23599 19,0 /S	BOS
	1.4 i	55		10.02	03.08				
	1.6 HDi 75	55		02.06	03.08				
	1.6 HDi 90	66		02.06	03.08				
	1.8 D	43	ORGA 09128		03.08				
	1.8 D	44	ORGA 09128		02.98				
	1.9 D	51	ORGA 09128		03.08				
	2.0 HDi 90	66	ORGA 09128		03.08				
	2.0 HDi 90	66	ORGA 09128		03.08	BA2229		23600 19,0 /S	BOS
	1.1 i	44		07.96	09.02	BAR13184		266 13,0 11,0	
	1.4 i	55		07.96	09.02				
	1.8 D	43	ORGA 09127	07.96		BAR20133		266 20,5 18,5 V	
	1.8 D	44	ORGA 09127	11.96					
	1.9 D	51	ORGA 09127	07.96					
	2.0 HDi 90	66	ORGA 09127	04.00					
	1.1 i	44		10.02	03.08	BAR22194		266 22,0 20,0 V	

								
<b>PEUGEOT PARTNER Kasten (96-08)</b>								
	1.4 i 1.6 HDi 75 1.6 HDi 90 1.8 D 1.8 D 1.9 D 2.0 HDi 90 2.0 HDi 90	55 55 66 43 ORGA 09128 44 ORGA 09128 51 ORGA 09128 66 ORGA 09128 66 ORGA 09128	10.02 02.06 02.06	03.08 03.08 03.08 03.08 02.98 03.08 03.08 03.08		BAR22194		266 22,0 20,0 V
	2.0 HDi 90	66	04.00	03.08 + ESP		BAR26120 BA2017		283 26,0 24,0 V 20961 17,2 /S LUC
	2.0 HDi 90	66	04.00	03.08 + ESP		BAR09137		247 9,0 8,0
	1.1 i 1.4 i 1.6 HDi 75 1.6 HDi 90 1.8 D 1.8 D 1.9 D 2.0 HDi 90 Electric	44 55 55 66 43 44 51 66 28	07.96 07.96 02.06 02.06 07.96 11.96 07.96 04.00 01.98	03.08 03.08 03.08 03.08 03.08 02.98 03.08 03.08 12.01		BAW2205 BAW2205		Rz 22,20 LUC Rz 22,20 LUC
	1.1 i 1.4 i 1.6 HDi 75 1.6 HDi 90 1.8 D 1.8 D 1.9 D 2.0 HDi 90	44 55 55 66 43 44 51 66	07.96 07.96 02.06 02.06 07.96 11.96 07.96 04.00	03.08 03.08 03.08 03.08 03.08 02.98 03.08 03.08		BAE5019		229 x 42 HEB LUC
<b>PEUGEOT PARTNER Tepee/Kasten (B9) (08-)</b>								
	1.6 1.6 1.6 HDi 1.6 HDi 1.6 HDi 1.6 HDi 1.6 i 16V 1.6 i 16V	72 88 55 66 80 82 66 80	08.10 04.10 04.08 04.08 04.08 08.10 04.08 04.08			BAR26120		283 26,0 24,0 V
<b>PORSCHE 911 (996) (97-05)</b>								
	3.4 CARRERA 3.4 CARRERA 4 3.6 CARRERA 3.6 CARRERA 4 3.6 CARRERA 4 3.6 CARRERA 4 3.6 TURBO 4 3.6 GT3 3.6 GT3		09.97 06.97 10.01 10.01 10.01 01.02 01.02 06.00 03.99 01.03	09.01 09.01 08.05 08.05 08.05 12.02 12.02 08.05 12.02 08.05		BAV1050	2 2 2 2 2	Warnkontakt L=505mm Warnkontakt L=505mm Warnkontakt L=505mm Warnkontakt L=505mm Warnkontakt L=505mm - Keramikbremse 1) - Keramikbremse 1) Warnkontakt L=505mm Warnkontakt L=505mm
	3.4 CARRERA 3.4 CARRERA 4 3.6 CARRERA 3.6 CARRERA 4 3.6 CARRERA 3.6 CARRERA 4 3.6 TURBO 4 3.6 GT3		09.97 06.97 10.01 10.01 01.02 01.02 01.02 03.99	09.01 09.01 08.05 08.05 08.05 08.05 08.08 08.05		BAV1050	2 2 2 2	Warnkontakt L=505mm Warnkontakt L=505mm Warnkontakt L=505mm Warnkontakt L=505mm
<b>PORSCHE 911 TARGA (996) (01-05)</b>								
	3.6	235	12.01	08.05		BAV1050	2	Warnkontakt L=505mm
	3.6	235	12.01	08.05		BAV1050	2	Warnkontakt L=505mm
<b>PORSCHE 911 CABRIO (996) (98-05)</b>								
	3.4 CARRERA 3.4 CARRERA 4 3.6 CARRERA 3.6 CARRERA 4 3.6 CARRERA 4 3.6 CARRERA 4 3.6 TURBO 4		02.98 02.98 10.01 10.01 01.02 01.02 10.03	09.01 09.01 08.05 08.05 08.05 08.05 08.05		BAV1050	2 2 2	Warnkontakt L=505mm Warnkontakt L=505mm Warnkontakt L=505mm - Keramikbremse 1)
	3.4 CARRERA 3.4 CARRERA 4 3.6 CARRERA 3.6 CARRERA 4 3.4 CARRERA 3.4 CARRERA 4 3.6 CARRERA		02.98 02.98 10.01 10.01 02.98 02.98 10.01	09.01 09.01 08.05 08.05 09.01 09.01 08.05		BAV1050	2 2	Warnkontakt L=505mm Warnkontakt L=505mm - Keramikbremse 1)
	↓							

1) - ceramic brake / - freno in ceramica / - frein de céramique / - freno de cerámica

	   kW							
<b>PORSCHE 911 CABRIO (996) (98-05)</b>								
	3.6 CARRERA 4 3.6 TURBO 4		10.01 10.03	08.05 08.05	BAV1050	2	- Keramikbremse <sup>1)</sup>	Warnkontakt L=505mm
<b>PORSCHE 911 COUPE (997) (04-)</b>								
	3.6 Carrera 239 3.6 Carrera 4 239 3.8 Carrera S 261		07.04 07.04 07.04		BAV1050 BAV1050 BAV1050	2 2 2	- Sportausführung/- Keramikbr. <sup>2)</sup> - Keramikbremse <sup>1)</sup> - Keramikbremse <sup>1)</sup>	Warnkontakt L=505mm Warnkontakt L=505mm Warnkontakt L=505mm
<b>PORSCHE 911 CABRIO (997) (05-)</b>								
	3.6 Carrera 239 3.6 Carrera 4 239 3.8 Carrera S 261		04.05 04.05 04.05		BAV1050 BAV1050 BAV1050	2 2 2	- Sportausführung/- Keramikbr. <sup>2)</sup> - Keramikbremse <sup>1)</sup> - Keramikbremse <sup>1)</sup>	Warnkontakt L=505mm Warnkontakt L=505mm Warnkontakt L=505mm
<b>PORSCHE BOXSTER (986) (96-04)</b>								
	2.5 150 2.7 162 2.7 168 3.2 S 185 3.2 S 191 3.2 S 196		09.96 08.99 07.02	07.99 06.02 12.04	BAV1050	2		Warnkontakt L=505mm
	2.5 150 2.7 162 2.7 168 3.2 S 185 3.2 S 191 3.2 S 196		09.96 08.99 07.02	07.99 06.02 12.04	BAV1051	2		Warnkontakt L=505mm
<b>PORSCHE BOXSTER (987) (05-11)</b>								
	3.2 S 206 3.4 S 217 3.4 S 228 3.4 S RS SPYDER 223		11.04 06.06 06.09 08.08	07.06 09.11 09.11 09.11	BAV1051	2	- Keramikbremse <sup>1)</sup>	Warnkontakt L=505mm
<b>PORSCHE CAYENNE I (03-10)</b>								
	3.0 TDI 176 3.2 177 3.2 184 3.6 213 GTS 4.8 298 S 4.5 250 S 4.8 283 Turbo 4.5 331 Turbo 4.8 368 Turbo S 4.5 368 Turbo S 4.5 383 Turbo S 4.8 397 Turbo S 4.8 404		02.09 08.03 10.03 01.07	04.10 + 17" Rad/ + schwarzer Sattel <sup>3)</sup> 04.10 + 17" Rad/ + schwarzer Sattel <sup>3)</sup> 12.06 + 17" Rad/ + schwarzer Sattel <sup>3)</sup> 04.10 + 17" Rad/ + schwarzer Sattel <sup>3)</sup>	BAV1052	2		Warnkontakt L=420mm
	3.0 TDI 176 3.2 177 3.2 184 3.6 213 GTS 4.8 298 S 4.5 250 S 4.8 283 Turbo 4.5 331 Turbo 4.8 368 Turbo S 4.5 368 Turbo S 4.5 383 Turbo S 4.8 397 Turbo S 4.8 404		02.09 08.03 10.03 01.07	04.10 + 18" Rad/ + silberner Sattel <sup>4)</sup> 04.10 + 18" Rad/ + silberner Sattel <sup>4)</sup> 12.06 + 18" Rad/ + silberner Sattel <sup>4)</sup> 04.10 + 18" Rad/ + silberner Sattel <sup>4)</sup>	BAV1052	2		Warnkontakt L=420mm
	3.0 TDI 176 3.2 177 3.2 184 3.6 213 GTS 4.8 298 S 4.5 250 S 4.8 283 Turbo 4.5 331 Turbo 4.8 368 Turbo S 4.5 368 Turbo S 4.5 383 Turbo S 4.8 397 Turbo S 4.8 404		02.09 08.03 10.03 01.07	04.10 + 18" Rad/ + roter Sattel <sup>5)</sup> 04.10 + 18" Rad/ + roter Sattel <sup>5)</sup> 12.06 + 18" Rad/ + roter Sattel <sup>5)</sup> 04.10 + 18" Rad/ + roter Sattel <sup>5)</sup>	BAV1052	2		Warnkontakt L=420mm
	3.2 184 3.6 213 GTS 4.8 298 S 4.5 250 S 4.8 283 Turbo 4.5 331 Turbo 4.8 368 Turbo S 4.5 368 Turbo S 4.5 383 Turbo S 4.8 397 Turbo S 4.8 404		10.03 01.07	12.06 + 17" Rad <sup>6)</sup> 12.09 + 17" Rad <sup>6)</sup>	BAV1053	2		Warnkontakt L=255mm
	3.6 213 GTS 4.8 298 S 4.8 283 Turbo 4.8 368		01.10 01.10 01.10 01.10	+ 17" Rad <sup>6)</sup> + 17" Rad/ + roter Sattel <sup>7)</sup> + 17" Rad <sup>6)</sup> + 17" Rad <sup>6)</sup>	BAV1053			Warnkontakt L=255mm

<sup>1)</sup> - ceramic brake / - freno in ceramica / - frein de céramique / - freno de cerámica

<sup>2)</sup> - sport design/- ceramic brake / - versio.sportiva/-fr.ceramica / - réalis.sport/-fr.d.céramique / - realiz.deporte/- fr.cerámica



















<sup>3)</sup> + 17" wheel/ + black caliper / + ruota 17"/ + pinza nero / + roue 17"/ + étrier noir / + rueda 17"/ + pinza negro

<sup>4)</sup> + 18" wheel/ + silver caliper / + ruota 18"/ + pinza argento / + roue 18"/ + étrier argent / + rueda 18"/ + pinza plata

<sup>5)</sup> + 18" wheel/ + red caliper / + ruota 18"/ + pinza rossa / + roue 18"/ + étrier rouge / + rueda 18"/ + pinza roja

<sup>6)</sup> + 17" wheel / + ruota 17" / + roue 17" / + rueda 17"

<sup>7)</sup> + 17" wheel/ + red caliper / + ruota 17"/ + pinza rossa / + roue 17"/ + étrier rouge / + rueda 17"/ + pinza roja

									
<b>PORSCHE CAYENNE I (03-10)</b>									
	3.2 S 4.5 Turbo 4.5	184 250 331	01.05 01.05 01.05	12.06 + 18" Rad <sup>1)</sup> 12.06 + 18" Rad <sup>1)</sup> 12.06 + 18" Rad <sup>1)</sup>	BAV1053	2		Warnkontakt L=255mm	
<b>PORSCHE CAYMAN (987C) (05-)</b>									
	R 3.4 3.4 S	243 217	11.10 11.05		BAV1051 BAV1051	2 2		Warnkontakt L=505mm Warnkontakt L=505mm	
<b>PROTON PERSONA 400 (94-00)</b>									
	1.6 GLX 1.8 GLX	83 85	01.94 05.96	07.00 07.00	BA2117			21647 16,0 +/-WK SUM	
<b>PROTON SATRIA (00-)</b>									
	1.8 GTi 16V	103	08.00		BA2117			21647 16,0 +/-WK SUM	
<b>RENAULT AVANTIME (01-03)</b>									
	2.0 16V Turbo 3.0 V6 2.2 dCi	120 152 110	11.01 09.01 05.02	06.03 06.03 06.03	BA2254 BA2254			23099 18,4 /S LUC 23099 18,4 /S LUC	
	2.0 16V Turbo 2.2 dCi 3.0 V6	120 110 152	11.01 05.02 09.01	06.03 06.03 06.03	BA2212		Gleitbleche vor dem Einbau entfernen <sup>3)</sup>	23554 16,4 /S LUC	
	2.0 16V Turbo 2.2 dCi 3.0 V6	120 110 152	11.01 05.02 09.01	06.03 06.03 06.03	BAR11151			265 10,5 9,5	
<b>RENAULT CLIO I Limousine (B/C 57_) (90-98)</b>									
	1.1 1.1 1.2 1.2 (5/357F/J/L/R) 1.2 (5/357K.5/357Y) 1.2 (5/357K.5/357Y) 1.2 (B/C 577) 1.2 (B/C 57A/S) 1.2 (B/C 57R) 1.4 1.4 (B/C 57J) 1.4 (B/C 57T/Y) 1.7 1.8 1.8 (B/C 578) 1.8 (B/C 57C/U) 1.8 16V 1.8 Rsi (B/C 579) 1.8 Rsi (B/C 57H) 1.9 D 1.9 D Electric Williams (B/C 57M)	34 34 44 43 40 43 40 43 40 59 55 58 68 70 66 65 99 80 79 40 47 21 108	01.91 05.92 05.90 10.94 01.96 01.96 01.96 05.90 01.91 01.91 01.91 01.91 04.95 01.91 08.94 01.91 08.91 01.93 08.95 01.97 01.91 05.96 01.94	04.92 09.98 03.96 09.98 09.98 09.98 12.96 09.98 01.96 09.98 09.98 04.95 09.98 09.98 06.94 08.95 09.98 09.98 09.98 02.98 09.98	BA2077 BA2023 BA2055 BA2023				21097 15,0 +/-WK BDX 21463 18,0 /WK/S LUC 20905 18,0 +/-WK BDX 21463 18,0 /WK/S LUC
	1.1 1.1 1.2 1.2 (5/357F/J/L/R) 1.2 (5/357K.5/357Y) 1.2 (5/357K.5/357Y) 1.2 (B/C 577) 1.2 (B/C 57A/S) 1.2 (B/C 57R) 1.4 1.4 1.4 (B/C 57J) 1.4 (B/C 57J) 1.4 (B/C 57T/Y) 1.4 (B/C 57T/Y) 1.9 D Electric	34 34 44 43 40 43 40 43 40 59 55 55 58 47 21	01.91 05.92 05.90 10.94 01.96 01.96 01.96 05.90 01.91 01.91 01.91 01.91 01.91 01.91 01.91 05.96	04.92 09.98 03.96 09.98 09.98 09.98 12.96 09.98 01.96 09.98 09.98 + Automatikgetriebe <sup>4)</sup> 09.98 + Schaltgetriebe <sup>5)</sup> 03.96 + Automatikgetriebe <sup>4)</sup> 09.98 + Schaltgetriebe <sup>5)</sup> 03.96 + Automatikgetriebe <sup>4)</sup> 09.98 + Schaltgetriebe <sup>5)</sup>	BAR08104 BAR12116			238 8,2 7,0 238 12,0 10,5	
	1.4 1.4 (B/C 57J) 1.4 (B/C 57T/Y) 1.4 S 1.4 S (B/C 57J) 1.4 S (B/C 57T/Y) 1.7 1.8 1.8 (B/C 578) 1.8 (B/C 57C/U) 1.8 Rsi (B/C 579) 1.8 Rsi (B/C 57H) 1.9 D	59 55 58 59 55 58 68 70 66 65 80 79 40	04.96 04.96 04.96 01.91 01.91 01.91 01.91 01.91 08.94 01.91 01.93 08.95 01.97	09.98 + Automatikgetriebe <sup>4)</sup> 09.98 + Automatikgetriebe <sup>4)</sup> 09.98 + Automatikgetriebe <sup>4)</sup> 09.98 09.98 09.98 04.95 09.98 09.98 09.98 09.98 09.98	BAR20125		238 20,0 17,7 V		

<sup>1)</sup> + 18" wheel / + ruota 18" / + roue 18" / + rueda 18"













<sup>2)</sup> - ceramic brake / - freno in ceramica / - frein de céramique / - freno de cerámica























<sup>3)</sup> remove sliding plates before installation / rimuovere le lamiere di scorrimento prima del montaggio / retirer l'plaques coulissantes avant le montage / elimine las chapas de deslizamiento antes del montaje

<sup>4)</sup> + autom.transmission / + scatola cambio automatico / + transmission automatique / + cambio automático

<sup>5)</sup> + manual transmission / + scatola cambio velocità / + transmission mécanique / + cambio de velocidad



								
<b>RENAULT CLIO I Limousine (B/C 57_) (90-98)</b>								
	1.9 D	47		02.94	09.98			238 20,0 17,7 V
	1.8 16V	99		08.91	06.94			259 20,6 17,7 V
	Williams (B/C 57M)	108		01.94	09.98			
	1.1	34		01.91	09.98		2	L=240
	1.2	44		05.90	03.96			
	1.2 (5/357F/J/L/R)	43		10.94	09.98			
	1.2 (5/357K.5/357Y)	40		01.96	09.98			
	1.2 (5/357K.5/357Y)	43		01.96	09.98			
	1.2 (B/C 577)	40		01.96	12.96			
	1.2 (B/C 57A/S)	43		05.90	09.98			
	1.2 (B/C 57R)	40		01.91	01.96			
	1.4	59		01.91	09.98			
	1.4 (B/C 57J)	55		01.91	09.98			
	1.4 (B/C 57T/Y)	58		01.91	09.98			
	1.7	68		01.91	04.95			
	1.8	70		01.91	09.98			
	1.8 (B/C 578)	66		08.94	09.98			
	1.8 (B/C 57C/U)	65		01.91	09.98			
	1.8 Rsi (B/C 579)	80		01.93	08.95			
	1.8 Rsi (B/C 57H)	79		08.95	09.98			
	1.9 D	40		01.97	09.98			
	1.9 D	47		01.91	09.98			
	Electric	21		05.96	02.98			
	1.1	34		01.91	03.91			RzR 20,64 BDX
	1.2	44		05.90	03.91 - ABS			RzR 20,64 BDX
	1.2 (B/C 57A/S)	43		05.90	03.91 - ABS			
	1.2 (B/C 57R)	40		01.91	03.91 - ABS			
	1.4	59		01.91	03.91 - ABS			
	1.4 (B/C 57J)	55		01.91	03.91 - ABS			
	1.4 (B/C 57T/Y)	58		01.91	03.91 - ABS			
	1.7	68		01.91	03.91 - ABS			
	1.8 (B/C 57C)	65		01.91	03.91 - ABS			
	1.9 D (B/C 576)	47		01.91	03.91 - ABS			
	1.9 D (B/C 57L)	47		01.91	03.91 - ABS			
	Electric	21		05.96	02.98			
	1.1	34		04.91	09.98			RzR 20,64 BDX
	1.2	44		04.91	03.96 - ABS			RzR 20,64 BDX
	1.2 (5/357K.5/357Y)	40		01.96	09.98 - ABS			
	1.2 (5/357K.5/357Y)	43		01.96	09.98 - ABS			
	1.2 (B 57N)	43		09.91	04.96			
	1.2 (B/C 577)	40		01.96	12.96 - ABS			
	1.2 (B/C 57A/S)	43		04.91	09.98 - ABS			
	1.2 (B/C 57R)	40		04.91	01.96 - ABS			
	1.4	59		04.91	04.96 - ABS			
	1.4 (B/C 57J)	55		04.91	04.96 - ABS			
	1.4 (B/C 57T/Y)	58		04.91	04.96 - ABS			
	1.7	68		04.91	04.95 - ABS			
	1.8 (357A)	70		10.94	04.96 - ABS			
	1.8 (357D)	70		10.94	04.96 - ABS			
	1.8 (557A)	70		08.94	04.96 - ABS			
	1.8 (557D)	70		08.94	04.96 - ABS			
	1.8 (B/C 578)	66		08.94	04.96 - ABS			
	1.8 (B/C 57C)	65		04.91	04.96 - ABS			
	1.8 (B/C 57U)	65		01.91	11.96 - ABS			
	1.9 D (B/C 576)	47		04.91	04.96 - ABS			
	1.9 D (B/C 57I)	47		07.92	04.96 - ABS			
	1.9 D (B/C 57L)	47		04.91	04.96 - ABS			
	1.2 (5/357G)	43		01.94	04.96			RzR 20,64 BDX
	1.2 (B 57N)	43		05.96	09.98			RzR 20,64 BDX
	1.4	59		05.96	09.98 - ABS			
	1.4 (B/C 57J)	55		05.96	09.98 - ABS			
	1.4 (B/C 57T/Y)	58		05.96	09.98 - ABS			
	1.8 (557U)	70		09.96	09.98 - ABS			
	1.8 (B/C 578)	66		05.96	09.98 - ABS			
	1.8 (B/C 57C)	65		05.96	09.98 - ABS			
	1.9 D	40		01.97	09.98 - ABS			
	1.9 D (B/C 576)	47		05.96	09.98 - ABS			
	1.9 D (B/C 57I)	47		05.96	09.98 - ABS			
	1.9 D (B/C 57L)	47		05.96	09.98 - ABS			
	1.1	34		01.91	09.98			180 x 42 BDX
	1.2	44		05.90	03.96 - ABS			
	1.2 (5/357G)	43		01.94	04.96			
	1.2 (5/357K.5/357Y)	40		01.96	09.98 - ABS			
	1.2 (5/357K.5/357Y)	43		01.96	09.98 - ABS			
	1.2 (B 57N)	43		09.91	09.98 - ABS			
	1.2 (B/C 577)	40		01.96	12.96 - ABS			
	1.2 (B/C 57A/S)	43		05.90	09.98 - ABS			
	1.2 (B/C 57R)	40		01.91	01.96 - ABS			
	1.4	59		01.91	09.98 - ABS			
	1.4 (B/C 57J)	55		01.91	09.98 - ABS			
	1.4 (B/C 57T/Y)	58		01.91	09.98 - ABS			
	1.7	68		01.91	04.95 - ABS			
	1.8 (357A)	70		10.94	09.98 - ABS			
	1.8 (357D)	70		10.94	04.96 - ABS			
	1.8 (357E)	70		10.94	04.96			
	1.8 (557A)	70		08.94	09.98 - ABS			

								
<b>RENAULT CLIO I Limousine (B/C 57_) (90-98)</b>								
	1.8 (557D) 1.8 (B/C 578) 1.8 (B/C 57C/U) 1.9 D 1.9 D	70 66 65 40 47	08.94 08.94 01.91 01.97 01.91	09.98 09.98 09.98 09.98 09.98	- ABS - ABS - ABS - ABS - ABS	BAE5008		180 x 42 BDX
<b>RENAULT CLIO I Kasten (S 57_) (91-98)</b>								
	1.1 1.1 1.2 1.2 1.9 D	34 34 40 44 48	01.91 05.92 01.91 01.91 01.91	04.92 09.98 09.98 09.98 09.98		BA2077 BA2023 BA2055 BA2023		21097 15,0 +/WK 21463 18,0 /WK/S 20905 18,0 +/WK 21463 18,0 /WK/S BDX LUC
	1.1 1.1 1.2 1.2 1.9 D	34 34 40 44 48	01.91 05.92 01.91 01.91 01.91	04.92 09.98 09.98 09.98 01.94		BAR08104 BAR12116		238 8,2 7,0 238 12,0 10,5
	1.1 1.2 1.2 1.9 D	34 40 44 48	01.91 01.91 01.91 01.91	09.98 09.98 09.98 09.98		BAH0024	2	L=240
	1.1 1.2 1.2 1.9 D	34 40 44 48	01.91 01.91 01.91 01.91	03.91 03.91 03.91 03.91	- ABS - ABS - ABS	BAW2005 BAW2006		RzR 20,64 RzR 20,64 BDX BDX
	1.1 1.2 1.2 1.9 D	34 40 44 48	04.91 04.91 04.91 04.91	09.98 09.98 09.98 04.96	- ABS - ABS - ABS	BAW2005 BAW2006		RzR 20,64 RzR 20,64 BDX BDX
	1.1 1.2 1.2 1.9 D	34 40 44 48	05.96 01.91 01.91 01.91	09.98 09.98 09.98 09.98	- ABS - ABS - ABS	BAW2005 BAW2006 BAE5008		RzR 20,64 RzR 20,64 180 x 42 BDX BDX BDX
<b>RENAULT CLIO II Limousine (BB_/CB_) (98-)</b>								
	1.0 1.2 1.2 1.2 16V 1.4 1.4 16V 1.4 16V 1.5 D 1.5 dCi 1.5 dCi 1.5 dCi 1.5 dCi 1.5 dCi 1.5 dCi 1.6 1.6 16V 1.9 D 1.9 dTi 2.0 16V Sport 2.0 16V Sport	40 43 44 55 55 70 72 50 47 48 59 60 62 74 66 79 59 124 132	02.00 09.98 03.99 06.01 09.98 10.99 08.00 08.04 06.05 06.01 06.01 02.07 01.04 09.98 09.98 09.98 02.00 01.04	05.01 05.01 05.01 06.01 05.05 07.00 08.00 08.04 06.05 10.03 06.01 02.07 01.04 05.05 09.98 05.05 02.00 05.05		BA2023		21463 18,0 /WK/S LUC
	1.0 1.2 1.2 1.2 16V 1.4 (BB/CB0C) 1.4 (BB/CB0S) 1.5 dCi 1.5 dCi 1.9 D	40 43 44 55 55 47 62	02.00 09.98 03.99 06.01 09.98 09.98 06.05 02.07 09.98	05.01 - ABS - ABS - ABS 05.05 05.05 - ABS - ABS 05.05	- ABS - ABS - ABS - ABS - ABS/ + Schaltgetriebe 1) - ABS - ABS - ABS/ - Klimaanlage 2)	BAR12116		238 12,0 10,5
	1.0 1.2 1.2 1.2 16V 1.4 (BB/CB0C) 1.4 (BB/CB0S) 1.4 (BB/CB0S) 1.4 16V 1.4 16V 1.5 dCi 1.5 dCi 1.6	40 43 44 55 55 55 70 72 47 62 66	02.00 09.98 03.99 06.01 09.98 09.98 09.98 10.99 08.00 06.05 02.07 09.98	05.01 + ABS + ABS + ABS 05.05 05.05 05.05 07.00 - ABS - ABS + ABS + ABS 05.05	+ ABS + ABS + ABS + ABS + ABS/ + Automatikgetriebe 3) + ABS/ + Schaltgetriebe 4) - ABS - ABS + ABS + ABS - ABS	BAR20125		238 20,0 17,7 V
	1.0 1.2 1.4 (BB/CB0S) 1.4 16V 1.4 16V	40 43 55 70 72	02.00 06.01 09.98 10.99 08.00	05.01 + ABS 05.05 + ABS/ + Automatikgetriebe 5) 07.00 + ABS + ABS		BAR21106		259 20,6 17,7 V

















1) - ABS/ + manual transmission / - ABS/+ scatola camb.velocità / - ABS/ + transmission mécanique / - ABS/ + cambio de velocidad

2) - ABS/ - air conditioning / - ABS/ - aria condizionata / - ABS/ - air conditionné / - ABS/ - aire acondicionado

3) - ABS/ + autom.transmission / - ABS/ + scatola cambio autom. / - ABS/ + transmission automatique / - ABS/ + cambio automático

4) + ABS/ + manual transm. / + ABS/+ scatola camb.velocità / + ABS/ + transmission mécanique / + ABS/ + cambio de velocidad

5) + ABS/ + autom.transmission / + ABS/ + scatola cambio autom. / + ABS/ + transmission automatique / + ABS/ + cambio automático

	   kW							
<b>RENAULT CLIO II Limousine (BB_/CB_) (98-)</b>								
	1.5 D	50		08.04			BAR21106	259 20,6 17,7 V
	1.5 dCi	48		06.01				
	1.5 dCi	59		06.01	10.03			
	1.5 dCi	60		06.01				
	1.5 dCi	74		01.04				
	1.6	66		09.98	05.05 + ABS			
	1.6 16V	79		09.98				
	1.9 dTi	59		02.00	05.05			
	1.9 D			09.98	05.05		BAR20125 BAR21106	+ ABS/ - Klimaanlage 1) + ABS/ + Klimaanlage 2)
	2.0 16V Sport	124		02.00			BAR24158	280 24,0 21,8 V L
	2.0 16V Sport	132		01.04				
	1.0	40		02.00	05.01 - ABS		BAW1907	Rz 19,05
	1.2	43		09.98	- ABS			
	1.2	44		03.99	05.01 - ABS			
	1.2 16V	55		06.01	- ABS			
	1.4 (BB/CB0C)	55		09.98	05.05 - ABS			
	1.4 (BB/CB0S)	55		09.98	05.05 - ABS/ + Schaltgetriebe 3)			
	1.9 D			09.98	05.05 - ABS/ - Klimaanlage 4)			
	1.0	40		02.00	05.01 + ABS		BAW1704 BAW1707	Rz 17,78
	1.2	43		09.98	+ ABS			
	1.2	44		03.99	05.01 + ABS			
1.2 16V	55		06.01	+ ABS				
1.4 (BB/CB0C)	55		09.98	05.05 + ABS				
1.4 (BB/CB0S)	55		09.98	05.05 + Automatikgetriebe 5)				
1.4 (BB/CB0S)	55		09.98	05.05 + ABS/ + Schaltgetriebe 6)				
1.4 16V	70		10.99	07.00				
1.4 16V	72		08.00					
1.5 D	50		08.04					
1.5 dCi	47		06.05					
1.5 dCi	48		06.01					
1.5 dCi	59		06.01	10.03				
1.5 dCi	60		06.01					
1.5 dCi	62		02.07					
1.5 dCi	74		01.04					
1.6	66		09.98	05.05				
1.6 16V	79		09.98					
1.9 D			09.98	05.05 + ABS/ + Klimaanlage 2)				
1.9 dTi	59		02.00	05.05				
	1.0	40		02.00	05.01 + ABS		BAE5002	203 x 38 HEB
	1.2	43		09.98	+ ABS			
	1.2	44		03.99	05.01 + ABS			
	1.2 16V	55		06.01	+ ABS			
	1.4 (BB/CB0C)	55		09.98	05.05 + ABS			
	1.4 (BB/CB0S)	55		09.98	05.05 + Automatikgetriebe 5)			
	1.4 (BB/CB0S)	55		09.98	05.05 + ABS/ + Schaltgetriebe 6)			
	1.4 16V	70		10.99	07.00			
	1.4 16V	72		08.00				
	1.5 D	50		08.04				
	1.5 dCi	47		06.05				
	1.5 dCi	48		06.01	+ ABS			
	1.5 dCi	59		06.01	10.03			
	1.5 dCi	60		06.01				
	1.5 dCi	62		02.07	+ ABS			
1.5 dCi	74		01.04					
1.6	66		09.98	05.05				
1.6 16V	79		09.98					
1.9 D			09.98	05.05 + ABS/ + Klimaanlage 2)				
1.9 dTi	59		02.00	05.05				
<b>RENAULT CLIO II Kasten (SB_) (98-)</b>								
	1.2	43		09.98			BA2023	21463 18,0 /WK/S
	1.2	44		03.99	10.03			
	1.5 dCi	48		06.01				
	1.5 dCi	59		06.01	10.04			
	1.5 dCi	60		11.03				
	1.9 D	40		03.99	01.00			
	1.9 D	47		09.98				
	1.9 D (SB)	48		02.00	05.01			
1.9 dTi	59		02.00	05.01				
	1.2	43		09.98	- ABS		BAR12116	238 12,0 10,5
	1.2	44		03.99	10.03 - ABS			
	1.2	43		09.98	+ ABS		BAR20125	238 20,0 17,7 V
	1.9 D	40		03.99	01.00			
	1.9 D	47		09.98				
1.9 D (SB)	48		02.00	05.01 - ABS				
	1.5 dCi	48		06.01			BAR21106	259 20,6 17,7 V
	1.5 dCi	59		06.01	10.04			
	1.5 dCi	60		11.03				
	1.9 D (SB)	48		02.00	05.01 + ABS			
	1.9 dTi	59		02.00	05.01			
	1.2	43		09.98	- ABS		BAW1907	Rz 19,05
	1.2	44		03.99	10.03 - ABS			
	1.9 D (SJ)	47		09.98				

1) + ABS/ - air conditioning / + ABS/ - aria condizionata / + ABS/ - air conditionné / + ABS/ - aire acondicionado

















2) + ABS/ + air conditioning / + ABS/ + aria condizionata / + ABS/ + air conditionné / + ABS/ + aire acondicionado

3) - ABS/ + manual transmission / - ABS/ + scatola camb.velocità / - ABS/ + transmission mécanique / - ABS/ + cambio de velocidad

4) - ABS/ - air conditioning / - ABS/ - aria condizionata / - ABS/ - air conditionné / - ABS/ - aire acondicionado

5) + autom.transmission / + scatola cambio automatico / + transmission automatique / + cambio automático

6) + ABS/ + manual transm. / + ABS/ + scatola camb.velocità / + ABS/ + transmission mécanique / + ABS/ + cambio de velocidad

	   kW								
<b>RENAULT CLIO II Kasten (SB_) (98-)</b>									
	1.2	43	09.98	+ ABS	BAW1704			Rz 17,78	LUC
	1.5 dCi	48	06.01		BAW1707			Rz 17,78	BOS
	1.5 dCi	59	06.01	10.04					
	1.5 dCi	60	11.03						
	1.9 D	40	03.99	01.00					
	1.9 D (SB)	48	02.00	05.01					
	1.9 D (SE)	47	09.98						
	1.9 D (SR)	47	09.98						
	1.9 dTi	59	02.00	05.01					
	1.2	43	09.98	+ ABS	BAE5002			203 x 38 HEB	LUC
	1.5 dCi	48	06.01						
	1.5 dCi	59	06.01	10.04					
	1.5 dCi	60	11.03						
	1.9 D	40	03.99	01.00					
	1.9 D (SB)	48	02.00	05.01					
	1.9 D (SE)	47	09.98						
	1.9 D (SR)	47	09.98						
	1.9 dTi	59	02.00	05.01					
<b>RENAULT CLIO III (BR_/CR_) (05-)</b>									
	1.2	43	09.06		BA2284			23973 17,3 /S	LUC
	1.2	57	10.05						
	1.2 16V	48	06.05						
	1.2 16V	55	06.05						
	1.2 16V	58	06.05						
	1.2 16V	74	05.07						
	1.2 16V Hi-Flex	55	07.08						
	1.4 16V	72	06.05						
	1.5 D	60	11.07						
	1.5 dCi	48	05.05	10.06					
	1.5 dCi	50	06.05						
	1.5 dCi	63	06.05						
	1.5 dCi	76	06.05						
	1.5 dCi	78	06.05						
	1.6 16V	65	06.05						
	1.6 16V	82	06.05						
	1.6 16V GT	94	04.09						
2.0 16V	102	09.06		BA2317			24535 18,3 +	ATE	
2.0 16V	110	11.07							
	2.0 16V	102	09.06		BAR24158			280 24,0 21,8 V L	
	2.0 16V	110	11.07						
	1.2	43	09.06	+ ESP	BA2212			23554 16,4 /S	LUC
	1.2	57	10.05	+ ESP					
	1.2 16V	48	06.05	+ ESP					
	1.2 16V	55	06.05	+ ESP					
	1.2 16V	58	06.05	+ ESP					
	1.2 16V	74	05.07	+ ESP					
	1.2 16V Hi-Flex	55	07.08	+ ESP					
	1.4 16V	72	06.05	+ ESP					
	1.5 D	60	11.07	+ ESP					
	1.5 dCi	48	05.05	10.06 + ESP					
	1.5 dCi	50	06.05	+ ESP					
	1.5 dCi	63	06.05	+ ESP					
	1.5 dCi	76	06.05	+ ESP					
	1.5 dCi	78	06.05	+ ESP					
	1.6 16V	65	06.05						
	1.6 16V	82	06.05						
	1.6 16V GT	94	04.09						
2.0 16V Sport	145	02.06							
2.0 16V Sport	148	04.09							
<b>RENAULT CLIO III Grandtour (KR_) (08-)</b>									
	1.2 16V	55	02.08		BA2284			23973 17,3 /S	LUC
	1.2 16V	57	02.08						
	1.2 16V	74	02.08						
	1.2 16V Hi-Flex	55	07.08						
	1.4 16V	72	02.10						
	1.5 dCi	48	02.08						
	1.5 dCi	50	02.08						
	1.5 dCi	63	02.08						
	1.5 dCi	76	02.08						
	1.5 dCi	78	02.08						
	1.6 16V	82	02.08						
1.6 16V	94	11.08							
	1.2 16V	55	02.08	+ ESP	BA2212			23554 16,4 /S	LUC
	1.2 16V	57	02.08	+ ESP					
	1.2 16V	74	02.08	+ ESP					
	1.2 16V Hi-Flex	55	07.08	+ ESP					
	1.4 16V	72	02.10	+ ESP					
	1.5 dCi	48	02.08	+ ESP					
	1.5 dCi	50	02.08	+ ESP					
	1.5 dCi	63	02.08	+ ESP					
	1.5 dCi	76	02.08	+ ESP					
	1.5 dCi	78	02.08	+ ESP					
	1.6 16V	82	02.08	+ ESP					
1.6 16V	94	11.08	+ ESP						

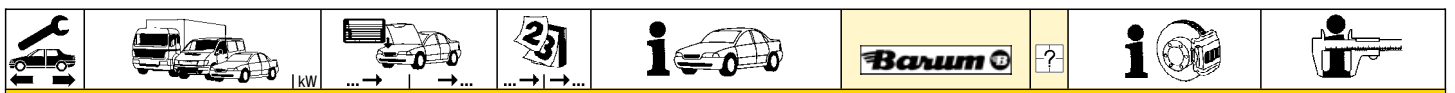

### RENAULT ESPACE II (J/S 63\_) (91-96)

	2.0 (J/- 636)	76	01.91	10.96	BA2013		20236 18,2 +/WK/S	LUC	
	2.1 RTDT Quadra	65	01.91	05.92					
	2.1 TD (J633-635,63D)	65	01.91	10.96					
	2.1 TD (J63E)	66	11.94	10.96					
	2.2 (J/S637,J63G)	79	01.91	10.96					
	2.2 4x4 (J/S637,J63G)	79	03.91	12.96					
2.8 V6 (J638,J63J)	110	01.91	10.96	BA2050		21388 18,3 +/WK/S	LUC		
	2.0 (J/- 636)	76	01.91	10.96	BAR20126		259 20,2 17,7 V		
	2.1 RTDT Quadra	65	01.91	05.92					
	2.1 TD (J633-635,63D)	65	01.91	10.96					
	2.1 TD (J63E)	66	11.94	10.96					
	2.2 (J/S637,J63G)	79	01.91	10.96					
	2.2 4x4 (J/S637,J63G)	79	03.91	12.96					
	2.0 (J/- 636)	76	01.91	10.96	BA2082		20336 14,0 +/WK	BDX	
	2.1 RTDT Quadra	65	01.91	05.92					+ ABS/ + Niveauregulierung <sup>1)</sup>
	2.1 TD (J633-635,63D)	65	01.91	10.96					+ Niveauregulierung <sup>2)</sup>
	2.1 TD (J63E)	66	11.94	10.96					+ Niveauregulierung <sup>2)</sup>
	2.2 (J/S637,J63G)	79	05.93	10.96					+ ABS/ + Niveauregulierung <sup>1)</sup>
	2.2 4x4 (J/S637,J63G)	79	05.93	12.96					+ ABS/ + Niveauregulierung <sup>1)</sup>
	2.8 V6 (J638,J63J)	110	01.91	10.96					

### RENAULT ESPACE III (JE\_) (96-02)

	1.9 dTi	72	02.99	10.02	BA2022		21888 18,0 +/WK/S	LUC
	2.0	84	11.96	10.00				
	2.0	102	09.01	10.02				
	2.0 16V	103	10.98	10.02				
	2.2 D	84	11.97	01.00				
	2.2 dT	83	11.96	10.00				
	3.0 V6	123	11.96	10.98				
	2.2 dCi	85	07.00	10.02				
	1.9 dTi	72	02.99	10.02	BAR24171		280 24,0 21,8 V L	
	2.0	84	11.96	10.00				
	2.0	102	09.01	10.02				
	2.0 16V	103	10.98	10.02				
	2.2 D	84	11.97	01.00				
	2.2 dT	83	11.96	10.00				
	3.0 V6	123	11.96	10.98				
		2.0 16V	103	10.98				
3.0 V6		123	11.96	10.98				
3.0 V6		140	10.98	06.00				
	2.0	102	09.01	10.02	BA2212		23554 16,4 /S	LUC
	2.0 16V	103	07.00	10.02				
	2.2 dCi	95	10.00	10.02				
	3.0 V6	140	07.00	10.02				
	3.0 V6	140	07.00	10.02				
	2.0	102	09.01	10.02	BAR11151		265 10,5 9,5	
	2.0 16V	103	10.98	10.02				
	2.2 dCi	95	10.00	10.02				
	3.0 V6	123	11.96	10.98				
	3.0 V6	140	10.98	10.02				

### RENAULT ESPACE IV (JK\_) (02-)

















	1.9 dCi	85	04.03	02.05	BA2238		23482 16,4 +	ATE
	1.9 dCi	88	11.02					
	2.0	98	11.02	02.05				
	2.0 dCi	96	01.06					
	2.0 dCi 110	110	01.06					
	2.0 dCi 130	127	01.06					
	2.0 i	100	11.02					
	2.0 Turbo	120	11.02					
	2.0 Turbo	125	04.05					
	2.2 dCi	102	02.06					
	2.2 dCi	110	11.02					
	3.0 dCi	130	11.02					
	3.0 dCi	133	01.06					
	3.5 V6	177	11.02					

### RENAULT EXPRESS/RAPID (F40\_) (85-98)

	1.0 (F400)	27	01.86	05.88	BA2077		21097 15,0 +/WK	BDX					
	1.1 (F401)	33	07.85	05.88					- ⊖				
	1.1 (F40H)	33	06.87	05.88									
	1.6 (F404)	40	01.86	06.86					+ ⊕				
	1.0 (F400)	27	06.88	05.92					BA2055 BA2023		20905 18,0 +/WK 21463 18,0 /WK/S	BDX LUC	
	1.1 (F401)	33	07.85	05.88									+ ⊕
	1.1 (F401)	33	06.88	04.95									
	1.1 (F40H)	33	06.88	06.90									
	1.1 (F40T)	33	09.91	03.98									
	1.2 (F406)	40	10.92	03.98									
	1.2 (F40F)	40	06.90	03.98									
	1.4 (F402)	43	01.86	06.90									
	1.4 (F40A)	43	06.90	03.98									
	1.4 (F40M)	44	06.87	06.90									
	1.4 (F40Y)	43	09.91	03.98									
	1.4 i (F407)	43	01.86	03.98									
	1.4 i (F40D)	58	09.94	03.98									

<sup>1)</sup> + ABS/ + suspens.level control / + ABS/ + correttore d'assetto / + ABS/ + correcteur d'assiette / + ABS/ + regul. alt.suspension

<sup>2)</sup> + suspension level control / + correttore assetto / + correcteur d'assiette / + regulación altura suspension

																	
<b>RENAULT EXPRESS/RAPID (F40_) (85-98)</b>																	
	1.4 i (F40U)	55		09.91	03.98			BA2055							20905	18,0 +/WK	BDX
	1.4 i (F40V)	55		09.91	03.98			BA2023							21463	18,0 /WK/S	LUC
	1.6 (F404)	40		01.86	08.98	- (F)											
	1.6 (F404)	40		07.86	08.98	+ (F)											
	1.9 (F40E)	47		09.92	03.98												
	1.9 (F40N)	47		06.90	03.98												
	1.9 (F40P)	47		09.91	03.98												
	1.9 (F40R)	40		09.94	03.98			BA2055							20905	18,0 +/WK	BDX
	1.9 D (G40B)	40		09.95	03.98												
	1.9 D (G40C)	40		09.95	03.98												
	1.0 (F400)	27		01.86	05.92	+ (D)		BAR08104							238	8,2 7,0	
	1.1 (F401)	33		07.85	05.88	- (I)											
	1.1 (F40H)	33		06.87	05.88												
	1.6 (F404)	40		01.86	06.86	+ (F)											
	1.0 (F400)	27		01.86	05.92	- (D)		BAR12116							238	12,0 10,5	
	1.1 (F401)	33		06.88	04.95	- (I)											
	1.1 (F401)	33		01.86	04.95	+ (I)											
	1.1 (F40H)	33		06.88	06.90												
	1.1 (F40T)	33		09.91	03.98												
	1.2 (F406)	40		10.92	03.98												
1.2 (F40F)	40		06.90	03.98													
1.4 (F402)	43		01.86	06.90													
1.4 (F40A)	43		06.90	03.98													
1.4 (F40M)	44		06.87	06.90													
1.4 (F40Y)	43		09.91	03.98													
1.4 i (F407)	43		01.86	03.98													
1.4 i (F40D)	58		09.94	03.98													
1.4 i (F40U)	55		09.91	03.98													
1.4 i (F40V)	55		09.91	03.98													
1.6 (F404)	40		01.86	08.98	- (F)												
1.6 (F404)	40		07.86	08.98	+ (F)												
1.9 (F40E)	47		09.92	03.98													
1.9 (F40N)	47		06.90	03.98													
1.9 (F40P)	47		09.91	03.98													
1.9 (F40R)	40		09.94	03.98													
1.9 D (G40B)	40		09.95	03.98													
1.9 D (G40C)	40		09.95	03.98													
	1.0 (F400)	27		01.86	05.92			BAE5008							180	x 42	BDX
	1.1 (F401)	33		07.85	04.95												
	1.1 (F40H)	33		06.87	06.90												
	1.1 (F40T)	33		09.91	09.96												
	1.6 (F404)	40		01.86	06.86	+ (F)											
<b>RENAULT KANGOO I (KC_) (98-07)</b>																	
	1.2	43		03.98	12.07			BA2090						- Postfahrzeug <sup>1)</sup>	21980	18,0 +/WE/S	BOS
	1.2 16V	55		06.01	12.07												
	1.4	55		03.98	12.07												
	1.5 dCi	42		07.03	12.07												
	1.5 dCi	62		06.05	12.07												
	1.5 dCi (KC07)	48		12.01	12.07												
	1.5 dCi (KC08/09)	60		07.02	12.07												
	1.6 16V 2WD	70		06.01	12.07												
	1.9 D	47		03.98	12.07												
	1.9 D (KC0D)	40		03.98	12.07												
	1.9 dTi (KC0U)	59		02.00	12.07												
	1.9 RXED	48		09.99	06.01												
	1.6 16V 4x4	70		10.01	12.07			BA2230							23930	17,5 /S	BOS
	1.9 dCi 4x4 (KC0V)	59		10.01	12.07												
		1.2	43		03.98	12.07	- ABS		BAR20125							238	20,0 17,7 V
1.4		55		03.98	12.07	- ABS/ - verstärktes Fahrwerk <sup>2)</sup>											
1.9 D		47		03.98	12.07	- ABS											
1.9 D (KC0D)		40		03.98	12.07	- ABS											
1.9 dTi (KC0U)		59		02.00	12.07	- ABS											
1.9 RXED		48		09.99	06.01	- ABS											
1.2		43		03.98	12.07	+ ABS		BAR21106							259	20,6 17,7 V	
1.2 16V		55		06.01	12.07												
1.4		55		03.98	12.07	+ ABS/ + verstärktes Fahrwerk <sup>3)</sup>											
1.5 dCi		42		07.03	12.07												
1.5 dCi		62		06.05	12.07												
1.5 dCi (KC07)		48		12.01	12.07												
1.5 dCi (KC08/09)		60		07.02	12.07												
1.6 16V 2WD		70		06.01	12.07												
1.9 D		47		03.98	12.07	+ ABS											
1.9 D (KC0D)	40		03.98	12.07	+ ABS												
1.9 dTi (KC0U)	59		02.00	12.07	+ ABS												
1.9 RXED	48		09.99	06.01	+ ABS												
1.6 16V 4x4	70		10.01	12.07			BAR24158							280	24,0 21,8 V L		
1.9 dCi 4x4 (KC0V)	59		10.01	12.07													
	1.6 16V 4x4	70		10.01	12.07			BA2225							23557	17,2 /S	BOS
	1.9 dCi 4x4 (KC0V)	59		10.01	12.07												
	1.2 (KC01/OA/OF)	43		03.98	12.07	- verstärktes Fahrwerk <sup>4)</sup>		BAW2207							Rz	22,00	
	1.2 16V (KC05/OT/OW)	55		06.01	12.07	- verstärktes Fahrwerk <sup>4)</sup>											
	1.4	55		03.98	12.07	- verstärktes Fahrwerk <sup>4)</sup>											
	1.5 dCi	42		07.03	12.07	- verstärktes Fahrwerk <sup>4)</sup>											
	1.5 dCi	62		06.05	12.07	- verstärktes Fahrwerk <sup>4)</sup>											

<sup>1)</sup> - Postal vehicle / - Veicoli postale / - Véhicule postal / - Vehículo de correos

<sup>2)</sup> - ABS/ - reinforced suspension / - ABS/ - sospensione rinforzata / - ABS/ - châssis renforcé / - ABS/ - suspensión reforzada

<sup>3)</sup> + ABS/ + reinforced suspens. / + ABS/ + sospensione rinforzata / + ABS/ + châssis renforcé / + ABS/ + suspensión reforzada



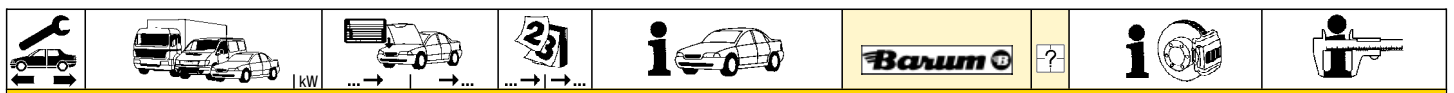

<sup>4)</sup> - reinforced suspension / - sospensione rinforzata / - châssis renforcé / - suspensión reforzada



RENAULT KANGOO I (KC_) (98-07)							
	1.5 dCi (KC07)	48	12.01	12.07	- verstärktes Fahrwerk <sup>1)</sup>	BAW2207	Rz 22,00
	1.5 dCi (KC08/09)	60	07.02	12.07	- verstärktes Fahrwerk <sup>1)</sup>		
	1.6 16V 2WD	70	06.01	12.07	- verstärktes Fahrwerk <sup>1)</sup>		
	1.9 D	47	03.98	12.07	- verstärktes Fahrwerk <sup>1)</sup>		
	1.9 D (KC0D)	40	03.98	12.07	- verstärktes Fahrwerk <sup>1)</sup>		
	1.9 dTi (KC0U)	59	02.00	12.07	- verstärktes Fahrwerk <sup>1)</sup>		
1.9 RXED	48	09.99	06.01	- verstärktes Fahrwerk <sup>1)</sup>			
	1.2 (KC01/OA/OF)	43	03.98	12.07	- verstärktes Fahrwerk <sup>1)</sup>	BAE5017	203 x 39 HEB
	1.2 16V (KC05/OT/OW)	55	06.01	12.07	- verstärktes Fahrwerk <sup>1)</sup>		
	1.4	55	03.98	12.07	- verstärktes Fahrwerk <sup>1)</sup>		
	1.5 dCi	42	07.03	12.07	- verstärktes Fahrwerk <sup>1)</sup>		
	1.5 dCi	62	06.05	12.07	- verstärktes Fahrwerk <sup>1)</sup>		
	1.5 dCi (KC07)	48	12.01	12.07	- verstärktes Fahrwerk <sup>1)</sup>		
	1.5 dCi (KC08/09)	60	07.02	12.07	- verstärktes Fahrwerk <sup>1)</sup>		
	1.6 16V 2WD	70	06.01	12.07	- verstärktes Fahrwerk <sup>1)</sup>		
	1.9 D	47	03.98	12.07	- verstärktes Fahrwerk <sup>1)</sup>		
	1.9 D (KC0D)	40	03.98	12.07	- verstärktes Fahrwerk <sup>1)</sup>		
	1.9 dTi (KC0U)	59	02.00	12.07	- verstärktes Fahrwerk <sup>1)</sup>		
	1.9 RXED	48	09.99	06.01	- verstärktes Fahrwerk <sup>1)</sup>		

RENAULT KANGOO Express/Rapid (FC_) (98-07)									
	1.0	40	07.03	12.07		BA2090	21980 18,0 +/-WE/S BOS		
	1.2	43	03.98	12.07					
	1.2	44	07.98	07.01					
	1.2 16V	55	10.01	12.07					
	1.4	55	03.98	12.07					
	1.5 dCi	42	12.02	12.07					
	1.5 dCi	50	06.05	12.07					
	1.5 dCi	62	06.05	12.07					
	1.5 dCi (FC07)	48	12.01	12.07					
	1.5 dCi (FC08/09)	60	04.03	12.07					
	1.6 16V	70	10.01	12.07					
	1.9 D	47	03.98	12.07					
	1.9 D	48	09.99	06.03					
	1.9 D (FC0D)	40	03.98	12.07					
1.9 dTi (FC0U)	59	02.00	12.07						
1.6 16V 4x4	70	10.01	12.07		BA2230	23930 17,5 /S BOS			
1.9 dCi 4x4 (FC0V)	59	10.01	12.07						
	1.0	40	07.03	12.07	- ABS	BAR20125	238 20,0 17,7 V		
	1.2	43	03.98	12.07	- ABS				
	1.2	44	07.98	07.01	- ABS				
	1.4	55	03.98	12.07	- ABS/ - verstärktes Fahrwerk <sup>2)</sup>				
	1.5 dCi	42	12.02	12.07	- ABS				
	1.5 dCi (FC07)	48	12.01	12.07	- ABS				
	1.9 D	47	03.98	12.07	- ABS				
	1.9 D (FC0D)	40	03.98	12.07	- ABS				
	1.9 dTi (FC0U)	59	02.00	12.07	- ABS				
	1.0	40	07.03	12.07				BAR21106	259 20,6 17,7 V
	1.2	43	03.98	12.07	+ ABS				
	1.2	44	07.98	07.01					
	1.2 16V	55	10.01	12.07					
	1.4	55	03.98	12.07	+ ABS/ + verstärktes Fahrwerk <sup>3)</sup>				
1.5 dCi	42	12.02	12.07	+ ABS					
1.5 dCi	50	06.05	12.07						
1.5 dCi	62	06.05	12.07						
1.5 dCi (FC07)	48	12.01	12.07						
1.5 dCi (FC08/09)	60	04.03	12.07						
1.6 16V	70	10.01	12.07						
1.9 D	47	03.98	12.07	+ ABS					
1.9 D	48	09.99	06.03	+ ABS					
1.9 D (FC0D)	40	03.98	12.07	+ ABS					
1.9 dCi 4x4 (FC0V)	59	10.01	12.07						
1.9 dTi (FC0U)	59	02.00	12.07	+ ABS					
1.6 16V 4x4	70	10.01	12.07		BAR24158	280 24,0 21,8 V L			
1.9 dCi 4x4 (FC0V)	59	10.01	12.07						
	1.6 16V 4x4	70	10.01	12.07		BA2225	23557 17,2 /S BOS		
	1.9 dCi 4x4 (FC0V)	59	10.01	12.07					
	1.0	40	07.03	12.07		BAW2207	- verstärktes Fahrwerk <sup>1)</sup> Rz 22,00		
	1.2	43	03.98	12.07					
	1.2	44	07.98	07.01					
	1.2 16V	55	10.01	12.07					
	1.4	55	03.98	12.07					
	1.5 dCi	42	12.02	12.07					
	1.5 dCi	50	06.05	12.07					
	1.5 dCi	62	06.05	12.07					
	1.5 dCi (FC07)	48	12.01	12.07					
	1.5 dCi (FC08/09)	60	04.03	12.07					
	1.6 16V	70	10.01	12.07					
	1.9 D	47	03.98	12.07					
	1.9 D	48	09.99	06.03					
	1.9 D (FC0D)	40	03.98	12.07					
1.9 dTi (FC0U)	59	02.00	12.07						

<sup>1)</sup> - reinforced suspension / - sospensione rinforzata / - châssis renforcé / - suspensión reforzada  
<sup>2)</sup> - ABS/ - reinforced suspension / - ABS/ - sospensione rinforzata / - ABS/ - châssis renforcé / - ABS/ - suspensión reforzada  
<sup>3)</sup> + ABS/ + reinforced suspens. / + ABS/ + sospensione rinforzata / + ABS/ + châssis renforcé / + ABS/ + suspensión reforzada

RENAULT KANGOO Express/Rapid (FC_) (98-07)									
	1.0	40	07.03	12.07	BAE5017		- verstärktes Fahrwerk <sup>1)</sup>	203 x 39 HEB	
	1.2	43	03.98	12.07					
	1.2	44	07.98	07.01					
	1.2 16V	55	10.01	12.07					
	1.4	55	03.98	12.07					
	1.5 dCi	42	12.02	12.07					
	1.5 dCi	50	06.05	12.07					
	1.5 dCi	62	06.05	12.07					
	1.5 dCi (FC07)	48	12.01	12.07					
	1.5 dCi (FC08/09)	60	04.03	12.07					
	1.6 16V	70	10.01	12.07					
	1.9 D	47	03.98	12.07					
	1.9 D	48	09.99	06.03					
	1.9 D (FC0D)	40	03.98	12.07					
	1.9 dTi (FC0U)	59	02.00	12.07					
RENAULT LAGUNA I Limousine (B56/556_) (93-00)									
	1.6 16V	79	11.97	03.99	BA2050			21388 18,3 +/-WK/S	LUC
	1.8	69	04.95	02.01					
	1.8 (B56A/B)	66	11.93	02.01 + ABS					
	1.8 (B56S/T/0)	66	08.95	02.01					
	1.8 16V (B563,B564)	88	04.98	03.99					
	1.9 dTi	72	10.97	03.99					
	2.0 (B56C/H/N)	83	11.93	02.01					
	2.0 (L)	70	06.95	03.99					
	2.0 16V (B56D/M)	102	05.95	02.01					
	2.2 D (B56F/2)	61	11.93	02.01 + ABS					
	2.2 dT	83	03.96	08.99					
	3.0 V6	140	03.97	08.99					
	3.0 V6 (B56E/R,B565)	123	11.93	02.01					
	1.6 16V	79	04.99	02.01	BA2219			23172 18,3 +/-WE/S	LUC
	1.8 16V (B563,B564)	88	04.99	02.01					
	1.9 dCi	79	09.99	02.01					
	1.9 dTi	72	04.99	02.01					
	2.0 (L)	70	04.99	02.01					
	2.0 (U)	80	04.99	02.01					
	2.0 16V (556A/B)	103	09.99	02.01					
	2.2 dT	83	09.99	02.01					
	3.0 V6	140	09.99	02.01					
	1.6 16V	79	11.97	02.01	BAR24158		für 4-Loch-Felge <sup>2)</sup>	280 24,0 21,8 V L	
	1.8 (B56S/T/0)	66	05.98	02.01					
	1.8 16V (B563,B564)	88	09.99	02.01					
	1.9 dCi	79	09.99	02.01					
	1.9 dTi	72	10.97	02.01					
	2.0 (L)	70	05.98	02.01					
	2.0 (U)	80	03.99	02.01					
	2.0 16V (556A/B)	103	09.99	02.01					
	2.0 16V (B56D/M)	102	05.95	02.01					
	2.2 dT	83	09.99	02.01					
	3.0 V6	140	09.99	02.01					
	1.8	69	04.95	02.01	BAR22148		für 4-Loch-Felge <sup>2)</sup>	262 22,0 19,8 V L	
	1.8 (B56A/B)	66	11.93	02.01					
	1.8 (B56S/T/0)	66	08.95	04.98					
	2.0 (B56C/H/N)	83	11.93	02.01 - Baccara					
	2.0 (L)	70	06.95	02.01 + RW/Aiize/Business					
	2.0 (L)	70	06.95	04.98 - Baccara					
	2.2 D (B56F/2)	61	11.93	02.01					
	1.8 16V (B563,B564)	88	04.98	08.99 + Initiale	BAR24171		für 5-Loch-Felge <sup>3)</sup>	280 24,0 21,8 V L	
	1.9 dTi	72	10.97	02.01					
	2.0 (L)	70	05.98	08.99 + Initiale					
	2.0 (U)	80	03.99	02.01					
	2.0 16V	103	05.95	02.01					
	2.0 16V (B56D/M)	102	05.95	02.01					
	2.2 dT	83	03.96	08.99					
	3.0 V6	140	03.97	08.99					
	3.0 V6 (B56E/R,B565)	123	11.93	02.01					
	1.8	69	04.95	06.95 + ABS	BA2107			20410 15,0 +	BRE
	1.8 (B56A/B)	66	11.93	02.01 + ABS					
	1.8 (B56S/T/0)	66	08.95	02.01 + ABS					
	2.0 (B56C/H/N)	83	11.93	06.95 + ABS/ - Baccara					
	2.0 (B56C/H/N)	83	11.93	02.01 + Baccara					
	2.0 (L)	70	06.95	02.01 + Baccara					
	2.0 (L)	70	06.95	01.97 + Initiale					
	2.0 16V (B56D/M)	102	05.95	12.97 - ABS					
	2.0 16V (B56D/M)	102	05.95	01.97 + ABS					
	2.2 D (B56F/2)	61	11.93	06.95 + ABS					
	2.2 dT	83	03.96	12.97 - ABS					
	2.2 dT	83	03.96	01.97 + ABS					
	3.0 V6 (B56E/R,B565)	123	11.93	01.97					
	1.8	69	04.95	06.95 + ABS	BAR10219		für 4-Loch-Felge <sup>2)</sup>	265 10,5 9,5	
	1.8 (B56A/B)	66	11.93	02.01 + ABS					
	1.8 (B56S/T/0)	66	08.95	02.01 + ABS					
	1.8 16V (B563,B564)	88	04.98	08.99 + Initiale					
	1.9 dCi	79	09.99	02.01					
	2.0 (B56C/H/N)	83	11.93	06.95 + ABS/ - Baccara					
	2.0 (L)	70	09.99	02.01 + Initiale					
	2.0 16V (556A/B)	103	09.99	02.01					

<sup>1)</sup> - reinforced suspension / - sospensione rinforzata / - châssis renforcé / - suspensión reforzada

<sup>2)</sup> for 4 bore wheel rim / per cerchione a 4 fori / pour jante à 4 trous / para Llantas de 4 taladros

<sup>3)</sup> for 5 bore wheel rim / per cerchione a 5 fori / pour jante à 5 trous / para Llantas de 5 taladros



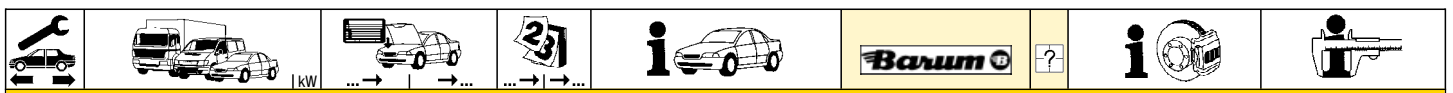

### RENAULT LAGUNA I Limousine (B56/556\_) (93-00)















	2.0 16V (B56D/M) 2.2 D (B56F/2) 2.2 dT 3.0 V6	102 61 83 140	05.95 11.93 09.99 09.99	02.01 06.95 + ABS 02.01 02.01	BAR10219	für 4-Loch-Felge <sup>1)</sup>	265 10,5 9,5
	1.6 16V 1.8 (B56S/T/0) 1.8 16V (B563,B564) 1.9 dTi 2.0 (U)	79 66 88 72 80	11.97 05.98 04.98 10.97 03.99	02.01 02.01 02.01 02.01 02.01	BAW2001		Rz 20,64 LUC
	1.6 16V 1.8 1.8 1.8 (B56A/B) 1.8 (B56S/T/0) 1.8 16V (B563,B564) 1.9 dTi 2.0 2.0 (B56C/H/N) 2.0 (B56C/H/N) 2.0 (B56C/H/N) 2.0 (L) 2.0 (U) 2.2 D (B56F/2)	79 69 69 66 66 88 72 84 83 83 83 70 80 61	11.97 04.95 07.95 11.93 08.95 04.98 08.97 11.93 11.93 07.95 07.95 07.95 03.99 11.93	02.01 06.95 - ABS 02.01 02.01 - ABS 02.01 - ABS 02.01 - Fairway/Initiale 02.01 - Concorde 06.95 - ABS 06.95 - ABS 02.01 - Baccara/Initiale 02.01 - Baccara/Initiale 02.01 - Baccara/Initiale 02.01 - Fairway 06.95 - ABS	BAE5002		203 x 38 HEB LUC

### RENAULT LAGUNA I Grandtour (K56\_) (95-00)

	1.6 16V (8) 1.8 (0) 1.8 (S) 1.8 (T) 1.8 (Z) 1.8 16V (3) 1.8 16V (4) 1.9 dTi 2.0 2.0 (C) 2.0 (H) 2.0 (L) 2.0 (N) 2.0 16V (D) 2.0 16V (M) 2.2 D 2.2 dT 3.0 V6 3.0 V6	79 66 66 66 69 88 88 72 84 83 83 70 83 102 102 66 03.96 02.96 03.97	11.97 06.95 06.95 07.95 07.95 02.99 04.98 10.97 10.98 06.95 06.95 11.95 09.95 09.95 06.95 03.96 02.96 03.97	02.01 02.01 02.01 02.01 02.01 02.01 02.01 02.01 02.01 02.01 02.01 02.01 02.01 02.01 02.01 02.01 02.01 02.01	BA2050		21388 18,3 +/-WK/S LUC
	1.6 16V (1) 1.8 16V (Y) 1.9 dCi 2.0 16V (A) 2.0 16V (B)	79 88 79 102 102	02.99 05.99 09.99 09.99 09.99	02.01 02.01 02.01 02.01 02.01	BA2219		23172 18,3 /WE/S LUC
	1.8 (0) 1.8 (S) 1.8 (T) 1.8 (Z) 2.0 2.0 (C) 2.0 (H) 2.0 (L) 2.0 (N) 2.2 D	66 66 66 69 84 83 83 70 83 83	06.95 06.95 07.95 07.95 10.98 06.95 06.95 11.95 09.95 06.95	04.98 02.01 02.01 02.01 02.01 02.01 02.01 04.98 02.01 02.01	BAR22148	für 4-Loch-Felge <sup>1)</sup>	262 22,0 19,8 V L
	1.6 16V 1.8 (0) 1.8 16V (3) 1.8 16V (4) 1.8 16V (Y) 1.9 dCi 1.9 dTi 2.0 (L) 2.0 16V (A) 2.0 16V (B) 2.2 dT 3.0 V6 3.0 V6	79 66 88 88 88 79 72 70 102 102 140 140	11.97 05.98 02.99 04.98 05.99 09.99 10.97 05.98 09.99 09.99 03.96 09.99 09.99	02.01 02.01 02.01 02.01 02.01 02.01 02.01 02.01 02.01 02.01 02.01 02.01 02.01	BAR24158	für 4-Loch-Felge <sup>1)</sup>	280 24,0 21,8 V L
	1.8 16V (4) 2.0 16V (D) 2.0 16V (M) 2.2 dT 3.0 V6 3.0 V6	88 102 102 140 140	04.98 09.95 09.95 03.96 09.99 09.99	02.01 + Fairway 02.01 02.01 02.01 02.01 08.99	BAR24171	für 5-Loch-Felge <sup>2)</sup>	280 24,0 21,8 V L
	1.8 (0) 1.8 (S) 1.8 (T) 1.8 (Z) 2.0 2.0 (C) 2.0 (H) 2.0 (L)	66 66 66 69 84 83 83 70	06.95 06.95 07.95 07.95 10.98 06.95 06.95 11.95	05.96 + ABS 05.96 + ABS 05.96 + ABS 05.96 + ABS 02.01 + ABS 05.96 + ABS 05.96 + ABS 05.96 + ABS	BA2107	für 5-Loch-Felge <sup>2)</sup>	20410 15,0 + BRE

<sup>1)</sup> for 4 bore wheel rim / per cerchione a 4 fori / pour jante à 4 trous / para Llantas de 4 taladros

















<sup>2)</sup> for 5 bore wheel rim / per cerchione a 5 fori / pour jante à 5 trous / para Llantas de 5 taladros

RENAULT LAGUNA I Grandtour (K56_) (95-00)											
											
	2.0 16V (D)	102	09.95	02.01	BA2107			20410 15,0 +	BRE		
	2.0 16V (M)	102	09.95	01.97							
	2.2 D		06.95	05.96 + ABS							
	2.2 dT		03.96	01.97							
	3.0 V6 (5)	123	03.96	02.01							
	3.0 V6 (R)	123	02.96	02.01							
	1.8 (O)	66	06.95	05.96 + ABS	BAR10219	für 4-Loch-Felge <sup>1)</sup>	265 10,5 9,5				
	1.8 (S)	66	06.95	05.96 + ABS							
	1.8 (T)	66	07.95	05.96 + ABS							
	1.8 (Z)	69	07.95	05.96 + ABS							
	2.0	84	10.98	02.01 + ABS							
	2.0 (C)	83	06.95	05.96 + ABS							
	2.0 (H)	83	06.95	05.96 + ABS							
	2.0 (L)	70	11.95	05.96 + ABS							
	2.0 16V (A)	102	09.99	02.01							
	2.0 16V (B)	102	09.99	02.01							
	2.0 16V (D)	102	09.95	02.01							
	2.2 D		06.95	05.96 + ABS							
	2.2 dT		03.96	02.01							
	3.0 V6 (5)	123	03.96	02.01							
	3.0 V6 (R)	123	02.96	02.01							
	1.8 (O)	66	06.95	05.96 - ABS	BAW2001		Rz 20,64	LUC			
	1.8 (O)	66	06.96	04.98							
	1.8 (S)	66	06.95	05.96 - ABS							
	1.8 (S)	66	06.96	02.01							
	1.8 (T)	66	07.95	05.96 - ABS							
	1.8 (T)	66	06.96	02.01							
	1.8 (Z)	69	07.95	05.96 - ABS							
	1.8 (Z)	69	06.96	02.01							
	2.0 (C)	83	06.95	05.96 - ABS							
	2.0 (C)	83	06.96	02.01							
	2.0 (H)	83	06.95	05.96 - ABS							
	2.0 (H)	83	06.96	02.01							
	2.0 (L)	70	11.95	05.96 - ABS							
	2.0 (L)	70	06.96	04.98							
	2.0 (N)	83	09.95	02.01							
	2.2 D		06.95	05.96 - ABS							
	2.2 D		06.96	02.01							
	1.6 16V	79	11.97	02.01	BAE5026		229 x 42 HEB	LUC			
	1.8 (O)	66	06.95	05.96 - ABS							
	1.8 (O)	66	06.96	02.01							
	1.8 (S)	66	06.95	05.96 - ABS							
	1.8 (S)	66	06.96	02.01							
	1.8 (T)	66	07.95	05.96 - ABS							
	1.8 (T)	66	06.96	02.01							
	1.8 (Z)	69	07.95	05.96 - ABS							
	1.8 (Z)	69	06.96	02.01							
	1.8 16V (3)	88	02.99	02.01							
	1.8 16V (4)	88	04.98	02.01 - Fairway							
	1.8 16V (Y)	88	05.99	02.01							
	1.9 dTi (KJ)	72	10.97	02.01 - Alize							
	1.9 dTi (SJ)	72	10.97	02.01							
	2.0	84	10.98	02.01							
	2.0 (C)	83	06.95	05.96 - ABS							
	2.0 (C)	83	06.96	02.01							
	2.0 (H)	83	06.95	05.96 - ABS							
	2.0 (H)	83	06.96	02.01							
	2.0 (L)	70	11.95	05.96 - ABS							
	2.0 (L)	70	06.96	02.01							
	2.0 (N)	83	09.95	02.01							
	2.2 D		06.95	05.96 - ABS							
	2.2 D		06.96	02.01							
RENAULT LAGUNA II Limousine (BG_) (01-07)											
	1.6 16V	79	03.01	06.07	BA2288	+ 16"/17"Rad/ + Leichtmetalfelgen	23245 18,2 +	ATE			
	1.6 16V	82	02.05	06.07							
	1.8 16V (04/06/0V)	89	03.01	06.07							
	1.8 16V (0B/0C/0M)	88	03.01	06.07							
	1.8 16V (0J)	85	03.01	06.07							
	1.9 dCi	79	03.01	06.07							
	1.9 dCi	81	01.05	06.07							
	1.9 dCi	96	05.05	06.07							
	1.9 dCi (08/10)	68	03.04	06.07							
	1.9 dCi (0E)	77	06.01	06.07							
	1.9 dCi (0G)	88	03.01	06.07							
	1.9 dCi (0R)	74	10.01	06.07							
	2.0 16V (00/0K/0W)	99	08.02	06.07							
	2.0 16V IDE (0N/0P)	103	04.01	06.07							
	2.2 dCi	102	05.05	06.07	BA2288		23245 18,2 +	ATE			
	2.2 dCi	110	10.01	11.01							
	2.2 dCi	110	05.05	06.07							
	1.6 16V	79	03.01	06.07	BA2238		23482 16,4 +	ATE			
	1.6 16V	82	02.05	06.07							
	1.8 16V (04/06/0V)	89	03.01	06.07							
	1.8 16V (0B/0C/0M)	88	03.01	06.07							
	1.8 16V (0J)	85	03.01	06.07							
	1.9 dCi	79	03.01	06.07							

1) for 4 bore wheel rim / per cerchione a 4 fori / pour jante à 4 trous / para Llantas de 4 taladros























2) + 16"/17" wheel / + ruota 16"/17" / + roue 16"/17" / + rueda 16"/17"

























3) + light alloy rims / + cerchione in lega / + jantes en alliage léger / + llantas de aleación

								
<b>RENAULT LAGUNA II Limousine (BG_) (01-07)</b>								
	1.9 dCi	81	01.05	06.07	BA2238			23482 16,4 + ATE
	1.9 dCi	96	05.05	06.07				
	1.9 dCi (08/10)	68	03.04	06.07				
	1.9 dCi (0E)	77	06.01	06.07				
	1.9 dCi (0G)	88	03.01	06.07				
	1.9 dCi (0R)	74	10.01	06.07				
	2.0 16V	125	01.05	06.07				
	2.0 16V (00/0K/0W)	99	08.02	06.07				
	2.0 16V IDE (0N/0P)	103	04.01	06.07				
	2.0 16V Sport	150	01.05	06.07				
	2.0 16V Turbo	120	01.03	06.07				
	2.0 dCi	110	08.05	06.07				
	2.0 dCi 130	127	01.06	06.07				
	2.2 dCi	102	05.05	06.07				
	2.2 dCi	110	10.01	06.07				
	3.0 V6	152	03.01	06.07				
<b>RENAULT LAGUNA II Grandtour (KG_) (01-07)</b>								
	1.6 16V	79	03.01	06.07	BA2288		+ 16"/17"Rad/ + Leichtmetallfelgen	23245 18,2 + ATE
	1.6 FlexFuel	76	06.01	10.03				
	1.8 16V (04/06/0V)	89	03.01	06.07				
	1.8 16V (0B/0C/0M)	88	03.01	06.07				
	1.8 16V (0J)	85	03.01	06.07				
	1.9 dCi	79	03.01	06.07				
	1.9 dCi	81	01.05	06.07				
	1.9 dCi	96	05.05	06.07				
	1.9 dCi (08/10)	68	03.04	06.07				
	1.9 dCi (0E)	77	06.01	06.07				
	1.9 dCi (0G)	88	03.01	06.07				
	1.9 dCi (0R)	74	10.01	06.07				
	2.0 16V (00/0K/0W)	99	08.02	06.07				
	2.0 16V IDE (0N/0P)	103	04.01	06.07				
	2.2 dCi	102	05.05	06.07	BA2288			23245 18,2 + ATE
	2.2 dCi	110	10.01	11.01				
	2.2 dCi	110	05.05	06.07				
	1.6 16V	79	03.01	06.07	BA2238			23482 16,4 + ATE
	1.6 FlexFuel	76	06.01	10.03				
	1.8 16V (04/06/0V)	89	03.01	06.07				
	1.8 16V (0B/0C/0M)	88	03.01	06.07				
	1.8 16V (0J)	85	03.01	06.07				
	1.9 dCi	79	03.01	06.07				
	1.9 dCi	81	01.05	06.07				
	1.9 dCi	96	05.05	06.07				
	1.9 dCi (08/10)	68	03.04	06.07				
	1.9 dCi (0E)	77	06.01	06.07				
	1.9 dCi (0G)	88	03.01	06.07				
	1.9 dCi (0R)	74	10.01	06.07				
	2.0 16V	125	01.05	06.07				
	2.0 16V (00/0K/0W)	99	08.02	06.07				
	2.0 16V IDE (0N/0P)	103	04.01	06.07				
	2.0 16V Sport	150	01.05	06.07				
	2.0 16V Turbo	120	01.03	06.07				
	2.0 dCi	110	08.05	06.07				
	2.0 dCi 130	127	01.06	06.07				
	2.2 dCi	102	05.05	06.07				
	2.2 dCi	110	10.01	06.07				
	3.0 V6	152	03.01	06.07				
<b>RENAULT LAGUNA III Limousine (BT0/1) (07-)</b>								
	1.5 dCi	81	09.07		BA2235			23482 16,4 + ATE
	1.6 16V	81	09.07					
	2.0 16V	103	09.07					
	2.0 16V Hi-Flex	103	09.07					
	2.0 16V Turbo	125	09.07					
	2.0 16V Turbo GT	150	03.08					
	2.0 dCi	96	09.07					
	2.0 dCi	110	09.07					
	2.0 dCi	127	01.08					
	2.0 dCi GT	131	03.08					
	3.0 dCi	173	09.08					
	3.5 V6	175	04.08					
<b>RENAULT LAGUNA III Coupe (DT0/1) (07-)</b>								
	2.0 16V Turbo	125	09.08		BA2235			23482 16,4 + ATE
	2.0 16V Turbo GT	150	03.08					
	2.0 dCi	110	10.07					
	2.0 dCi	127	09.08					
	2.0 dCi GT	131	03.08					
	3.0 dCi	173	09.08					
	3.5 V6	175	09.08					
<b>RENAULT LAGUNA III Grandtour (KT0/1) (07-)</b>								
	1.5 dCi	81	09.07		BA2235			23482 16,4 + ATE
	1.6 16V	81	09.07					
	2.0 16V	103	09.07					
	2.0 16V Hi-Flex	103	09.07					
	2.0 16V Turbo	125	09.07					
								

1) + 16"/17" wheel / + ruota 16"/17" / + roue 16"/17" / + rueda 16"/17"























2) + light alloy rims / + cerchione in lega / + jantes en alliage léger / + llantas de aleación

								
<b>RENAULT LAGUNA III Grandtour (KT0/1) (07-)</b>								
	2.0 16V Turbo GT 2.0 dCi 2.0 dCi 2.0 dCi 2.0 dCi GT 3.0 dCi V6 3.5 V6	150 96 110 127 131 173 175	03.08 09.07 09.07 09.07 03.08 09.08 04.08		BA2235			23482 16,4 + ATE
<b>RENAULT LOGAN (LS_) (04-)</b>								
	1.4 1.5 dCi 1.5 dCi 1.6 1.6	55 50 63 64 77	09.04 04.07 02.08 09.04 04.07		BA2023			21463 18,0 /WK/S LUC
	1.4 1.6 1.5 dCi 1.5 dCi 1.6 1.6	55 64 50 63 64 77	09.04 09.04 04.07 02.08 09.04 04.07		BAR12116 BAR12171 BAR21106	- ABS + ABS		238 12,0 10,5 259 12,0 10,6 259 20,6 17,7 V
	1.4 1.5 dCi 1.5 dCi 1.6 1.6	55 50 63 64 77	09.04 04.07 02.08 09.04 04.07		BAW1907 BAW1704			Rz 19,05 Rz 17,78 BDX LUC
	1.4 1.5 dCi 1.5 dCi 1.6 1.6	55 50 63 64 77	09.04 04.07 02.08 09.04 04.07		BAE5002			203 x 38 HEB LUC
<b>RENAULT LOGAN Kombi (KS_) (04-)</b>								
	1.4 1.5 dCi 1.5 dCi 1.6 1.6	55 50 63 64 77	10.07 04.07 02.08 04.07 04.07		BA2023			21463 18,0 /WK/S LUC
	1.4 1.6 1.5 dCi 1.5 dCi 1.6 1.6	55 64 50 63 64 77	10.07 04.07 04.07 02.08 09.04 04.07		BAR12116 BAR12171 BAR21106	- ABS + ABS		238 12,0 10,5 259 12,0 10,6 259 20,6 17,7 V
	1.4 1.5 dCi 1.5 dCi 1.6 1.6	55 50 63 64 77	10.07 04.07 02.08 04.07 04.07		BAW1907 BAW1704			Rz 19,05 Rz 17,78 BDX LUC
	1.4 1.5 dCi 1.5 dCi 1.6 1.6	55 50 63 64 77	10.07 04.07 02.08 04.07 04.07		BAE5002			203 x 38 HEB LUC
<b>RENAULT MASTER I Bus (80-98)</b>								
	2.0 2.0 2.1 D 2.2 2.4 D 2.5 D 2.5 TD 2.5 TD	58 59 44 67 52 55 69 72	10.86 07.98 08.80 09.86 08.80 07.98 08.80 07.98 08.80 08.89 08.89 07.98 08.89 07.98 08.89 07.98		BA2019			20380 15,6 +/-WK LUC
	2.0 2.0 2.1 D 2.2 2.4 D 2.5 D 2.5 TD 2.5 TD	58 59 44 67 52 55 69 72	10.86 07.98 08.80 09.86 08.80 07.98 08.80 07.98 08.80 08.89 08.89 07.98 08.89 07.98 08.89 07.98		BAW2501			Rz 25,40 LUC
<b>RENAULT MASTER I Kasten (80-98)</b>								
	2.0 2.0 2.1 D 2.2 2.4 D 2.5 D 2.5 TD 2.5 TD	58 59 44 67 52 55 69 72	10.86 07.98 08.80 09.86 08.80 07.98 08.80 07.98 08.80 08.89 08.89 07.98 08.89 07.98 08.89 07.98		BA2019			20380 15,6 +/-WK LUC
	2.0 2.0 2.1 D 2.2 2.4 D 2.5 D 2.5 TD 2.5 TD	58 59 44 67 52 55 69 72	10.86 07.98 08.80 09.86 08.80 07.98 08.80 07.98 08.80 08.89 08.89 07.98 08.89 07.98 08.89 07.98		BAW2501			Rz 25,40 LUC
↓	↓							

								
<b>RENAULT MASTER I Kasten (80-98)</b>								
	2.5 TD	72	08.89	07.98	BAW2501			Rz 25,40 LUC
<b>RENAULT MASTER I Pritsche/Fahrgestell (80-98)</b>								
	2.0 2.0 2.5 D	58 59 55	10.86 10.82 08.89	07.98 09.86 07.98	BA2019			20380 15,6 +/-WK LUC
	2.0 2.0 2.5 D	58 59 55	10.86 10.82 08.89	07.98 09.86 07.98	BAW2501			Rz 25,40 LUC
<b>RENAULT MASTER II Bus (JD/ND_) (98-06)</b>								
	1.9 dTi 2.2 dCi 90 2.5 D 2.8 dTi	59 66 59 84	09.00 09.00 07.98 07.98	10.01 10.01 01.01 07.00	BA2320			23302 18,0 /WE BDX
	1.9 dCi 80 1.9 dTi 2.2 dCi 90 2.5 dCi 100 2.5 dCi 120 2.8 dTi	60 59 66 73 84 84	11.01 11.01 11.01 10.03 10.01 08.00	08.06 08.06 08.06 08.06 08.06 10.01	BA2251			23613 17,8 BOS
	1.9 dTi 2.2 dCi 90 2.5 D 2.8 dTi	59 66 59 84	09.00 09.00 07.98 07.98	10.01 10.01 01.01 07.00	BAR24162	+ 15" Rad <sup>1)</sup>		280 24,0 21,0 V
	1.9 dCi 80 1.9 dTi 2.2 dCi 90 2.5 dCi 100 2.5 dCi 120 2.8 dTi	60 59 66 73 84 84	11.01 11.01 11.01 10.03 10.01 08.00	08.06 08.06 08.06 08.06 08.06 10.01	BAR28129	+ 16" Rad <sup>2)</sup>		306 28,0 25,0 V
	1.9 dCi 80 1.9 dTi 2.2 dCi 90 2.5 D 2.5 dCi 100 2.5 dCi 120 2.8 dTi	60 59 66 59 73 84 84	11.01 09.00 09.00 07.98 10.03 10.01 07.98	08.06 08.06 08.06 01.01 08.06 08.06 10.01	BA2261			23669 16,8 /S BOS
<b>RENAULT MASTER II Kasten (FD_) (98-06)</b>								
	1.9 dTi 2.2 dCi 90 2.5 D 2.8 dTi	59 65 59 84	09.00 09.00 07.98 07.98	10.01 10.01 01.01 07.00	BA2320			23302 18,0 /WE BDX
	1.9 dCi 80 1.9 dTi 2.2 dCi 90 2.5 dCi 100 2.5 dCi 120 2.8 dTi 3.0 dCi 120 3.0 dCi 140 3.0 dCi 160	60 59 65 73 84 84 85 100 115	11.01 11.01 11.01 10.03 10.01 08.00 06.05 10.03 06.05	08.06 08.06 08.06 08.06 08.06 10.01 08.06 08.06 08.06	BA2251			23613 17,8 BOS
	1.9 dTi 2.2 dCi 90 2.5 D 2.8 dTi	59 65 59 84	09.00 09.00 07.98 07.98	10.01 10.01 01.01 07.00	BAR24162			280 24,0 21,0 V
	1.9 dCi 80 1.9 dTi 2.2 dCi 90 2.5 dCi 100 2.5 dCi 120 2.8 dTi 3.0 dCi 120 3.0 dCi 140 3.0 dCi 160	60 59 65 73 84 84 85 100 115	11.01 11.01 11.01 10.03 10.01 08.00 06.05 10.03 06.05	08.06 08.06 08.06 08.06 08.06 10.01 08.06 08.06 08.06	BAR28129			306 28,0 25,0 V
	1.9 dCi 80 1.9 dTi 2.2 dCi 90 2.5 D 2.5 dCi 100 2.5 dCi 120 2.8 dTi 3.0 dCi 120 3.0 dCi 140 3.0 dCi 160	60 59 65 59 73 84 84 85 100 115	11.01 09.00 09.00 08.00 10.03 10.01 08.00 06.05 10.03 06.05	08.06 08.06 08.06 01.01 08.06 08.06 10.01 08.06 08.06 08.06	BA2261			23669 16,8 /S BOS
<b>RENAULT MASTER II Pritsche/Fahrgestell (ED/HD/UD_) (98-06)</b>								
	2.2 dCi 90 2.5 D 2.8 dTi	66 59 84	09.00 07.98 07.98	10.01 01.01 10.01	BA2320			23302 18,0 /WE BDX
	2.2 dCi 90 2.5 dCi 100	66 73	11.01 10.03	08.06 08.06	BA2251			23613 17,8 BOS

















<sup>1)</sup> + 15" wheel / + ruota 15" / + roue 15" / + rueda 15"

<sup>2)</sup> + 16" wheel / + ruota 16" / + roue 16" / + rueda 16"















								
<b>RENAULT MASTER II Pritsche/Fahrgestell (ED/HD/UD_) (98-06)</b>								
	2.5 dCi 120	84	10.01	08.06	BA2251			23613 17,8 BOS
	3.0 dCi 120	85	06.05	08.06				
	3.0 dCi 140	100	10.03	08.06				
	3.0 dCi 160	115	06.05	08.06				
	2.2 dCi 90	66	09.00	10.01	BAR24162			280 24,0 21,0 V
	2.5 D	59	07.98	01.01				
	2.8 dTi	84	07.98	07.00				
	2.2 dCi 90	66	11.01	08.06	BAR28129			306 28,0 25,0 V
	2.5 dCi 100	73	10.03	08.06				
	2.5 dCi 120	84	10.01	08.06				
	2.8 dTi	84	08.00	08.01				
	3.0 dCi 120	85	06.05	08.06				
	3.0 dCi 140	100	10.03	08.06				
	3.0 dCi 160	115	06.05	08.06				
	2.2 dCi 90	66	09.00	08.06	BA2261			23669 16,8 /S BOS
	2.5 D	59	08.00	01.01				
	2.5 dCi 100	73	10.03	08.06				
	2.5 dCi 120	84	10.01	08.06				
	2.8 dTi	84	08.00	10.01				
	3.0 dCi 120	85	06.05	08.06				
	3.0 dCi 140	100	10.03	08.06				
	3.0 dCi 160	115	06.05	08.06				
<b>RENAULT MASTER III Bus (JD_) (06-)</b>								
	2.5 dCi	74	08.06		BA2251			23613 17,8 BOS
	2.5 dCi	88	08.06					
	2.5 dCi	107	08.06					
	2.5 dCi	74	08.06		BAR28129			306 28,0 25,0 V
	2.5 dCi	88	08.06					
	2.5 dCi	107	08.06					
	2.5 dCi	74	08.06		BA2261			23669 16,8 /S BOS
	2.5 dCi	88	08.06					
	2.5 dCi	107	08.06					
<b>RENAULT MASTER III Kasten (FD_) (06-)</b>								
	2.5 dCi	74	08.06		BA2251			23613 17,8 BOS
	2.5 dCi	88	08.06					
	2.5 dCi	107	08.06					
	2.5 dCi	74	08.06		BAR28129			306 28,0 25,0 V
	2.5 dCi	88	08.06					
	2.5 dCi	107	08.06					
	2.5 dCi	74	08.06		BA2261			23669 16,8 /S BOS
	2.5 dCi	88	08.06					
	2.5 dCi	107	08.06					
<b>RENAULT MASTER III Pritsche/Fahrgestell (ED/HD/UD_) (06-)</b>								
	2.5 dCi	74	08.06		BA2251			23613 17,8 BOS
	2.5 dCi	88	08.06					
	2.5 dCi	107	08.06					
	2.5 dCi	74	08.06		BAR28129			306 28,0 25,0 V
	2.5 dCi	88	08.06					
	2.5 dCi	107	08.06					
	2.5 dCi	74	08.06		BA2261			23669 16,8 /S BOS
	2.5 dCi	88	08.06					
	2.5 dCi	107	08.06					
<b>RENAULT MEGANE I Limousine 3/5-türig (BA/SA_) (96-02)</b>								
	1.4 16V (D)	70	03.99	12.02	BA2023			21463 18,0 /WK/S LUC
	1.4 16V (W)	70	06.98	12.02				
	1.4 e	55	01.96	12.02				
	1.4 Eco (T)	52	01.96	03.99				
	1.6 16V (4)	79	04.98	12.02 + verstärktes Fahrwerk <sup>1)</sup>				
	1.6 e	66	01.96	03.99				
	1.6 i	55	01.96	03.99				
	1.9 D (9)	47	01.96	12.02				
	1.9 D (A)	47	01.96	12.02				
	1.9 D (R)	47	06.98	12.02				
	1.9 D (U)	47	01.96	12.02				
	1.9 dT	66	01.96	12.02				
	1.9 dTi (8)	72	03.97	02.01				
	1.9 dTi (BAON/SAON)	72	03.97	03.99				
	1.9 TDI	69	09.96	12.02				
	2.0 i		01.96	12.02				
	1.6 16V (4)	79	04.98	02.99 - verstärktes Fahrwerk <sup>2)</sup>	BA2050			21388 18,3 +/WK/S LUC
	2.0 16V	108	07.96	12.02				
	1.6 16V (11)	79	03.99	12.02	BA2219			23172 18,3 /WE/S LUC
	1.6 16V (1J)	79	03.99	12.02				
	1.6 16V (4)	79	03.99	12.02 - verstärktes Fahrwerk <sup>2)</sup>				
	1.6 16V (B)	79	03.99	12.02				
	1.8 16V	85	01.01	12.02				
	1.9 dCi		09.98	12.02				
	1.9 dTi (1U)	59	02.01	12.02				
	1.9 dTi (BAON/SAON)	72	04.99	02.01				

<sup>1)</sup> + reinforced suspension / + sospensione rinforzata / + châssis renforcé / + suspensión reforzada

<sup>2)</sup> - reinforced suspension / - sospensione rinforzata / - châssis renforcé / - suspensión reforzada

















								
<b>RENAULT MEGANE I Limousine 3/5-türig (BA/SA_) (96-02)</b>								
	1.4 e (E)	55	01.96	10.97	BAR12116			238 12,0 10,5
	1.4 Eco (T)	52	01.96	10.97				
	1.6 i	55	01.96	10.97				
	1.9 D (A/U)	47	01.96	10.97				
	1.4 e (E)	55	11.97	09.98	BAR20125			238 20,0 17,7 V
	1.4 Eco (T)	52	11.97	03.99				
	1.6 e	66	01.96	09.98				
	1.6 i	55	11.97	09.98				
	1.9 D (A)	47	11.97	09.98				
	1.9 D (U)	47	11.97	12.02				
	1.4 16V (D)	70	03.99	12.02	BAR21106			259 20,6 17,7 V
	1.4 16V (W)	70	06.98	12.02				
	1.4 e (E)	55	10.98	12.02				
	1.4 e (V)	55	06.98	12.02				
	1.6 e	66	10.98	03.99				
	1.6 i	55	10.98	03.99				
	1.9 D (9)	47	01.96	12.02				
	1.9 D (A)	47	10.98	12.02				
	1.9 D (R)	47	06.98	12.02				
	1.9 dT	66	01.96	12.02				
	1.9 dTi (8)	72	03.97	02.01				
	1.9 dTi (BAON/SAON)	72	03.97	02.99				
	1.9 TDI	69	09.96	12.02				
	2.0 i		01.96	12.02				
	2.0 16V	108	07.96	09.98	BAR22148			262 22,0 19,8 V L
	1.6 16V (11)	79	03.99	12.02	BAR24158			280 24,0 21,8 V L
	1.6 16V (1J)	79	03.99	12.02				
	1.6 16V (4)	79	04.98	12.02				
	1.6 16V (B)	79	03.99	12.02				
	1.8 16V	85	01.01	12.02				
	1.9 dCi		09.98	12.02				
	1.9 dTi (1U)	59	02.01	12.02				
	1.9 dTi (BAON/SAON)	72	03.99	02.01				
	2.0 16V	108	10.98	12.02				
	1.4 16V (D)	70	03.99	12.02 + ASR	BA2076			20973 11,0 + BDX
	1.6 16V (B)	79	03.99	12.02 + ASR				
	1.8 16V (12)	85	01.01	12.02 + ASR				
	1.8 16V (1A)	85	01.01	12.02				
	1.8 16V (1M)	85	01.01	12.02 + ASR				
	1.8 16V (1R)	85	01.01	12.02				
	1.9 dCi (F)	75	02.01	12.02 + ASR				
	2.0 16V	108	07.96	12.02				
	1.4 16V (D)	70	03.99	12.02 + ABS/ - ASR	BAW1908			Rz 19,05
	1.4 16V (W)	70	06.98	12.02 + ABS				
	1.4 e (V)	55	06.98	12.02 + ABS				
	1.6 16V (4)	79	04.98	12.02 + ABS				
	1.6 16V (B)	79	03.99	12.02 + ABS/ - ASR				
	1.8 16V (12)	85	01.01	12.02 + ABS/ - ASR				
	1.8 16V (1M)	85	01.01	12.02 + ABS/ - ASR				
	1.9 D (R)	47	06.98	12.02 + ABS				
	1.9 dCi (5)	75	09.98	12.02 + ABS				
	1.9 dCi (F)	75	02.01	12.02 + ABS/ - ASR				
	1.9 dTi (BAON/SAON)	72	03.99	02.01 + ABS				
	1.4 16V	70	06.98	12.02	BAE5022			203 x 39 BDX
	1.4 e (E)	55	01.96	12.02				
	1.4 e (V)	55	06.98	12.02				
	1.4 Eco (T)	52	01.96	03.99				
	1.6 16V (11)	79	03.99	12.02				
	1.6 16V (1J)	79	03.99	12.02				
	1.6 16V (4)	79	04.98	12.02				
	1.6 16V (B)	79	03.99	12.02				
	1.6 e	66	01.96	03.99				
	1.6 i	55	01.96	03.99				
	1.8 16V (12)	85	01.01	12.02				
	1.8 16V (1M)	85	01.01	12.02				
	1.9 D (9)	47	01.96	12.02				
	1.9 D (A)	47	01.96	12.02				
	1.9 D (R)	47	06.98	12.02				
	1.9 D (U)	47	01.96	12.02				
	1.9 dCi		09.98	12.02				
	1.9 dT	66	01.96	12.02				
	1.9 dTi (1U)	59	02.01	12.02				
	1.9 dTi (8)	72	03.97	02.01				
	1.9 dTi (BAON/SAON)	72	03.97	02.01				
	1.9 TDI	69	09.96	12.02				
	2.0 i		01.96	12.02				
<b>RENAULT MEGANE I Classic (LA_) (96-02)</b>								
	1.4 16V (0W)	70	06.98	12.02	BA2023			21463 18,0 /WK/S LUC
	1.4 e (0E)	55	09.96	12.02				
	1.4 e (0V)	55	04.98	12.02				
	1.6 16V (1C)	79	09.99	12.02				
	1.6 16V (04)	79	04.98	12.02 + verstärktes Fahrwerk <sup>1)</sup>				
	1.6 e	66	09.96	03.99				
	1.6 i	55	09.96	03.99				
	1.9 D (0A)	47	09.96	12.02				
								



















<sup>1)</sup> + reinforced suspension / + sospensione rinforzata / + châssis renforcé / + suspensión reforzada

								
<b>RENAULT MEGANE I Classic (LA_) (96-02)</b>								
	1.9 D (OR)	47	09.98	12.02		BA2023		21463 18,0 /WK/S LUC
	1.9 D (OU)	47	09.96	12.02				
	1.9 dT	66	09.96	12.02				
	1.9 dTi (1U)	59	02.01	12.02				
	1.9 dTi (08)	72	03.97	02.01				
	1.9 dTi (ON)	72	03.97	02.99				
	1.9 TDI	69	09.96	12.02				
	2.0 i (07)	84	09.96	12.02				
	2.0 i (0G)	84	09.96	02.99				
	1.6 16V (04)	79	04.98	02.99	- verstärktes Fahrwerk <sup>1)</sup>	BA2050		21388 18,3 +/WK/S LUC
	1.9 dTi (ON)	72	03.97	02.99				
	1.4 16V (0D)	70	03.99	12.02		BA2219		23172 18,3 /WE/S LUC
	1.6 16V (11)	79	03.99	12.02				
	1.6 16V (1J)	79	03.99	12.02				
	1.6 16V (04)	79	03.99	12.02	- verstärktes Fahrwerk <sup>1)</sup>			
	1.6 16V (0B)	79	03.99	12.02				
	1.8 16V	85	01.01	12.02				
	1.9 dCi	75	09.98	12.02				
	1.9 dTi (1U)	59	02.01	12.02				
	1.9 dTi (ON)	72	03.99	02.01				
	2.0 i (0G)	84	03.99	12.02				
	1.4 e (0E)	55	09.96	10.97		BAR12116		238 12,0 10,5
	1.6 i	55	09.96	10.97				
	1.9 D (0A)	47	09.96	10.97				
	1.9 D (0U)	47	09.96	10.97				
	1.4 e (0E)	55	11.97	09.98		BAR20125		238 20,0 17,7 V
	1.6 e	66	09.96	10.97				
	1.6 i	55	11.97	09.98				
	1.9 D (0A)	47	11.97	09.98				
	1.9 D (0U)	47	11.97	12.02				
	1.4 16V (0D)	70	03.99	12.02		BAR21106		259 20,6 17,7 V
	1.4 16V (0W)	70	06.98	12.02				
	1.4 e (0E)	55	10.98	12.02				
	1.4 e (0V)	55	04.98	12.02				
	1.6 16V (1C)	79	09.99	12.02				
	1.6 e	66	11.97	03.99				
	1.6 i	55	10.98	03.99				
	1.9 D (0A)	47	10.98	12.02				
	1.9 D (0R)	47	09.98	12.02				
	1.9 dT	66	09.96	12.02				
	1.9 dTi (08)	72	03.97	02.01				
	1.9 dTi (ON)	72	03.97	02.99				
	1.9 TDI	69	09.96	12.02				
	2.0 i (07)	84	09.96	12.02				
	2.0 i (0G)	84	09.96	02.99				
	1.6 16V (11)	79	03.99	12.02		BAR24158		280 24,0 21,8 V L
	1.6 16V (1J)	79	03.99	12.02				
	1.6 16V (04)	79	03.99	12.02				
	1.6 16V (0B)	79	03.99	12.02				
	1.8 16V	85	01.01	12.02				
	1.9 dCi	75	09.98	12.02				
	1.9 dTi (1U)	59	02.01	12.02				
	1.9 dTi (ON)	72	03.99	02.01				
	2.0 i (0G)	84	03.99	12.02				
	1.4 16V (0D)	70	03.99	12.02	+ ASR	BA2076		20973 11,0 + BDX
	1.6 16V (0B)	79	09.98	12.02				
	1.8 16V (12)	85	01.01	12.02	+ ASR			
	1.8 16V (1A)	85	01.01	12.02	+ ASR			
	1.8 16V (1M)	85	01.01	12.02	+ ASR			
	1.8 16V (1R)	85	01.01	12.02				
	1.9 dCi (1F)	75	02.01	12.02				
	1.4 16V (0D)	70	03.99	12.02	+ ABS/ - ASR	BAW1908		Rz 19,05
	1.4 16V (0W)	70	06.98	12.02	+ ABS			
	1.4 e (0V)	55	03.99	12.02	+ ABS			
	1.6 16V (04)	79	04.98	12.02	+ ABS			
	1.8 16V (12)	85	01.01	12.02	+ ABS/ - ASR			
	1.8 16V (1M)	85	01.01	12.02	+ ABS/ - ASR			
	1.9 dCi	75	09.98	12.02	+ ABS			
	1.9 dTi (1U)	59	02.01	12.02	+ ABS			
	1.9 dTi (08)	72	03.97	02.01	+ ABS			
	1.9 dTi (ON)	72	03.99	02.01	+ ABS			
	2.0 i (0G)	84	03.99	12.02	+ ABS			
	1.9 TDI	69	09.96	12.02		BAW2001		Rz 20,64 LUC
	1.4 16V (10)	70	03.99	12.02		BAE5022		203 x 39 BDX
	1.4 16V (1H)	70	03.99	12.02				
	1.4 16V (0D)	70	03.99	12.02				
	1.4 16V (0W)	70	06.98	12.02				
	1.4 e (0E)	55	09.96	12.02				
	1.4 e (0V)	55	04.98	12.02				
	1.6 16V (11)	79	09.99	12.02				
	1.6 16V (1C)	79	09.99	12.02				
	1.6 16V (04)	79	04.98	12.02				
	1.6 e	66	09.96	03.99				
	1.6 i	55	09.96	03.99				
	1.8 16V (12)	85	01.01	12.02				
	1.8 16V (1M)	85	01.01	12.02				

<sup>1)</sup> - reinforced suspension / - sospensione rinforzata / - châssis renforcé / - suspensión reforzada



									
<b>RENAULT MEGANE I Classic (LA_) (96-02)</b>									
	1.9 D	47	09.96	12.02	BAE5022			203 x 39	<b>BDX</b>
	1.9 dCi	75	09.98	12.02					
	1.9 dT	66	09.96	12.02					
	1.9 dTi (1U)	59	02.01	12.02					
	1.9 dTi (08)	72	03.97	02.01					
	1.9 dTi (0N)	72	03.97	02.01					
	2.0 i (07)	84	09.96	12.02					
	2.0 i (0G)	84	09.96	12.02					
<b>RENAULT MEGANE I Coach (DA_) (95-03)</b>									
	1.4 16V (0W)	70	06.98	02.03	BA2023			21463 18,0 /WK/S	<b>LUC</b>
	1.6 e	66	09.95	02.03					
	1.9 dTi	72	05.97	02.99					
	2.0 i		09.95	02.03					
	1.6 16V (04)	79	04.98	04.99	BA2050			21388 18,3 +/WK/S	<b>LUC</b>
	1.9 dTi	72	03.99	04.99					
	2.0 16V (03)	103	07.98	08.98					
	2.0 16V (0H)	108	09.95	08.98					
	1.4 16V (0D)	70	10.00	02.03	BA2219			23172 18,3 /WE/S	<b>LUC</b>
	1.6 16V	79	04.98	02.03					
	1.9 dCi		10.00	02.03					
	1.9 dTi	72	03.99	02.03					
	2.0 16V (03)	103	09.98	02.03					
	2.0 16V (0H)	108	09.98	02.03					
	2.0 16V (0P)	103	10.00	02.03					
	1.6 e	66	09.95	10.97	BAR20125			238 20,0 17,7 V	
	1.4 16V (0D)	70	10.00	02.03	BAR21106			259 20,6 17,7 V	
	1.4 16V (0W)	70	06.98	02.03					
	1.6 e	66	11.97	02.03					
	1.9 dTi	72	05.97	02.99					
	2.0 i		09.95	02.03					
	1.6 16V	79	04.98	02.03	BAR24158			280 24,0 21,8 V L	
	1.9 dCi		10.00	02.03					
	1.9 dTi	72	03.99	02.03					
	2.0 16V (03)	103	07.98	02.03					
	2.0 16V (0H)	◀108	09.98	02.03					
	2.0 16V (0H)	▶108	09.95	02.03					
	2.0 16V (0P)	103	10.00	02.03					
	2.0 16V (0H)	◀108	09.95	08.98	BAR22148			262 22,0 19,8 V L	
	1.4 16V (0D)	70	10.00	02.03 + ASR	BA2076			20973 11,0 +	<b>BDX</b>
	1.6 16V (0B)	79	10.00	02.03 + ASR					
	1.9 dCi (1F)	75	10.00	02.03 + ASR					
	2.0 16V (03)	103	07.98	02.03					
	2.0 16V (0H)	108	09.95	02.03					
	2.0 16V (0P)	103	10.00	02.03					
	1.4 16V (0D)	70	10.00	02.03 + ABS/ - ASR	BAW1908			Rz 19,05	
	1.4 16V (0W)	70	06.98	02.03 + ABS					
	1.6 16V (04)	79	04.98	02.03 + ABS					
	1.6 16V (0B)	79	10.00	02.03 + ABS/ - ASR					
	1.9 dCi (1F)	75	10.00	02.03 + ABS/ - ASR					
	1.9 dCi (05)	75	10.00	02.03 + ABS					
	1.9 dTi	72	03.99	02.03 + ABS					
	1.4 16V (0D)	70	10.00	02.03	BAE5022			203 x 39	<b>BDX</b>
	1.4 16V (0W)	70	06.98	02.03					
	1.6 16V (04)	79	04.98	02.03					
	1.6 16V (0B)	79	10.00	02.03					
	1.6 e	66	09.95	02.03					
	1.9 dCi (1F)	75	10.00	02.03					
	1.9 dCi (05)	75	10.00	02.03					
	1.9 dTi	72	05.97	02.03					
	2.0 i		09.95	02.03					
<b>RENAULT MEGANE I Cabrio (EA_) (96-03)</b>									
	1.4 16V (W)	70	06.98	10.03	BA2023			21463 18,0 /WK/S	<b>LUC</b>
	1.6 e	66	08.96	10.03					
	2.0 i		12.96	10.03					
	1.4 16V (D)	70	10.00	10.03	BA2219			23172 18,3 /WE/S	<b>LUC</b>
	1.6 16V	79	09.98	10.03					
	2.0 16V	102	01.02	10.03					
	2.0 16V (3)	103	09.98	10.03					
	2.0 16V (P)	103	10.00	10.03					
	2.0 16V (H)	108	08.96	10.03	BA2050			21388 18,3 +/WK/S	<b>LUC</b>
	1.6 e	66	08.96	10.97	BAR20125			238 20,0 17,7 V	
	1.4 16V (D)	70	10.00	10.03	BAR21106			259 20,6 17,7 V	
	1.4 16V (W)	70	06.98	10.03					
	1.6 e	66	11.97	10.03					
	2.0 i		12.96	10.03					
	1.6 16V	79	09.98	10.03	BAR24158			280 24,0 21,8 V L	
	2.0 16V	102	01.02	10.03					
	2.0 16V (3)	103	09.98	10.03					
	2.0 16V (H)	◀108	09.98	10.03					
	2.0 16V (H)	▶108	08.96	10.03					
	2.0 16V (P)	103	10.00	10.03					
	2.0 16V (H)	◀108	08.96	08.98	BAR22148			262 22,0 19,8 V L	















								
<b>RENAULT MEGANE I Cabrio (EA_) (96-03)</b>								
	1.4 16V (D)	70	10.00	10.03 + ASR	BA2076		20973 11,0 +	BDX
	1.6 16V (B)	79	10.00	10.03 + ASR				
	2.0 16V	102	01.02	10.03				
	2.0 16V (3)	103	09.98	10.03				
	2.0 16V (H)	108	08.96	10.03				
	2.0 16V (P)	103	10.00	10.03				
	1.4 16V (D)	70	10.00	10.03 + ABS/ - ASR	BAW1908		Rz 19,05	
	1.4 16V (W)	70	06.98	10.03 + ABS				
	1.6 16V (4)	79	09.98	10.03 + ABS				
	1.6 16V (B)	79	10.00	10.03 + ABS/ - ASR				
	1.4 16V (D)	70	10.00	10.03	BAE5022		203 x 39	BDX
	1.4 16V (W)	70	06.98	10.03				
	1.6 16V (4)	79	09.98	10.03				
	1.6 16V (B)	79	10.00	10.03				
	1.6 e	66	08.96	10.03				
	2.0 i		12.96	10.03				
<b>RENAULT MEGANE I Grandtour (KA_) (98-03)</b>								
	1.4 16V	70	09.98	12.03	BA2023		21463 18,0 /WK/S	LUC
	1.4 e	55	09.98	12.03				
	1.6 e	66	09.98	12.03				
	1.9 D	47	03.99	12.03				
	1.9 dTi (ON)	72	01.99	12.03	BA2050		21388 18,3 +/WK/S	LUC
	1.6 16V	79	09.98	12.03	BA2219		23172 18,3 /WE/S	LUC
	1.8 16V	85	01.01	12.03				
	1.9 dCi	75	01.01	12.03				
	1.9 dTi (1U)	59	02.01	12.03				
	1.4 16V	70	09.98	12.03	BAR21106		259 20,6 17,7 V	
	1.4 e	55	09.98	12.03				
	1.6 e	66	09.98	12.03				
	1.9 D	47	03.99	12.03				
	1.6 16V	79	09.98	12.03	BAR24158		280 24,0 21,8 V L	
	1.8 16V	85	01.01	12.03				
	1.9 dCi	75	02.01	12.03				
	1.9 dTi (1U)	59	02.01	12.03				
	1.9 dTi (ON)	72	01.99	12.03				
	1.4 16V (OD)	70	03.99	12.03	BA2212		23554 16,4 /S	LUC
	1.6 16V (04)	79	07.99	12.03				
	1.8 16V	85	01.01	12.03				
	1.9 dCi	75	02.01	12.03				
	1.9 dTi (1U)	59	02.01	12.03				
	1.9 dTi (ON)	72	07.99	02.01				
	1.4 16V (OW)	70	09.98	12.03	BAW2001		Rz 20,64	LUC
	1.4 e	55	09.98	12.03				
	1.6 16V (04)	79	09.98	06.99				
	1.6 e	66	09.98	12.03				
	1.9 D	47	03.99	12.03				
	1.9 dTi (ON)	72	01.99	06.99				
	1.4 16V (OW)	70	09.98	12.03	BAE5026		229 x 42 HEB	LUC
	1.4 e	55	09.98	12.03				
	1.6 16V (04)	79	09.98	06.99				
	1.6 e	66	09.98	12.03				
	1.9 D	47	03.99	12.03				
	1.9 dTi (ON)	72	01.99	06.99				
<b>RENAULT MEGANE II Limousine 3/5-türig (BM/CM_) (02-)</b>								
	1.5 dCi	60	11.02	09.05	BA2230		23930 17,5 /S	BOS
	1.5 dCi	63	05.05	09.05				
	1.6 16V	83	11.02	09.05				
	1.9 dCi	88	11.02	09.05				
	2.0 16V	99	11.02	09.05				
	1.4 16V	72	10.05		BA2317		24535 18,3 +	ATE
	1.5 dCi	60	10.05					
	1.5 dCi	63	10.05					
	1.5 dCi	76	01.07					
	1.5 dCi	78	05.05					
	1.6 16V	77	06.05					
	1.6 16V	83	10.05					
	1.6 FlexFuel	77	01.07					
	1.9 dCi	85	01.06					
	1.9 dCi	88	10.05					
	1.9 dCi	96	05.05					
	2.0 16V	99	10.05					
	2.0 dCi	110	09.05					
	1.5 dCi	60	11.02		BAR24158		280 24,0 21,8 V L	
	1.5 dCi	63	05.05					
	1.5 dCi	76	01.07					
	1.5 dCi	78	05.05					
	1.6 16V	77	06.05					
	1.6 16V	83	11.02					
	1.6 FlexFuel	77	01.07					
	1.9 dCi	85	01.06					
	1.9 dCi	88	11.02					
	1.9 dCi	96	05.05					
	2.0 16V	99	11.02					

**RENAULT MEGANE II Limousine 3/5-türig (BM/CM\_) (02-)**

	1.4 16V	72		11.02		BA2212		23554 16,4 /S	LUC	
	1.5 dCi	60		11.02						
	1.5 dCi	63		05.05						
	1.5 dCi	76		01.07						
	1.5 dCi	78		05.05						
	1.6 16V	77		06.05						
	1.6 16V	83		11.02						
	1.6 FlexFuel	77		01.07						
	1.9 dCi	85		01.06						
	1.9 dCi	88		11.02						
	1.9 dCi	96		05.05						
	2.0 16V	99		11.02						
	2.0 16V	169		08.06						
	2.0 16V Sport	165		05.04						
	2.0 16V Turbo	120		05.04						
	2.0 dCi	110		09.05						
	1.4 16V	72		11.02			BA2238	PR 1334	23482 16,4 +	ATE
	1.5 dCi	60		11.02						
	1.5 dCi	63		05.05						
	1.5 dCi	76		01.07						
1.5 dCi	78		05.05							
1.6 16V	77		06.05							
1.6 16V	83		11.02							
1.6 FlexFuel	77		01.07							
1.9 dCi	85		01.06							
1.9 dCi	88		11.02							
1.9 dCi	96		05.05							
2.0 16V	99		11.02							
2.0 16V	169		08.06							
2.0 16V Sport	165		05.04							
2.0 16V Turbo	120		05.04							
2.0 dCi	110		09.05							

**RENAULT MEGANE II Limousine 4-türig (LM\_) (03-)**

	1.5 dCi	60		09.03	09.05	BA2230		23930 17,5 /S	BOS
	1.5 dCi	63		05.05	09.05				
	1.5 dCi	74		02.04	09.05				
	1.5 dCi	78		05.05	09.05				
	1.6 16V	75		09.03	09.05				
	1.6 16V	77		05.05	09.05				
	1.6 16V	83		09.03	09.05				
	1.9 dCi	66		09.03	09.05				
	1.9 dCi	68		03.04	09.05				
	1.9 dCi	81		05.05	09.05				
	1.9 dCi	88		09.03	09.05				
	1.9 dCi	96		05.05	09.05				
	2.0 16V	99		09.03	09.05				
	1.5 dCi	60		10.05			BA2317		24535 18,3 +
1.5 dCi	63		10.05						
1.5 dCi	74		10.05	03.06					
1.5 dCi	76		01.07						
1.5 dCi	78		10.05						
1.6 16V	75		10.05						
1.6 16V	77		10.05						
1.6 16V	82		01.07						
1.6 16V	83		10.05						
1.9 dCi	66		10.05	12.05					
1.9 dCi	68		10.05						
1.9 dCi	81		10.05						
1.9 dCi	88		10.05						
1.9 dCi	96		10.05						
2.0 16V	99		10.05						
2.0 dCi	110		09.05						
	1.5 dCi	60		09.03		BAR24158		280 24,0 21,8 V L	
	1.5 dCi	63		05.05					
	1.5 dCi	74		02.04	03.06				
	1.5 dCi	76		01.07					
	1.5 dCi	78		05.05					
	1.6 16V	75		09.03					
	1.6 16V	77		05.05					
	1.6 16V	82		01.07					
	1.6 16V	83		09.03					
	1.9 dCi	66		09.03	12.05				
	1.9 dCi	68		03.04					
	1.9 dCi	81		05.05					
	1.9 dCi	88		09.03					
	1.9 dCi	96		05.05					
2.0 16V	99		09.03						
	1.4 16V	60		09.03	08.06	BA2212		23554 16,4 /S	LUC
	1.4 16V	72		09.03	04.07				
	1.5 dCi	60		09.03	04.07				
	1.5 dCi	63		05.05	04.07				
	1.5 dCi	74		02.04	03.06				
	1.5 dCi	76		01.07	04.07				
	1.5 dCi	78		05.05	04.07				
	1.6 16V	75		09.03	04.07				
	1.6 16V	77		05.05	04.07				
↓									

															
<b>RENAULT MEGANE II Limousine 4-türig (LM_) (03-)</b>															
	1.6 16V	82	01.07	04.07	BA2212			23554 16,4 /S	LUC						
	1.6 16V	83	09.03	04.07											
	1.9 dCi	66	09.03	12.05											
	1.9 dCi	68	03.04	04.07											
	1.9 dCi	81	05.05	04.07											
	1.9 dCi	88	09.03	04.07											
	1.9 dCi	96	05.05	04.07											
	2.0 16V	99	09.03	04.07											
	2.0 dCi	110	09.05	04.07											
	1.4 16V	60	09.03	08.06											
	1.4 16V	72	09.03												
	1.5 dCi	60	09.03												
	1.5 dCi	63	05.05												
	1.5 dCi	74	02.04	03.06											
	1.5 dCi	76	01.07												
	1.5 dCi	78	05.05												
	1.6 16V	75	09.03												
	1.6 16V	77	05.05												
	1.6 16V	82	01.07												
1.6 16V	83	09.03													
1.9 dCi	66	09.03	12.05												
1.9 dCi	68	03.04													
1.9 dCi	81	05.05													
1.9 dCi	88	09.03													
1.9 dCi	96	05.05													
2.0 16V	99	09.03													
2.0 dCi	110	09.05													
<b>RENAULT MEGANE II Coupe/Cabrio (EM_) (03-)</b>															
	1.5 dCi	63	05.05	09.05	BA2230			23930 17,5 /S	BOS						
	1.6 16V	77	06.05	09.05											
	1.6 16V	83	09.03	09.05											
	1.9 dCi	81	05.05	09.05											
	1.9 dCi	88	09.03	09.05											
	1.9 dCi	96	05.05	09.05											
	2.0 16V	99	09.03	09.05											
	1.5 dCi	63	10.05												
	1.5 dCi	76	01.07	06.09											
	1.5 dCi	78	03.06	06.08											
1.6 16V	77	10.05													
1.6 16V	82	01.07													
1.6 16V	83	10.05													
1.9 dCi	81	10.05													
1.9 dCi	85	01.06													
1.9 dCi	88	10.05													
1.9 dCi	96	10.05	02.07												
2.0 16V	99	10.05	03.07												
2.0 dCi	110	09.05													
	1.5 dCi	63	05.05		BAR24158			280 24,0 21,8 VL							
	1.5 dCi	76	01.07	06.09											
	1.5 dCi	78	03.06	06.08											
	1.6 16V	77	06.05												
	1.6 16V	82	01.07												
	1.6 16V	83	09.03												
	1.9 dCi	81	05.05												
	1.9 dCi	85	01.06												
	1.9 dCi	88	09.03												
	1.9 dCi	96	05.05	02.07											
2.0 16V	99	09.03	03.07												
	1.5 dCi	63	05.05	04.07	BA2212			23554 16,4 /S	LUC						
	1.5 dCi	76	01.07	04.07											
	1.5 dCi	78	03.06	04.07											
	1.6 16V	77	06.05	04.07											
	1.6 16V	82	01.07	04.07											
	1.6 16V	83	09.03	04.07											
	1.9 dCi	81	05.05	04.07											
	1.9 dCi	85	01.06	04.07											
	1.9 dCi	88	09.03	04.07											
	1.9 dCi	96	05.05	02.07											
	2.0 16V	99	09.03	03.07											
	2.0 16V Turbo	120	05.04	04.07											
	2.0 dCi	110	09.05	04.07											
<b>RENAULT MEGANE II Grandtour (KM_) (03-)</b>															
	1.4 16V	72	09.03	09.05	BA2230			23930 17,5 /S	BOS						
	1.5 dCi	60	09.03	09.05											
	1.5 dCi	63	05.05	09.05											
	1.5 dCi	74	02.04	09.05											
	1.5 dCi	78	05.05	09.05											
	1.6 16V	83	09.03	09.05											
	1.9 dCi	68	03.04	09.05											
	1.9 dCi	81	05.05	09.05											
	1.9 dCi	88	09.03	09.05											
	1.9 dCi	96	05.05	09.05											
	2.0 16V	99	09.03	09.05											
	1.4 16V	72	10.05												
	1.5 dCi	60	10.05	05.06											
	↓														

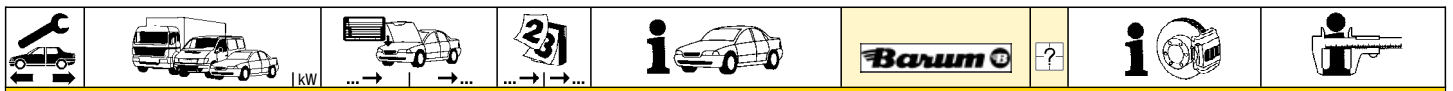

### RENAULT MEGANE II Grandtour (KM\_) (03-)













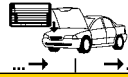



	1.5 dCi	63	10.05		BA2317		24535 18,3 +	ATE
	1.5 dCi	74	10.05	03.06				
	1.5 dCi	76	01.07					
	1.5 dCi	78	10.05	06.08				
	1.6 16V	82	01.07					
	1.6 16V	83	10.05					
	1.6 FlexFuel	77	02.08					
	1.9 dCi	68	10.05	02.07				
	1.9 dCi	81	10.05					
	1.9 dCi	88	10.05					
	1.9 dCi	96	10.05	02.07				
2.0 16V	99	10.05						
2.0 dCi	110	09.05						
	1.4 16V	72	09.03		BAR24158		280 24,0 21,8 V L	
	1.5 dCi	60	09.03	05.06				
	1.5 dCi	63	05.05					
	1.5 dCi	74	02.04	03.06				
	1.5 dCi	76	01.07					
	1.5 dCi	78	05.05	06.08				
	1.6 16V	82	01.07					
	1.6 16V	83	09.03					
	1.6 FlexFuel	77	02.08					
	1.9 dCi	68	03.04	02.07				
	1.9 dCi	81	05.05					
1.9 dCi	88	09.03						
1.9 dCi	96	05.05	02.07					
2.0 16V	99	09.03						
2.0 dCi	110	09.05	04.07					
	1.4 16V	72	09.03	04.07	BA2212		23554 16,4 /S	LUC
	1.5 dCi	60	09.03	05.06				
	1.5 dCi	63	05.05	04.07				
	1.5 dCi	74	02.04	03.06				
	1.5 dCi	76	01.07	04.07				
	1.5 dCi	78	05.05	04.07				
	1.6 16V	82	01.07	04.07				
	1.6 16V	83	09.03	04.07				
	1.9 dCi	68	03.04	02.07				
	1.9 dCi	81	05.05	04.07				
	1.9 dCi	88	09.03	04.07				
1.9 dCi	96	05.05	02.07					
2.0 16V	99	09.03	04.07					
2.0 dCi	110	09.05	04.07					

### RENAULT MEGANE SCENIC (JA\_) (96-99)

	1.4 i	51	11.96	09.98	BA2023		21463 18,0 /WK/S	LUC							
	1.6 e	66	11.96	09.98 + Schaltgetriebe 1)											
	1.6 i	55	11.96	09.98											
	1.4 i	51	10.98	09.99					BA2050		21388 18,3 +/WK/S	LUC			
	1.6 e	66	11.96	12.98 + Automatikgetriebe 2)											
	1.6 e	66	10.98	12.98 + Schaltgetriebe 1)											
	1.6 i	55	10.98	09.99											
	1.9 D (FA0J)	47	11.96	09.98											
	1.9 D (FA0Y)	47	11.96	09.99											
	1.9 D (JA0Y)	47	11.96	09.99											
	1.9 dT	66	11.96	12.97											
1.9 dTi (FA0N)	72	03.98	09.99												
1.9 dTi (JA0N)	72	04.97	09.98												
2.0 i		11.96	09.99												
1.6 e	66	01.99	09.99 + Automatikgetriebe 2)	BA2219		23172 18,3 /WE/S	LUC								
1.6 e	66	01.99	09.99 + Schaltgetriebe 1)												
1.9 D (FA0J)	47	10.98	09.99												
1.9 D (JA0J)	47	11.96	09.99												
1.9 dTi (JA0N)	72	10.98	09.99												
1.4 i	51	11.96	09.98					BAR21106		259 20,6 17,7 V					
1.6 e	66	11.96	09.98 + Schaltgetriebe 1)												
1.6 i	55	11.96	09.98												
1.6 e	66	11.96	09.98 + Automatikgetriebe 2)									BAR22148		262 22,0 19,8 V L	
1.9 D (FA0J)	47	11.96	09.98												
1.9 D (JA0J)	47	11.96	09.98												
1.9 D (FA0Y)	47	11.96	09.98												
1.9 D (JA0Y)	47	11.96	09.99												
1.9 dT	66	11.96	12.97												
1.9 dTi (FA0N)	72	03.98	09.98												
1.9 dTi (JA0N)	72	04.97	09.98												
2.0 i		11.96	09.98												
1.4 i	51	10.98	09.99	BAR24158		280 24,0 21,8 V L									
1.6 e	66	10.98	09.99												
1.6 i	55	10.98	09.99												
1.9 D (FA0J)	47	10.98	09.99												
1.9 D (JA0J)	47	10.98	09.99												
1.9 D (FA0Y)	47	10.98	09.99												
1.9 dTi (FA0N)	72	10.98	09.99												
1.9 dTi (JA0N)	72	10.98	09.99												
2.0 i		10.98	09.99												

1) + manual transmission / + scatola cambio velocità / + transmission mécanique / + cambio de velocidad

2) + autom.transmission / + scatola cambio automatico / + transmission automatique / + cambio automático

									
<b>RENAULT MEGANE SCENIC (JA_) (96-99)</b>									
	1.9 dTi (JAON)	72		04.97	09.99	+ ABS	BA2212	23554 16,4 /S	LUC
	1.4 i	51		11.96	09.99		BAW2001	Rz 20,64	LUC
	1.6 e	66		11.96	09.99				
	1.6 i	55		11.96	09.99				
	1.9 D (F/JA0J)	47		11.96	09.99				
	1.9 dT	66		11.96	09.99				
	1.9 dTi (F/JAON)	72		04.97	09.99	- ABS			
	2.0 i			11.96	09.99				
	1.4 i	51		11.96	09.99		BAE5026	229 x 42 HEB	LUC
	1.6 e	66		11.96	09.99				
	1.6 i	55		11.96	09.99				
	1.9 D (F/JA0J)	47		11.96	09.99				
	1.9 dT	66		11.96	09.99				
	1.9 dTi (F/JAON)	72		04.97	09.99	- ABS			
	2.0 i			11.96	09.99				
<b>RENAULT MODUS/GRAND MODUS (JPO_) (04-)</b>									
	1.2 16V	48		05.05			BA2284	23973 17,3 /S	LUC
	1.2 16V	55		08.04					
	1.2 16V	74		05.07					
	1.2 16V Hi-Flex	55		10.08					
	1.4 16V	72		08.04					
	1.5 dCi	50		08.04					
	1.5 dCi	60		09.05					
	1.5 dCi	63		08.04					
	1.5 dCi	76		05.07					
	1.5 dCi	78		05.05					
	1.6 16V	65		08.04					
	1.6 16V	82		08.04					
	1.2 16V	48		05.05		+ ESP	BA2212	23554 16,4 /S	LUC
	1.2 16V	55		08.04		+ ESP			
	1.2 16V	74		05.07		+ ESP			
	1.2 16V Hi-Flex	55		10.08		+ ESP			
	1.4 16V	72		08.04					
	1.5 dCi	50		08.04		+ ESP			
	1.5 dCi	60		09.05		+ ESP			
	1.5 dCi	63		08.04					
	1.5 dCi	76		05.07					
	1.5 dCi	78		05.05					
	1.6 16V	65		08.04					
	1.6 16V	82		08.04					
<b>RENAULT R19 (3/5-türig) (B53/C53/S53_) (88-95)</b>									
	1.2	40		09.88	12.95		BA2055	20905 18,0 +/WK	BDX
	1.4	43		09.88	12.95		BA2023	21463 18,0 /WK/S	LUC
	1.4 (B/C535)	55		09.94	12.95				
	1.7 (B/C536/E)			09.88	12.95				
	1.9 D (B/C/S531)	47		05.92	12.95				
	1.9 D (B/C534/J)	47		09.88	12.95	- ABS			
	1.9 D (B/C534/J)	47		10.91	12.95	+ ABS			
	1.9 D (S534/J)	47		09.88	12.95				
	1.4 (B/C53A)	59		09.90	12.95		BA2055	20905 18,0 +/WK	BDX
	1.7 (B/C53B)	54		09.88	12.95				
	1.4 (B/C53A)	59		09.90	12.95	- ABS	BA2023	21463 18,0 /WK/S	LUC
	1.4 (B/C53A)	59		09.90	12.94	+ ABS/ + Automatikgetriebe <sup>1)</sup>			
	1.4 (B/C53A)	59		09.90	12.95	+ Schaltgetriebe <sup>2)</sup>			
	1.7 (B/C53B)	54		09.88	12.95	- ABS			
	1.7 (B/C53B)	54		09.88	12.94	+ ABS/ + Automatikgetriebe <sup>1)</sup>			
	1.7 (B/C53B)	54		09.88	12.95	+ Schaltgetriebe <sup>2)</sup>			
	1.7 (B/C53M)	54		09.88	12.95				
	1.4 (B/C53A)	59		01.95	12.95	+ ABS/ + Automatikgetriebe <sup>1)</sup>	BA2023	21463 18,0 /WK/S	LUC
	1.7 (B/C533)	54		09.88	12.95				
	1.7 (B/C53B)	54		01.95	12.95	+ ABS/ + Automatikgetriebe <sup>1)</sup>			
	1.7 (B/C53C/F)			09.88	12.95				
	1.8	65		05.92	12.95				
	1.8	66		09.94	12.95				
	1.8 (B/C538)			10.91	12.95				
	1.8 16V	99		09.88	12.95				
	1.9 D (B/C534/J)	47		09.88	09.91	+ ABS			
	1.9 dT	66		09.90	12.95				
	1.9 dT (B/C53T)	66		05.92	12.95				
	1.2	40		09.88	12.95		BAR12116	238 12,0 10,5	
	1.4	43		09.88	12.95				
	1.4 (B/C535)	55		09.94	12.95				
	1.4 (B/C53A)	59		09.90	12.95	- ABS/ + Automatikgetriebe <sup>3)</sup>			
	1.4 (B/C53A)	59		09.90	12.94	+ ABS/ + Automatikgetriebe <sup>1)</sup>			
	1.4 (B/C53A)	59		09.90	12.95	+ Schaltgetriebe <sup>2)</sup>			
	1.7 (B/C536/E)			09.88	12.95				
	1.7 (B/C53B)	54		09.88	12.95	- ABS/ + Automatikgetriebe <sup>3)</sup>			
	1.7 (B/C53B)	54		09.88	12.94	+ ABS/ + Automatikgetriebe <sup>1)</sup>			
	1.7 (B/C53B)	54		09.88	12.95	+ ABS/ + Schaltgetriebe <sup>4)</sup>			
	1.9 D (B/C/S531)	47		05.92	12.95				
	1.9 D (B/C534/J)	47		09.88	12.95	- ABS			
	1.9 D (B/C534/J)	47		10.91	12.95	+ ABS			

<sup>1)</sup> + ABS/ + autom.transmission / + ABS/ + scatola cambio autom. / + ABS/ + transmission automatique / + ABS/ + cambio automático

<sup>2)</sup> + manual transmission / + scatola cambio velocità / + transmission mécanique / + cambio de velocidad

<sup>3)</sup> - ABS/ + autom.transmission / - ABS/ + scatola cambio autom. / - ABS/ + transmission automatique / - ABS/ + cambio automático

<sup>4)</sup> + ABS/ + manual transm. / + ABS/+ scatola camb.velocità / + ABS/ + transmission mécanique / + ABS/ + cambio de velocidad

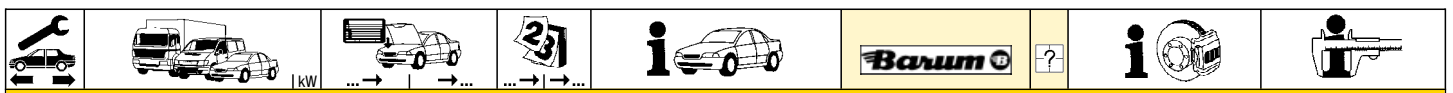

**RENAULT R19 (3/5-türig) (B53/C53/S53\_) (88-95)**

	1.9 D (S534/J)	47	09.88	12.95	BAR12116		238 12,0 10,5
	1.7 (B/C533)	54	09.88	12.95 - ABS/ + Automatikgetriebe <sup>1)</sup>	BAR20125		238 20,0 17,7 V
	1.7 (B/C533)	54	09.88	12.94 + ABS/ + Automatikgetriebe <sup>2)</sup>			
	1.7 (B/C533)	54	09.88	12.95 + Schaltgetriebe <sup>3)</sup>			
	1.7 (B/C53C)	66	09.88	12.95 - ABS/ + Automatikgetriebe <sup>1)</sup>			
	1.7 (B/C53C)	66	09.88	12.94 + ABS/ + Automatikgetriebe <sup>2)</sup>			
	1.7 (B/C53C)	66	09.88	12.95 + Schaltgetriebe <sup>3)</sup>			
	1.7 (B/C53F)	66	09.90	12.95			
	1.7 (B/C53M)	54	09.88	12.95			
	1.8 (353/535F)	79	09.94	12.94 + ABS			
	1.8 (353/535F)	66	09.94	12.95 - ABS			
	1.8 (B/C53V)	66	09.94	12.95 - ABS			
	1.8 (B/C53V)	66	09.94	12.94 + ABS			
	1.8 (B/C53Y)	65	05.92	12.95 + Schaltgetriebe <sup>3)</sup>			
	1.8 4x4 (B/C53Y)	65	05.92	12.95 - ABS			
	1.8 4x4 (B/C53Y)	65	05.92	12.94 + ABS			
	1.9 D (B/C534/J)	47	09.88	09.91 + ABS			
	1.9 dT (B/C53K)	66	09.90	12.95 - ABS			
	1.9 dT (B/C53K)	66	09.90	12.94 + ABS			
	1.9 dT (B/C53T)	66	05.92	12.95 - ABS			
	1.9 dT (B/C53T)	66	05.92	12.94 + ABS			
	1.9 dT (S53K)	66	04.91	12.95			
	1.4 (B/C53A)	59	01.95	12.95 + ABS/ + Automatikgetriebe <sup>2)</sup>	BAR21106		259 20,6 17,7 V
	1.7 (B/C533)	54	01.95	12.95 + ABS/ + Automatikgetriebe <sup>2)</sup>			
	1.7 (B/C53C)	66	01.95	12.95 + ABS/ + Automatikgetriebe <sup>2)</sup>			
	1.8 (353/535F)	66	01.95	12.95 + ABS			
	1.8 (353A/C/D)	66	09.94	12.95			
	1.8 (553A/C/D/H)	66	09.94	12.95			
	1.8 (B/C/538)	66	10.91	12.95			
	1.8 (B/C/53V)	66	01.95	12.95 + ABS			
	1.8 16V	99	09.88	12.95			
	1.8 4x4 (B/C53Y)	65	01.95	12.95 + ABS			
	1.9 dT (B/C53K)	66	01.95	12.95 + ABS			
	1.9 dT (B/C53T)	66	01.95	12.95 + ABS			
	1.2	40	09.88	12.95	BAE5008		180 x 42 BDX
	1.4	43	09.88	12.95			
	1.4	59	09.94	12.95 - ABS			
	1.4 (B/C535)	55	09.94	12.95 - ABS			
	1.7	54	09.88	12.95 - ABS			
	1.7 (B/C53C/F)	66	09.88	12.95 - ABS			
	1.8	65	05.92	12.95 - ABS			
	1.8 (353/535/A/F)	66	09.94	12.95 - ABS			
	1.8 (B/C53V)	66	09.94	12.95 - ABS			
	1.9 D (B/C534/I/J)	47	09.88	12.95 - ABS			
	1.9 D (S534/I/J)	47	09.88	12.95			
	1.9 dT (B/C53K)	66	09.90	04.92 - ABS			
	1.9 dT (S53K)	66	04.91	12.95			



















**RENAULT R19 CHAMADE (L53\_) (89-95)**

	1.2	40	06.89	12.92	BA2055		20905 18,0 +/WK BDX
	1.4	43	05.89	12.95	BA2023		21463 18,0 /WK/S LUC
	1.4	43	05.89	12.95			
	1.4 (L535)	55	09.94	12.95			
	1.7 (L536)	54	06.89	12.95			
	1.9 D (L534/J)	47	05.89	12.95 - ABS			
	1.9 D (L534/J)	47	10.91	12.95 + ABS			
	1.9 D (L53I)	47	05.92	12.95			
	1.4 (L53A)	54	09.90	12.95	BA2055		20905 18,0 +/WK BDX
	1.7 (L53B)	54	05.89	12.95			
	1.4 (L53A)	54	09.90	12.95 - ABS	BA2023		21463 18,0 /WK/S LUC
	1.4 (L53A)	54	09.90	12.95 + ABS/ + Automatikgetriebe <sup>2)</sup>			
	1.4 (L53A)	54	09.90	12.95 + Schaltgetriebe <sup>3)</sup>			
	1.7 (L533)	54	05.89	12.95			
	1.7 (L53B)	54	05.89	12.95 - ABS			
	1.7 (L53B)	54	05.89	12.95 + ABS/ + Automatikgetriebe <sup>2)</sup>			
	1.7 (L53B)	54	05.89	12.95 + Schaltgetriebe <sup>3)</sup>			
	1.7 (L53C/F)	66	05.89	12.95			
	1.8	65	05.92	12.95			
	1.8	66	11.94	12.95			
	1.8	79	05.92	12.95			
	1.8 16V	99	05.89	12.95			
	1.9 D (L534/J)	47	05.89	09.91 + ABS			
	1.9 D (L53Z)	47	05.92	12.95			
	1.9 dT	66	04.91	12.95			
	1.9 TD (L53K)	68	09.90	04.92			
	1.2	40	06.89	12.92	BAR12116		238 12,0 10,5
	1.4	43	05.89	12.95			
	1.4 (L535)	55	09.94	12.95			
	1.4 (L53A)	54	09.90	12.95 + Schaltgetriebe <sup>3)</sup>			
	1.4 (L53A)	54	09.90	12.95 - ABS/ + Automatikgetriebe <sup>1)</sup>			
	1.4 (L53A)	54	09.90	12.94 + ABS/ + Automatikgetriebe <sup>2)</sup>			
	1.7 (L536)	54	06.89	12.95			
	1.7 (L53B)	54	05.89	12.95 + Schaltgetriebe <sup>3)</sup>			
	1.7 (L53B)	54	05.89	12.95 - ABS/ + Automatikgetriebe <sup>1)</sup>			
	1.7 (L53B)	54	05.89	12.94 + ABS/ + Automatikgetriebe <sup>2)</sup>			
	1.9 D (L534/J)	47	05.89	12.95 - ABS			

<sup>1)</sup> - ABS/ + autom.transmission / - ABS/ + scatola cambio autom. / - ABS/ + transmission automatique / - ABS/ + cambio automático

















<sup>2)</sup> + ABS/ + autom.transmission / + ABS/ + scatola cambio autom. / + ABS/ + transmission automatique / + ABS/ + cambio automático

<sup>3)</sup> + manual transmission / + scatola cambio velocità / + transmission mécanique / + cambio de velocidad

										
<b>RENAULT R19 CHAMADE (L53_) (89-95)</b>										
	1.9 D (L534/J)	47		<b>10.91</b> <b>12.95</b> + ABS	<b>BAR12116</b>			238 12,0 10,5		
	1.9 D (L53I)	47		<b>05.92</b> <b>12.95</b>						
	1.7 (L533)	54		<b>05.89</b> <b>12.95</b> + Schaltgetriebe <sup>1)</sup>	<b>BAR20125</b>			238 20,0 17,7 V		
	1.7 (L533)	54		<b>05.89</b> <b>12.95</b> - ABS/ + Automatikgetriebe <sup>2)</sup>						
	1.7 (L533)	54		<b>05.89</b> <b>12.94</b> + ABS/ + Automatikgetriebe <sup>3)</sup>						
	1.7 (L53C)	66		<b>05.89</b> <b>12.95</b> + Schaltgetriebe <sup>1)</sup>						
	1.7 (L53C)	66		<b>05.89</b> <b>12.95</b> - ABS/ + Automatikgetriebe <sup>2)</sup>						
	1.7 (L53C)	66		<b>05.89</b> <b>12.94</b> + ABS/ + Automatikgetriebe <sup>3)</sup>						
	1.8	65		<b>05.92</b> <b>12.95</b> + Schaltgetriebe <sup>1)</sup>						
	1.8	65		<b>05.92</b> <b>12.95</b> - ABS/ + Automatikgetriebe <sup>2)</sup>						
	1.8	65		<b>05.92</b> <b>12.94</b> + ABS/ + Automatikgetriebe <sup>3)</sup>						
	1.8 (L53V/453F)	66		<b>09.94</b> <b>12.95</b> - ABS						
	1.8 (L53V/453F)	66		<b>09.94</b> <b>12.94</b> + ABS						
	1.9 D (L534/J)	47		<b>05.89</b> <b>09.91</b> + ABS						
	1.9 D (L53Z)	47		<b>05.92</b> <b>12.95</b> - ABS						
	1.9 D (L53Z)	47		<b>05.92</b> <b>12.94</b> + ABS						
	1.9 dT	66		<b>04.91</b> <b>12.95</b> - ABS						
	1.9 dT	66		<b>04.91</b> <b>12.94</b> + ABS						
	1.9 TD (L53K)	68		<b>09.90</b> <b>04.92</b>						
		1.4 (L53A)			<b>01.95</b> <b>12.95</b> + ABS/ + Automatikgetriebe <sup>3)</sup>	<b>BAR21106</b>				259 20,6 17,7 V
		1.7 (L533)	54		<b>01.95</b> <b>12.95</b> + ABS/ + Automatikgetriebe <sup>3)</sup>					
1.7 (L53C)		66		<b>01.95</b> <b>12.95</b> + ABS/ + Automatikgetriebe <sup>3)</sup>						
1.7 (L53F)		79		<b>09.90</b> <b>12.95</b>						
1.8		65		<b>01.95</b> <b>12.95</b> + ABS/ + Automatikgetriebe <sup>3)</sup>						
1.8		79		<b>05.92</b> <b>12.95</b>						
1.8 (L453A/C/D/H)		66		<b>09.94</b> <b>12.95</b>						
1.8 (L53V/453F)		66		<b>01.95</b> <b>12.95</b> + ABS						
1.8 16V		99		<b>05.89</b> <b>12.95</b>						
1.9 D (L53Z)		47		<b>01.95</b> <b>12.95</b> + ABS						
1.9 dT		66		<b>01.95</b> <b>12.95</b> + ABS						
	1.2	40		<b>06.89</b> <b>12.92</b>	<b>BAE5008</b>			180 x 42 <b>BDX</b>		
	1.4			<b>05.89</b> <b>12.95</b>						
	1.4	43		<b>05.89</b> <b>12.95</b>						
	1.4	55		<b>09.94</b> <b>12.95</b> - ABS						
	1.7 (L533/536)	54		<b>05.89</b> <b>12.95</b> - ABS						
	1.7 (L53C)	66		<b>05.89</b> <b>12.95</b> - ABS						
	1.8	65		<b>05.92</b> <b>12.95</b> - ABS						
	1.8 (L53V/453A/F)	66		<b>09.94</b> <b>12.95</b> - ABS						
	1.9 D (L534/I/J)	47		<b>05.89</b> <b>12.95</b> - ABS						
	1.9 dT	66		<b>04.91</b> <b>04.92</b> - ABS						
<b>RENAULT R19 Cabriolet (D53_) (91-96)</b>										
	1.7			<b>02.91</b> <b>08.96</b>	<b>BA2023</b>			21463 18,0 /WK/S <b>LUC</b>		
	1.8	65		<b>04.92</b> <b>12.94</b>						
	1.8	66		<b>01.93</b> <b>12.94</b>						
	1.8	79		<b>09.94</b> <b>08.96</b>						
	1.8 16V			<b>02.91</b> <b>03.95</b>						
	1.7			<b>02.91</b> <b>08.96</b> - ABS/ + Automatikgetriebe <sup>2)</sup>	<b>BAR20125</b>			238 20,0 17,7 V		
	1.7			<b>02.91</b> <b>12.94</b> + ABS/ + Automatikgetriebe <sup>3)</sup>						
	1.7			<b>02.91</b> <b>08.96</b> + Schaltgetriebe <sup>1)</sup>						
	1.8	65		<b>04.92</b> <b>12.94</b> - ABS/ + Automatikgetriebe <sup>2)</sup>						
	1.8	65		<b>04.92</b> <b>12.94</b> + ABS/ + Automatikgetriebe <sup>3)</sup>						
	1.8	65		<b>04.92</b> <b>12.94</b> + Schaltgetriebe <sup>1)</sup>						
	1.8 (853A)	66		<b>01.93</b> <b>08.96</b> - ABS						
	1.7			<b>01.95</b> <b>08.96</b> + ABS/ + Automatikgetriebe <sup>3)</sup>	<b>BAR21106</b>			259 20,6 17,7 V		
	1.8	66		<b>01.93</b> <b>08.96</b> + ABS						
	1.8	79		<b>09.94</b> <b>08.96</b>						
	1.8 16V			<b>02.91</b> <b>03.95</b>						
	1.7			<b>02.91</b> <b>08.96</b> - ABS	<b>BAE5008</b>			180 x 42 <b>BDX</b>		
	1.8	65		<b>04.92</b> <b>12.94</b> - ABS						
	1.8	66		<b>01.93</b> <b>08.96</b> - ABS						
<b>RENAULT R21 NEVADA (K48_) (86-95)</b>										
	1.7 (K/S 481)	55		<b>07.86</b> <b>12.95</b>	<b>BA2055</b>			20905 18,0 +/WK <b>BDX</b> 21463 18,0 /WK/S <b>LUC</b>		
	1.7 i (K 48F)	54		<b>07.86</b> <b>12.95</b>	<b>BA2023</b>					
	1.9 D (K 48I)	47		<b>04.92</b> <b>12.95</b>						
	1.9 D (K/S 48H)	47		<b>05.89</b> <b>12.95</b>						
	1.6 (U)			<b>06.88</b> <b>12.95</b>	<b>BA2023</b>					
	1.7 (K 484)			<b>06.90</b> <b>12.95</b>						
	1.7 (K 48J)			<b>07.86</b> <b>12.95</b>						
	1.7 (K 48M)	54		<b>10.87</b> <b>12.95</b>						
	1.7 (K 48N)	64		<b>10.87</b> <b>12.95</b>						
	1.7 (K/S 482)	65		<b>07.86</b> <b>12.95</b>						
1.7 i (K 48E)			<b>07.86</b> <b>12.95</b>							
	2.0 i (K 483)	85		<b>07.86</b> <b>12.95</b>	<b>BA2060</b>			21016 17,0 +/WK <b>BDX</b>		
	2.0 i (K 48C)	88		<b>06.90</b> <b>12.95</b>						
	2.0 i (K 48R)	99		<b>07.91</b> <b>12.95</b>						
	2.1 D (K 480)	51		<b>04.92</b> <b>12.95</b>						
	2.1 D (K/S 486)			<b>07.86</b> <b>12.95</b>						
	2.1 D (K/S 480)	53		<b>04.92</b> <b>12.95</b>						
	2.1 D (K/S 48V)	53		<b>05.89</b> <b>12.95</b>						
	2.1 TD (K 487)	65		<b>06.91</b> <b>12.95</b>						
	2.1 TD (K 488)	65		<b>07.86</b> <b>12.95</b>						
	2.1 TD (K 48A)	65		<b>04.92</b> <b>12.95</b>						
	2.1 TD (K 48P)	65		<b>06.90</b> <b>12.95</b>						
	2.1 TD (K 48W)	65		<b>05.89</b> <b>12.95</b>						



















1) + manual transmission / + scatola cambio velocità / + transmission mécanique / + cambio de velocidad  
2) - ABS/ + autom.transmission / - ABS/ + scatola cambio autom. / - ABS/ + transmission automatique / - ABS/ + cambio automático  
3) + ABS/ + autom.transmission / + ABS/ + scatola cambio autom. / + ABS/ + transmission automatique / + ABS/ + cambio automático



















								
<b>RENAULT R21 NEVADA (K48_) (86-95)</b>								
	2.2 i (K 48B)	79	04.93	12.95	BA2060			21016 17,0 +WK BDX
	2.2 i (K 48K)	79	07.86	12.95				
	2.2 i (K 48S)	79	06.88	12.95				
	1.6 (U)		06.88	12.95	BAR20125			238 20,0 17,7 V
	1.7 (K 484)		06.90	12.95				
	1.7 (K 48J)		07.86	12.95				
	1.7 (K 48M)	54	10.87	12.95				
	1.7 (K 48N)	64	10.87	12.95				
	1.7 (K/S 481)	55	07.86	12.95				
	1.7 (K/S 482)	65	07.86	12.95				
	1.7 i (K 48E)		07.86	12.95				
	1.7 i (K 48F)	54	07.86	12.95				
	1.9 D (K 48I)	47	04.92	12.95				
	1.9 D (K/S 48H)	47	05.89	12.95				
	1.6 (U)		06.88	12.95	BAH0024	2		L=240
	1.7 (K 482)	65	07.86	12.95				
	1.7 (K 484)		06.90	12.95				
	1.7 (K 48J)		07.86	12.95				
	1.7 (K 48M)	54	10.87	12.95				
	1.7 (K 48N)	64	10.87	12.95				
	1.7 (K/S 481)	55	07.86	12.95				
	1.7 (S 482)	65	07.86	12.95				
	1.7 i (K 48E)		07.86	12.95				
	1.7 i (K 48F)	54	07.86	12.95				
	1.9 D (K 48I)	47	04.92	12.95				
	1.9 D (K/S 48H)	47	05.89	12.95				
	2.0 i (K 483)	85	07.86	12.95 + ABS	BA2082			20336 14,0 +WK BDX
	2.0 i (K 48C)	88	06.90	12.95 + ABS	BA2107			20410 15,0 + BRE
	2.0 i (K 48R)	99	07.91	12.95				
	2.1 D (K 480)	51	04.92	12.95 + ABS				
	2.1 TD (K 487)	65	06.91	12.95 + ABS				
	2.2 i (K 48B)	79	04.93	12.95 + ABS				
	2.2 i (K 48K)	79	07.86	12.95 + ABS				
<b>RENAULT SAFRANE (B54_) (92-00)</b>								
	2.0 i (B540)	77	09.92	07.96	BA2050			21388 18,3 +WK/S LUC
	2.0 i (B542)	97	04.92	07.96				
	2.0 i (B54L)	100	08.96	12.00				
	2.1 dT	65	11.93	07.96				
	2.2 dT	83	08.96	12.00				
	2.2 i (B541)	79	04.92	07.96				
	2.2 i (B543)	101	04.92	07.96				
	2.5 20V	121	08.96	12.00				
	2.5 dT	83	12.92	07.96				
	3.0 V6	123	08.96	12.00				
	3.0 V6 (B544/B/J)	123	12.92	07.96				
	3.0 V6	140	03.99	12.00	BA2219			23172 18,3 /WE/S LUC
	2.0 i (B540)	77	09.92	07.96	BAR22148			262 22,0 19,8 V L
	2.0 i (B542/E)	97	04.92	01.95				
	2.1 dT	65	11.93	07.96				
	2.2 i (B541)	79	02.95	07.96				
	2.2 i (B541)	79	04.92	01.95				
	2.2 i (B543)	101	04.92	01.95				
	2.0 i (B54L)	100	01.98	12.00	BAR24171			280 24,0 21,8 V L
	2.2 dT	83	08.96	12.00				
	2.5 20V	121	08.96	12.00				
	2.5 dT	83	07.93	07.96 + Automatikgetriebe <sup>1)</sup>				
	2.5 dT	83	06.94	07.96 + Schaltgetriebe <sup>2)</sup>				
	3.0 V6	123	08.96	12.00				
	3.0 V6 (B544/B/J)	123	12.92	07.96				
	3.0 V6	140	03.99	12.00	BAR24171			280 24,0 21,8 V L
	2.0 i (B540)	77	09.92	01.95 + ABS	BA2107			20410 15,0 + BRE
	2.0 i (B540)	77	02.95	07.96				
	2.0 i (B542/E)	97	04.92	07.96				
	2.0 i (B54L)	100	08.96	12.00				
	2.1 dT	65	11.93	01.95 + ABS				
	2.1 dT	65	02.95	07.96				
	2.2 dT	83	08.96	12.00				
	2.2 i (B541)	79	04.92	01.95 + ABS				
	2.2 i (B541)	79	02.95	07.96				
	2.2 i (B543)	101	04.92	07.96				
	2.5 20V	121	08.96	12.00				
	2.5 dT	83	12.92	07.96				
	3.0 V6	123	08.96	12.00				
	3.0 V6	140	03.99	12.00				
	3.0 V6 (B544)	123	12.92	07.96				
	3.0 V6 (B54B/J)	123	12.92	07.96				
	2.0 i (B540)	77	09.92	01.95 + ABS	BAR10219			265 10,5 9,5
	2.0 i (B540)	77	02.95	07.96				
	2.0 i (B542/E)	97	04.92	01.95				
	2.1 dT	65	11.93	01.95 + ABS				
	2.1 dT	65	02.95	07.96				
	2.2 i (B541)	79	04.92	01.95 + ABS				
	2.2 i (B541)	79	02.95	07.96				
	2.2 i (B543)	101	04.92	01.95				



















<sup>1)</sup> + autom.transmission / + scatola cambio automatico / + transmission automatique / + cambio automático





















<sup>2)</sup> + manual transmission / + scatola cambio velocità / + transmission mécanique / + cambio de velocidad

								
<b>RENAULT SANDERO (BS0_) (09-)</b>								
	1.4	55	02.09		BA2023			21463 18,0 /WK/S LUC
	1.6	62	11.10					
	1.6	64	02.09					
	1.6	66	05.09					
	1.4	55	02.09	- ABS	BAR12116		- belüftete Scheiben <sup>1)</sup>	238 12,0 10,5
	1.6	62	11.10	- ABS				
	1.6	64	02.09	- ABS				
	1.6	66	05.09	- ABS				
	1.4	55	02.09	+ ABS	BAR12171		- belüftete Scheiben <sup>1)</sup>	259 12,0 10,6
	1.6	62	11.10	+ ABS				
	1.6	64	02.09	+ ABS				
	1.6	66	05.09	+ ABS				
	1.4	55	02.09		BAR21106		+ belüftete Scheiben <sup>2)</sup>	259 20,6 17,7 V
	1.6	62	11.10					
	1.6	64	02.09					
	1.6	66	05.09					
	1.4	55	02.09		BAW1704			Rz 17,78 LUC
	1.6	62	11.10					
	1.6	64	02.09					
	1.6	66	05.09					
	1.4	55	02.09		BAW1907		- ABS	Rz 19,05 BDX
	1.6	62	11.10					
	1.6	64	02.09					
	1.6	66	05.09					
	1.4	55	02.09		BAW1707		+ ABS	Rz 17,78 BOS
	1.6	64	11.10					
	1.6	64	02.09					
	1.6	66	05.09					
	1.4	55	02.09		BAE5002			203 x 38 HEB LUC
	1.6	62	11.10					
	1.6	64	02.09					
	1.6	66	05.09					
<b>RENAULT SCENIC I (JA_) (99-03)</b>								
	1.4 16V (OD,1H,0W,10)	70	09.99	06.03	BA2219			23172 18,3 /WE/S LUC
	1.6 16V (JA0B,04,11)	79	09.99	06.03				
	1.8 16V (12,1R,1M,1A)	85	01.01	06.03				
	1.9 dCi (JA01,05,1F)	75	09.99	06.03				
	1.9 dCi RX4	75	11.00	06.03				
	1.9 dTi	47	09.99	03.01				
	2.0 16V (1B,1D,0C)	102	06.00	06.03				
	2.0 16V IDE	103	09.99	06.03				
	2.0 16V RX4	102	06.00	06.03				
	1.4 16V (OD,1H,0W,10)	70	09.99	06.03	BAR24158			280 24,0 21,8 V L
	1.6 16V (JA0B,04,11)	79	09.99	06.03				
	1.8 16V (12,1R,1M,1A)	85	01.01	06.03				
	1.9 dCi (JA01,05,1F)	75	09.99	06.03				
	1.9 dTi	47	09.99	03.01				
	2.0 16V (1B,1D,0C)	102	06.00	06.03				
	2.0 16V IDE	103	09.99	06.03				
	1.9 dCi RX4	75	11.00	02.02	BAR24171			280 24,0 21,8 V L
	2.0 16V RX4	102	06.00	02.02				
	1.4 16V (OD,1H,0W,10)	70	09.99	06.03	BA2212		+ ABS	23554 16,4 /S LUC
	1.6 16V (JA0B,04,11)	79	09.99	06.03			+ ABS	
	1.8 16V (12,1R,1M,1A)	85	01.01	06.03				
	1.9 dCi (JA01,05,1F)	75	09.99	06.03				
	1.9 dTi (JA0N)	72	09.99	06.03			+ ABS	
	1.9 dTi (JA1U)	59	01.01	06.03				
	2.0 16V (1B,1D,0C)	102	06.00	06.03				
	2.0 16V IDE	103	09.99	06.03				
	1.4 16V (OD,1H,0W,10)	70	09.99	06.03	BAW2001		- ABS	Rz 20,64 LUC
	1.6 16V (JA0B,04,11)	79	09.99	06.03			- ABS	
	1.9 dTi (JA0N)	72	09.99	06.03			- ABS	
	1.4 16V (OD,1H,0W,10)	70	09.99	06.03	BAE5026		- ABS	229 x 42 HEB LUC
	1.6 16V (JA0B,04,11)	79	09.99	06.03			- ABS	
	1.9 dTi (JA0N)	72	09.99	06.03			- ABS	
<b>RENAULT SCENIC II (JM_) (03-09)</b>								
	1.4 16V	72	06.03	09.05	BA2230			23930 17,5 /S BOS
	1.5 dCi	60	06.03	09.05				
	1.5 dCi	63	05.05	09.05				
	1.5 dCi	74	11.03	09.05				
	1.5 dCi	78	05.05	09.05				
	1.6 16V	83	06.03	09.05				
	1.6 Hi-Flex	81	03.05	09.05				
	1.9 dCi	81	05.05	09.05				
	1.9 dCi	88	06.03	09.05				
	1.9 dCi	92	06.03	09.05				
	1.9 dCi	96	05.05	09.05				
	2.0 16V	99	06.03	09.05				
	1.4 16V	72	10.05	03.09	BA2317			24535 18,3 + ATE
	1.5 dCi	60	10.05	03.09				
	1.5 dCi	63	10.05	03.09				
	1.5 dCi	74	10.05	03.09				
	1.5 dCi	76	01.07	03.09				























<sup>1)</sup> - ventilated discs / - dischi ventilati / - disques ventilés / - disco ventilado  
<sup>2)</sup> + ventilated discs / + dischi ventilati / + disques ventilés / + disco ventilado

														
<b>RENAULT SCENIC II (JM_) (03-09)</b>														
	1.5 dCi	78		10.05	03.09	BA2317		24535 18,3 +	ATE					
	1.6 16V	77		06.06	03.09									
	1.6 16V	82		01.07	03.09									
	1.6 16V	83		10.05	03.09									
	1.6 Hi-Flex	81		10.05	03.09									
	1.9 D	85		06.06	03.09					BA2316		23245 18,3 +	ATE	
	1.9 dCi	81		10.05	03.09									
	1.9 dCi	88		10.05	03.09									
	1.9 dCi	92		10.05	03.09									
	1.9 dCi	96		10.05	03.09									
2.0 16V	99		10.05	03.09										
2.0 dCi	110		09.05	03.09										
	1.4 16V	72		06.03	03.09	BAR24158		280 24,0 21,8 V L						
	1.5 dCi	60		06.03	03.09									
	1.5 dCi	63		05.05	03.09									
	1.5 dCi	74		11.03	03.09									
	1.5 dCi	76		01.07	03.09									
	1.5 dCi	78		05.05	03.09									
	1.6 16V	77		06.06	03.09									
	1.6 16V	82		01.07	03.09									
	1.6 16V	83		06.03	03.09									
	1.6 Hi-Flex	81		03.05	03.09									
	1.4 16V	72		06.03	03.09	BA2212		23554 16,4 /S	LUC					
	1.5 dCi	60		06.03	03.09									
	1.5 dCi	63		05.05	03.09									
	1.5 dCi	74		11.03	03.09									
	1.5 dCi	76		01.07	03.09									
	1.5 dCi	78		05.05	03.09									
	1.6 16V	77		06.06	03.09									
	1.6 16V	82		01.07	03.09									
	1.6 16V	83		06.03	03.09									
	1.6 Hi-Flex	81		03.05	03.09									
	1.9 D	85		06.06	03.09									
	1.9 dCi	81		05.05	03.09									
	1.9 dCi	88		06.03	03.09									
	1.9 dCi	92		06.03	03.09									
	1.9 dCi	96		05.05	03.09									
	2.0 16V	99		06.03	03.09									
2.0 16V Turbo	120		05.04	03.09										
2.0 dCi	110		09.05	03.09										
<b>RENAULT GRAND SCENIC (JM_) (04-09)</b>														
	1.5 dCi	74		04.04	09.05	BA2230		23930 17,5 /S	BOS					
	1.6	83		04.04	09.05									
	1.9 dCi	81		05.05	09.05									
	1.9 dCi	88		04.04	09.05									
	1.9 dCi	96		05.05	09.05									
	2.0 16V	99		04.04	09.05									
	1.5 dCi	74		10.05	03.09	BA2316		23245 18,3 +	ATE					
	1.5 dCi	76		03.08	03.09									
	1.5 dCi	78		08.07	03.09									
	1.6	77		06.06	03.09									
	1.6	82		07.06	03.09									
	1.6	83		10.05	03.09									
	1.9 dCi	81		10.05	03.09									
	1.9 dCi	88		10.05	03.09									
	1.9 dCi	96		10.05	03.09									
	2.0 16V	99		10.05	03.09									
		1.5 dCi	74		04.04					03.09	BA2212		23554 16,4 /S	LUC
		1.5 dCi	76		03.08					03.09				
1.5 dCi		78		08.07	03.09									
1.6		77		06.06	03.09									
1.6		82		07.06	03.09									
1.6		83		04.04	03.09									
1.9 dCi		81		05.05	03.09									
1.9 dCi		88		04.04	03.09									
1.9 dCi		96		05.05	03.09									
2.0 16V		99		04.04	03.09									
2.0 16V Turbo	120		04.04	03.09										
<b>RENAULT THALIA (LB_) (98-)</b>														
	1.2	43		02.98	10.03	BA2023		21463 18,0 /WK/S	LUC					
	1.2 16V	55		04.02										
	1.4	55		08.00										
	1.4 16V	72		08.00										
	1.5 dCi	47		06.05										
	1.5 dCi	48		04.02										
	1.5 dCi	50		02.03										
	1.5 dCi	60		06.01										
	1.5 dCi RT	59		06.01	10.03									
	1.6	66		03.98	05.01									
	1.6 16V	79		04.02										
	1.9 D	48		02.98	05.01									
	2.0	124		09.01	10.05					BA2219		23172 18,3 /WE/S	LUC	























									
<b>RENAULT THALIA (LB_) (98-)</b>									
	1.2 16V	55	04.02			BAR12116		238 12,0 10,5	
	1.4	55	08.00						
	1.2	43	02.98	10.03		BAR20125		238 20,0 17,7 V	
	1.2 16V	55	04.02						
	1.4 16V	72	08.00						
	1.5 dCi	47	06.05						
	1.5 dCi	48	04.02						
	1.5 dCi	50	02.03						
	1.5 dCi	60	06.01						
	1.5 dCi RT	59	06.01	10.03					
1.6	66	03.98	05.01						
1.9 D	48	02.98	05.01						
1.6 16V	79	04.02				BAR21106		259 20,6 17,7 V	
2.0	124	09.01	10.05			BAR24158		280 24,0 21,8 V L	
	2.0	124	09.01	10.05		BA2076		20973 11,0 + BDX	
	1.4	55	08.00			BAW1907		Rz 19,05 BDX	
	1.2 16V	55	04.02			BAW1704		Rz 17,78 LUC	
	1.4 16V	72	08.00		- ABS				
	1.5 dCi	47	06.05						
	1.5 dCi	48	04.02						
	1.5 dCi	50	02.03						
	1.5 dCi	60	06.01						
	1.5 dCi RT	59	06.01	10.03					
	1.6	66	03.98	05.01					
	1.6 16V	79	04.02						
	1.9 D	48	02.98	05.01					
	1.2	43	02.98	10.03			BAW1707		Rz 17,78 BOS
	1.2 16V	55	04.02						
	1.4 16V	72	08.00		+ ABS				
	1.5 dCi	47	06.05						
1.5 dCi	48	04.02							
1.5 dCi	50	02.03							
1.5 dCi	60	06.01							
1.5 dCi RT	59	06.01	10.03						
1.6	66	03.98	05.01						
1.6 16V	79	04.02							
1.9 D	48	02.98	05.01						
	1.2	43	02.98	10.03		BAE5002		203 x 38 HEB LUC	
	1.2 16V	55	04.02						
	1.4	55	08.00						
	1.4 16V	72	08.00		- ABS				
	1.5 dCi	47	06.05						
	1.5 dCi	48	04.02						
	1.5 dCi	50	02.03						
	1.5 dCi	60	06.01						
	1.5 dCi RT	59	06.01	10.03					
	1.6	66	03.98	05.01					
1.6 16V	79	04.02							
1.9 D	48	02.98	05.01						
<b>RENAULT TRAFIC I Propulsion (PXX) (89-97)</b>									
	1.7	50	05.89	08.94		BA2086		20926 18,5 /WK BDX	
	2.0	59	05.89	10.97					
	2.1 D	43	05.89	06.94					
	2.1 D	47	06.94	10.97					
	1.7	50	05.89	08.94		BAR24103		252 24,0 22,0 V	
	2.0	59	05.89	10.97					
	2.1 D	43	05.89	06.94					
	2.1 D	47	06.94	10.97					
<b>RENAULT TRAFIC I Kasten (TXX) (89-01)</b>									
	1.9 D	44	06.97	03.01		BA2086		20926 18,5 /WK BDX	
	2.1 D	47	09.94	10.97					
	2.2	70	05.89	06.94					
	2.2	74	06.94	10.97					
	2.5 D	55	05.89	03.01					
	1.4	35	05.89	06.91		BAR24103		252 24,0 22,0 V	
	1.7	50	05.89	08.94					
	1.9 D	44	06.97	03.01					
	2.0	59	05.89	08.90					
	2.1 D	43	05.89	06.94					
	2.1 D	47	06.94	10.97					
	2.2	70	05.89	06.94					
	2.2	74	06.94	10.97					
2.5 D	55	05.89	03.01						
<b>RENAULT TRAFIC I Bus (TXW) (89-01)</b>									
	1.7	50	05.89	08.94		BA2086		20926 18,5 /WK BDX	
	1.9 D	44	06.97	03.01					
	2.0	59	05.89	08.90					
	2.1 D	43	05.89	06.94					
	2.1 D	47	06.94	10.97					
	2.2	70	05.89	06.94					
	2.2	74	06.94	10.97					
↓	↓								

								
<b>RENAULT TRAFIC I Bus (TXW) (89-01)</b>								
	2.5 D 2.5 D 4x4	55 55	05.89 08.89	03.01 03.01	BA2086			20926 18,5 /WK BDX
	1.7 1.9 D 2.0 2.1 D 2.1 D 2.2 2.2 2.5 D 2.5 D 4x4	50 44 59 43 47 70 74 55 55	05.89 06.97 05.89 05.89 06.94 05.89 06.94 05.89 08.89	08.94 03.01 08.90 06.94 10.97 06.94 10.97 03.01 03.01	BAR24103			252 24,0 22,0 V
<b>RENAULT TRAFIC II (JL/FL/EL) (01-)</b>								
	1.9 dCi 1.9 dCi 100 1.9 dCi 80 2.0 16V 2.0 16V 2.0 dCi 115 2.0 dCi 90 2.5 dCi 2.5 dCi 115 2.5 dCi 135 2.5 dCi 145 2.5 DTi	59 74 60 86 88 84 66 84 84 99 107 99	04.01 03.01 03.01 08.06 03.01 10.06 10.06 08.07 02.08 05.03 10.06 03.03	07.03	BA2254			23099 18,4 /S LUC
	1.9 dCi 1.9 dCi 100 1.9 dCi 80 2.0 16V 2.0 16V 2.0 dCi 115 2.0 dCi 90 2.5 dCi 2.5 dCi 115 2.5 dCi 135 2.5 dCi 145 2.5 DTi	59 74 60 86 88 84 66 84 84 99 107 99	04.01 03.01 03.01 08.06 03.01 10.06 10.06 08.07 02.08 05.03 10.06 03.03	07.03	BAR28132			306 28,0 24,0 V L
	1.9 dCi 1.9 dCi 100 1.9 dCi 80 2.0 16V 2.0 16V 2.0 dCi 115 2.0 dCi 90 2.5 dCi 2.5 dCi 115 2.5 dCi 135 2.5 dCi 145 2.5 DTi	59 74 60 86 88 84 66 84 84 99 107 99	04.01 03.01 03.01 08.06 03.01 10.06 10.06 08.07 02.08 05.03 10.06 03.03	07.03	BA2247			23980 16,0 /WE/S LUC
<b>RENAULT TWINGO I Limousine (C06_) (93-07)</b>								
	1.2 (C063,C064) 1.2 (C066,C068) 1.2 (C067)	40 43 40	03.93 05.96 05.96	10.96 09.98 + Schaltgetriebe 1) 09.98 + Schaltgetriebe 1)	BA2075 BA2077			20634 15,0 21097 15,0 +/WK BDX
	1.2 (C060) 1.2 (C066,C068) 1.2 (C067) 1.2 (C066,C068) 1.2 (C067) 1.2 (C06C,C06D,C06K)	44 43 40 43 40 55	08.04 10.98 10.98 10.98 01.01	07.07 + Automatikgetriebe 2) + Automatikgetriebe 2) + Automatikgetriebe 2) 07.07	BA2023			21463 18,0 /WK/S LUC
	1.2 (C063,C064) 1.2 (C066,C068) 1.2 (C067) 1.2 (C066,C068) 1.2 (C067) 1.2 (C066,C068) 1.2 (C060) 1.2 (C066,C068) 1.2 (C06C,C06D,C06K)	40 43 40 43 40 43 44 43 55	03.93 05.96 05.96 10.98 10.98 11.03 08.04 09.00 01.01	10.96 + Schaltgetriebe 1) + Schaltgetriebe 1) + Automatikgetriebe 2) + Automatikgetriebe 2) 07.07 07.07 10.03 07.07	BAR08104 BAR12116 BAR12171 BAR21106			238 8,2 7,0 238 12,0 10,5 259 12,0 10,6 259 20,6 17,7 V
	1.2 (C060) 1.2 (C063,C064) 1.2 (C066,C068) 1.2 (C067) 1.2 (C06C,C06D,C06K)	44 40 43 40 55	08.04 03.93 05.96 05.96 01.01	07.07 10.96 07.07 07.07 07.07	BAH0024	2		L=240
	1.2 (C063,C064) 1.2 (C066,C068) 1.2 (C067) 1.2 (C060) 1.2 (C066,C068) 1.2 (C067) 1.2 (C06C,C06D,C06K)	40 43 40 44 43 40 55	03.93 05.96 05.96 08.04 07.98 07.98 01.01	10.96 - ABS 07.07 - ABS 07.07 - ABS 07.07 + ABS + ABS 07.07	BAW2005 BAW2006 BAW1704			RzR 20,64 RzR 20,64 Rz 17,78 LUC
	1.2 (C063,C064) 1.2 (C066,C068) 1.2 (C067) 1.2 (C066,C068) 1.2 (C067)	40 43 40 43 40	03.93 05.96 05.96 05.96 05.96	10.96 - ABS - ABS + ABS + ABS	BAE5008 BAE5008			180 x 42 180 x 42 BDX

1) + manual transmission / + scatola cambio velocità / + transmission mécanique / + cambio de velocidad  
2) + autom.transmission / + scatola cambio automatico / + transmission automatique / + cambio automático





















								
<b>RENAULT TWINGO I Limousine (C06_) (93-07)</b>								
	1.2 (C060)	44	08.04	07.07	BAE5002			203 x 38 HEB LUC
	1.2 (C066,C068)	43	07.98	07.07 + ABS				
	1.2 (C067)	40	07.98	07.07 + ABS				
	1.2 (C06C,C06D,C06K)	55	01.01	07.07				
<b>RENAULT TWINGO I Kasten (S06_) (93-07)</b>								
	1.2 (S063,S064)	40	03.93	04.96	BA2075			20634 15,0 BDX
	1.2 (S066,S068)	43	05.96	09.98 + Schaltgetriebe <sup>1)</sup>				
	1.2 (S066,S068)	43	10.98	07.07 + Automatikgetriebe <sup>2)</sup>	BA2023			21463 18,0 /WK/S LUC
	1.2 (S066,S068)	43	10.98	07.07 + Schaltgetriebe <sup>1)</sup>				
	1.2 (S063,S064)	40	03.93	04.96	BAR08104			238 8,2 7,0
	1.2 (S066,S068)	43	05.96	09.98 + Schaltgetriebe <sup>1)</sup>				
	1.2 (S066,S068)	43	10.98	08.00 + Automatikgetriebe <sup>2)</sup>	BAR12116			238 12,0 10,5
	1.2 (S066,S068)	43	10.98	08.00 + Schaltgetriebe <sup>1)</sup>				
	1.2 (S066,S068)	43	09.00	10.03 + Automatikgetriebe <sup>2)</sup>	BAR21106			259 20,6 17,7 V
	1.2 (S066,S068)	43	09.00	10.03 + Schaltgetriebe <sup>1)</sup>				
	1.2 (S066,S068)	43	11.03	07.07	BAR12171			259 12,0 10,6
	1.2 (S063,S064)	40	03.93	04.96	BAH0024	2		L=240
	1.2 (S066,S068)	43	05.96	07.07				
	1.2 (S063,S064)	40	03.93	04.96 - ABS	BAW2005			RzR 20,64 BDX
	1.2 (S066,S068)	43	05.96	07.07 - ABS	BAW2006			RzR 20,64 BDX
	1.2 (S066,S068)	43	07.98	07.07 + ABS	BAW1704			Rz 17,78 LUC
	1.2 (S063,S064)	40	03.93	04.96 - ABS	BAE5008			180 x 42 BDX
	1.2 (S066,S068)	43	05.96	07.07 - ABS				
	1.2 (S063,S064)	40	03.93	04.96 + ABS	BAE5008			180 x 42 BDX
	1.2 (S066,S068)	43	05.96	06.98 + ABS				
	1.2 (S066,S068)	43	07.98	07.07 + ABS	BAE5002			203 x 38 HEB LUC
<b>RENAULT TWINGO II (CNO_) (07-)</b>								
	1.2	43	03.07		BA2023			21463 18,0 /WK/S LUC
	1.2 16V	55	03.07					
	1.2 16V	56	03.07					
	1.2 TCe 100	75	02.11					
	1.2 Turbo	74	03.07					
	1.5 dCi	47	03.07					
	1.5 dCi	62	04.08					
	1.5 dCi 75	55	10.10					
	1.5 dCi 90	63	10.10					
	1.2	43	03.07		BAR12171		- belüftete Scheiben <sup>3)</sup>	259 12,0 10,6
	1.5 dCi	47	03.07					
	1.2	43	03.07		BAR21106		+ belüftete Scheiben <sup>4)</sup>	259 20,6 17,7 V
	1.2 16V	55	03.07					
	1.2 16V	56	03.07					
	1.2 TCe 100	75	02.11					
	1.2 Turbo	74	03.07					
	1.5 dCi	47	03.07					
	1.5 dCi	62	04.08					
	1.5 dCi 75	55	10.10					
	1.5 dCi 90	63	10.10					
	1.6 RS	98	05.08		BAR24158			280 24,0 21,8 V L
<b>RENAULT VEL SATIS (BJO_) (02-)</b>								
	2.0	108	04.05		BA2238			23482 16,4 + ATE
	2.0 16V Turbo	120	06.02					
	2.0 16V Turbo	125	04.04					
	2.0 dCi	110	08.05					
	2.0 dCi	127	01.06					
	2.2 dCi	85	04.04					
	2.2 dCi	110	06.02					
	3.0 dCi	130	06.02					
	3.0 dCi	133	06.06					
	3.5	170	10.04					
	3.5 V6	177	06.02					
<b>RENAULT WIND (E4M_) (10-)</b>								
	1.2 16V Turbo	74	07.10		BAR24158			280 24,0 21,8 V L
	1.2 TCe 100	75	02.11					
	1.6 16V	98	07.10					
<b>ROVER 25-Serie (RF) (99-)</b>								
	1.1 16V	55	01.04		BA2010			21515 17,5 +/-WK LUC
	1.4 16V	62	10.99					
	1.4 16V	76	10.99					
	1.6 16V	80	10.99					
	1.8 16V	85	10.99					
	1.8 16V	107	02.00					
	2.0 iDT	74	10.99					
	1.1 16V	55	01.04		BAR21105			262 21,0 19,0 V
	1.4 16V	62	10.99					
	1.4 16V	76	10.99					
	1.6 16V	80	10.99					
	1.8 16V	85	10.99					
	1.8 16V	107	02.00					
	2.0 iDT	74	10.99					

1) + manual transmission / + scatola cambio velocità / + transmission mécanique / + cambio de velocidad  
2) + autom.transmission / + scatola cambio automatico / + transmission automatique / + cambio automático  
3) - ventilated discs / - dischi ventilati / - disques ventilés / - disco ventilado  
4) + ventilated discs / + dischi ventilati / + disques ventilés / + disco ventilado

								
<b>ROVER 25-Serie (RF) (99-)</b>								
	1.1 16V 1.4 16V 1.4 16V 1.6 16V 1.8 16V 1.8 16V 2.0 iDT	55 62 76 80 85 107 74	01.04 10.99 10.99 10.99 10.99 02.00 10.99		BAW1911			Rz 19,05
<b>ROVER 45-Serie (RT) (00-)</b>								
	1.4 1.6 1.8 2.0 iDT 2.0 V6	76 80 86 74 110	02.00 02.00 02.00 02.00 02.00		BA2010			21515 17,5 +/WK LUC
	1.4 1.6 1.8 2.0 iDT 2.0 V6	76 80 86 74 110	02.00 02.00 02.00 02.00 02.00		BAR21105			262 21,0 19,0 V
	1.4 1.6 1.8 2.0 iDT 2.0 V6	76 74465 80 74465 86 74465 74 74465 110 74465			BAW1911			Rz 19,05
<b>ROVER 75-Serie (RJ) (99-04)</b>								
	1.8 1.8 Turbo 2.0 CDT 2.0 CDTi 2.0 V6 2.5 V6 2.5 V6	88 110 85 96 110 129 130	02.99 05.04 05.03 05.04 02.99 05.04 02.03 05.04 02.99 05.04 02.99 10.01 08.01 05.04		BAR22206			284 22,0 19,0 V
	1.8 1.8 Turbo 2.0 CDT 2.0 CDTi 2.0 V6 2.5 V6 2.5 V6	88 110 85 96 110 129 130	02.99 05.04 05.03 05.04 02.99 05.04 02.03 05.04 02.99 05.04 02.99 10.01 08.01 05.04		BA2053			20180 17,3 +/WE ATE
<b>ROVER 75 Serie (RX) (04-)</b>								
	1.8 1.8 Turbo 2.0 CDTi 2.5 V6 4.6 V8	88 110 96 130	04.04 04.04 04.04 04.04		BA2190	+ Scheibe 325X25 <sup>1)</sup>		23183 20,3 +/WE ATE
	1.8 1.8 Turbo 2.0 CDTi 2.5 V6 4.6 V8	88 110 96 130	04.04 04.04 04.04 04.04		BAR22206	+ Scheibe 284X22 <sup>2)</sup>		284 22,0 19,0 V
	1.8 1.8 Turbo 2.0 CDTi 2.5 V6	88 110 96 130	04.04 04.04 04.04 04.04		BA2053			20180 17,3 +/WE ATE
<b>ROVER 100-Serie (XP) (90-98)</b>								
	114 114 16V		05.90 12.98 05.90 12.98		BA2011			21518 17,0 LUC
<b>ROVER 200-Serie (XW) (90-95)</b>								
	214 216 218 D 220 Turbo		10.89 10.95 10.89 10.95 09.91 10.95 01.93 10.95		BA2012 BA2010	- ABS + ABS		21520 17,5 +/WK LUC 21515 17,5 +/WK LUC
<b>ROVER 200 II-Serie (RF) (96-00)</b>								
	211 214 i 214 Si 216 Si 218 i 16V Vitesse 220 D 220 SDi	44	01.98 03.00 01.96 03.00 11.95 03.00 11.95 03.00 01.96 03.00 01.96 03.00 01.96 03.00		BA2010			21515 17,5 +/WK LUC
	211 214 i 214 Si 216 Si 218 i 16V Vitesse 220 SDi	44	01.98 03.00 01.96 03.00 11.95 03.00 11.95 03.00 01.96 03.00 01.96 03.00 + ABS		BAR21105			262 21,0 19,0 V
	211 214 i 214 Si 216 Si	44	01.98 03.00 01.96 03.00 11.95 03.00 01.96 03.00	- ABS - ABS - ABS - ABS	BAW1911			Rz 19,05

<sup>1)</sup> + disc 325X25 / + disco 325X25 / + disque 325X25 / + disco 325X25

<sup>2)</sup> + disc 284X22 / + disco 284X22 / + disque 284X22 / + disco 284X22













									
<b>ROVER 200 II-Serie (RF) (96-00)</b>									
	218 i 16V Vitesse 220 D 220 SDi		01.97 01.96 01.96	03.00 03.00 03.00	- ABS - ABS - ABS	BAW1911		Rz 19,05	
<b>ROVER 400-Serie (XW) (90-95)</b>									
	414 416 16V 418 418 TD		04.90 04.90 09.91 01.91	04.95 04.95 04.95 04.95		BA2012 BA2010	- ABS + ABS	21520 17,5 +/-WK 21515 17,5 +/-WK	LUC LUC
<b>ROVER 400-Serie (RT) (95-00)</b>									
	414 Si 416 Si 420 D 420 Di 420 Si	76  63 77 100	05.95 06.95 11.95 05.95 12.95	03.00 03.00 03.00 03.00 03.00		BA2010		21515 17,5 +/-WK	LUC
	414 Si 416 Si 420 D 420 Di 420 Si	76  63 77 100	06.95 06.95 11.95 05.95 06.95	03.00 03.00 03.00 03.00 03.00	+ ABS	BAR21105		262 21,0 19,0 V	
	414 Si 416 Si 420 D 420 Di 420 Si	76  63 77 100	05.95 06.95 11.95 05.95 12.95	03.00 03.00 03.00 03.00 03.00	- ABS - ABS - ABS - ABS	BAW1911		Rz 19,05	
<b>ROVER 600-Serie (RH) (93-99)</b>									
	618 i 618 Si 620 i 620 SDi 620 Si 620 Ti Vitesse 623 Si		03.96 03.96 08.93 12.94 08.93 07.94 08.93	02.99 02.99 02.99 02.99 02.99 02.99 02.99		BA2280		21719 15,0 +/-WK	AKE
<b>SAAB 9-3 Limousine (YS3D) (98-02)</b>									
	2.0 i 2.0 SE Turbo 2.0 Turbo 2.0 Turbo 2.0 Turbo 2.2 TiD 2.2 TiD 2.3 i 2.3 Vigen	96 147 113 136 151 85 92 110 165	02.98 02.98 10.98 02.98 10.99 02.98 11.00 02.98 10.98	09.02 09.02 09.02 09.02 09.02 11.00 09.02 09.02 09.02		BAV1014	2	Warnkontakt L=740mm	
	2.0 i 2.0 SE Turbo 2.0 Turbo 2.0 Turbo 2.0 Turbo 2.2 TiD 2.2 TiD 2.3 i	96 147 113 136 151 85 92 110	02.98 02.98 10.98 02.98 10.99 02.98 11.00 02.98	09.02 09.02 09.02 09.02 09.02 11.00 09.02 09.02		BAR25119		288 25,0 22,0 V L	
	2.0 i 2.0 SE Turbo 2.0 Turbo 2.0 Turbo 2.0 Turbo 2.2 TiD 2.2 TiD 2.3 i 2.3 Vigen	96 147 113 136 151 85 92 110 165	02.98 02.98 10.98 02.98 10.99 02.98 11.00 02.98 10.98	09.02 09.02 09.02 09.02 09.02 11.00 09.02 09.02 09.02		BA2095		21050 15,7	ATE
	2.0 i 2.0 SE Turbo 2.0 Turbo 2.0 Turbo 2.0 Turbo 2.2 TiD 2.2 TiD 2.3 i	96 147 113 136 151 85 92 110	02.98 02.98 10.98 02.98 10.99 02.98 11.00 02.98	09.02 09.02 09.02 09.02 09.02 11.00 09.02 09.02		BAR10226		286 10,0 8,0	
<b>SAAB 9-3 Limousine (YS3F) (03-)</b>									
	1.8 i 1.8 i 1.8 t 1.8 t 1.9 TiD 1.9 TiD 1.9 TiD 1.9 TiD 2.0 t 2.0 t 2.0 Turbo Performance 2.2 TiD 2.2 TiD	90 90 110 110 88 88 110 110 110 110 92 92	03.04 03.04 09.02 09.02 07.04 07.04 07.04 07.04 09.02 09.02 04.04 09.02 09.02	12.05 12.05 12.05 12.05 12.05 12.05 12.05 12.05 12.05 12.05 12.05 12.05 12.05	+ 15" Rad <sup>1)</sup> + 16" Rad/ - Vector <sup>2)</sup> + 15" Rad <sup>1)</sup> + 16" Rad/ - Vector <sup>2)</sup> + 15" Rad <sup>1)</sup> + 16" Rad/ - Vector <sup>2)</sup> + 15" Rad <sup>1)</sup> + 16" Rad/ - Vector <sup>2)</sup> + 15" Rad <sup>1)</sup> + 16" Rad/ - Vector <sup>2)</sup> + 15" Rad <sup>1)</sup> + 15" Rad <sup>1)</sup> + 16" Rad/ - Vector <sup>2)</sup>	BA2236	für Bremssattel mit Kunststoffkolben	23402 20,4 +/-WE	ATE

<sup>1)</sup> + 15" wheel / + ruota 15" / + roue 15" / + rueda 15"

<sup>2)</sup> + 16" wheel/ - Vector / + ruota 16"/ - Vector / + roue 16"/ - Vector / + rueda 16"/ - Vector

<sup>3)</sup> + for br.caliper +plastic piston / per pinza fr. +pistone plastica / pour étrier fr. +piston plastique / para pinza fr. + pistón plastic

















									
<b>SAAB 9-3 Limousine (YS3F) (03-)</b>									
	1.8 i 1.8 i Vector 1.8 t BioPower 1.9 TiD 1.9 TiD 1.9 TiD Vector 1.9 TiD Vector 1.9 TTiD 1.9 TTiD 2.0 t 2.0 T Aero 2.0 t BioPower 2.0 t BioPower 2.0 t BioPower XWD 2.0 t Vector 2.0 t XWD 2.0 Turbo Performance 2.2 TiD 2.2 TiD Vector 2.8 T Aero 2.8 T Aero 2.8 T Aero 2.8 T Aero V6 XWD 2.8 Turbo V6	90 90 110 88 110 88 110 88 110 154 145 129 92 92 184 188 206 206		01.06 09.02 01.07 01.06 01.06 07.04 07.04 07.07 07.07 01.06 09.02 01.07 06.07 09.02 09.02 01.07 04.04 01.06 09.02 03.05 07.07 07.07 04.08 04.08	12.08 12.08 12.08 - Vector 12.08 - Vector 12.08 - Vector 12.08 - Vector 12.08 12.08 12.08 12.08 12.08 12.08 12.08 12.08 - Vector 12.08 12.08 12.08 12.08 12.08 12.08	BA2236	+ 16" Rad/ + USA/+ Kunststoffkolben	23402 20,4 +/WE	ATE
	1.8 i 1.8 t 1.8 t BioPower 1.9 TiD 1.9 TiD 1.9 TTiD 2.0 t Arc/Linear 2.0 t BioPower 2.0 t BioPower 2.0 Turbo Performance 2.2 TiD	90 110 110 88 110 129 145 92		03.04 09.02 01.07 07.04 07.04 07.07 09.02 01.07 06.07 04.04 09.02		BAR25141	+ 15" Rad <sup>1)</sup>	285 24,9 22,0 V L	
	1.8 i 1.8 t 1.8 t BioPower 1.9 TiD 1.9 TiD 1.9 TTiD 2.0 t 2.0 T Aero 2.0 t BioPower 2.0 t BioPower 2.0 t BioPower XWD 2.0 t XWD 2.0 Turbo Performance 2.2 TiD 2.8 T Aero 2.8 T Aero 2.8 T Aero 2.8 T Aero V6 XWD 2.8 Turbo V6	90 110 110 88 110 154 145 92 184 188 206 206	76001222 76001222 76001222 76001222 76001222 76001222 76001222 76001222 76001222 76001222 76001222 76001222 76001222 76001222 76001222 76001222 76001222 76001222	03.04 09.02 01.07 07.04 07.04 07.07 09.02 09.02 01.07 06.07 09.02 01.07 04.04 09.02 03.05 07.07 07.07 04.08 04.08		BA2235		23482 16,4 +	ATE
	1.8 i 1.8 t 1.8 t BioPower 1.9 TiD 1.9 TiD 1.9 TTiD 2.0 t 2.0 T Aero 2.0 t BioPower 2.0 t BioPower 2.0 t BioPower XWD 2.0 t XWD 2.0 Turbo Performance 2.2 TiD 2.8 T Aero 2.8 T Aero 2.8 T Aero 2.8 T Aero V6 XWD 2.8 Turbo V6	90 110 110 88 110 154 145 92 184 188 206 206	76001223 76001223 76001223 76001223 76001223 76001223 76001223 76001223 76001223 76001223 76001223 76001223 76001223 76001223 76001223 76001223 76001223 76001223 76001223			BA2258		23482 16,4 +	ATE
	1.8 i 1.8 t 1.8 t BioPower 1.9 TiD 1.9 TiD 1.9 TTiD 2.0 t 2.0 T Aero 2.0 t BioPower 2.0 t BioPower 2.0 Turbo Performance 2.2 TiD 2.8 T Aero 2.8 T Aero	90 110 110 88 110 154 145 92 184 188		03.04 09.02 01.07 07.04 07.04 07.07 09.02 09.02 01.07 06.07 04.04 09.02 03.05 07.07		BAR12157	+ 15" Rad <sup>1)</sup>	278 12,0 10,0	

1) + 15" wheel / + ruota 15" / + roue 15" / + rueda 15"

















2) + 16" wheel / + ruota 16" / + roue 16" / + rueda 16"

3) +plastic piston / +pistone plastica / +piston plastique / + pistón plastic

								
<b>SAAB 9-3 Limousine (YS3F) (03-)</b>								
	2.8 T Aero 2.8 Turbo V6	206	07.07 04.08		BAR12157		+ 15" Rad <sup>1)</sup>	278 12,0 10,0
<b>SAAB 9-3 SportCombi (05-)</b>								
	1.8 i 1.8 t 1.8 t BioPower 1.8 t BioPower 1.9 TiD 1.9 TiD 1.9 TTiD 2.0 2.0 t 2.0 t BioPower 2.0 t BioPower 2.0 t BioPower 2.0 t BioPower XWD 2.0 t XWD	90 110 110 129 88 110 143 145 147	03.05 03.05 01.07 07.07 03.05 03.05 07.07 04.06 03.05 01.07 06.07 07.07 01.07 01.07	09.07	BA2236		+ 15"/16" Rad/+ Kunststoffkolben	23402 20,4 +/-WE ATE
	1.8 i 1.8 t 1.8 t BioPower 1.8 t BioPower 1.9 TiD 1.9 TiD 1.9 TTiD 2.0 2.0 t 2.0 t BioPower 2.0 t BioPower 2.0 t BioPower XWD 2.0 t XWD	90 110 110 129 88 110 143 145 147	03.05 03.05 01.07 07.07 03.05 03.05 07.07 04.06 03.05 01.07 06.07 07.07 01.07 01.07	09.07	BAR25141		+ 15" Rad <sup>1)</sup>	285 24,9 22,0 V L
	1.8 i 1.8 t 1.8 t BioPower 1.8 t BioPower 1.9 TiD 1.9 TiD 1.9 TTiD 2.0 2.0 t 2.0 T 2.0 t BioPower 2.0 t BioPower 2.0 t BioPower 2.0 t BioPower XWD 2.0 t XWD 2.0 T XWD 2.0 T XWD 2.8 T 2.8 T 2.8 T Aero 2.8 T Aero V6 XWD 2.8 Turbo V6 2.8 Turbo V6	90 110 110 129 88 110 143 145 147 154 177 184 188 206 206 169 203	76001222 03.05 76001222 03.05 76001222 01.07 76001222 07.07 76001222 03.05 76001222 03.05 76001222 07.07 76001222 04.06 76001222 03.05 76001222 03.05 76001222 01.07 76001222 06.07 76001222 07.07 76001222 01.07 76001222 01.07 76001222 07.08 76001222 03.09 76001222 03.05 76001222 07.07 76001222 07.07 76001222 04.08 76001222 03.05 76001222 05.08		BA2235		23482 16,4 + ATE	
	1.8 i 1.8 t 1.8 t BioPower 1.8 t BioPower 1.9 TiD 1.9 TiD 1.9 TTiD 2.0 2.0 t 2.0 T 2.0 t BioPower 2.0 t BioPower 2.0 t BioPower 2.0 t BioPower XWD 2.0 t XWD 2.0 T XWD 2.0 T XWD 2.8 T 2.8 T 2.8 T Aero 2.8 T Aero V6 XWD 2.8 Turbo V6 2.8 Turbo V6	90 110 110 129 88 110 143 145 147 154 177 184 188 206 206 169 203	76001223 03.05 76001223 03.05 76001223 01.07 76001223 07.07 76001223 03.05 76001223 03.05 76001223 07.07 76001223 04.06 76001223 03.05 76001223 03.05 76001223 01.07 76001223 06.07 76001223 07.07 76001223 01.07 76001223 01.07 76001223 07.08 76001223 03.09 76001223 03.05 76001223 07.07 76001223 07.07 76001223 04.08 76001223 03.05 76001223 05.08		BA2258		23482 16,4 + ATE	
	1.8 i 1.8 t 1.9 TiD 1.9 TiD 2.0 t	90 110 88 110	03.05 08.05 03.05 08.05 03.05 08.05 03.05 08.05 03.05 08.05		BAR12157			278 12,0 10,0
	1.8 i 1.8 t 1.8 t BioPower 1.8 t BioPower	90 110 110 129	09.05 09.05 01.07 07.07		BAR12157		+ 15" Rad <sup>1)</sup>	278 12,0 10,0















<sup>1)</sup> + 15" wheel / + ruota 15" / + roue 15" / + rueda 15"

<sup>2)</sup> +plastic piston / +pistone plastica / +piston plastique / + pistón plastic

								
<b>SAAB 9-3 SportCombi (05-)</b>								
	1.9 TiD 88		09.05		BAR12157		+ 15" Rad <sup>1)</sup>	278 12,0 10,0
	1.9 TiD 110		09.05					
	1.9 TTiD		07.07					
	2.0 143		04.06	09.07				
	2.0 t		09.05					
	2.0 T		09.05					
	2.0 t BioPower		01.07					
	2.0 t BioPower 145		06.07					
	2.0 t BioPower 147		07.07					
	2.0 t BioPower XWD		01.07					
	2.0 t XWD		01.07					
	2.0 T XWD 154		07.08					
	2.0 T XWD 177		03.09					
	2.8 T 184		09.05					
	2.8 T 188		07.07					
	2.8 T Aero 206		07.07					
	2.8 T Aero V6 XWD 206		04.08					
	2.8 Turbo V6 169		03.05					
	2.8 Turbo V6 203		05.08					
<b>SAAB 9-3 Coupe (YS3D) (98-02)</b>								
	2.0 96		02.98	09.02	BAV1014	2		Warnkontakt L=740mm
	2.0 110		01.01	09.02				
	2.0 Turbo 113		10.98	09.02				
	2.0 Turbo 136		02.98	09.02				
	2.0 Turbo 151		10.99	09.02				
	2.0 Turbo Sport 147		02.98	09.02				
	2.2 TiD 85		02.98	11.00				
	2.2 TiD 92		11.00	09.02				
	2.3 110		02.98	09.02				
	2.3 Viggen 165		10.98	09.02				
	2.0 96		02.98	09.02	BAR25119			288 25,0 22,0 V L
	2.0 110		01.01	09.02				
	2.0 Turbo 113		10.98	09.02				
	2.0 Turbo 136		02.98	09.02				
	2.0 Turbo 151		10.99	09.02				
	2.0 Turbo Sport 147		02.98	09.02				
	2.2 TiD 85		02.98	11.00				
	2.2 TiD 92		11.00	09.02				
	2.3 110		02.98	09.02				
	2.3 Viggen 165		10.98	09.02				
	2.0 96		02.98	09.02	BA2095			21050 15,7 ATE
	2.0 110		01.01	09.02				
	2.0 Turbo 113		10.98	09.02				
	2.0 Turbo 136		02.98	09.02				
	2.0 Turbo 151		10.99	09.02				
	2.0 Turbo Sport 147		02.98	09.02				
	2.2 TiD 85		02.98	11.00				
	2.2 TiD 92		11.00	09.02				
	2.3 110		02.98	09.02				
	2.3 Viggen 165		10.98	09.02				
	2.0 96		02.98	09.02	BAR10226			286 10,0 8,0
	2.0 110		01.01	09.02				
	2.0 Turbo 113		10.98	09.02				
	2.0 Turbo 136		02.98	09.02				
	2.0 Turbo 151		10.99	09.02				
	2.0 Turbo Sport 147		02.98	09.02				
	2.2 TiD 85		02.98	11.00				
	2.2 TiD 92		11.00	09.02				
	2.3 110		02.98	09.02				
	2.3 Viggen 165		10.98	09.02				
<b>SAAB 9-3 Cabriolet (YS3D) (98-03)</b>								
	2.0 i 96		02.98	08.02	BAV1014	2		Warnkontakt L=740mm
	2.0 SE Turbo 147		02.98	08.02				
	2.0 T 113		10.98	08.02				
	2.0 T 136		02.98	08.02				
	2.0 T 151		10.99	08.02				
	2.0 Turbo 110		01.01	08.02				
	2.3 i 110		02.98	08.02				
	2.3 i 165		10.99	08.02				
	2.0 i 96		09.02	07.03	BA2236		für Bremssattel mit Kunststoffkolben	23402 20,4 +/WE ATE
	2.0 SE Turbo 147		09.02	07.03				
	2.0 T 113		09.02	07.03				
	2.0 T 136		09.02	07.03				
	2.0 T 151		09.02	07.03				
	2.0 Turbo 110		09.02	07.03				
	2.3 i 110		09.02	07.03				
	2.3 i 165		09.02	07.03				
	2.0 i 96		02.98	07.03	BAR25119			288 25,0 22,0 V L
	2.0 SE Turbo 147		02.98	07.03				
	2.0 T 113		10.98	07.03				
	2.0 T 136		02.98	07.03				
	2.0 T 151		10.99	07.03				
	2.0 Turbo 110		01.01	07.03				
	2.3 i 110		02.98	07.03				

<sup>1)</sup> + 15" wheel / + ruota 15" / + roue 15" / + rueda 15"

















<sup>2)</sup> + for br.caliper +plastic piston / per pinza fr. +pistone plastica / pour étrier fr. +piston plastique / para pinza fr. + pistón plastic

										
<b>SAAB 9-3 Cabriolet (YS3D) (98-03)</b>										
	2.0 i	96		02.98	08.02		BA2095		21050 15,7	ATE
	2.0 SE Turbo	147		02.98	08.02					
	2.0 T	113		10.98	08.02					
	2.0 T	136		02.98	08.02					
	2.0 T	151		10.99	08.02					
	2.0 Turbo	110		01.01	08.02					
	2.3 i	110		02.98	08.02					
	2.3 i	165		10.99	08.02					
	2.0 i	96		09.02	07.03		BA2235		23482 16,4 +	ATE
	2.0 SE Turbo	147		09.02	07.03					
	2.0 T	113		09.02	07.03					
	2.0 T	136		09.02	07.03					
	2.0 T	151		09.02	07.03					
	2.0 Turbo	110		09.02	07.03					
2.3 i	110		09.02	07.03						
2.3 i	165		09.02	07.03						
	2.0 i	96		02.98	07.03		BAR10226		286 10,0 8,0	
	2.0 SE Turbo	147		02.98	07.03					
	2.0 T	113		10.98	07.03					
	2.0 T	136		02.98	07.03					
	2.0 T	151		10.99	07.03					
	2.0 Turbo	110		01.01	07.03					
	2.3 i	110		02.98	07.03					
	2.3 i	165		02.98	07.03					
<b>SAAB 9-3 Cabriolet (YS3F) (03-)</b>										
	1.8 t	110		08.03			BA2236	+ 15"/16" Rad/+ Kunststoffkolben	23402 20,4 +/-WE	ATE
	1.8 t BioPower	110		01.07						
	1.8 t BioPower	129		07.07						
	1.9 TiD	110		01.06						
	1.9 TTiD			07.07						
	2.0	143		04.06	09.07					
	2.0 t			08.03						
	2.0 T			08.03		- ☒				
	2.0 t BioPower			01.07						
	2.0 t BioPower			06.07						
	2.0 t BioPower	147		07.07						
	2.0 Turbo Performance	185		04.04						
	2.0 T			08.03		+ ☒ ☒	BA2236	+ 16" Rad/+ Kunststoffkolben	23402 20,4 +/-WE	ATE
	2.0 Turbo Performance	185		04.04		+ ☒ ☒				
	1.8 t	110		08.03			BAR25141	+ 15" Rad <sup>1)</sup>	285 24,9 22,0 V L	
	1.8 t BioPower	110		01.07						
	1.8 t BioPower	129		07.07						
	1.9 TiD	110		01.06						
	1.9 TTiD			07.07						
	2.0	143		04.06	09.07					
	2.0 t			08.03						
	2.0 T			08.03						
	2.0 t BioPower			01.07						
	2.0 t BioPower			06.07						
	2.0 t BioPower	147		07.07						
	2.0 t Linear	129		08.03						
	2.0 t Vector	129		08.03						
	2.0 Turbo Performance	185		04.04						
	1.8 t	110	76001222	08.03			BA2235		23482 16,4 +	ATE
	1.8 t BioPower	110	76001222	01.07						
	1.8 t BioPower	129	76001222	07.07						
	1.9 TiD	110	76001222	01.06						
	1.9 TTiD		76001222	07.07						
	2.0	143	76001222	04.06						
	2.0 t		76001222	08.03						
	2.0 T		76001222	08.03						
	2.0 t BioPower		76001222	01.07						
	2.0 t BioPower		76001222	06.07						
	2.0 t BioPower	147	76001222	07.07						
	2.0 Turbo Performance	185	76001222	04.04						
	2.8 T	184	76001222	02.06						
	2.8 T	221	76001222	10.08						
	2.8 T Aero	188	76001222	07.07						
	2.8 T V6 Aero		76001222	06.08						
	1.8 t	110	76001223				BA2258		23482 16,4 +	ATE
	1.8 t BioPower	110	76001223							
	1.8 t BioPower	129	76001223							
	1.9 TiD	110	76001223							
	1.9 TTiD		76001223							
	2.0	143	76001223		09.07					
2.0 t		76001223								
2.0 T		76001223								
2.0 t BioPower		76001223								
2.0 t BioPower		76001223								
2.0 t BioPower	147	76001223								
2.0 Turbo Performance	185	76001223								
2.8 T	184	76001223								
2.8 T	221	76001223								
2.8 T Aero	188	76001223								
2.8 T V6 Aero		76001223								

<sup>1)</sup> + 15" wheel / + ruota 15" / + roue 15" / + rueda 15"

<sup>2)</sup> +plastic piston / +pistone plastica / +piston plastique / + pistón plastic





<sup>3)</sup> + 16" wheel / + ruota 16" / + roue 16" / + rueda 16"

								
<b>SAAB 9-3 Cabriolet (YS3F) (03-)</b>								
	1.8 t	110	08.03	08.05	BAR12157			278 12,0 10,0
	2.0 t Linear	129	08.03	08.05				
	1.8 t	110	09.05		BAR12157		+ 15" Rad <sup>1)</sup>	278 12,0 10,0
	1.8 t BioPower	110	01.07					
	1.8 t BioPower	129	07.07					
	1.9 TiD	110	01.06					
	1.9 TTiD		07.07					
	2.0	143	04.06	09.07				
	2.0 t		09.05					
	2.0 T		09.05					
	2.0 t BioPower		01.07					
	2.0 t BioPower		06.07					
	2.0 t BioPower	147	07.07					
	2.0 t Linear	129	09.05					
	2.0 t Vector	129	09.05					
	2.0 Turbo Performance	185	04.04					
	2.8 T	184	02.06					
	2.8 T	221	10.08					
	2.8 T Aero	188	07.07					
	2.8 T V6 Aero		06.08					
<b>SAAB 9-3 X (09-)</b>								
	1.9 TTiD	96	01.10		BA2236		+ 15"/16" Rad/+ Kunststoffkolben	23402 20,4 +/WE ATE
	1.9 TTiD	132	03.09					
	2.0 T BioPower XWD	120	01.11					
	2.0 T BioPower XWD	154	03.09					
	2.0 T BioPower XWD	162	01.11					
	2.0 T XWD	154	03.09					
	1.9 TTiD	96	01.10		BAR25141		+ 15" Rad <sup>1)</sup>	285 24,9 22,0 V L
	1.9 TTiD	132	03.09					
	2.0 T BioPower XWD	120	01.11					
	2.0 T BioPower XWD	154	03.09					
	2.0 T BioPower XWD	162	01.11					
	2.0 T XWD	154	03.09					
	1.9 TTiD	96	01.10		BA2258			23482 16,4 + ATE
	1.9 TTiD	132	03.09					
	2.0 T BioPower XWD	120	01.11					
	2.0 T BioPower XWD	154	03.09					
	2.0 T BioPower XWD	162	01.11					
	2.0 T XWD	154	03.09					
	1.9 TTiD	96	01.10		BAR12157		+ 15" Rad <sup>1)</sup>	278 12,0 10,0
	1.9 TTiD	132	03.09					
	2.0 T BioPower XWD	120	01.11					
	2.0 T BioPower XWD	154	03.09					
	2.0 T BioPower XWD	162	01.11					
	2.0 T XWD	154	03.09					
<b>SAAB 9-5 Limousine (YS3E) (97-10)</b>								
	1.9 TiD	110	01.06	02.10	BA2207		+ 16" Rad <sup>2)</sup>	21829 20,3 +/WE ATE
	2.0		07.00	02.10	BAV1014	2		Warnkontakt L=740mm
	2.0 t	110	09.97	02.10				
	2.0 t BioPower	110	01.05	02.10				
	2.0 t BioPower	132	06.06	02.10				
	2.0 Turbo SE	141	10.98	07.00				
	2.2 TiD	88	03.02	02.10				
	2.3 t	125	09.97	02.10				
	2.3 T	134	04.08	02.10				
	2.3 t	136	01.01	02.10				
	2.3 T	162	07.03	02.10				
	2.3 T	188	04.08	02.10				
	2.3 T	191	11.05	02.10				
	2.3 T Aero	169	01.00	09.01				
	2.3 T Aero	184	09.01	02.10				
	2.3 T Aero	225	04.03	03.04				
	2.3 t BioPower	136	01.07	02.10				
	2.3 t BioPower	152	11.06	02.10				
	2.3 t BioPower	154	01.07	02.10				
	3.0 t	147	01.98	02.10				
	3.0 TiD	130	07.01	02.10				
	1.9 TiD	110	01.06	02.10	BAR25119		+ 15" Rad <sup>1)</sup>	288 25,0 22,0 V L
	2.0		07.00	02.10				
	2.0 t	110	09.97	02.10				
	2.0 t BioPower	110	01.05	02.10				
	2.0 t BioPower	132	06.06	02.10				
	2.0 Turbo SE	141	10.98	07.00				
	2.2 TiD	88	03.02	02.10				
	2.3 t	125	09.97	02.10				
	2.3 T	134	04.08	02.10				
	2.3 t	136	01.01	02.10				
	2.3 T	162	07.03	02.10				
	2.3 T	162 43510123		02.10				
	2.3 t BioPower	136	01.07	02.10				
	2.3 t BioPower	152	11.06	02.10				
	2.3 t BioPower	154	01.07	02.10				
	2.3 T	162	43510122	07.03	BAR25142		+ 16" Rad <sup>2)</sup>	308 25,0 22,0 V L
	2.3 T	188	04.08	02.10				
	2.3 T	191	11.05	02.10				

<sup>1)</sup> + 15" wheel / + ruota 15" / + roue 15" / + rueda 15"













<sup>2)</sup> + 16" wheel / + ruota 16" / + roue 16" / + rueda 16"

<sup>3)</sup> +plastic piston / +pistone plastica / +piston plastique / + pistón plastic



















SAAB 9-5 Limousine (YS3E) (97-10)										
	2.3 T Aero	169		10.99	09.01		BAR25142		+ 16" Rad <sup>1)</sup>	308 25,0 22,0 V L
	2.3 T Aero	184		09.01	02.10					
	2.3 T Aero	225		04.03	03.04					
	3.0 t	147		01.98	02.10					
	3.0 TiD	130		07.01	02.10					
	2.0 t	110	X3025751	09.97			BA2095			21050 15,7 ATE
	2.0 Turbo SE	141	X3025751	10.98						
	2.3 t	125	X3025751	09.97						
	3.0 t	147	X3025751	01.98						
	1.9 TiD	110		01.06	02.10		BA2053			20180 17,3 +/WE ATE
	2.0			07.00	02.10					
	2.0 t	110	X3025752		02.10					
	2.0 t BioPower	110		01.05	02.10					
	2.0 t BioPower	132		06.06	02.10					
	2.0 Turbo SE	141	X3025752		07.00					
	2.2 TiD	88		03.02	02.10					
	2.3 t	125	X3025752		02.10					
	2.3 T	134		04.08	02.10					
	2.3 t	136		01.01	02.10					
	2.3 T	162		07.03	02.10					
	2.3 T	188		04.08	02.10					
	2.3 T	191		11.05	02.10					
	2.3 T Aero	169		10.99	09.01					
	2.3 T Aero	184		09.01	02.10					
	2.3 T Aero	225		04.03	03.04					
	2.3 t BioPower	136		01.07	02.10					
	2.3 t BioPower	152		11.06	02.10					
	2.3 t BioPower	154		01.07	02.10					
	3.0 t	147	X3025752		02.10					
	3.0 TiD	130		07.01	02.10					
	2.0 t	110	X3025751	09.97			BAR10226			286 10,0 8,0
	2.0 Turbo SE	141	X3025751	10.98						
	2.3 t	125	X3025751	09.97						
	3.0 t	147	X3025751	01.98						
SAAB 9-5 Kombi (YS3E) (98-10)										
	1.9 TiD	110		01.06	02.10		BA2207		+ 16" Rad <sup>1)</sup>	21829 20,3 +/WE ATE
	1.9 TiD	129		01.07	02.10		BAV1014	2		Warnkontakt L=740mm
	2.0	136		07.00	07.01					
	2.0 t			10.98	02.10					
	2.0 t	110		10.98	02.10					
	2.0 t BioPower			06.06	02.10					
	2.0 t BioPower	110		01.06	02.10					
	2.2 TiD	88		03.02	02.10					
	2.3	224		06.03	08.05					
	2.3 t	125		10.98	02.10					
	2.3 t	136		01.02	02.10					
	2.3 T	162		07.03	02.10					
	2.3 T	188		04.08	02.10					
	2.3 T	191		01.06	02.10					
	2.3 T Aero	169		10.99	09.01					
	2.3 T Aero	184		09.01	02.10					
	2.3 T Aero	225		04.03	03.04					
	2.3 t BioPower	136		01.07	02.10					
	2.3 t BioPower	152		11.06	02.10					
	2.3 t BioPower	154		01.07	02.10					
	3.0 t	147		10.98	02.10					
	3.0 TiD	130		07.01	02.10					
	1.9 TiD	110		01.06	02.10		BAR25119		+ 15" Rad <sup>2)</sup>	288 25,0 22,0 V L
	1.9 TiD	129		01.07	02.10					
	2.0	136		07.00	07.01					
	2.0 t			10.98	02.10					
	2.0 t	110		10.98	02.10					
	2.0 t BioPower			06.06	02.10					
	2.0 t BioPower	110		01.06	02.10					
	2.2 TiD	88		03.02	02.10					
	2.3 t	125		10.98	02.10					
	2.3 t	136		01.01	02.10					
	2.3 T	162		07.03	02.10	- (USA)				
	2.3 T	162	43510123		02.10	+ (USA)				
	2.3 t BioPower	136		01.07	02.10					
	2.3 t BioPower	152		11.06	02.10					
	2.3 t BioPower	154		01.07	02.10					
	3.0 t	147		10.98	02.10					
	2.0	136		07.00	07.01		BAR25142		+ 16" Rad <sup>1)</sup>	308 25,0 22,0 V L
	2.0 t			10.98	02.10					
	2.0 t	110		10.98	02.10					
	2.3	224		06.03	08.05					
	2.3 t	125		10.98	02.10					
	2.3 T	162	43510122	07.03		+ (USA)				
	2.3 T	188		04.08	02.10					
	2.3 T	191		01.06	02.10					
	2.3 T Aero	169		10.99	09.01					
	2.3 T Aero	184		09.01	02.10					
	2.3 T Aero	225		04.03	03.04					
	2.3 t BioPower	136		01.07	02.10					
	2.3 t BioPower	152		11.06	02.10					

<sup>1)</sup> + 16" wheel / + ruota 16" / + roue 16" / + rueda 16"

<sup>2)</sup> + 15" wheel / + ruota 15" / + roue 15" / + rueda 15"

SAAB 9-5 Kombi (YS3E) (98-10)									
	2.3 t BioPower 3.0 t 3.0 TiD	154 147 130		01.07 10.98 07.01	02.10 02.10 02.10	BAR25142		+ 16" Rad 1)	308 25,0 22,0 V L
	2.0 2.0 t 2.0 t 2.0 t BioPower 2.0 t BioPower 2.3 t 2.3 t BioPower 2.3 t BioPower 2.3 t BioPower 3.0 t	136 110 110 110 125 136 152 154 147	X3025751 X3025751 X3025751 X3025751 X3025751 X3025751 X3025751 X3025751 X3025751	07.00 10.98 10.98 06.06 01.06 10.98 01.07 11.06 01.07 10.98		BA2095			21050 15,7 ATE
	1.9 TiD 1.9 TiD 2.0 2.0 t 2.0 t 2.0 t BioPower 2.0 t BioPower 2.2 TiD 2.3 2.3 t 2.3 t 2.3 T 2.3 T 2.3 T 2.3 T Aero 2.3 T Aero 2.3 T Aero 2.3 t BioPower 2.3 t BioPower 2.3 t BioPower 3.0 t 3.0 TiD	110 129 136 110 110 110 88 224 125 136 162 188 191 169 184 225 136 152 154 147 130	X3025752 X3025752	01.06 01.07 07.01 02.10 02.10 02.10 02.10 03.02 06.03 01.01 07.03 04.08 01.06 10.99 09.01 04.03 02.10 02.10 02.10 02.10 07.01	02.10 02.10 07.01 02.10 02.10 02.10 02.10 02.10 08.05 02.10 02.10 02.10 02.10 09.01 02.10 03.04 02.10 02.10 02.10 02.10 02.10	BA2053			20180 17,3 +/-WE ATE
	2.0 2.0 t 2.0 t 2.0 t BioPower 2.0 t BioPower 2.3 t 2.3 t BioPower 2.3 t BioPower 3.0 t	136 110 110 110 125 136 152 154 147	X3025751 X3025751 X3025751 X3025751 X3025751 X3025751 X3025751 X3025751 X3025751	07.00 10.98 10.98 06.06 01.06 10.98 01.07 11.06 01.07 10.98		BAR10226			286 10,0 8,0
SAAB 900 (94-98)									
	2.0 16V Turbo 2.0 i 2.3 16V 2.5 V6			09.96 09.96 09.96 09.96	03.98 03.98 03.98 03.98	BA2207 BAV1014	2		21829 20,3 +/-WE ATE Warnkontakt L=740mm
	2.0 16V Turbo 2.0 i 2.3 16V 2.5 V6			09.96 09.96 09.96 09.96	03.98 03.98 03.98 03.98	BAR25119			288 25,0 22,0 V L
	2.0 16V Turbo 2.0 i 2.3 16V 2.5 V6			09.93 09.93 09.93 09.93	08.96 08.96 08.96 08.96	BA2098			21140 15,7 ATE
	2.0 16V Turbo 2.0 i 2.3 16V 2.5 V6			09.96 09.96 09.96 09.96	03.98 03.98 03.98 03.98	BA2095			21050 15,7 ATE
	2.0 16V Turbo 2.0 16V Turbo 2.0 i 2.0 i 2.3 16V 2.3 16V 2.5 V6 2.5 V6	V2022962 V7004690 V2022962 V7004690 V2022962 V7004690 V2022962 V7004690		03.98 03.98 03.98 03.98 03.98 03.98 03.98 03.98		BAR10226			286 10,0 8,0
SEAT ALHAMBRA I (7V) (96-10)									
	1.8 T 20V 1.9 TDI 1.9 TDI 2.0 i	110 66 81 85	7M-W-070000 7M-W-070000 7M-W-070000 7M-W-070000	05.98 03.96 10.97 03.96		BA2147 BA2269			21848 19,5 + 21849 19,6 +/-WK ATE ATE
	1.8 T 20V 1.9 TDI 1.9 TDI 1.9 TDI 2.0 i	110 66 81 85 85	7M-X-000001 7M-X-000001 7M-X-000001 7M-X-000001 7M-X-000001	05.00		BA2269			21849 19,6 +/-WK ATE
	1.9 TDI 1.9 TDI 1.9 TDI 2.0 i	66 85 96 85	7M-2-500001 7M-2-500001 7M-2-500001 7M-2-500001	08.10 08.10 11.02 08.10		BA2231			23418 19,6 +/-WK ATE

1) + 16" wheel / + ruota 16" / + roue 16" / + rueda 16"





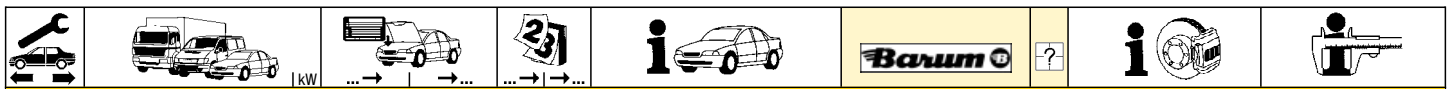







											
<b>SEAT ALHAMBRA I (7V) (96-10)</b>											
	2.0 TDI	103		11.05	08.10		BA2231		23418 19,6 +/WK	ATE	
	1.8 T 20V	110	7M-2-500001				BA2318		23269 20,1 +/WK	ATE	
	1.9 TDI	110		05.05	08.10						
	1.9 TDI 4motion	85		02.01	08.10						
	1.9 TDI 4motion	96		06.05	08.10						
	2.8 i V6	150		06.00	08.10						
	2.8 i V6 4motion	150		02.01	08.10						
	1.8 T 20V	110		05.98			BAR25114		288 25,0 21,0 V L		
	1.9 TDI	66	7M-1-530756	03.96							
	1.9 TDI	81		10.97	05.00						
	1.9 TDI	85	7M-1-530756	06.00							
	2.0 i	85	7M-1-530756	03.96							
	1.9 TDI	66	7M-2-500001			08.10		BAR26115		300 26,0 22,0 V L	
	1.8 T 20V	110		05.98			BAH0007	2	L=450		
	1.9 TDI	66	7M-1-530756	03.96							
	1.9 TDI	81		10.97	05.00						
	1.9 TDI	85	7M-1-530756	06.00							
	1.9 TDI	96	7M-1-530756	11.02							
	1.9 TDI 4motion	96	7M-1-530756	06.05							
	2.0 i	85	7M-1-530756	03.96							
	1.8 T 20V	110	7M-2-500001			08.10		BAH0027	2	L=455	
	1.9 TDI	66	7M-2-500001			08.10					
	1.9 TDI	85	7M-2-500001			08.10					
	1.9 TDI	96	7M-2-500001			08.10					
	1.9 TDI	110		05.05	08.10						
	1.9 TDI 4motion	85		02.01	08.10						
1.9 TDI 4motion	96	7M-2-500001			08.10						
2.0 i	85	7M-2-500001			08.10						
2.0 TDI	103		11.05	08.10							
2.8 i V6	150		06.00	08.10							
2.8 i V6 4motion	150		02.01	08.10							
	1.8 T 20V	110		05.98	05.00		BA2017		20961 17,2 /S	LUC	
	1.9 TDI	66		03.96	05.00						
	1.9 TDI	81		10.97	05.00						
	2.0 i	85		03.96	05.00						
	1.8 T 20V	110	7M-1-530756	06.00			BA2228		20961 17,2 +/WK/S	LUC	
	1.9 TDI	66		06.00	08.10						
	1.9 TDI	85		06.00	08.10						
	1.9 TDI	96		11.02	08.10						
	2.0 i	85		06.00	08.10						
	2.0 TDI	103		11.05	08.10						
	1.8 T 20V	110	7M-2-500001				BA2200		23446 16,5 +/WK/S	LUC	
	1.9 TDI	110		05.05	08.10						
	1.9 TDI 4motion	85		02.01	08.10						
	1.9 TDI 4motion	96		06.05	08.10						
	2.8 i V6	150		06.00	08.10						
	2.8 i V6 4motion	150		02.01	08.10						
		1.8 T 20V	110	7M-1-530756	05.98			BAR10223		268 9,9 8,0	
		1.9 TDI	66		03.96	08.10					
		1.9 TDI	81		10.97	05.00					
		1.9 TDI	85		06.00	08.10					
1.9 TDI		96		11.02	08.10						
2.0 i		85		03.96	08.10						
2.0 TDI		103		11.05	08.10						
	1.8 T 20V	110	7M-2-500001				BAR13194		294 13,5 11,5		
	1.9 TDI	110		05.05	08.10						
	1.9 TDI 4motion	85		02.01	08.10						
	1.9 TDI 4motion	96		06.05	08.10						
	2.8 i V6	150		06.00	08.10						
	2.8 i V6 4motion	150		02.01	08.10						
	<b>SEAT ALHAMBRA II (10-)</b>										
	1.4 TSI	110		09.10		PR: 1LJ	BAR25158		312 25,0 22,0 V L		
	2.0 TDI			09.10		PR: 1LJ					
	2.0 TDI	85		04.11		PR: 1LJ					
	2.0 TDI	125		09.10		PR: 1LJ					
	2.0 TDI 4motion	103		04.11		PR: 1LJ					
2.0 TSI	147		09.10		PR: 1LJ						
	1.4 TSI	110		09.10			BAR12169		282 12,0 10,0		
	2.0 TDI			09.10							
	2.0 TDI	85		04.11							
	2.0 TDI	125		09.10							
	2.0 TDI 4motion	103		04.11							
2.0 TSI	147		09.10								
<b>SEAT ALTEA (5P1) (04-)</b>											
	1.2 TSI	77		04.10			BA2155		23131 19,6 +/WK	VW	
	1.4 i 16V	63		05.06							
	1.4 TSI	92		11.07							
	1.6 i 16V	75		03.04							
	1.6 LPG	75		09.09							
	1.6 TDI			10.09							

































**SEAT ALTEA (5P1) (04-)**

	1.8 TFSI	118		01.07	PR: 1ZF	BA2155		23131 19,6 +/WK	VW
	1.9 TDI			03.04	PR: 1ZF				
	2.0 FSI	110		03.04	PR: 1ZF				
	2.0 i 16V	100		03.04	PR: 1ZF				
	2.0 TDI	100		03.04	PR: 1ZF				
	2.0 TDI	103		03.04	PR: 1ZF				
	2.0 TDI	125		03.06	PR: 1ZF				
	2.0 TFSI	147		03.06	PR: 1ZF				
	1.2 TSI	77		04.10	PR: 1ZA,1ZE,1LJ				
	1.4 i 16V	63		05.06	PR: 1ZA,1ZE,1LJ				
1.4 TSI	92		11.07	PR: 1ZA,1ZE,1LJ					
1.6 i 16V	75		03.04	PR: 1ZA,1ZE,1LJ					
1.6 LPG	75		09.09	PR: 1ZA,1ZE,1LJ					
1.6 TDI			10.09	PR: 1ZA,1ZE,1LJ					
1.8 TFSI	118		01.07	PR: 1ZA,1ZE,1LJ					
1.9 TDI			03.04	PR: 1ZA,1ZE,1LJ					
2.0 FSI	110		03.04	PR: 1ZA,1ZE,1LJ					
2.0 i 16V	100		03.04	PR: 1ZA,1ZE,1LJ					
2.0 TDI	100		03.04	PR: 1ZA,1ZE,1LJ					
2.0 TDI	103		03.04	PR: 1ZA,1ZE,1LJ					
2.0 TDI	125		03.06	PR: 1ZA,1ZE,1LJ					
2.0 TFSI	147		03.06	PR: 1ZA,1ZE,1LJ					
	1.2 TSI	77		04.10	PR: 1ZF	BAR22210		280 22,0 19,0 V L	
	1.4 i 16V	63		05.06	PR: 1ZF				
	1.4 TSI	92		11.07	PR: 1ZF				
	1.6 i 16V	75		03.04	PR: 1ZF				
	1.6 LPG	75		09.09	PR: 1ZF				
	1.6 TDI			10.09	PR: 1ZF				
	1.8 TFSI	118		01.07	PR: 1ZF				
	1.9 TDI			03.04	PR: 1ZF				
	2.0 FSI	110		03.04	PR: 1ZF				
	2.0 i 16V	100		03.04	PR: 1ZF				
2.0 TDI	100		03.04	PR: 1ZF					
2.0 TDI	103		03.04	PR: 1ZF					
2.0 TDI	125		03.06	PR: 1ZF					
2.0 TFSI	147		03.06	PR: 1ZF					
	1.2 TSI	77		04.10	PR: 1ZE	BAR25145		288 24,9 22,0 V L	
	1.4 i 16V	63		05.06	PR: 1ZE				
	1.4 TSI	92		11.07	PR: 1ZE				
	1.6 i 16V	75		03.04	PR: 1ZE				
	1.6 LPG	75		09.09	PR: 1ZE				
	1.6 TDI			10.09	PR: 1ZE				
	1.8 TFSI	118		01.07	PR: 1ZE				
	1.9 TDI			03.04	PR: 1ZE				
	2.0 FSI	110		03.04	PR: 1ZE				
	2.0 i 16V	100		03.04	PR: 1ZE				
2.0 TDI	100		03.04	PR: 1ZE					
2.0 TDI	103		03.04	PR: 1ZE					
2.0 TDI	125		03.06	PR: 1ZE					
2.0 TFSI	147		03.06	PR: 1ZE					
	1.2 TSI	77		04.10	PR: 1LJ,1ZA	BAR25158		312 25,0 22,0 V L	
	1.4 i 16V	63		05.06	PR: 1LJ,1ZA				
	1.4 TSI	92		11.07	PR: 1LJ,1ZA				
	1.6 i 16V	75		03.04	PR: 1LJ,1ZA				
	1.6 LPG	75		09.09	PR: 1LJ,1ZA				
	1.6 TDI			10.09	PR: 1LJ,1ZA				
	1.8 TFSI	118		01.07	PR: 1LJ,1ZA				
	1.9 TDI			03.04	PR: 1LJ,1ZA				
	2.0 FSI	110		03.04	PR: 1LJ,1ZA				
	2.0 i 16V	100		03.04	PR: 1LJ,1ZA				
2.0 TDI	100		03.04	PR: 1LJ,1ZA					
2.0 TDI	103		03.04	PR: 1LJ,1ZA					
2.0 TDI	125		03.06	PR: 1LJ,1ZA					
2.0 TFSI	147		03.06	PR: 1LJ,1ZA					
	1.2 TSI	77		04.10	PR: 1KD,1KQ,1KZ	BA2017		20961 17,2 /S	LUC
	1.4 i 16V	63		05.06	PR: 1KD,1KQ,1KZ				
	1.4 TSI	92		11.07	PR: 1KD,1KQ,1KZ				
	1.6 i 16V	75		03.04	PR: 1KD,1KQ,1KZ				
	1.6 LPG	75		09.09	PR: 1KD,1KQ,1KZ				
	1.6 TDI			10.09	PR: 1KD,1KQ,1KZ				
	1.8 TFSI	118		01.07	PR: 1KD,1KQ,1KZ				
	1.9 TDI			03.04	PR: 1KD,1KQ,1KZ				
	2.0 FSI	110		03.04	PR: 1KD,1KQ,1KZ				
	2.0 i 16V	100		03.04	PR: 1KD,1KQ,1KZ				
2.0 TDI	100		03.04	PR: 1KD,1KQ,1KZ					
2.0 TDI	103		03.04	PR: 1KD,1KQ,1KZ					
2.0 TDI	125		03.06	PR: 1KD,1KQ,1KZ					
2.0 TFSI	147		03.06	PR: 1KD,1KQ,1KZ					
	1.2 TSI	77		04.10	PR: 1KD,1KQ,1KZ	BA2196		23914 16,3 /WE/S	LUC
	1.4 i 16V	63		05.06	PR: 1KD,1KQ,1KZ				
	1.4 TSI	92		11.07	PR: 1KD,1KQ,1KZ				
	1.6 i 16V	75		03.04	PR: 1KD,1KQ,1KZ				
	1.6 LPG	75		09.09	PR: 1KD,1KQ,1KZ				
	1.6 TDI			10.09	PR: 1KD,1KQ,1KZ				
	1.8 TFSI	118		01.07	PR: 1KD,1KQ,1KZ				
	1.9 TDI			03.04	PR: 1KD,1KQ,1KZ				
	2.0 FSI	110		03.04	PR: 1KD,1KQ,1KZ				
	↓	↓		↓					

								
<b>SEAT ALTEA (5P1) (04-)</b>								
	2.0 i 16V 2.0 TDI 2.0 TDI 2.0 TDI 2.0 TFSI	100 100 103 125 147	03.04 03.04 03.04 03.06 03.06	PR: 1KD,1KQ,1KZ PR: 1KD,1KQ,1KZ PR: 1KD,1KQ,1KZ PR: 1KD,1KQ,1KZ PR: 1KD,1KQ,1KZ	BA2196			23914 16,3 /WE/S LUC
	1.2 TSI 1.4 i 16V 1.4 TSI 1.6 i 16V 1.6 LPG 1.6 TDI 1.8 TFSI 1.9 TDI 2.0 FSI 2.0 i 16V 2.0 TDI 2.0 TDI 2.0 TDI 2.0 TFSI	77 63 92 75 75 118 110 100 100 103 125 147	04.10 05.06 11.07 03.04 09.09 10.09 01.07 03.04 03.04 03.04 03.04 03.04 03.06	PR: 1KJ,1KZ PR: 1KJ,1KZ PR: 1KJ,1KZ PR: 1KJ,1KZ PR: 1KJ,1KZ PR: 1KJ,1KZ PR: 1KJ,1KZ PR: 1KJ,1KZ PR: 1KJ,1KZ PR: 1KJ,1KZ PR: 1KJ,1KZ PR: 1KJ,1KZ PR: 1KJ,1KZ	BAR12169			282 12,0 10,0
<b>SEAT ALTEA XL (5P5) (06-)</b>								
	1.2 TSI 1.4 i 16V 1.4 TSI 1.6 i 16V 1.6 LPG 1.6 TDI 1.8 TFSI 1.9 TDI 2.0 FSI 2.0 TDI 2.0 TDI 2.0 TDI 4x4 2.0 TFSI 4x4	77 63 92 75 75 118 110 125	04.10 05.08 11.07 10.06 09.09 10.09 10.06 10.06 10.06 10.06 10.06 06.07 06.07	PR: 1ZF PR: 1ZF PR: 1ZF PR: 1ZF PR: 1ZF PR: 1ZF PR: 1ZF PR: 1ZF PR: 1ZF PR: 1ZF PR: 1ZF PR: 1ZF	BA2155			23131 19,6 +/WK VW
	1.2 TSI 1.4 i 16V 1.4 TSI 1.6 i 16V 1.6 LPG 1.6 TDI 1.8 TFSI 1.9 TDI 2.0 FSI 2.0 TDI 2.0 TDI 2.0 TDI 4x4 2.0 TFSI 4x4	77 63 92 75 75 118 110 125	04.10 05.08 11.07 10.06 09.09 10.09 10.06 10.06 10.06 10.06 10.06 06.07 06.07	PR: 1ZA,1ZE,1LJ PR: 1ZA,1ZE,1LJ PR: 1ZA,1ZE,1LJ PR: 1ZA,1ZE,1LJ PR: 1ZA,1ZE,1LJ PR: 1ZA,1ZE,1LJ PR: 1ZA,1ZE,1LJ PR: 1ZA,1ZE,1LJ PR: 1ZA,1ZE,1LJ PR: 1ZA,1ZE,1LJ PR: 1ZA,1ZE,1LJ PR: 1ZA,1ZE,1LJ	BA2195			23587 19,6 +/WK ATE
	1.2 TSI 1.4 i 16V 1.4 TSI 1.6 i 16V 1.6 LPG 1.6 TDI 1.8 TFSI 1.9 TDI 2.0 FSI 2.0 TDI 2.0 TDI 2.0 TDI 4x4 2.0 TFSI 4x4	77 63 92 75 75 118 110 125	04.10 05.08 11.07 10.06 09.09 10.09 10.06 10.06 10.06 10.06 10.06 06.07 06.07	PR: 1ZF PR: 1ZF PR: 1ZF PR: 1ZF PR: 1ZF PR: 1ZF PR: 1ZF PR: 1ZF PR: 1ZF PR: 1ZF PR: 1ZF PR: 1ZF	BAR22210			280 22,0 19,0 V L
	1.2 TSI 1.4 i 16V 1.4 TSI 1.6 i 16V 1.6 LPG 1.6 TDI 1.8 TFSI 1.9 TDI 2.0 FSI 2.0 TDI 2.0 TDI 2.0 TDI 4x4 2.0 TFSI 4x4	77 63 92 75 75 118 110 125	04.10 05.08 11.07 10.06 09.09 10.09 10.06 10.06 10.06 10.06 10.06 06.07 06.07	PR: 1ZE PR: 1ZE PR: 1ZE PR: 1ZE PR: 1ZE PR: 1ZE PR: 1ZE PR: 1ZE PR: 1ZE PR: 1ZE PR: 1ZE PR: 1ZE	BAR25145			288 24,9 22,0 V L
	1.2 TSI 1.4 i 16V 1.4 TSI 1.6 i 16V 1.6 LPG 1.6 TDI 1.8 TFSI 1.9 TDI 2.0 FSI 2.0 TDI 2.0 TDI 2.0 TDI 4x4 2.0 TFSI 4x4	77 63 92 75 75 118 110 125	04.10 05.08 11.07 10.06 09.09 10.09 10.06 10.06 10.06 10.06 10.06 06.07 06.07	PR: 1LJ,1ZA PR: 1LJ,1ZA PR: 1LJ,1ZA PR: 1LJ,1ZA PR: 1LJ,1ZA PR: 1LJ,1ZA PR: 1LJ,1ZA PR: 1LJ,1ZA PR: 1LJ,1ZA PR: 1LJ,1ZA PR: 1LJ,1ZA PR: 1LJ,1ZA	BAR25158			312 25,0 22,0 V L

	   kW							
<b>SEAT ALTEA XL (5P5) (06-)</b>								
	1.2 TSI	77	04.10	PR: 1KD,1KQ,1KZ	BA2017			20961 17,2 /S LUC
	1.4 i 16V	63	05.08	PR: 1KD,1KQ,1KZ				
	1.4 TSI	92	11.07	PR: 1KD,1KQ,1KZ				
	1.6 i 16V	75	10.06	PR: 1KD,1KQ,1KZ				
	1.6 LPG	75	09.09	PR: 1KD,1KQ,1KZ				
	1.6 TDI		10.09	PR: 1KD,1KQ,1KZ				
	1.8 TFSI	118	10.06	PR: 1KD,1KQ,1KZ				
	1.9 TDI		10.06	PR: 1KD,1KQ,1KZ				
	2.0 FSI	110	10.06	PR: 1KD,1KQ,1KZ				
	2.0 TDI		10.06	PR: 1KD,1KQ,1KZ				
2.0 TDI 4x4	125	10.06	PR: 1KD,1KQ,1KZ					
2.0 TDI 4x4		06.07	PR: 1KD,1KQ,1KZ					
2.0 TFSI 4x4		06.07	PR: 1KD,1KQ,1KZ					
	1.2 TSI	77	04.10	PR: 1KD,1KQ,1KZ	BA2196			23914 16,3 /WE/S LUC
	1.4 i 16V	63	05.08	PR: 1KD,1KQ,1KZ				
	1.4 TSI	92	11.07	PR: 1KD,1KQ,1KZ				
	1.6 i 16V	75	10.06	PR: 1KD,1KQ,1KZ				
	1.6 LPG	75	09.09	PR: 1KD,1KQ,1KZ				
	1.6 TDI		10.09	PR: 1KD,1KQ,1KZ				
	1.8 TFSI	118	10.06	PR: 1KD,1KQ,1KZ				
	1.9 TDI		10.06	PR: 1KD,1KQ,1KZ				
	2.0 FSI	110	10.06	PR: 1KD,1KQ,1KZ				
	2.0 TDI		10.06	PR: 1KD,1KQ,1KZ				
2.0 TDI 4x4	125	10.06	PR: 1KD,1KQ,1KZ					
2.0 TDI 4x4		06.07	PR: 1KD,1KQ,1KZ					
2.0 TFSI 4x4		06.07	PR: 1KD,1KQ,1KZ					
	1.2 TSI	77	04.10	PR: 1KJ,1KZ	BAR12169			282 12,0 10,0
	1.4 i 16V	63	05.08	PR: 1KJ,1KZ				
	1.4 TSI	92	11.07	PR: 1KJ,1KZ				
	1.6 i 16V	75	10.06	PR: 1KJ,1KZ				
	1.6 LPG	75	09.09	PR: 1KJ,1KZ				
	1.6 TDI		10.09	PR: 1KJ,1KZ				
	1.8 TFSI	118	10.06	PR: 1KJ,1KZ				
	1.9 TDI		10.06	PR: 1KJ,1KZ				
	2.0 FSI	110	10.06	PR: 1KJ,1KZ				
	2.0 TDI		10.06	PR: 1KJ,1KZ				
2.0 TDI 4x4	125	10.06	PR: 1KJ,1KZ					
2.0 TDI 4x4		06.07	PR: 1KJ,1KZ					
2.0 TFSI 4x4		06.07	PR: 1KJ,1KZ					
<b>SEAT AROSA (6H) (97-05)</b>								
	1.0 i	37	05.97	04.05	BA2152			21866 17,3 + VW
	1.4 i	44	05.97	04.05				
	1.7 SDI	44	11.97	04.05	BA2018			21945 16,3 /S LUC
	1.4 i 16V	74	10.99	04.05				
	1.4 TDI	55	10.99	04.05	BAR10232			239 10,0 8,0 L
	1.0 i	37	05.97	04.05				
	1.0 i	37	05.97	04.05	BAR18106			240 18,0 16,0 V L
	1.4 i	44	05.97	04.05				
	1.7 SDI	44	11.97	04.05	BAR20128			256 20,0 18,0 V L
	1.4 i 16V	74	10.99	04.05				
	1.4 TDI	55	10.99	04.05	BAH0019	2		L=380
	1.0 i	37	05.97	04.05				
	1.4 i	44	05.97	04.05	BA2017			20961 17,2 /S LUC
	1.4 i 16V	74	10.99	04.05				
	1.4 TDI	55	10.99	04.05	BAR09124			232 8,9 7,0
	1.7 SDI	44	11.97	04.05				
	1.0 i	37	05.97	04.05	BAH0033	2		L=140
	1.4 i	44	05.97	04.05				
	1.4 i 16V	74	10.99	04.05	BAW1501			Rz 15,87
	1.4 TDI	55	10.99	04.05				
	1.7 SDI	44	11.97	04.05	BAW1701			Rz 17,46
	1.0 i	37	05.97	04.05				
	1.4 i	44	05.97	04.05	BAE5003			180 x 31 HEB
	1.4 TDI	55	10.99	04.05				
	1.7 SDI	44	11.97	04.05	BAE5001			200 x 40 HEB VW
	1.0 i	37	05.97	04.05				
	1.4 i	44	05.97	04.05	BAE5001			200 x 40 HEB VW
	1.4 TDI	55	10.99	04.05				
	1.7 SDI	44	11.97	04.05	BAE5001			200 x 40 HEB VW
	1.0 i	37	05.97	04.05				
	1.4 i	44	05.97	04.05	BAE5001			200 x 40 HEB VW
	1.4 TDI	55	10.99	04.05				
	1.7 SDI	44	11.97	04.05	BAE5001			200 x 40 HEB VW
	1.0 i	37	05.97	04.05				

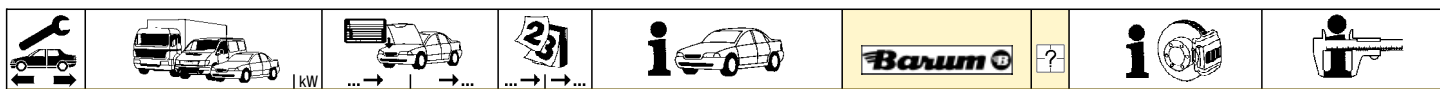



















**SEAT CORDOBA I (93-99)**

	1.4 i		11.93	05.99	- ABS	BA2131		20889	17,3 /Zub	VW	
	1.4 i		11.93	05.99	+ ABS	BA2132		20887	19,7 +/Zub	VW	
	1.6 i		11.93	05.99							
	1.8 i		11.93	05.99							
	1.9 D		6K-ZR003620	11.93							
	1.9 D		6K-ZR003611	11.93							
	1.9 TD		6K-ZR003513	11.93							
	1.7 SDI			07.97	05.99		BA2153		21866	15,3 +	VW
	1.8 i	6K-ZR003621			05.99						
	1.9 D	6K-ZR003612			05.99						
1.9 SDI			09.95	05.99							
1.9 TD	6K-ZR003514			05.99							
	1.6 i		11.93	05.99		BA2037		20168	16,3 /S	LUC	
	1.8 i		11.93	05.99							
	1.8 i 16V		02.94	05.99							
	2.0 i		11.93	05.99							
	1.9 TDI	66		07.96	05.99	BA2018		21945	16,3 /S	LUC	
	1.9 TDI	81		03.97	05.99						
	2.0 i 16V			07.96	05.99	BA2038		20168	19,6 /S	LUC	
	1.4 i		11.93	05.99	- ABS	BAR10151		239	9,9 8,0		
	1.4 i		11.93	05.99	+ ABS	BAR12106		239	12,0 10,0		
	1.8 i		6K-ZR003620	11.93							
1.9 D		6K-ZR003611	11.93								
1.9 TD		6K-ZR003513	11.93								
	1.6 i		11.93	05.99		BAR20123		239	20,0 18,0 V L		
	1.7 SDI		07.97	05.99							
	1.8 i	6K-ZR003621		05.99							
	1.9 D	6K-ZR003612		05.99							
	1.9 SDI		09.95	05.99							
	1.9 TD	6K-ZR003514		05.99							
	1.6 i		11.93	05.99		BAR20128		256	20,0 18,0 V L		
	1.8 i		11.93	05.99							
	1.8 i 16V		02.94	05.99							
	1.9 TDI	66		07.96	05.99						
1.9 TDI	81		03.97	05.99							
2.0 i		11.93	05.99								
	1.4 i		11.93			BAH0005	2		L=435		
	1.4 i		11.93								
	1.6 i		11.93								
	1.6 i		11.93								
	1.7 SDI		07.97								
	1.7 SDI		07.97								
	1.8 i		11.93								
	1.8 i		11.93								
	1.8 i 16V		02.94								
	1.8 i 16V		02.94								
	1.9 D		11.93								
	1.9 D		11.93								
	1.9 SDI		09.95								
	1.9 SDI		09.95								
	1.9 TD		11.93								
	1.9 TD		11.93								
	1.9 TDI	66		07.96							
1.9 TDI	66		07.96								
1.9 TDI	81		03.97								
1.9 TDI	81		03.97								
2.0 i		11.93									
2.0 i		11.93									
	1.8 i 16V		02.94	05.99		BA2032		20961	15,2 /S	LUC	
	1.9 TDI	81		03.97	05.99						
	2.0 i		11.93	05.99							
	2.0 i 16V		07.96	05.99		BA2017		20961	17,2 /S	LUC	
	1.8 i 16V		02.94	05.99		BAR10111		ohne Sensorring <sup>1)</sup>	226	10,0 8,0	
	1.9 TDI	81		03.97	05.99						
	2.0 i		11.93	05.99							
	2.0 i 16V		07.96	05.99							
	1.4 i		11.93	05.99		BAH0016	2		L=135		
	1.6 i		11.93	05.99							
	1.7 SDI		07.97	05.99							
	1.8 i		11.93	05.99							
	1.9 D		11.93	05.99							
	1.9 SDI		09.95	05.99							
	1.9 TD		11.93	05.99							
	1.9 TDI	66		07.96	05.99						
	1.8 i 16V		02.94	05.99		BAH0003	2		L=160		
	1.9 TDI	81		03.97	05.99						
	2.0 i		11.93	05.99							
	1.4 i		11.93	05.99		BAW1701		+ GG <sup>2)</sup>	Rz	17,46	
	1.6 i		11.93	05.99							
	1.7 SDI		07.97	05.99							
	1.8 i		11.93	05.99							
	1.9 D		11.93	05.99							
	1.9 TDI	66		07.96	05.99						

<sup>1)</sup> without sensor ring / senza sensori / sans secours ABS / sin anillo sensor ABS

<sup>2)</sup> + cast iron / + ghisa / + fonte grise / + fundición de gris

								
<b>SEAT CORDOBA I (93-99)</b>								
	1.4 i 1.6 i		11.93 05.99 11.93 05.99	- ABS - ABS	BAE5003			180 x 31 HEB
	1.4 i 1.6 i 1.7 SDI 1.8 i 1.9 D 1.9 SDI 1.9 TD 1.9 TDI		11.93 05.99 11.93 05.99 07.97 05.99 11.93 05.99 11.93 05.99 09.95 05.99 11.93 05.99 07.96 05.99	+ ABS + ABS	BAE5001			200 x 40 HEB <b>VW</b>
		66						
<b>SEAT CORDOBA II (6K2) (99-02)</b>								
	1.0 1.4 i 1.4 i 16V 1.6 i 1.9 SDI	37 44 55	06.99 09.02 06.99 09.02 06.99 09.02 06.99 09.02		BA2153			21866 15,3 + <b>VW</b>
	1.6 i 1.9 TDI	74 66	06.99 09.02 06.99 09.02		BA2018			21945 16,3 /S <b>LUC</b>
	1.8 T 20V 1.9 TDI	115 81	07.00 09.02 06.99 09.02		BA2038			20168 19,6 /S <b>LUC</b>
	1.0 1.4 i 1.4 i 16V 1.6 i 1.9 SDI	37 44 55	06.99 09.02 06.99 09.02 06.99 09.02 06.99 09.02		BAR20123			239 20,0 18,0 V L
	1.6 i 1.9 TDI	74 66	06.99 09.02 06.99 09.02		BAR20128			256 20,0 18,0 V L
	1.0 1.4 i 1.4 i 16V 1.6 i 1.8 T 20V 1.9 SDI 1.9 TDI 1.9 TDI	37 44 115 66 81	06.99 09.02 06.99 09.02 06.99 09.02 06.99 09.02 07.00 09.02 06.99 09.02 06.99 09.02		BAH0005	2		L=435
	1.8 T 20V 1.9 TDI	115 81	07.00 09.02 06.99 09.02		BA2017			20961 17,2 /S <b>LUC</b>
	1.8 T 20V 1.9 TDI	115 81	07.00 09.02 06.99 09.02		BAR09124			232 8,9 7,0
	1.0 1.4 i 1.4 i 16V 1.6 i 1.8 T 20V 1.9 SDI 1.9 TDI 1.9 TDI	37 44 115 66 81	06.99 09.02 06.99 09.02 06.99 09.02 06.99 09.02 07.00 09.02 06.99 09.02 06.99 09.02		BAH0033	2		L=140
	1.0 1.4 i 1.4 i 16V 1.6 i 1.9 SDI 1.9 TDI	37 44 55 66	06.99 09.02 06.99 09.02 06.99 09.02 06.99 09.02		BAW1701			Rz 17,46
	1.6 i	74	06.99 09.02		BAW1905			Rz 19,05
	1.0 1.4 i 1.4 i 16V 1.6 i 1.9 SDI 1.9 TDI	37 44 66	06.99 09.02 06.99 09.02 06.99 09.02 06.99 09.02		BAE5001			200 x 40 HEB <b>VW</b>
<b>SEAT CORDOBA III (6L2) (02-09)</b>								
	1.2 i 1.4 i 16V 1.4 i 16V 1.4 TDI 1.6 i 16V 1.9 SDI 1.9 TDI 1.9 TDI 2.0 i 16V	47 74 47 74 96 85	10.02 06.09 10.02 06.09 10.02 06.09 10.02 06.09 02.03 06.09 10.02 06.09 10.02 06.09 10.02 06.09	PR: 1LQ,1ZF PR: 1LQ,1ZF PR: 1LQ,1ZF PR: 1LQ,1ZF PR: 1LQ,1ZF PR: 1LQ,1ZF	BA2154			23130 19,6 + <b>VW</b>
	1.2 i 1.4 i 16V 1.4 i 16V 1.4 TDI 1.6 i 16V 1.9 SDI 1.9 TDI 1.9 TDI 2.0 i 16V	47 74 47 74 96 85	10.02 06.09 10.02 06.09 10.02 06.09 10.02 06.09 02.03 06.09 10.02 06.09 10.02 06.09 10.02 06.09	PR: 1LN,1ZH PR: 1LN,1ZH PR: 1LN,1ZH PR: 1LN,1ZH PR: 1LN,1ZH PR: 1LN,1ZH	BA2298			23843 18,8 +/-WK/S <b>LUC</b>

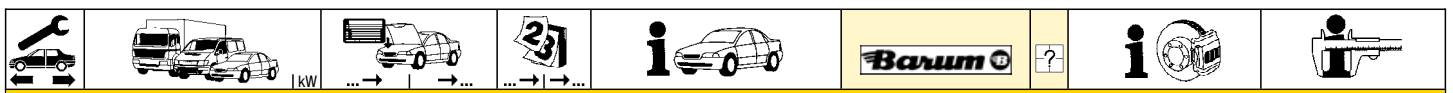

**SEAT CORDOBA III (6L2) (02-09)**

	1.2 i	47		10.02	06.09	PR: 1LQ,1ZF	BAR22151		256 22,0 19,0 V L
	1.4 i 16V			10.02	06.09	PR: 1LQ,1ZF			
	1.4 i 16V	74		10.02	06.09	PR: 1LQ,1ZF			
	1.4 TDI			10.02	06.09	PR: 1LQ,1ZF			
	1.6 i 16V			02.03	06.09	PR: 1LQ,1ZF			
	1.9 SDI	47		10.02	06.09	PR: 1LQ,1ZF			
	1.9 TDI	74		10.02	06.09	PR: 1LQ,1ZF			
	1.9 TDI	96		10.02	06.09	PR: 1LQ,1ZF			
	2.0 i 16V	85		10.02	06.09	PR: 1LQ,1ZF			
	1.2 i	47		10.02	06.09	PR: 1LN,1ZH	BAR25113		288 25,0 22,0 V L
	1.4 i 16V			10.02	06.09	PR: 1LN,1ZH			
	1.4 i 16V	74		10.02	06.09	PR: 1LN,1ZH			
	1.4 TDI			10.02	06.09	PR: 1LN,1ZH			
	1.6 i 16V			02.03	06.09	PR: 1LN,1ZH			
	1.9 SDI	47		10.02	06.09	PR: 1LN,1ZH			
	1.9 TDI	74		10.02	06.09	PR: 1LN,1ZH			
	1.9 TDI	96		10.02	06.09	PR: 1LN,1ZH			
	2.0 i 16V	85		10.02	06.09	PR: 1LN,1ZH			
	1.2 i	47		10.02	06.09		BA2017		20961 17,2 /S LUC
	1.4 i 16V			10.02	06.09				
	1.4 i 16V	74		10.02	06.09				
	1.4 TDI			10.02	06.09				
	1.6 i 16V			02.03	06.09				
	1.9 SDI	47		10.02	06.09				
	1.9 TDI	74		10.02	06.09				
	1.9 TDI	96		10.02	06.09				
	2.0 i 16V	85		10.02	06.09				
	1.2 i	47		10.02	06.09		BAR09123		232 8,9 7,0
	1.4 i 16V			10.02	06.09				
	1.4 i 16V	74		10.02	06.09				
	1.4 TDI			10.02	06.09				
	1.6 i 16V			02.03	06.09				
	1.9 SDI	47		10.02	06.09				
	1.9 TDI	74		10.02	06.09				
	1.9 TDI	96		10.02	06.09				
	2.0 i 16V	85		10.02	06.09				
	1.2 i	47		10.02	06.09		BAH0033	2	L=140
	1.4 i 16V			10.02	06.09				
	1.4 i 16V	74		10.02	06.09				
	1.4 TDI			10.02	06.09				
	1.6 i 16V			02.03	06.09				
	1.9 SDI	47		10.02	06.09				
	1.9 TDI	74		10.02	06.09				
	1.9 TDI	96		10.02	06.09				
	2.0 i 16V	85		10.02	06.09				
	1.2 i	47		10.02	06.09		BAW1905		Rz 19,05
	1.4 i 16V			10.02	06.09				
	1.4 i 16V	74		10.02	06.09				
	1.4 TDI			10.02	06.09				
	1.6 i 16V			02.03	06.09				
	1.9 SDI	47		10.02	06.09				
	1.9 TDI	74		10.02	06.09				
	1.9 TDI	96		10.02	06.09				
	2.0 i 16V	85		10.02	06.09				
	1.2 i	47		10.02	06.09		BAE5001		200 x 40 HEB VW
	1.4 i 16V			10.02	06.09				
	1.4 i 16V	74		10.02	06.09				
	1.4 TDI			10.02	06.09				
	1.6 i 16V			02.03	06.09				
	1.9 SDI	47		10.02	06.09				
	1.9 TDI	74		10.02	06.09				
	1.9 TDI	96		10.02	06.09				
	2.0 i 16V	85		10.02	06.09				

**SEAT EXEO / ST (09-)**

	1.6 i 16V	75		04.09		PR: 1LA	BA2259		23763 19,6 +/WK ATE
	1.8 TFSI	110		04.09		PR: 1LA			
	1.8 TSI	88		09.10		PR: 1LA			
	1.8 TSI	118		05.10		PR: 1LA			
	2.0 TDI	88		04.09		PR: 1LA			
	2.0 TDI	105		04.09		PR: 1LA			
	2.0 TFSI	125		04.09		PR: 1LA			
	1.6 i 16V	75		04.09		PR: 1LB,1LT	BA2172		23018 20,6 +/WK ATE
	1.8 TFSI	110		04.09		PR: 1LB,1LT			
	1.8 TSI	88		09.10		PR: 1LB,1LT			
	1.8 TSI	118		05.10		PR: 1LB,1LT			
	2.0 TDI	88		04.09		PR: 1LB,1LT			
	2.0 TDI	105		04.09		PR: 1LB,1LT			
	2.0 TFSI	125		04.09		PR: 1LB,1LT			
	1.6 i 16V	75		04.09		PR: 1LZ	BA2198		21945 19,6 +/WK/S LUC
	1.8 TFSI	110		04.09		PR: 1LZ			
	1.8 TSI	88		09.10		PR: 1LZ			
	1.8 TSI	118		05.10		PR: 1LZ			
	2.0 TDI	88		04.09		PR: 1LZ			

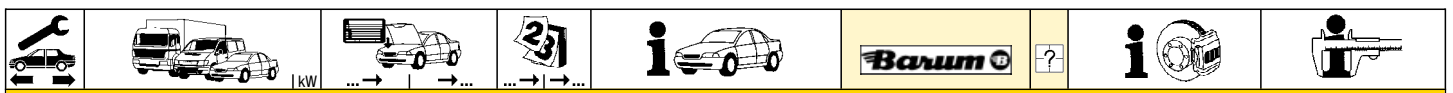

**SEAT EXEO / ST (09-)**

	2.0 TDI 2.0 TDI 2.0 TFSI	105 125	04.09 04.09 04.09	PR: 1LZ PR: 1LZ PR: 1LZ	BA2198		21945 19,6 +/WK/S	LUC
	1.6 i 16V 1.8 TFSI 1.8 TSI 1.8 TSI 2.0 TDI 2.0 TDI 2.0 TFSI	75 110 88 118 88 105 125	04.09 04.09 09.10 05.10 04.09 04.09 04.09	PR: 1LA PR: 1LA PR: 1LA PR: 1LA PR: 1LA PR: 1LA PR: 1LA	BAR30113		320 30,0 28,0 V L	
	1.6 i 16V 1.8 TFSI 1.8 TSI 1.8 TSI 2.0 TDI 2.0 TDI 2.0 TFSI	75 110 88 118 88 105 125	04.09 04.09 09.10 05.10 04.09 04.09 04.09	PR: 1LB PR: 1LB PR: 1LB PR: 1LB PR: 1LB PR: 1LB PR: 1LB	BAR25105		288 24,8 23,0 V L	
	1.6 i 16V 1.8 TFSI 1.8 TSI 1.8 TSI 2.0 TDI 2.0 TDI 2.0 TFSI	75 110 88 118 88 105 125	04.09 04.09 09.10 05.10 04.09 04.09 04.09	PR: 1LT PR: 1LT PR: 1LT PR: 1LT PR: 1LT PR: 1LT PR: 1LT	BAR25137		312 25,0 23,0 V L	
	1.6 i 16V 1.8 TFSI 1.8 TSI 1.8 TSI 2.0 TDI 2.0 TDI 2.0 TFSI	75 110 88 118 88 105 125	04.09 04.09 09.10 05.10 04.09 04.09 04.09	PR: 1LZ PR: 1LZ PR: 1LZ PR: 1LZ PR: 1LZ PR: 1LZ PR: 1LZ	BAR22152		280 22,0 20,0 V L	
	1.6 i 16V 1.8 TFSI 1.8 TSI 1.8 TSI 2.0 TDI 2.0 TDI 2.0 TFSI	75 110 88 118 88 105 125	04.09 04.09 09.10 05.10 04.09 04.09 04.09		BAH0021	2	L=305	
	1.6 i 16V 1.8 TFSI 1.8 TSI 1.8 TSI 2.0 TDI 2.0 TDI 2.0 TFSI	75 110 88 118 88 105 125	04.09 04.09 09.10 05.10 04.09 04.09 04.09	PR: 1KD,1KP PR: 1KD,1KP PR: 1KD,1KP PR: 1KD,1KP PR: 1KD,1KP PR: 1KD,1KP PR: 1KD,1KP	BA2032		20961 15,2 /S	LUC
	1.6 i 16V 1.8 TFSI 1.8 TSI 1.8 TSI 2.0 TDI 2.0 TDI 2.0 TFSI	75 110 88 118 88 105 125	04.09 04.09 09.10 05.10 04.09 04.09 04.09	PR: 1KW PR: 1KW PR: 1KW PR: 1KW PR: 1KW PR: 1KW PR: 1KW	BA2196		23914 16,3 /WE/S	LUC
	1.6 i 16V 1.8 TFSI 1.8 TSI 1.8 TSI 2.0 TDI 2.0 TDI 2.0 TFSI	75 110 88 118 88 105 125	04.09 04.09 09.10 05.10 04.09 04.09 04.09	PR: 1KD PR: 1KD PR: 1KD PR: 1KD PR: 1KD PR: 1KD PR: 1KD	BAR10261		245 10,0 8,0	

**SEAT IBIZA I (85-92)**

	0.9 1.2 1.5 1.5 i 1.7 D 1.7 i		11.86 01.93 05.85 01.93 05.85 01.93 04.88 01.93 05.85 01.93 01.92 01.93		BA2064 BA2065		20775 18,0 /WE 20775 18,0 /WK	BDX BDX
--	--	--	--	--	------------------	--	----------------------------------	------------

**SEAT IBIZA II (93-99)**

	1.0 i 1.3 i 1.4 i		02.93 12.96 - ABS 02.93 12.96 - ABS 09.93 12.96 - ABS		BA2131		20889 17,3 /Zub	VW
	1.0 i 1.3 i 1.4 i 1.6 i 1.8 i 1.9 D		02.93 12.96 + ABS 02.93 12.96 + ABS 09.93 12.96 + ABS 02.93 12.96 6K-ZR003620 02.93 6K-ZR003611 02.93		BA2132		20887 19,7 +/Zub	VW

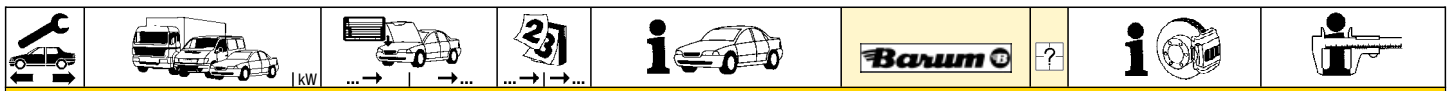















**SEAT IBIZA II (93-99)**

	1.9 TD		6K-ZR003513	<b>02.93</b>			BA2132		20887 19,7 +/Zub	VW
	1.8 i		6K-ZR003621			12.96	BA2153		21866 15,3 +	VW
	1.9 D		6K-ZR003612			12.96	BA2133		20887 15,3 +/Zub	VW
	1.9 TD		6K-ZR003514			12.96				
	1.6 i			02.93	12.96		BA2037		20168 16,3 /S	LUC
	1.8 i			02.93	12.96					
	1.8 i 16V			02.94	12.96					
	2.0 i			02.93	12.96					
	2.0 i 16V Cupra 2			07.96	12.96					
	1.0 i			01.97	07.99	PR: 1LA	BA2141		20887 17,3 +/Zub	VW
1.3 i			01.97	07.99	PR: 1LA					
1.4 i			01.97	07.99	PR: 1LA					
1.4 i 16V	74		01.97	07.99	PR: 1LA					
1.6 i			01.97	07.99	PR: 1LA					
1.7 SDI			07.97	07.99	PR: 1LA					
1.8 i			01.97	07.99	PR: 1LA					
1.8 i 16V			01.97	07.99	PR: 1LA					
1.9 D			01.97	07.99	PR: 1LA					
1.9 SDI			09.95	07.99	PR: 1LA					
1.9 TD			01.97	07.99	PR: 1LA					
1.9 TDI	66		07.96	07.99	PR: 1LA					
1.9 TDI	81		03.97	07.99	PR: 1LA					
2.0 i			01.97	07.99	PR: 1LA					
2.0 i 16V Cupra 2			01.97	07.99	PR: 1LA					
1.0 i			01.97	07.99	PR: 1LG	BA2153		21866 15,3 +	VW	
1.3 i			01.97	07.99	PR: 1LG					
1.4 i			01.97	07.99	PR: 1LG					
1.4 i 16V	74		01.97	07.99	PR: 1LG					
1.6 i			01.97	07.99	PR: 1LG					
1.7 SDI			07.97	07.99	PR: 1LG					
1.8 i			01.97	07.99	PR: 1LG					
1.8 i 16V			01.97	07.99	PR: 1LG					
1.9 D			01.97	07.99	PR: 1LG					
1.9 SDI			09.95	07.99	PR: 1LG					
1.9 TD			01.97	07.99	PR: 1LG					
1.9 TDI	66		07.96	07.99	PR: 1LG					
1.9 TDI	81		03.97	07.99	PR: 1LG					
2.0 i			01.97	07.99	PR: 1LG					
2.0 i 16V Cupra 2			01.97	07.99	PR: 1LG					
1.0 i			01.97	07.99	PR: 1LM	BA2145		21866 19,7 +	VW	
1.3 i			01.97	07.99	PR: 1LM					
1.4 i			01.97	07.99	PR: 1LM					
1.4 i 16V	74		01.97	07.99	PR: 1LM					
1.6 i			01.97	07.99	PR: 1LM					
1.7 SDI			07.97	07.99	PR: 1LM					
1.8 i			01.97	07.99	PR: 1LM					
1.8 i 16V			01.97	07.99	PR: 1LM					
1.9 D			01.97	07.99	PR: 1LM					
1.9 SDI			09.95	07.99	PR: 1LM					
1.9 TD			01.97	07.99	PR: 1LM					
1.9 TDI	66		07.96	07.99	PR: 1LM					
1.9 TDI	81		03.97	07.99	PR: 1LM					
2.0 i			01.97	07.99	PR: 1LM					
2.0 i 16V Cupra 2			01.97	07.99	PR: 1LM					
1.0 i			01.97	07.99	PR: 1LY,1ZK	BA2018		21945 16,3 /S	LUC	
1.3 i			01.97	07.99	PR: 1LY,1ZK					
1.4 i			01.97	07.99	PR: 1LY,1ZK					
1.4 i 16V	74		01.97	07.99	PR: 1LY,1ZK					
1.6 i			01.97	07.99	PR: 1LY,1ZK					
1.7 SDI			07.97	07.99	PR: 1LY,1ZK					
1.8 i			01.97	07.99	PR: 1LY,1ZK					
1.8 i 16V			01.97	07.99	PR: 1LY,1ZK					
1.9 D			01.97	07.99	PR: 1LY,1ZK					
1.9 SDI			09.95	07.99	PR: 1LY,1ZK					
1.9 TD			01.97	07.99	PR: 1LY,1ZK					
1.9 TDI	66		07.96	07.99	PR: 1LY,1ZK					
1.9 TDI	81		03.97	07.99	PR: 1LY,1ZK					
2.0 i			01.97	07.99	PR: 1LY,1ZK					
2.0 i 16V Cupra 2			01.97	07.99	PR: 1LY,1ZK					
1.0 i			01.97	07.99	PR: 1LD,1LV,1LW	BA2038		20168 19,6 /S	LUC	
1.3 i			01.97	07.99	PR: 1LD,1LV,1LW					
1.4 i			01.97	07.99	PR: 1LD,1LV,1LW					
1.4 i 16V	74		01.97	07.99	PR: 1LD,1LV,1LW					
1.6 i			01.97	07.99	PR: 1LD,1LV,1LW					
1.7 SDI			07.97	07.99	PR: 1LD,1LV,1LW					
1.8 i			01.97	07.99	PR: 1LD,1LV,1LW					
1.8 i 16V			01.97	07.99	PR: 1LD,1LV,1LW					
1.9 D			01.97	07.99	PR: 1LD,1LV,1LW					
1.9 SDI			09.95	07.99	PR: 1LD,1LV,1LW					
1.9 TD			01.97	07.99	PR: 1LD,1LV,1LW					
1.9 TDI	66		07.96	07.99	PR: 1LD,1LV,1LW					
1.9 TDI	81		03.97	07.99	PR: 1LD,1LV,1LW					
2.0 i			01.97	07.99	PR: 1LD,1LV,1LW					
2.0 i 16V Cupra 2			01.97	07.99	PR: 1LD,1LV,1LW					

































**SEAT IBIZA II (93-99)**

	1.0 i		02.93	07.99	PR: 1LA	BAR10151		239 9,9 8,0
	1.3 i		02.93	07.99	PR: 1LA			
	1.4 i		09.93	07.99	PR: 1LA			
	1.4 i 16V	74	09.96	07.99	PR: 1LA			
	1.6 i		02.93	07.99	PR: 1LA			
1.7 SDI		07.97	07.99	PR: 1LA				
1.8 i		02.93	07.99	PR: 1LA				
1.8 i 16V		02.94	07.99	PR: 1LA				
1.9 D		02.93	07.99	PR: 1LA				
1.9 SDI		09.95	07.99	PR: 1LA				
1.9 TD		02.93	07.99	PR: 1LA				
1.9 TDI	66	07.96	07.99	PR: 1LA				
1.9 TDI	81	03.97	07.99	PR: 1LA				
2.0 i		02.93	07.99	PR: 1LA				
2.0 i 16V Cupra 2		07.96	07.99	PR: 1LA				
	1.0 i		02.93	07.99	PR: 1LG	BAR20123		239 20,0 18,0 V L
	1.3 i		02.93	07.99	PR: 1LG			
	1.4 i		09.93	07.99	PR: 1LG			
	1.4 i 16V	74	09.96	07.99	PR: 1LG			
	1.6 i		02.93	07.99	PR: 1LG			
1.7 SDI		07.97	07.99	PR: 1LG				
1.8 i		02.93	07.99	PR: 1LG				
1.8 i 16V		02.94	07.99	PR: 1LG				
1.9 D		02.93	07.99	PR: 1LG				
1.9 SDI		09.95	07.99	PR: 1LG				
1.9 TD		02.93	07.99	PR: 1LG				
1.9 TDI	66	07.96	07.99	PR: 1LG				
1.9 TDI	81	03.97	07.99	PR: 1LG				
2.0 i		02.93	07.99	PR: 1LG				
2.0 i 16V Cupra 2		07.96	07.99	PR: 1LG				
	1.0 i		01.97	07.99	PR: 1LM	BAR20123		239 20,0 18,0 V L
	1.3 i		01.97	07.99	PR: 1LM			
	1.4 i		01.97	07.99	PR: 1LM			
	1.4 i 16V	74	01.97	07.99	PR: 1LM			
	1.6 i		01.97	07.99	PR: 1LM			
1.7 SDI		07.97	07.99	PR: 1LM				
1.8 i		01.97	07.99	PR: 1LM				
1.8 i 16V		01.97	07.99	PR: 1LM				
1.9 D		01.97	07.99	PR: 1LM				
1.9 SDI		09.95	07.99	PR: 1LM				
1.9 TD		01.97	07.99	PR: 1LM				
1.9 TDI	66	07.96	07.99	PR: 1LM				
1.9 TDI	81	03.97	07.99	PR: 1LM				
2.0 i		01.97	07.99	PR: 1LM				
2.0 i 16V Cupra 2		01.97	07.99	PR: 1LM				
	1.0 i		01.97	07.99	PR: 1LY,1ZK	BAR20128		256 20,0 18,0 V L
	1.3 i		01.97	07.99	PR: 1LY,1ZK			
	1.4 i		01.97	07.99	PR: 1LY,1ZK			
	1.4 i 16V	74	01.97	07.99	PR: 1LY,1ZK			
	1.6 i		01.97	07.99	PR: 1LY,1ZK			
1.7 SDI		07.97	07.99	PR: 1LY,1ZK				
1.8 i		01.97	07.99	PR: 1LY,1ZK				
1.8 i 16V		01.97	07.99	PR: 1LY,1ZK				
1.9 D		01.97	07.99	PR: 1LY,1ZK				
1.9 SDI		09.95	07.99	PR: 1LY,1ZK				
1.9 TD		01.97	07.99	PR: 1LY,1ZK				
1.9 TDI	66	07.96	07.99	PR: 1LY,1ZK				
1.9 TDI	81	03.97	07.99	PR: 1LY,1ZK				
2.0 i		01.97	07.99	PR: 1LY,1ZK				
2.0 i 16V Cupra 2		01.97	07.99	PR: 1LY,1ZK				
	1.0 i		02.93	07.99		BAH0005	2	L=435
	1.3 i		02.93	07.99				
	1.4 i		09.93	07.99				
	1.4 i 16V	74	09.96	07.99				
	1.6 i		02.93	07.99				
1.7 SDI		07.97	07.99					
1.8 i		02.93	07.99					
1.8 i 16V		02.94	07.99					
1.9 D		02.93	07.99					
1.9 SDI		09.95	07.99					
1.9 TD		02.93	07.99					
1.9 TDI	66	07.96	07.99					
1.9 TDI	81	03.97	07.99					
2.0 i		02.93	07.99					
2.0 i 16V Cupra 2		07.96	07.99					
	1.8 i 16V	81	02.94	07.99		BA2032		20961 15,2 /S LUC
	1.9 TDI		03.97	07.99				
	2.0 i		02.93	07.99		BA2017		20961 17,2 /S LUC
	2.0 i 16V Cupra 2		07.96	07.99				
	1.0 i		02.93	07.99	PR: 1KK	BA2017		20961 17,2 /S LUC
	1.3 i		02.93	07.99	PR: 1KK			
	1.4 i		09.93	07.99	PR: 1KK			
1.4 i 16V	74	09.96	07.99	PR: 1KK				
1.6 i		02.93	07.99	PR: 1KK				
1.7 SDI		07.97	07.99	PR: 1KK				
1.8 i		02.93	07.99	PR: 1KK				

									
<b>SEAT IBIZA II (93-99)</b>									
	1.8 i 16V 1.9 D 1.9 SDI 1.9 TD 1.9 TDI 1.9 TDI 2.0 i 2.0 i 16V Cupra 2			02.94 07.99 PR: 1KK 02.93 07.99 PR: 1KK 09.95 07.99 PR: 1KK 02.93 07.99 PR: 1KK 07.96 07.99 PR: 1KK 03.97 07.99 PR: 1KK 02.93 07.99 PR: 1KK 07.96 07.99 PR: 1KK		BA2017			20961 17,2 /S LUC
	1.8 i 16V 1.9 TDI 2.0 i	81		02.94 07.99 03.97 07.99 02.93 07.99		BAR10111	ohne Sensorring <sup>1)</sup>	226 10,0 8,0	
	1.0 i 1.3 i 1.4 i 1.4 i 16V 1.6 i 1.7 SDI 1.8 i 1.8 i 16V 1.9 D 1.9 SDI 1.9 TD 1.9 TDI 1.9 TDI 2.0 i 2.0 i 16V Cupra 2	74	66 81	02.93 07.99 PR: 1KK 02.93 07.99 PR: 1KK 09.93 07.99 PR: 1KK 09.96 07.99 PR: 1KK 02.93 07.99 PR: 1KK 07.97 07.99 PR: 1KK 02.93 07.99 PR: 1KK 02.94 07.99 PR: 1KK 02.93 07.99 PR: 1KK 07.96 07.99 PR: 1KK 03.97 07.99 PR: 1KK 02.93 07.99 PR: 1KK 07.96 07.99 PR: 1KK		BAR09124		232 8,9 7,0	
	1.0 i 1.3 i 1.4 i 1.4 i 16V 1.6 i 1.7 SDI 1.8 i 1.9 D 1.9 SDI 1.9 TD 1.9 TDI	74		02.93 07.99 02.93 07.99 09.93 07.99 09.96 07.99 02.93 07.99 07.97 07.99 02.93 07.99 02.93 07.99 09.95 07.99 02.93 07.99 07.96 07.99		BAH0016	2	L=135	
	1.8 i 16V 1.9 TDI 2.0 i 2.0 i 16V Cupra 2	81		02.94 07.99 03.97 07.99 02.93 07.99 07.96 07.99		BAH0003	2	L=160	
	1.0 i 1.3 i 1.4 i 1.4 i 16V 1.6 i 1.7 SDI 1.8 i 1.8 i 16V 1.9 D 1.9 SDI 1.9 TD 1.9 TDI	74	66	02.93 07.99 02.93 07.99 09.93 07.99 09.96 07.99 02.93 07.99 07.97 07.99 02.93 07.99 02.94 07.99 02.93 07.99 09.95 07.99 02.93 07.99 07.96 07.99		BAW1701 BAW1905	- ABS + ABS	Rz 17,46 Rz 19,05	
	1.0 i 1.3 i 1.4 i 1.4 i 16V 1.6 i	74		02.93 07.99 - ABS 02.93 07.99 - ABS 09.93 07.99 - ABS 09.96 07.99 - ABS 02.93 07.99 - ABS		BAE5003		180 x 31 HEB	
	1.0 i 1.3 i 1.4 i 1.4 i 16V 1.6 i 1.7 SDI 1.8 i 1.9 D 1.9 SDI 1.9 TD 1.9 TDI	74	66	02.93 07.99 + ABS 02.93 07.99 + ABS 09.93 07.99 + ABS 09.96 07.99 + ABS 02.93 07.99 + ABS 07.97 07.99 02.93 07.99 02.93 07.99 09.95 07.99 02.93 07.99 07.96 07.99		BAE5001		200 x 40 HEB VW	
<b>SEAT IBIZA III (6K1) (99-02)</b>									
	1.0 i 1.4 i 1.4 i 16V 1.6 i 1.8 T 20V 1.9 SDI 1.9 TDI 1.9 TDI	44	115 66 81	08.99 01.02 PR: 1LG 08.99 01.02 PR: 1LG 08.99 01.02 PR: 1LG 08.99 01.02 PR: 1LG 07.00 01.02 PR: 1LG 08.99 01.02 PR: 1LG 08.99 01.02 PR: 1LG 08.99 01.02 PR: 1LG		BA2153		21866 15,3 + VW	
	1.0 i 1.4 i 1.4 i 16V 1.6 i 1.8 T 20V 1.9 SDI 1.9 TDI	44	115 66	08.99 01.02 PR: 12K 08.99 01.02 PR: 1LM,12K 08.99 01.02 PR: 12K 08.99 01.02 PR: 12K 07.00 01.02 PR: 12K 08.99 01.02 PR: 1LM,12K 08.99 01.02 PR: 12K		BA2018		21945 16,3 /S LUC	

<sup>1)</sup> without sensor ring / senza sensori / sans secours ABS / sin anillo sensor ABS

	   kW								
<b>SEAT IBIZA III (6K1) (99-02)</b>									
	1.9 TDI	81		08.99 01.02 PR: 12K	BA2018			21945 16,3 /S LUC	
	1.0 i			08.99 01.02 PR: 1LV,1LW	BA2038			20168 19,6 /S LUC	
	1.4 i	44		08.99 01.02 PR: 1LV,1LW					
	1.4 i 16V			08.99 01.02 PR: 1LV,1LW					
	1.6 i			08.99 01.02 PR: 1LV,1LW					
	1.8 T 20V	115		07.00 01.02 PR: 1LV,1LW					
	1.9 SDI			08.99 01.02 PR: 1LV,1LW					
	1.9 TDI	66		08.99 01.02 PR: 1LV,1LW					
	1.9 TDI	81		08.99 01.02 PR: 1LV,1LW					
	1.0 i		6K-W-000 500	08.99	PR: 1LA	BA2141		- ABS	20887 17,3 +/Zub VW
1.4 i	44		08.99	PR: 1LA					
1.4 i 16V		6K-W-000 500	08.99	PR: 1LA					
1.6 i		6K-W-000 500	08.99	PR: 1LA					
1.8 T 20V	115		07.00	PR: 1LA					
1.9 SDI		6K-W-000 500	08.99	PR: 1LA					
1.9 TDI	66		08.99	PR: 1LA					
1.9 TDI	81		08.99	PR: 1LA					
	1.4 i	44		08.99 01.02 PR: 1LM	BAR12106			239 12,0 10,0	
	1.9 SDI			08.99 01.02 PR: 1LM					
	1.0 i			08.99 01.02 PR: 1LG	BAR20123			239 20,0 18,0 V L	
	1.4 i	44		08.99 01.02 PR: 1LG					
	1.4 i 16V			08.99 01.02 PR: 1LG					
	1.6 i			08.99 01.02 PR: 1LG					
	1.8 T 20V	115		07.00 01.02 PR: 1LG					
	1.9 SDI			08.99 01.02 PR: 1LG					
	1.9 TDI	66		08.99 01.02 PR: 1LG					
	1.9 TDI	81		08.99 01.02 PR: 1LG					
	1.0 i			08.99 01.02 PR: 12K	BAR20128			256 20,0 18,0 V L	
	1.4 i	44		08.99 01.02 PR: 12K					
	1.4 i 16V			08.99 01.02 PR: 12K					
	1.6 i			08.99 01.02 PR: 12K					
	1.8 T 20V	115		07.00 01.02 PR: 12K					
	1.9 SDI			08.99 01.02 PR: 12K					
	1.9 TDI	66		08.99 01.02 PR: 12K					
	1.9 TDI	81		08.99 01.02 PR: 12K					
	1.0 i		6K-W-000 500	08.99	PR: 1LA	BAR10151		- ABS	239 9,9 8,0
	1.4 i	44		08.99	PR: 1LA				
1.4 i 16V		6K-W-000 500	08.99	PR: 1LA					
1.6 i		6K-W-000 500	08.99	PR: 1LA					
1.8 T 20V	115		07.00	PR: 1LA					
1.9 SDI		6K-W-000 500	08.99	PR: 1LA					
1.9 TDI	66		08.99	PR: 1LA					
1.9 TDI	81		08.99	PR: 1LA					
	1.0 i			08.99 01.02	BAH0005	2		L=435	
	1.4 i	44		08.99 01.02					
	1.4 i 16V			08.99 01.02					
	1.6 i			08.99 01.02					
	1.8 T 20V	115		07.00 01.02					
	1.9 SDI			08.99 01.02					
1.9 TDI	66		08.99 01.02						
1.9 TDI	81		08.99 01.02						
	1.0 i			08.99 01.02 PR: 1KE,1KK,1KQ	BA2017			20961 17,2 /S LUC	
	1.4 i	44		08.99 01.02 PR: 1KE,1KK,1KQ					
	1.4 i 16V			08.99 01.02 PR: 1KE,1KK,1KQ					
	1.6 i			08.99 01.02 PR: 1KE,1KK,1KQ					
	1.8 i Cupra R	132		04.01 01.02 PR: 1KE,1KK,1KQ					
	1.8 T 20V	115		07.00 01.02 PR: 1KE,1KK,1KQ					
	1.9 SDI			08.99 01.02 PR: 1KE,1KK,1KQ					
	1.9 TDI	66		08.99 01.02 PR: 1KE,1KK,1KQ					
1.9 TDI	81		08.99 01.02 PR: 1KE,1KK,1KQ						
	1.0 i			08.99 01.02 PR: 1KE,1KK,1KQ	BAR09124			232 8,9 7,0	
	1.4 i	44		08.99 01.02 PR: 1KE,1KK,1KQ					
	1.4 i 16V			08.99 01.02 PR: 1KE,1KK,1KQ					
	1.6 i			08.99 01.02 PR: 1KE,1KK,1KQ					
	1.8 i Cupra R	132		04.01 01.02 PR: 1KE,1KK,1KQ					
	1.8 T 20V	115		07.00 01.02 PR: 1KE,1KK,1KQ					
	1.9 SDI			08.99 01.02 PR: 1KE,1KK,1KQ					
	1.9 TDI	66		08.99 01.02 PR: 1KE,1KK,1KQ					
1.9 TDI	81		08.99 01.02 PR: 1KE,1KK,1KQ						
	1.0 i			08.99 01.02	BAH0033	2		L=140	
	1.4 i	44		08.99 01.02					
	1.4 i 16V			08.99 01.02					
	1.6 i			08.99 01.02					
	1.8 i Cupra R	132		04.01 01.02					
	1.8 T 20V	115		07.00 01.02					
1.9 SDI			08.99 01.02						
1.9 TDI	66		08.99 01.02						
1.9 TDI	81		08.99 01.02						
	1.0 i			08.99 01.02	BAW1701			Rz 17,46	
	1.4 i	44		08.99 01.02					
	1.4 i 16V	55		08.99 01.02					
	1.6 i	55		08.99 01.02					
	1.9 SDI			08.99 01.02					
1.9 TDI	66		08.99 01.02						
↓	1.4 i 16V	74		08.99 01.02	BAW1905			Rz 19,05	

								
<b>SEAT IBIZA III (6K1) (99-02)</b>								
	1.6 i	74		08.99	01.02		BAW1905	Rz 19,05
	1.0 i			08.99	01.02		BAE5001	200 x 40 HEB
	1.4 i	44		08.99	01.02			VW
	1.4 i 16V			08.99	01.02			
	1.6 i			08.99	01.02			
	1.9 SDI			08.99	01.02			
	1.9 TDI	66		08.99	01.02			
<b>SEAT IBIZA IV (6L1) (02-10)</b>								
	1.2	44		06.07	05.08	PR: 1LQ,1ZF	BA2154	23130 19,6 +
	1.2 i	47		02.02	02.10	PR: 1LQ,1ZF		VW
	1.2 i 12V	51		05.06	02.10	PR: 1LQ,1ZF		
	1.4 i 16V	55		02.02	02.10	PR: 1LQ,1ZF		
	1.4 i 16V	63		05.06	02.10	PR: 1LQ,1ZF		
	1.4 i 16V	74		02.02	02.10	PR: 1LQ,1ZF		
	1.4 TDI	51		05.05	02.10	PR: 1LQ,1ZF		
	1.4 TDI	55		02.02	02.10	PR: 1LQ,1ZF		
	1.4 TDI	59		05.05	02.10	PR: 1LQ,1ZF		
	1.6 i 16V			02.03	02.10	PR: 1LQ,1ZF		
	1.8 T FR	110		12.03	02.10	PR: 1LQ,1ZF		
	1.9 SDI	47		02.02	02.10	PR: 1LQ,1ZF		
	1.9 TDI	74		02.02	02.10	PR: 1LQ,1ZF		
	1.9 TDI	96		02.02	02.10	PR: 1LQ,1ZF		
	1.9 TDI Cupra R	110		01.04	02.10	PR: 1LQ,1ZF		
	1.9 TDI Cupra R	118		03.04	02.08	PR: 1LQ,1ZF		
	2.0	85		04.02	02.10	PR: 1LQ,1ZF		
	1.2	44		06.07	05.08	PR: 1LN,1ZH	BA2298	23843 18,8 +/WK/S
	1.2 i	47		02.02	02.10	PR: 1LN,1ZH		LUC
	1.2 i 12V	51		05.06	02.10	PR: 1LN,1ZH		
	1.4 i 16V	55		02.02	02.10	PR: 1LN,1ZH		
	1.4 i 16V	63		05.06	02.10	PR: 1LN,1ZH		
	1.4 i 16V	74		02.02	02.10	PR: 1LN,1ZH		
	1.4 TDI	51		05.05	02.10	PR: 1LN,1ZH		
	1.4 TDI	55		02.02	02.10	PR: 1LN,1ZH		
	1.4 TDI	59		05.05	02.10	PR: 1LN,1ZH		
	1.6 i 16V			02.03	02.10	PR: 1LN,1ZH		
	1.8 T FR	110		12.03	02.10	PR: 1LN,1ZH		
	1.9 SDI	47		02.02	02.10	PR: 1LN,1ZH		
	1.9 TDI	74		02.02	02.10	PR: 1LN,1ZH		
	1.9 TDI	96		02.02	02.10	PR: 1LN,1ZH		
	1.9 TDI Cupra R	110		01.04	02.10	PR: 1LN,1ZH		
	1.9 TDI Cupra R	118		03.04	02.08	PR: 1LN,1ZH		
	2.0	85		04.02	02.10	PR: 1LN,1ZH		
	1.8 T Cupra R	132		01.04	02.10		BA2333	21911 20,3 +
	1.2	44		06.07	05.08	PR: 1LQ,1ZF	BAR22151	256 22,0 19,0 V L
	1.2 i	47		02.02	02.10	PR: 1LQ,1ZF		
	1.2 i 12V	51		05.06	02.10	PR: 1LQ,1ZF		
	1.4 i 16V	55		02.02	02.10	PR: 1LQ,1ZF		
	1.4 i 16V	63		05.06	02.10	PR: 1LQ,1ZF		
	1.4 i 16V	74		02.02	02.10	PR: 1LQ,1ZF		
	1.4 TDI	51		05.05	02.10	PR: 1LQ,1ZF		
	1.4 TDI	55		02.02	02.10	PR: 1LQ,1ZF		
	1.4 TDI	59		05.05	02.10	PR: 1LQ,1ZF		
	1.6 i 16V			02.03	02.10	PR: 1LQ,1ZF		
	1.8 T FR	110		12.03	02.10	PR: 1LQ,1ZF		
	1.9 SDI	47		02.02	02.10	PR: 1LQ,1ZF		
	1.9 TDI	74		02.02	02.10	PR: 1LQ,1ZF		
	1.9 TDI	96		02.02	02.10	PR: 1LQ,1ZF		
	1.9 TDI Cupra R	110		01.04	02.10	PR: 1LQ,1ZF		
	1.9 TDI Cupra R	118		03.04	02.08	PR: 1LQ,1ZF		
	2.0	85		04.02	02.10	PR: 1LQ,1ZF		
	1.2	44		06.07	05.08	PR: 1LN,1ZH	BAR25113	288 25,0 22,0 V L
	1.2 i	47		02.02	02.10	PR: 1LN,1ZH		
	1.2 i 12V	51		05.06	02.10	PR: 1LN,1ZH		
	1.4 i 16V	55		02.02	02.10	PR: 1LN,1ZH		
	1.4 i 16V	63		05.06	02.10	PR: 1LN,1ZH		
	1.4 i 16V	74		02.02	02.10	PR: 1LN,1ZH		
	1.4 TDI	51		05.05	02.10	PR: 1LN,1ZH		
	1.4 TDI	55		02.02	02.10	PR: 1LN,1ZH		
	1.4 TDI	59		05.05	02.10	PR: 1LN,1ZH		
	1.6 i 16V			02.03	02.10	PR: 1LN,1ZH		
	1.8 T FR	110		12.03	02.10	PR: 1LN,1ZH		
	1.9 SDI	47		02.02	02.10	PR: 1LN,1ZH		
	1.9 TDI	74		02.02	02.10	PR: 1LN,1ZH		
	1.9 TDI	96		02.02	02.10	PR: 1LN,1ZH		
	1.9 TDI Cupra R	110		01.04	02.10	PR: 1LN,1ZH		
	1.9 TDI Cupra R	118		03.04	02.08	PR: 1LN,1ZH		
	2.0	85		04.02	02.10	PR: 1LN,1ZH		
	1.8 T Cupra R	132		01.04	02.10		BAR25123	312 25,0 23,0 V L
	1.2	44		06.07	05.08		BA2017	20961 17,2 /S
	1.2 i	47		02.02	02.10			LUC
	1.2 i 12V	51		05.06	02.10			
	1.4 i 16V	55		02.02	02.10			
	1.4 i 16V	63		05.06	02.10			

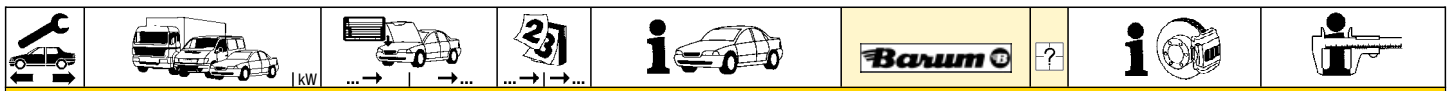

**SEAT IBIZA IV (6L1) (02-10)**

	1.4 i 16V 1.4 TDI 1.4 TDI 1.4 TDI 1.6 i 16V 1.8 T Cupra R 1.8 T FR 1.9 SDI 1.9 TDI 1.9 TDI 1.9 TDI Cupra R 1.9 TDI Cupra R 2.0	74 51 55 59 132 110 47 74 96 110 118 85		02.02 05.05 02.02 05.05 02.03 01.04 12.03 02.02 02.02 02.02 01.04 03.04 04.02	02.10 02.10 02.10 02.10 02.10 02.10 02.10 02.10 02.10 02.10 02.10 02.08 02.10	BA2017		20961 17,2 /S	LUC
	1.2 1.2 i 1.2 i 12V 1.4 i 16V 1.4 i 16V 1.4 i 16V 1.4 TDI 1.4 TDI 1.4 TDI 1.6 i 16V 1.8 T Cupra R 1.8 T FR 1.9 SDI 1.9 TDI 1.9 TDI 1.9 TDI Cupra R 1.9 TDI Cupra R 2.0	44 47 51 55 63 74 51 55 59 132 110 47 74 96 110 118 85		06.07 02.02 05.06 02.02 05.06 02.02 05.05 02.02 05.05 02.03 01.04 12.03 02.02 02.02 01.04 03.04 04.02	05.08 02.10 02.10 02.10 02.10 02.10 02.10 02.10 02.10 02.10 02.10 02.10 02.10 02.10 02.10 02.10 02.08 02.10	BAR09123		232 8,9 7,0	
	1.2 1.2 i 1.2 i 12V 1.4 i 16V 1.4 i 16V 1.4 i 16V 1.4 TDI 1.4 TDI 1.4 TDI 1.6 i 16V 1.8 T Cupra R 1.8 T FR 1.9 SDI 1.9 TDI 1.9 TDI 1.9 TDI Cupra R 1.9 TDI Cupra R 2.0	44 47 51 55 63 74 51 55 59 132 110 47 74 96 110 118 85		06.07 02.02 05.06 02.02 05.06 02.02 05.05 02.02 05.05 02.03 01.04 12.03 02.02 02.02 01.04 03.04 04.02	05.08 PR: 1KD,1KK,1KS,1KT,1KP 02.10 PR: 1KD,1KK,1KS,1KT,1KP 02.10 PR: 1KD,1KK,1KS,1KT,1KP 02.10 PR: 1KD,1KK,1KS,1KT,1KP 02.10 PR: 1KD,1KK,1KS,1KT,1KP 02.10 PR: 1KD,1KK,1KS,1KT,1KP 02.10 PR: 1KD,1KK,1KS,1KT,1KP 02.10 PR: 1KD,1KK,1KS,1KT,1KP 02.10 PR: 1KD,1KK,1KS,1KT,1KP 02.10 PR: 1KD,1KK,1KS,1KT,1KP 02.10 PR: 1KD,1KK,1KS,1KT,1KP 02.10 PR: 1KD,1KK,1KS,1KT,1KP 02.10 PR: 1KD,1KK,1KS,1KT,1KP 02.10 PR: 1KD,1KK,1KS,1KT,1KP 02.10 PR: 1KD,1KK,1KS,1KT,1KP 02.10 PR: 1KD,1KK,1KS,1KT,1KP 02.10 PR: 1KD,1KK,1KS,1KT,1KP	BAH0033	2	L=140	
	1.2 1.2 i 1.2 i 12V 1.4 i 16V 1.4 i 16V 1.4 i 16V 1.4 TDI 1.4 TDI 1.4 TDI 1.6 i 16V 1.9 SDI 1.9 TDI 1.9 TDI 1.9 TDI Cupra R 1.9 TDI Cupra R 2.0	44 47 51 55 63 74 51 55 59 132 110 47 74 96 110 118 85		06.07 02.02 05.06 02.02 05.06 02.02 05.05 02.02 05.05 02.03 02.02 02.02 02.02 01.04 03.04 04.02	05.08 02.10 02.10 02.10 02.10 02.10 02.10 02.10 02.10 02.10 02.10 02.10 02.10 02.10 02.10 02.08 02.10	BAW1905		Rz 19,05	
	1.2 1.2 i 1.2 i 12V 1.4 i 16V 1.4 i 16V 1.4 i 16V 1.4 TDI 1.4 TDI 1.4 TDI 1.6 i 16V 1.9 SDI 1.9 TDI 1.9 TDI 1.9 TDI Cupra R 1.9 TDI Cupra R 2.0	44 47 51 55 63 74 51 55 59 132 110 47 74 96 110 118 85	6L-7-108 000 6L-7-108 000 6L-7-108 000 6L-7-108 000 6L-7-108 000 6L-7-108 000 6L-7-108 000 6L-7-108 000 6L-7-108 000 6L-7-108 000 6L-7-108 000 6L-7-108 000 6L-7-108 000 6L-7-108 000 6L-7-108 000 6L-7-108 000	06.07 02.02 05.06 02.02 05.06 02.02 05.05 02.02 05.05 02.03 02.02 02.02 02.02 01.04 03.04 04.02	05.08 02.10 02.10 02.10 02.10 02.10 02.10 02.10 02.10 02.10 02.10 02.10 02.10 02.10 02.10 02.10	BAE5001		200 x 40 HEB	VW
	1.2 1.2 i 1.2 i 12V 1.4 i 16V 1.4 i 16V 1.4 i 16V	44 47 51 55 63 74	6L-7-108 001 6L-7-108 001 6L-7-108 001 6L-7-108 001 6L-7-108 001 6L-7-108 001		05.08 02.10 02.10 02.10 02.10 02.10	BAE5001		200 x 40 HEB	VW

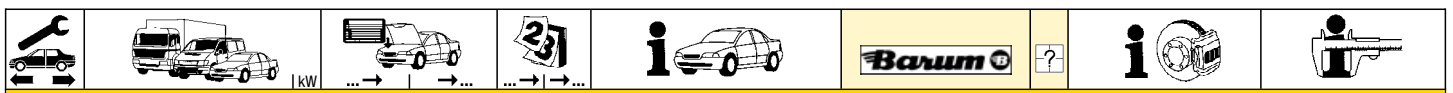

**SEAT IBIZA IV (6L1) (02-10)**

	1.4 TDI	51	6L-7-108 001			<b>02.10</b>		<b>BAE5001</b>		200 x 40 HEB	<b>VW</b>
	1.4 TDI	55	6L-7-108 001			<b>02.10</b>					
	1.4 TDI	59	6L-7-108 001			<b>02.10</b>					
	1.6 i 16V		6L-7-108 001			<b>02.10</b>					
	1.9 SDI	47	6L-7-108 001			<b>02.10</b>					
	1.9 TDI	74	6L-7-108 001			<b>02.10</b>					
	1.9 TDI	96	6L-7-108 001			<b>02.10</b>					
	1.9 TDI Cupra R	110	6L-7-108 001			<b>02.10</b>					
	1.9 TDI Cupra R	118	6L-7-108 001			<b>02.08</b>					
	2.0	85	6L-7-108 001			<b>02.10</b>					

**SEAT IBIZA V / ST / SPORTCOUPE (08-)**

	1.2	44			<b>07.09</b>	PR: 1LQ,1LR,1ZG		<b>BA2154</b>		+ 14" Rad <sup>1)</sup>	<b>23130</b> 19,6 +	<b>VW</b>
	1.2	51			<b>07.08</b>	PR: 1LQ,1LR,1ZG		<b>BA2155</b>		+ 14" Rad <sup>1)</sup>	<b>23131</b> 19,6 +/WK	<b>VW</b>
	1.2 TDI	55			<b>04.10</b>	PR: 1LQ,1LR,1ZG						
	1.2 TSI	77			<b>09.10</b>	PR: 1LQ,1LR,1ZG						
	1.4 i 16V	63			<b>07.08</b>	PR: 1LQ,1LR,1ZG						
	1.4 TDI	59			<b>07.08</b>	PR: 1LQ,1LR,1ZG						
	1.4 TSI FR	110			<b>06.09</b>	PR: 1LQ,1LR,1ZG						
	1.6 i 16V	77			<b>07.08</b>	PR: 1LQ,1LR,1ZG						
	1.6 LPG	60			<b>05.11</b>	PR: 1LQ,1LR,1ZG						
	1.6 TDI	66			<b>06.09</b>	PR: 1LQ,1LR,1ZG						
	1.6 TDI	77			<b>06.09</b>	PR: 1LQ,1LR,1ZG						
	1.9 TDI	66			<b>07.08</b>	PR: 1LQ,1LR,1ZG						
	1.9 TDI	77			<b>07.08</b>	PR: 1LQ,1LR,1ZG						
	2.0	85			<b>10.08</b>	PR: 1LQ,1LR,1ZG						
	2.0 TDI	105			<b>01.10</b>	PR: 1LQ,1LR,1ZG						

	1.2	44	6J-9-000 001					<b>BA2195</b>		+ 15" Rad <sup>2)</sup>	<b>23587</b> 19,6 +/WK	<b>ATE</b>
	1.2	51	6J-9-000 001									
	1.2 TDI	55	6J-9-000 001									
	1.2 TSI	77	6J-9-000 001									
	1.4 i 16V	63	6J-9-000 001									
	1.4 TDI	59	6J-9-000 001									
	1.4 TSI FR	110	6J-9-000 001									
	1.6 i 16V	77	6J-9-000 001									
	1.6 LPG	60	6J-9-000 001									
	1.6 TDI	66	6J-9-000 001									
	1.6 TDI	77	6J-9-000 001									
	1.9 TDI	66	6J-9-000 001									
	1.9 TDI	77	6J-9-000 001									
	2.0	85	6J-9-000 001									
	2.0 TDI	105	6J-9-000 001									

	1.2	44			<b>07.09</b>	PR: 1LQ,1LR,1ZG		<b>BAR22151</b>		+ 14" Rad <sup>1)</sup>	256 22,0 19,0 V L	
	1.2	51			<b>07.08</b>	PR: 1LQ,1LR,1ZG						
	1.2 TDI	55			<b>04.10</b>	PR: 1LQ,1LR,1ZG						
	1.2 TSI	77			<b>09.10</b>	PR: 1LQ,1LR,1ZG						
	1.4 i 16V	63			<b>07.08</b>	PR: 1LQ,1LR,1ZG						
	1.4 TDI	59			<b>07.08</b>	PR: 1LQ,1LR,1ZG						
	1.4 TSI FR	110			<b>06.09</b>	PR: 1LQ,1LR,1ZG						
	1.6 i 16V	77			<b>07.08</b>	PR: 1LQ,1LR,1ZG						
	1.6 LPG	60			<b>05.11</b>	PR: 1LQ,1LR,1ZG						
	1.6 TDI	66			<b>06.09</b>	PR: 1LQ,1LR,1ZG						
	1.6 TDI	77			<b>06.09</b>	PR: 1LQ,1LR,1ZG						
	1.9 TDI	66			<b>07.08</b>	PR: 1LQ,1LR,1ZG						
	1.9 TDI	77			<b>07.08</b>	PR: 1LQ,1LR,1ZG						
	2.0	85			<b>10.08</b>	PR: 1LQ,1LR,1ZG						
	2.0 TDI	105			<b>01.10</b>	PR: 1LQ,1LR,1ZG						

	1.2	44			<b>07.09</b>	PR: 1LN,1ZH		<b>BAR25113</b>		+ 15" Rad <sup>2)</sup>	288 25,0 22,0 V L	
	1.2	51			<b>07.08</b>	PR: 1LN,1ZH						
	1.2 TDI	55			<b>04.10</b>	PR: 1LN,1ZH						
	1.2 TSI	77			<b>09.10</b>	PR: 1LN,1ZH						
	1.4 i 16V	63			<b>07.08</b>	PR: 1LN,1ZH						
	1.4 TDI	59			<b>07.08</b>	PR: 1LN,1ZH						
	1.4 TSI FR	110			<b>06.09</b>	PR: 1LN,1ZH						
	1.6 i 16V	77			<b>07.08</b>	PR: 1LN,1ZH						
	1.6 LPG	60			<b>05.11</b>	PR: 1LN,1ZH						
	1.6 TDI	66			<b>06.09</b>	PR: 1LN,1ZH						
	1.6 TDI	77			<b>06.09</b>	PR: 1LN,1ZH						
	1.9 TDI	66			<b>07.08</b>	PR: 1LN,1ZH						
	1.9 TDI	77			<b>07.08</b>	PR: 1LN,1ZH						
	2.0	85			<b>10.08</b>	PR: 1LN,1ZH						
	2.0 TDI	105			<b>01.10</b>	PR: 1LN,1ZH						

	1.4 TSI Cupra	132			<b>06.09</b>	PR: 1LV		<b>BAR25123</b>			312 25,0 23,0 V L	
	1.2	44			<b>07.09</b>	PR: 1KK,1KT		<b>BA2017</b>			20961 17,2 /S	<b>LUC</b>
	1.2	51			<b>07.08</b>	PR: 1KK,1KT						
	1.2 TDI	55			<b>04.10</b>	PR: 1KK,1KT						
	1.2 TSI	77			<b>09.10</b>	PR: 1KK,1KT						
	1.4 i 16V	63			<b>07.08</b>	PR: 1KK,1KT						
	1.4 TDI	59			<b>07.08</b>	PR: 1KK,1KT						
	1.4 TSI Cupra	132			<b>06.09</b>	PR: 1KK,1KT						
	1.4 TSI FR	110			<b>06.09</b>	PR: 1KK,1KT						
	1.6 i 16V	77			<b>07.08</b>	PR: 1KK,1KT						
	1.6 LPG	60			<b>05.11</b>	PR: 1KK,1KT						
	1.6 TDI	66			<b>06.09</b>	PR: 1KK,1KT						
	1.6 TDI	77			<b>06.09</b>	PR: 1KK,1KT						
	1.9 TDI	66			<b>07.08</b>	PR: 1KK,1KT						
	1.9 TDI	77			<b>07.08</b>	PR: 1KK,1KT						

1) + 14" wheel / + ruota 14" / + roue 14" / + rueda 14"

2) + 15" wheel / + ruota 15" / + roue 15" / + rueda 15"

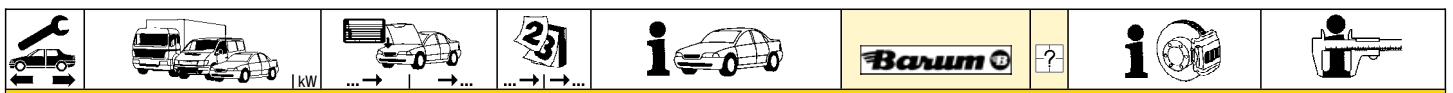













**SEAT IBIZA V / ST / SPORTCOUPE (08-)**

	2.0 2.0 TDI	85 105		<b>10.08</b> <b>01.10</b>	PR: 1KK,1KT PR: 1KK,1KT	<b>BA2017</b>			20961 17,2 /S	<b>LUC</b>
	1.4 TSI Cupra	132		<b>06.09</b>	PR: 1KP	<b>BA2017</b>			20961 17,2 /S	<b>LUC</b>
	1.2 1.4 i 16V 1.4 TDI 1.6 i 16V 1.9 TDI 1.9 TDI 2.0	51 63 59 77 66 77 85		<b>07.08</b> <b>07.08</b> <b>07.08</b> <b>07.08</b> <b>07.08</b> <b>07.08</b> <b>10.08</b>	<b>02.09</b> PR: 1KK,1KT <b>02.09</b> PR: 1KK,1KT <b>02.09</b> PR: 1KK,1KT <b>02.09</b> PR: 1KK,1KT <b>02.09</b> PR: 1KK,1KT	<b>BAR09123</b>			232 8,9 7,0	
	1.4 TSI Cupra 1.4 TSI FR	132 110		<b>06.09</b> <b>06.09</b>	PR: 1KP PR: 1KD,1KS	<b>BAR09123</b>			232 8,9 7,0	
	1.2 1.2 1.2 TDI 1.2 TSI 1.4 i 16V 1.4 TDI 1.4 TSI Cupra 1.4 TSI FR 1.6 i 16V 1.6 LPG 1.6 TDI 1.6 TDI 1.9 TDI 1.9 TDI 2.0 2.0 TDI	44 51 55 77 63 59 132 110 77 60 66 77 66 77 85 105		<b>07.09</b> <b>07.08</b> <b>04.10</b> <b>09.10</b> <b>07.08</b> <b>07.08</b> <b>06.09</b> <b>06.09</b> <b>07.08</b> <b>05.11</b> <b>06.09</b> <b>06.09</b> <b>07.08</b> <b>07.08</b> <b>10.08</b> <b>01.10</b>		<b>BAH0033</b>	2		L=140	
	1.2 1.2 1.2 TDI 1.2 TSI 1.4 i 16V 1.4 TDI 1.6 i 16V 1.6 LPG 1.9 TDI 1.9 TDI	44 51 55 77 63 59 77 60 66 77		<b>07.09</b> <b>07.08</b> <b>04.10</b> <b>09.10</b> <b>07.08</b> <b>07.08</b> <b>07.08</b> <b>05.11</b> <b>07.08</b> <b>07.08</b>	PR: 1KM PR: 1KM PR: 1KM PR: 1KM PR: 1KM PR: 1KM PR: 1KM PR: 1KM PR: 1KM PR: 1KM	<b>BAW1905</b>			Rz 19,05	
	1.2 1.2 1.2 TDI 1.2 TSI 1.4 i 16V 1.4 TDI 1.6 i 16V 1.6 LPG 1.9 TDI 1.9 TDI	44 51 55 77 63 59 77 60 66 77		<b>07.09</b> <b>07.08</b> <b>04.10</b> <b>09.10</b> <b>07.08</b> <b>07.08</b> <b>07.08</b> <b>05.11</b> <b>07.08</b> <b>07.08</b>	PR: 1KM PR: 1KM PR: 1KM PR: 1KM PR: 1KM PR: 1KM PR: 1KM PR: 1KM PR: 1KM PR: 1KM	<b>BAE5001</b>			200 x 40 HEB	<b>VW</b>

**SEAT INCA (6K9) (96-03)**

	1.4 i 1.4 i 16V 1.6 i 1.9 D 1.9 SDI / TDI	44 55 55 47	9K-T-011100	<b>11.95</b> <b>04.00</b> <b>11.95</b> <b>11.95</b> <b>11.95</b>	<b>08.03</b>	<b>BA2038</b>			20168 19,6 /S	<b>LUC</b>
	1.4 i 1.4 i 16V 1.6 i 1.7 SDI 1.9 D 1.9 SDI / TDI	44 55 55 42 47	9K-T-011101 9K-T-011101 9K-T-011101 9K-T-011101 9K-T-011101	<b>04.00</b> <b>09.96</b> <b>08.03</b> <b>08.03</b> <b>08.03</b>	<b>08.03</b> <b>08.03</b> <b>08.03</b> <b>08.03</b> <b>08.03</b>	<b>BA2018</b>			21945 16,3 /S	<b>LUC</b>
	1.4 i 1.4 i 16V 1.6 i 1.9 D 1.9 SDI / TDI	44 55 55 47	9K-T-011100 9K-T-011100 9K-T-011100 9K-T-011100	<b>11.95</b> <b>04.00</b> <b>11.95</b> <b>11.95</b> <b>11.95</b>	<b>08.03</b>	<b>BAR13178</b>			256 12,9 11,0	
	1.4 i 1.6 i 1.7 SDI 1.9 D 1.9 SDI / TDI	44 55 42 47	9K-T-011101 9K-T-011101 9K-T-011101 9K-T-011101	<b>08.03</b> <b>08.03</b> <b>09.96</b> <b>08.03</b> <b>08.03</b>	<b>08.03</b> <b>08.03</b> <b>08.03</b> <b>08.03</b> <b>08.03</b>	<b>BAR20128</b>			256 20,0 18,0 V L	
	1.4 i 1.4 i 16V 1.6 i 1.7 SDI 1.9 D 1.9 SDI / TDI	44 55 55 42 47		<b>11.95</b> <b>04.00</b> <b>11.95</b> <b>09.96</b> <b>11.95</b> <b>11.95</b>	<b>08.03</b> <b>08.03</b> <b>08.03</b> <b>08.03</b> <b>08.03</b> <b>08.03</b>	<b>BAH0005</b>	2		L=435	
	1.4 i 1.4 i 16V 1.6 i 1.7 SDI 1.9 D 1.9 SDI / TDI	44 55 55 42 47		<b>11.95</b> <b>04.00</b> <b>11.95</b> <b>09.96</b> <b>11.95</b> <b>11.95</b>	<b>08.03</b> <b>08.03</b> <b>08.03</b> <b>08.03</b> <b>08.03</b> <b>08.03</b>	<b>BAW2004</b>			Rz 20,64	

										
<b>SEAT INCA (6K9) (96-03)</b>										
	1.4 i	44	9K-X-023407	11.95			BAE5006	230 x 40 HEB	VW	
	1.4 i 16V	55		04.00	08.03					
	1.6 i	55	9K-X-023407	11.95						
	1.7 SDI	42	9K-X-023407	09.96						
	1.9 D	47	9K-X-023407	11.95						
	1.9 SDI / TDI		9K-X-023407	11.95						
	1.4 i	44	9K-X-023408		04.00	08.03		BAE5009	230 x 32 HEB	
	1.4 i 16V	55			04.00	08.03				
	1.6 i	55	9K-X-023408			08.03				
	1.7 SDI	42	9K-X-023408			08.03				
1.9 D	47	9K-X-023408			08.03					
1.9 SDI / TDI		9K-X-023408			08.03					
<b>SEAT LEON I (1M1) (99-05)</b>										
	1.4 i 16V		1M-YR006 417	11.99		PR: 1LQ,1LS	BA2154	23130 19,6 +	VW	
	1.6 i 16V		1M-YR006 417	11.99		PR: 1LQ,1LS				
	1.8 20V T	132	1M-YR006 417	11.99		PR: 1LQ,1LS				
	1.8 20V T 4x4	132	1M-YR006 417	11.99		PR: 1LQ,1LS				
	1.8 i 20V	92	1M-YR006 417	11.99		PR: 1LQ,1LS				
	1.8 T 4x4	154	1M-YR006 417	05.02		PR: 1LQ,1LS				
	1.9 SDI	50	1M-YR006 417	11.99		PR: 1LQ,1LS				
	1.9 TDI		1M-YR006 417	11.99		PR: 1LQ,1LS				
	1.9 TDI		1M-YR006 417	11.99		PR: 1LQ,1LS				
	1.9 TDI	96	1M-YR006 417	05.03		PR: 1LQ,1LS				
	1.9 TDI	110	1M-YR006 417	02.01		PR: 1LQ,1LS				
	1.9 TDI Syncro	110	1M-YR006 417	05.02		PR: 1LQ,1LS				
	2.3 VR5	110	1M-YR006 417	09.00		PR: 1LQ,1LS				
	2.8	150	1M-YR006 417	05.02		PR: 1LQ,1LS				
	1.4 i 16V		1M-YR006 418		07.05	PR: 1LS	BA2155	23131 19,6 +/WK	VW	
	1.6 i 16V		1M-YR006 418		07.05	PR: 1LS				
	1.8 20V T	132	1M-YR006 418		07.05	PR: 1LS				
1.8 20V T 4x4	132	1M-YR006 418		07.05	PR: 1LS					
1.8 i 20V	92	1M-YR006 418		07.05	PR: 1LS					
1.8 T 4x4	154	1M-YR006 418		07.05	PR: 1LS					
1.9 SDI	50	1M-YR006 418		07.05	PR: 1LS					
1.9 TDI		1M-YR006 418		07.05	PR: 1LS					
1.9 TDI		1M-YR006 418		07.05	PR: 1LS					
1.9 TDI	96	1M-YR006 418		07.05	PR: 1LS					
1.9 TDI	110	1M-YR006 418		07.05	PR: 1LS					
1.9 TDI Syncro	110	1M-YR006 418		07.05	PR: 1LS					
2.3 VR5	110	1M-YR006 418		07.05	PR: 1LS					
2.8	150	1M-YR006 418		07.05	PR: 1LS					
1.4 i 16V			11.99	07.05	PR: 1LE	BA2333	21911 20,3 +	ATE		
1.6 i 16V			11.99	07.05	PR: 1LE					
1.8 20V T	132		11.99	07.05	PR: 1LE					
1.8 20V T 4x4	132		11.99	07.05	PR: 1LE					
1.8 i 20V	92		11.99	07.05	PR: 1LE					
1.9 SDI	50		11.99	07.05	PR: 1LE					
1.9 TDI			11.99	07.05	PR: 1LE					
1.9 TDI			11.99	07.05	PR: 1LE					
1.9 TDI	96		05.03	07.05	PR: 1LE					
1.9 TDI	110		02.01	07.05	PR: 1LE					
1.9 TDI Syncro	110		05.02	07.05	PR: 1LE					
2.3 VR5	110		09.00	07.05	PR: 1LE					
2.8	150		05.02	07.05	PR: 1LE					
1.4 i 16V			11.99	07.05	PR: 1LJ,1ZQ	BA2205	23392 20,6 +/WK	ATE		
1.6 i 16V			11.99	07.05	PR: 1LJ,1ZQ					
1.8 20V T	132		11.99	07.05	PR: 1LJ,1ZQ					
1.8 20V T 4x4	132		11.99	07.05	PR: 1LJ,1ZQ					
1.8 i 20V	92		11.99	07.05	PR: 1LJ,1ZQ					
1.8 T Cupra R	154		05.02	07.05	PR: 1LT					
1.8 T Cupra R	165		07.03	07.05	PR: 1LT					
1.9 SDI	50		11.99	07.05	PR: 1LJ,1ZQ					
1.9 TDI			11.99	07.05	PR: 1LJ,1ZQ					
1.9 TDI			11.99	07.05	PR: 1LJ,1ZQ					
1.9 TDI	96		05.03	07.05	PR: 1LJ,1ZQ					
1.9 TDI	110		02.01	07.05	PR: 1LJ,1ZQ					
1.9 TDI Syncro	110		05.02	07.05	PR: 1LJ,1ZQ					
2.3 VR5	110		09.00	07.05	PR: 1LJ,1ZQ					
2.8	150		05.02	07.05	PR: 1LJ,1ZQ					
2.8 i Cupra 4x4	150		02.01	07.05	PR: 1LT					
	1.4 i 16V		11.99	07.05	PR: 1LR,1LS	BAR22150	280 22,0 19,0 V L			
	1.6 i 16V		11.99	07.05	PR: 1LR,1LS					
	1.8 20V T	132	11.99	07.05	PR: 1LR,1LS					
	1.8 20V T 4x4	132	11.99	07.05	PR: 1LR,1LS					
	1.8 i 20V	92	11.99	07.05	PR: 1LR,1LS					
	1.8 T 4x4	154	05.02	07.05	PR: 1LR,1LS					
	1.9 SDI	50	11.99	07.05	PR: 1LR,1LS					
	1.9 TDI		11.99	07.05	PR: 1LR,1LS					
	1.9 TDI		11.99	07.05	PR: 1LR,1LS					
	1.9 TDI	96	05.03	07.05	PR: 1LR,1LS					
1.9 TDI	110	02.01	07.05	PR: 1LR,1LS						
1.9 TDI Syncro	110	05.02	07.05	PR: 1LR,1LS						
2.3 VR5	110	09.00	07.05	PR: 1LR,1LS						
2.8	150	05.02	07.05	PR: 1LR,1LS						
1.4 i 16V		11.99	07.05	PR: 1LQ	BAR22151	256 22,0 19,0 V L				
1.6 i 16V		11.99	07.05	PR: 1LQ						



**SEAT LEON I (1M1) (99-05)**

	1.8 20V T	132	11.99	07.05	PR: 1LQ	BAR22151		256 22,0 19,0 V L				
	1.8 20V T 4x4	132	11.99	07.05	PR: 1LQ							
	1.8 i 20V	92	11.99	07.05	PR: 1LQ							
	1.8 T 4x4	154	05.02	07.05	PR: 1LQ							
	1.9 SDI	50	11.99	07.05	PR: 1LQ							
	1.9 TDI		11.99	07.05	PR: 1LQ							
	1.9 TDI	96	05.03	07.05	PR: 1LQ							
	1.9 TDI	110	02.01	07.05	PR: 1LQ							
	1.9 TDI Syncro	110	05.02	07.05	PR: 1LQ							
	2.3 VR5	110	09.00	07.05	PR: 1LQ							
	2.8	150	05.02	07.05	PR: 1LQ							
	1.4 i 16V		11.99	07.05	PR: 1LE				BAR25113	288 25,0 22,0 V L		
	1.6 i 16V		11.99	07.05	PR: 1LE							
	1.8 20V T	132	11.99	07.05	PR: 1LE							
	1.8 20V T 4x4	132	11.99	07.05	PR: 1LE							
1.8 i 20V	92	11.99	07.05	PR: 1LE								
1.8 T 4x4	154	05.02	07.05	PR: 1LE								
1.9 SDI	50	11.99	07.05	PR: 1LE								
1.9 TDI		11.99	07.05	PR: 1LE								
1.9 TDI	96	05.03	07.05	PR: 1LE								
1.9 TDI	110	02.01	07.05	PR: 1LE								
1.9 TDI Syncro	110	05.02	07.05	PR: 1LE								
2.3 VR5	110	09.00	07.05	PR: 1LE								
2.8	150	05.02	07.05	PR: 1LE								
1.4 i 16V		11.99	07.05	PR: 1LJ,1ZQ	BAR25123	312 25,0 23,0 V L						
1.6 i 16V		11.99	07.05	PR: 1LJ,1ZQ								
1.8 20V T	132	11.99	07.05	PR: 1LJ,1ZQ								
1.8 20V T 4x4	132	11.99	07.05	PR: 1LJ,1ZQ								
1.8 i 20V	92	11.99	07.05	PR: 1LJ,1ZQ								
1.8 T 4x4	154	05.02	07.05	PR: 1LJ,1ZQ								
1.8 T Cupra R	154	05.02	07.05	PR: 1LT								
1.8 T Cupra R	165	07.03	07.05	PR: 1LT								
1.9 SDI	50	11.99	07.05	PR: 1LJ,1ZQ								
1.9 TDI		11.99	07.05	PR: 1LJ,1ZQ								
1.9 TDI	96	05.03	07.05	PR: 1LJ,1ZQ								
1.9 TDI	110	02.01	07.05	PR: 1LJ,1ZQ								
1.9 TDI Syncro	110	05.02	07.05	PR: 1LJ,1ZQ								
2.3 VR5	110	09.00	07.05	PR: 1LJ,1ZQ								
2.8	150	05.02	07.05	PR: 1LJ,1ZQ								
2.8 i Cupra 4x4	150	02.01	07.05	PR: 1LT								
	1.4 i 16V		11.99	07.05		BAH0023	2	L=435				
	1.6 i 16V		11.99	07.05								
	1.8 20V T	132	11.99	07.05								
	1.8 20V T 4x4	132	11.99	07.05								
	1.8 i 20V	92	11.99	07.05								
	1.8 T 4x4	154	05.02	07.05								
	1.9 SDI	50	11.99	07.05								
	1.9 TDI		11.99	07.05								
	1.9 TDI	96	05.03	07.05								
	1.9 TDI	110	02.01	07.05								
	1.9 TDI Syncro	110	05.02	07.05								
	2.3 VR5	110	09.00	07.05								
	2.8	150	05.02	07.05								
		1.4 i 16V		11.99	07.05				PR: 1KK,1KP,1KQ	BA2017		20961 17,2 /S LUC
		1.6 i 16V		11.99	07.05				PR: 1KK,1KP,1KQ			
1.8 20V T		132	11.99	07.05	PR: 1KK,1KP,1KQ							
1.8 20V T 4x4		132	11.99	07.05	PR: 1KK,1KP,1KQ							
1.8 i 20V		92	11.99	07.05	PR: 1KK,1KP,1KQ							
1.8 T 4x4		154	05.02	07.05	PR: 1KK,1KP,1KQ							
1.9 SDI		50	11.99	07.05	PR: 1KK,1KP,1KQ							
1.9 TDI			11.99	07.05	PR: 1KK,1KP,1KQ							
1.9 TDI		96	05.03	07.05	PR: 1KK,1KP,1KQ							
1.9 TDI		110	02.01	07.05	PR: 1KK,1KP,1KQ							
1.9 TDI Syncro		110	05.02	07.05	PR: 1KK,1KP,1KQ							
2.3 VR5		110	09.00	07.05	PR: 1KK,1KP,1KQ							
2.8		150	05.02	07.05	PR: 1KK,1KP,1KQ							
		1.4 i 16V		11.99	07.05	PR: 1KY,2EE	BA2032		20961 15,2 /S LUC			
		1.6 i 16V		11.99	07.05	PR: 1KY,2EE						
	1.8 20V T	132	11.99	07.05	PR: 1KY,2EE							
	1.8 20V T 4x4	132	11.99	07.05	PR: 1KY,2EE							
	1.8 i 20V	92	11.99	07.05	PR: 1KY,2EE							
	1.8 T 4x4	154	05.02	07.05	PR: 1KY,2EE							
	1.8 T Cupra R	154	05.02	07.05	PR: 1KY,2EM							
	1.8 T Cupra R	165	07.03	07.05	PR: 1KY,2EM							
	1.9 SDI	50	11.99	07.05	PR: 1KY,2EE							
	1.9 TDI		11.99	07.05	PR: 1KY,2EE							
	1.9 TDI	96	05.03	07.05	PR: 1KY,2EE							
	1.9 TDI	110	02.01	07.05	PR: 1KY,2EE							
	1.9 TDI Syncro	110	05.02	07.05	PR: 1KY,2EE							
	2.3 VR5	110	09.00	07.05	PR: 1KY,2EE							
	2.8	150	05.02	07.05	PR: 1KY,2EE							



### SEAT LEON I (1M1) (99-05)













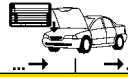





	2.8 i Cupra 4x4	150		02.01	07.05	PR: 1KY,2EM	BA2032		20961 15,2 /S	LUC		
	1.4 i 16V			11.99	07.05	PR: 1KY,2EE	BAR22163		256 22,0 20,0 V L			
	1.6 i 16V			11.99	07.05	PR: 1KY,2EE						
	1.8 20V T	132		11.99	07.05	PR: 1KY,2EE						
	1.8 20V T 4x4	132		11.99	07.05	PR: 1KY,2EE						
	1.8 i 20V	92		11.99	07.05	PR: 1KY,2EE						
	1.8 T 4x4	154		05.02	07.05	PR: 1KY,2EE						
	1.8 T Cupra R	154		05.02	07.05	PR: 1KY,2EM						
	1.8 T Cupra R	165		07.03	07.05	PR: 1KY,2EM						
	1.9 SDI	50		11.99	07.05	PR: 1KY,2EE						
	1.9 TDI			11.99	07.05	PR: 1KY,2EE						
	1.9 TDI	96		11.99	07.05	PR: 1KY,2EE						
	1.9 TDI	110		05.03	07.05	PR: 1KY,2EE						
	1.9 TDI	110		02.01	07.05	PR: 1KY,2EE						
	1.9 TDI Syncro	110		05.02	07.05	PR: 1KY,2EE						
	2.3 VR5	110		09.00	07.05	PR: 1KY,2EE						
	2.8	150		05.02	07.05	PR: 1KY,2EE						
	2.8 i Cupra 4x4	150		02.01	07.05	PR: 1KY,2EM						
	1.4 i 16V			11.99	07.05	PR: 1KK,1KP,1KQ	BAR09123		232 8,9 7,0			
	1.6 i 16V			11.99	07.05	PR: 1KK,1KP,1KQ						
	1.8 20V T	132		11.99	07.05	PR: 1KK,1KP,1KQ						
	1.8 20V T 4x4	132		11.99	07.05	PR: 1KK,1KP,1KQ						
	1.8 i 20V	92		11.99	07.05	PR: 1KK,1KP,1KQ						
	1.8 T 4x4	154		05.02	07.05	PR: 1KK,1KP,1KQ						
	1.9 SDI	50		11.99	07.05	PR: 1KK,1KP,1KQ						
	1.9 TDI			11.99	07.05	PR: 1KK,1KP,1KQ						
	1.9 TDI	96		11.99	07.05	PR: 1KK,1KP,1KQ						
	1.9 TDI	110		05.03	07.05	PR: 1KK,1KP,1KQ						
	1.9 TDI	110		02.01	07.05	PR: 1KK,1KP,1KQ						
	1.9 TDI Syncro	110		05.02	07.05	PR: 1KK,1KP,1KQ						
	2.3 VR5	110		09.00	07.05	PR: 1KK,1KP,1KQ						
	2.8	150		05.02	07.05	PR: 1KK,1KP,1KQ						
	1.4 i 16V			11.99	07.05			BAH0033		2	L=140	
	1.6 i 16V			11.99	07.05							
	1.8 20V T	132		11.99	07.05							
	1.8 i 20V	92		11.99	07.05							
	1.8 T Cupra R	154		05.02	07.05							
	1.8 T Cupra R	165		07.03	07.05							
	1.9 SDI	50		11.99	07.05							
	1.9 TDI			11.99	07.05							
	1.9 TDI	96		11.99	07.05							
	1.9 TDI	110		05.03	07.05							
	2.8	150		02.01	07.05							
	1.8 20V T 4x4	132		11.99	07.05		BAH0033	2	L=140			
	1.8 T 4x4	154		05.02	07.05							
	1.9 TDI Syncro	110		05.02	07.05							
	2.8 i Cupra 4x4	150		02.01	07.05							











### SEAT LEON II (1P1) (05-)

	1.2 TSI	77		02.10		PR: 1ZF,1ZM	BA2155		23131 19,6 +/-WK	VW
	1.4 i 16V	55		08.05		PR: 1ZF,1ZM				
	1.4 i 16V	63		06.06		PR: 1ZF,1ZM				
	1.4 TSI	92		11.07		PR: 1ZF,1ZM				
	1.6 i	75		08.05		PR: 1ZF,1ZM				
	1.6 i 16V	77		08.05		PR: 1ZF,1ZM				
	1.6 LPG	75		12.09		PR: 1ZF,1ZM				
	1.6 TDI	66		11.10		PR: 1ZF,1ZM				
	1.6 TDI Ecomotive	77		02.10		PR: 1ZF,1ZM				
	1.8 T 20V	132		08.05		PR: 1ZF,1ZM				
	1.8 T 20V	165		08.05		PR: 1ZF,1ZM				
	1.8 TSI	118		06.07		PR: 1ZF,1ZM				
	1.9 TDI			08.05		PR: 1ZF,1ZM				
	1.9 TDI	81		08.05		PR: 1ZF,1ZM				
	1.9 TDI	110		08.05		PR: 1ZF,1ZM				
	2.0 FSI	110		08.05		PR: 1ZF,1ZM				
	2.0 i 16V	100		08.05		PR: 1ZF,1ZM				
	2.0 TDI			08.05		PR: 1ZF,1ZM				
	2.0 TDI	125		02.06		PR: 1ZF,1ZM				
	2.0 TFSI			09.05		PR: 1ZF,1ZM				
	2.0 TFSI			11.06		PR: 1ZF,1ZM				
	2.0 TFSI	136		08.05		PR: 1ZF,1ZM				
	1.2 TSI	77		02.10		PR: 1ZE,1LJ	BA2195		23587 19,6 +/-WK	ATE
	1.4 i 16V	55		08.05		PR: 1ZE,1LJ				
	1.4 i 16V	63		06.06		PR: 1ZE,1LJ				
	1.4 TSI	92		11.07		PR: 1ZE,1LJ				
	1.6 i	75		08.05		PR: 1ZE,1LJ				
	1.6 i 16V	77		08.05		PR: 1ZE,1LJ				
	1.6 LPG	75		12.09		PR: 1ZE,1LJ				
	1.6 TDI	66		11.10		PR: 1ZE,1LJ				
	1.6 TDI Ecomotive	77		02.10		PR: 1ZE,1LJ				
	1.8 T 20V	132		08.05		PR: 1ZE,1LJ				
	1.8 T 20V	165		08.05		PR: 1ZE,1LJ				
	1.8 TSI	118		06.07		PR: 1ZE,1LJ				
	1.9 TDI			08.05		PR: 1ZE,1LJ				

**SEAT LEON II (1P1) (05-)**











	1.9 TDI 81 1.9 TDI 110 2.0 FSI 110 2.0 i 16V 100 2.0 TDI 125 2.0 TDI 125 2.0 TFSI 136 2.0 TFSI 136		08.05 08.05 08.05 08.05 02.06 09.05 11.06 08.05	PR: 1ZE,1LJ PR: 1ZE,1LJ PR: 1ZE,1LJ PR: 1ZE,1LJ PR: 1ZE,1LJ PR: 1ZE,1LJ PR: 1ZE,1LJ PR: 1ZE,1LJ	BA2195		23587 19,6 +WK	ATE
	1.2 TSI 77 1.4 i 16V 55 1.4 i 16V 63 1.4 TSI 92 1.6 i 75 1.6 i 16V 77 1.6 LPG 75 1.6 TDI 66 1.6 TDI Ecomotive 77 1.8 T 20V 132 1.8 T 20V 165 1.8 TSI 118 1.9 TDI 81 1.9 TDI 110 2.0 FSI 110 2.0 i 16V 100 2.0 TDI 125 2.0 TDI 125 2.0 TFSI 136 2.0 TFSI 136		02.10 08.05 06.06 11.07 08.05 08.05 12.09 11.10 02.10 08.05 08.05 06.07 08.05 08.05 08.05 08.05 08.05 08.05 02.06 09.05 11.06 08.05	PR: 1ZF,1ZM PR: 1ZF,1ZM	BAR22210		280 22,0 19,0 V L	
	1.2 TSI 77 1.4 i 16V 55 1.4 i 16V 63 1.4 TSI 92 1.6 i 75 1.6 i 16V 77 1.6 LPG 75 1.6 TDI 66 1.6 TDI Ecomotive 77 1.8 T 20V 132 1.8 T 20V 165 1.8 TSI 118 1.9 TDI 81 1.9 TDI 110 2.0 FSI 110 2.0 i 16V 100 2.0 TDI 125 2.0 TDI 125 2.0 TFSI 136 2.0 TFSI 136		02.10 08.05 06.06 11.07 08.05 08.05 12.09 11.10 02.10 08.05 08.05 06.07 08.05 08.05 08.05 08.05 08.05 02.06 09.05 11.06 08.05	PR: 1ZE PR: 1ZE	BAR25145		288 24,9 22,0 V L	
	1.2 TSI 77 1.4 i 16V 55 1.4 i 16V 63 1.4 TSI 92 1.6 i 75 1.6 i 16V 77 1.6 LPG 75 1.6 TDI 66 1.6 TDI Ecomotive 77 1.8 T 20V 132 1.8 T 20V 165 1.8 TSI 118 1.9 TDI 81 1.9 TDI 110 2.0 FSI 110 2.0 i 16V 100 2.0 TDI 125 2.0 TDI 125 2.0 TFSI 136 2.0 TFSI 136		02.10 08.05 06.06 11.07 08.05 08.05 12.09 11.10 02.10 08.05 08.05 06.07 08.05 08.05 08.05 08.05 02.06 09.05 11.06 08.05	PR: 1LJ PR: 1LJ	BAR25158		312 25,0 22,0 V L	
	1.2 TSI 77 1.4 i 16V 55 1.4 i 16V 63 1.4 TSI 92 1.6 i 75 1.6 i 16V 77 1.6 LPG 75 1.6 LPG 75 1.6 TDI 66 1.6 TDI Ecomotive 77 1.8 T 20V 132 1.8 T 20V 165 1.8 TSI 118 1.9 TDI 81 1.9 TDI 110 2.0 FSI 110 2.0 i 16V 100 2.0 TDI 125 2.0 TDI 125 2.0 TFSI 136 2.0 TFSI 136		02.10 08.05 06.06 11.07 08.05 08.05 12.09 11.06 11.10 02.10 08.05 08.05 06.07 08.05 08.05 08.05 02.06 09.05 11.06 08.05	PR: 1KD PR: 1KD	BA2017		20961 17,2 /S	LUC
↓								















								
<b>SEAT LEON II (1P1) (05-)</b>								
	1.8 TSI 118 1.9 TDI 1.9 TDI 81 1.9 TDI 110 2.0 FSI 110 2.0 i 16V 100 2.0 TDI 2.0 TDI 125 2.0 TFSI 2.0 TFSI 136		06.07 08.05 08.05 08.05 08.05 08.05 02.06 09.05 08.05	PR: 1KD PR: 1KD PR: 1KD PR: 1KD PR: 1KD PR: 1KD PR: 1KD PR: 1KD PR: 1KD	BA2017			20961 17,2 /S LUC
	1.2 TSI 77 1.4 i 16V 55 1.4 i 16V 63 1.4 TSI 92 1.6 i 75 1.6 i 16V 77 1.6 LPG 75 1.6 TDI 66 1.6 TDI Ecomotive 77 1.8 T 20V 132 1.8 T 20V 165 1.8 TSI 118 1.9 TDI 1.9 TDI 81 1.9 TDI 110 2.0 FSI 110 2.0 i 16V 100 2.0 TDI 2.0 TDI 125 2.0 TFSI 2.0 TFSI 136		02.10 08.05 06.06 11.07 08.05 08.05 12.09 11.10 02.10 08.05 08.05 06.07 08.05 08.05 08.05 08.05 02.06 09.05 11.06 08.05	PR: 1KY,1KZ PR: 1KY,1KZ PR: 1KY,1KZ PR: 1KY,1KZ PR: 1KY,1KZ PR: 1KY,1KZ PR: 1KY,1KZ PR: 1KY,1KZ PR: 1KY,1KZ PR: 1KY,1KZ PR: 1KY,1KZ PR: 1KY,1KZ PR: 1KY,1KZ PR: 1KY,1KZ PR: 1KY,1KZ PR: 1KY,1KZ PR: 1KY,1KZ PR: 1KY,1KZ PR: 1KY,1KZ PR: 1KY,1KZ	BA2196			23914 16,3 /WE/S LUC
	1.2 TSI 77 1.4 i 16V 55 1.4 i 16V 63 1.4 TSI 92 1.6 i 75 1.6 i 16V 77 1.6 LPG 75 1.6 TDI 66 1.6 TDI Ecomotive 77 1.8 T 20V 132 1.8 T 20V 165 1.8 TSI 118 1.9 TDI 1.9 TDI 81 1.9 TDI 110 2.0 FSI 110 2.0 i 16V 100 2.0 TDI 2.0 TDI 125 2.0 TFSI 2.0 TFSI 136		02.10 08.05 06.06 11.07 08.05 08.05 12.09 11.10 02.10 08.05 08.05 06.07 08.05 08.05 08.05 08.05 02.06 09.05 11.06 08.05	PR: 1KY,1KZ PR: 1KY,1KZ PR: 1KY,1KZ PR: 1KY,1KZ PR: 1KY,1KZ PR: 1KY,1KZ PR: 1KY,1KZ PR: 1KY,1KZ PR: 1KY,1KZ PR: 1KY,1KZ PR: 1KY,1KZ PR: 1KY,1KZ PR: 1KY,1KZ PR: 1KY,1KZ PR: 1KY,1KZ PR: 1KY,1KZ PR: 1KY,1KZ PR: 1KY,1KZ PR: 1KY,1KZ PR: 1KY,1KZ	BAR12169			282 12,0 10,0
<b>SEAT MALAGA (85-92)</b>								
	1.2 1.5 1.5 i 1.7 D		09.85 12.92 09.85 12.92 09.87 12.92 09.85 12.92		BA2064 BA2065			20775 18,0 /WE 20775 18,0 /WK BDX BDX
<b>SEAT MARBELLA (87-98)</b>								
	0.8 0.9		01.87 12.92 01.87 10.98		BA2064			20775 18,0 /WE BDX
	0.8 0.9		01.87 12.92 01.87 10.98		BAW1902			Rz 19,05
<b>SEAT Mii (12-)</b>								
	1.0 44 1.0 55		05.12 05.12		BA2154			23130 19,6 + VW
	1.0 44 1.0 55		05.12 05.12		BAW1701	2		Rz 17,46
	1.0 44 1.0 55		05.12 05.12		BAE5001			200 x 40 HEB VW
<b>SEAT TERRA (87-96)</b>								
	0.9 1.3 D 1.4 D		03.87 12.96 03.90 12.96 01.90 12.96		BA2064			20775 18,0 /WE BDX



















SEAT TERRA (87-96)									
	0.9 1.3 D 1.4 D			09.90 09.90 09.90	12.96 12.96 12.96	BAW1902			Rz 19,05
SEAT TOLEDO I (1L) (91-98)									
	1.6 i 1.8 i 1.9 D 1.9 TD	55		09.91 09.91 09.91 09.91	09.98 09.98 09.98 09.98	BA2132			20887 19,7 +/Zub VW
	1.6 i 1.8 i 1.8 i 16V 1.9 TDI 2.0 i	1L-TR017000		09.91 09.91 09.91 09.91 09.91	09.98 09.98 03.94 09.98 09.98	BA2037			20168 16,3 /S LUC
	1.9 TDI 2.0 i 16V	1L-TR016999		04.95 03.94	09.98 09.98	BA2038			20168 19,6 /S LUC
	1.6 i 1.8 i 1.9 D 1.9 TD	55		09.91 09.91 09.91 09.91	09.98 09.98 09.98 09.98	BAR12106			239 12,0 10,0
	1.9 TDI	1L-TR016999		04.95	09.98	BAR13178			256 12,9 11,0
	1.6 i 1.8 i 1.8 i 16V 1.9 TDI 2.0 i	1L-TR017000		09.91 09.91 09.91 09.91 09.91	09.98 09.98 03.94 09.98 09.98	BAR20128			256 20,0 18,0 V L
	2.0 i 16V			03.94	09.98	BAR22100			280 22,0 20,0 V L
	1.6 i 1.8 i 1.9 D 1.9 TD 1.9 TDI	55	1L-ZD342000 1L-ZD342000 1L-ZD342000 1L-ZD342000 1L-ZD342000	09.91 09.91 09.91 09.91 04.95	09.91 09.91 09.91 09.91 09.91	BAH0010	2		L=310
	1.8 i 16V 2.0 i		1L-ZD328000	09.91 11.96	03.94 09.98	BA2032			20961 15,2 /S LUC
	1.9 TDI 2.0 i 2.0 i 16V	1L-ZD328001		11.96 03.94	09.98 09.98	BA2017			20961 17,2 /S LUC
	1.8 i 16V 1.9 TDI 2.0 i			09.91 11.96 09.91	03.94 09.98 09.98	BAR10111		ohne Sensorring <sup>1)</sup>	226 10,0 8,0
	2.0 i 16V			03.94	09.98	BAR10203			226 10,0 8,0
	1.6 i 1.8 i 1.9 D 1.9 TD 1.9 TDI	55		09.91 09.91 09.91 09.91 04.95	09.98 09.98 09.98 09.98 09.98	BAH0011	2		L=160
	1.8 i 16V 2.0 i 2.0 i 16V			09.91 09.91 03.94	03.94 09.98 09.98	BAH0003	2		L=160
	1.6 i 1.8 i 1.9 D 1.9 TD 1.9 TDI	55		09.91 09.91 09.91 09.91 04.95	09.98 09.98 09.98 09.98 09.98	BAW1701		+ GG <sup>2)</sup>	Rz 17,46
	1.6 i 1.6 i 1.8 i 1.9 D 1.9 TD 1.9 TDI	1L-ZD310000 1L-ZD310001		09.91 09.91 09.91 09.91 04.95	09.91 09.98 09.98 09.98 09.98	BAE5003 BAE5001			180 x 31 HEB 200 x 40 HEB VW
SEAT TOLEDO II (1M2) (98-04)									
	1.4 i 16V 1.6 i 1.8 Allrad 1.8 i 20V 1.8 i 20VT 1.9 SDI 1.9 TDI 1.9 TDI 1.9 TDI 1.9 TDI 2.3 i V5 2.8 2.8 4x4	55 132 50 66 81 96 110 150 150		07.99 10.98 05.01 10.98 05.01 11.99 10.98 05.03 10.00 10.98 10.00 05.02	09.04 09.04 09.04 09.04 09.04 09.04 09.04 09.04 09.04 09.04 09.04 09.04	PR: 1LQ PR: 1LQ PR: 1LQ PR: 1LQ PR: 1LQ PR: 1LQ PR: 1LQ PR: 1LQ PR: 1LQ PR: 1LQ PR: 1LQ	BA2154		23130 19,6 + VW
	1.4 i 16V 1.6 i 1.8 Allrad 1.8 i 20V 1.8 i 20VT 1.9 SDI 1.9 TDI 1.9 TDI 1.9 TDI	55 132 50 66 81 96		07.99 10.98 05.01 10.98 05.01 11.99 10.98 05.03	09.04 09.04 09.04 09.04 09.04 09.04 09.04 09.04	PR: 1LR,1LS PR: 1LR,1LS PR: 1LR,1LS PR: 1LR,1LS PR: 1LR,1LS PR: 1LR,1LS PR: 1LR,1LS PR: 1LR,1LS	BA2155		23131 19,6 +/WK VW

<sup>1)</sup> without sensor ring / senza sensori / sans secours ABS / sin anillo sensor ABS







<sup>2)</sup> + cast iron / + ghisa / + fonte grise / + fundición de gris

        									
SEAT TOLEDO II (1M2) (98-04)									
	1.9 TDI 110		10.00	09.04	PR: 1LR,1LS	BA2155		23131 19,6 +/WK	VW
	2.3 i V5 150		10.98	09.04	PR: 1LR,1LS				
	2.8 150		10.00	09.04	PR: 1LR,1LS				
	2.8 4x4 150		05.02	09.04	PR: 1LR,1LS				
	1.4 i 16V 55	X-800 000	07.99	09.04	PR: 1LN,1LE,1ZE,1ZH	BA2333		21911 20,3 +	ATE
	1.6 i 55	X-800 000	10.98	09.04	PR: 1LN,1LE,1ZE,1ZH				
	1.8 Allrad 55	X-800 000	05.01	09.04	PR: 1LN,1LE,1ZE,1ZH				
	1.8 i 20V 55	X-800 000	10.98	09.04	PR: 1LN,1LE,1ZE,1ZH				
	1.8 i 20VT 132	X-800 000	05.01	09.04	PR: 1LN,1LE,1ZE,1ZH				
	1.9 SDI 50	X-800 000	11.99	09.04	PR: 1LN,1LE,1ZE,1ZH				
	1.9 TDI 66	X-800 000	10.98	09.04	PR: 1LN,1LE,1ZE,1ZH				
	1.9 TDI 81	X-800 000	10.98	09.04	PR: 1LN,1LE,1ZE,1ZH				
	1.9 TDI 96	X-800 000	05.03	09.04	PR: 1LN,1LE,1ZE,1ZH				
	1.9 TDI 110	X-800 000	10.00	09.04	PR: 1LN,1LE,1ZE,1ZH				
	2.3 i V5 150	X-800 000	10.98	09.04	PR: 1LN,1LE,1ZE,1ZH				
	2.8 150	X-800 000	10.00	09.04	PR: 1LN,1LE,1ZE,1ZH				
	2.8 4x4 150	X-800 000	05.02	09.04	PR: 1LN,1LE,1ZE,1ZH				
	1.4 i 16V 55	Y-000 001		09.04	PR: 1LN,1LE,1ZE,1ZH	BA2205		23392 20,6 +/WK	ATE
	1.6 i 55	Y-000 001		09.04	PR: 1LN,1LE,1ZE,1ZH				
	1.8 Allrad 55	Y-000 001		09.04	PR: 1LN,1LE,1ZE,1ZH				
1.8 i 20V 55	Y-000 001		09.04	PR: 1LN,1LE,1ZE,1ZH					
1.8 i 20VT 132	Y-000 001		09.04	PR: 1LN,1LE,1ZE,1ZH					
1.9 SDI 50	Y-000 001		09.04	PR: 1LN,1LE,1ZE,1ZH					
1.9 TDI 66	Y-000 001		09.04	PR: 1LN,1LE,1ZE,1ZH					
1.9 TDI 81	Y-000 001		09.04	PR: 1LN,1LE,1ZE,1ZH					
1.9 TDI 96	Y-000 001		09.04	PR: 1LN,1LE,1ZE,1ZH					
1.9 TDI 110	Y-000 001		09.04	PR: 1LN,1LE,1ZE,1ZH					
2.3 i V5 150	Y-000 001		09.04	PR: 1LN,1LE,1ZE,1ZH					
2.8 150	Y-000 001		09.04	PR: 1LN,1LE,1ZE,1ZH					
2.8 4x4 150	Y-000 001		09.04	PR: 1LN,1LE,1ZE,1ZH					
1.4 i 16V 55		07.99	09.04	PR: 1LJ,1ZQ	BA2205		23392 20,6 +/WK	ATE	
1.6 i 55		10.98	09.04	PR: 1LJ,1ZQ					
1.8 Allrad 55		05.01	09.04	PR: 1LJ,1ZQ					
1.8 i 20V 55		10.98	09.04	PR: 1LJ,1ZQ					
1.8 i 20VT 132		05.01	09.04	PR: 1LJ,1ZQ					
1.9 SDI 50		11.99	09.04	PR: 1LJ,1ZQ					
1.9 TDI 66		04.99	09.04	PR: 1LJ,1ZQ					
1.9 TDI 81		10.98	09.04	PR: 1LJ,1ZQ					
1.9 TDI 96		05.03	09.04	PR: 1LJ,1ZQ					
1.9 TDI 110		10.00	09.04	PR: 1LJ,1ZQ					
2.3 i V5 150		10.98	09.04	PR: 1LJ,1ZQ					
2.8 150		10.00	09.04	PR: 1LJ,1ZQ					
2.8 4x4 150		05.02	09.04	PR: 1LJ,1ZQ					
	1.4 i 16V 55		07.99	09.04	PR: 1LQ	BAR22151		256 22,0 19,0 V L	
	1.6 i 55		10.98	09.04	PR: 1LQ				
	1.8 Allrad 55		05.01	09.04	PR: 1LQ				
	1.8 i 20V 55		10.98	09.04	PR: 1LQ				
	1.8 i 20VT 132		05.01	09.04	PR: 1LQ				
	1.9 SDI 50		11.99	09.04	PR: 1LQ				
	1.9 TDI 66		10.98	09.04	PR: 1LQ				
	1.9 TDI 81		10.98	09.04	PR: 1LQ				
	1.9 TDI 96		05.03	09.04	PR: 1LQ				
	1.9 TDI 110		10.00	09.04	PR: 1LQ				
	2.3 i V5 150		10.98	09.04	PR: 1LQ				
	2.8 150		10.00	09.04	PR: 1LQ				
	2.8 4x4 150		05.02	09.04	PR: 1LQ				
	1.4 i 16V 55		07.99	09.04	PR: 1LR,1LS	BAR22150		280 22,0 19,0 V L	
	1.6 i 55		10.98	09.04	PR: 1LR,1LS				
	1.8 Allrad 55		05.01	09.04	PR: 1LR,1LS				
	1.8 i 20V 55		10.98	09.04	PR: 1LR,1LS				
	1.8 i 20VT 132		05.01	09.04	PR: 1LR,1LS				
	1.9 SDI 50		11.99	09.04	PR: 1LR,1LS				
	1.9 TDI 66		10.98	09.04	PR: 1LR,1LS				
1.9 TDI 81		10.98	09.04	PR: 1LR,1LS					
1.9 TDI 96		05.03	09.04	PR: 1LR,1LS					
1.9 TDI 110		10.00	09.04	PR: 1LR,1LS					
2.3 i V5 150		10.98	09.04	PR: 1LR,1LS					
2.8 150		10.00	09.04	PR: 1LR,1LS					
2.8 4x4 150		05.02	09.04	PR: 1LR,1LS					
1.4 i 16V 55		07.99	09.04	PR: 1LJ,1ZQ	BAR25123		312 25,0 23,0 V L		
1.6 i 55		10.98	09.04	PR: 1LJ,1ZQ					
1.8 Allrad 55		05.01	09.04	PR: 1LJ,1ZQ					
1.8 i 20V 55		10.98	09.04	PR: 1LJ,1ZQ					
1.8 i 20VT 132		05.01	09.04	PR: 1LJ,1ZQ					
1.9 SDI 50		11.99	09.04	PR: 1LJ,1ZQ					
1.9 TDI 66		04.99	09.04	PR: 1LJ,1ZQ					
1.9 TDI 81		10.98	09.04	PR: 1LJ,1ZQ					
1.9 TDI 96		05.03	09.04	PR: 1LJ,1ZQ					
1.9 TDI 110		10.00	09.04	PR: 1LJ,1ZQ					
2.3 i V5 150		10.98	09.04	PR: 1LJ,1ZQ					
2.8 150		10.00	09.04	PR: 1LJ,1ZQ					
2.8 4x4 150		05.02	09.04	PR: 1LJ,1ZQ					
1.4 i 16V 55		07.99	09.04	PR: 1LN,1LE,1ZE,1ZH	BAR25113		288 25,0 22,0 V L		
1.6 i 55		10.98	09.04	PR: 1LN,1LE,1ZE,1ZH					
1.8 Allrad 55		05.01	09.04	PR: 1LN,1LE,1ZE,1ZH					
1.8 i 20V 55		10.98	09.04	PR: 1LN,1LE,1ZE,1ZH					



								
<b>SEAT TOLEDO II (1M2) (98-04)</b>								
	1.8 i 20VT 1.9 SDI 1.9 TDI 1.9 TDI 1.9 TDI 1.9 TDI 2.3 i V5 2.8 2.8 4x4	132 50 66 81 96 110  150 150		05.01 09.04 11.99 09.04 04.99 09.04 10.98 09.04 05.03 09.04 10.00 09.04 10.98 09.04 10.00 09.04 05.02 09.04	PR: 1LN,1LE,1ZE,1ZH PR: 1LN,1LE,1ZE,1ZH PR: 1LN,1LE,1ZE,1ZH PR: 1LN,1LE,1ZE,1ZH PR: 1LN,1LE,1ZE,1ZH PR: 1LN,1LE,1ZE,1ZH PR: 1LN,1LE,1ZE,1ZH PR: 1LN,1LE,1ZE,1ZH		BAR25113	288 25,0 22,0 V L
	1.4 i 16V 1.6 i 1.8 Allrad 1.8 i 20V 1.8 i 20VT 1.9 SDI 1.9 TDI 1.9 TDI 1.9 TDI 1.9 TDI 2.3 i V5 2.8 2.8 4x4	55   132 50 66 81 96 110  150 150		07.99 09.04 10.98 09.04 05.01 09.04 10.98 09.04 05.01 09.04 11.99 09.04 10.98 09.04 10.98 09.04 05.03 09.04 10.00 09.04 10.98 09.04 10.00 09.04 05.02 09.04			BAH0023	2 L=435
	1.4 i 16V 1.6 i 1.8 Allrad 1.8 i 20V 1.8 i 20VT 1.9 SDI 1.9 TDI 1.9 TDI 1.9 TDI 1.9 TDI 2.3 i V5 2.8 2.8 4x4	55   132 50 66 81 96 110  150 150		07.99 09.04 10.98 09.04 05.01 09.04 10.98 09.04 05.01 09.04 11.99 09.04 10.98 09.04 10.98 09.04 05.03 09.04 10.00 09.04 10.98 09.04 10.00 09.04 05.02 09.04	PR: 1KK,1KP,1KQ PR: 1KK,1KP,1KQ PR: 1KK,1KP,1KQ PR: 1KK,1KP,1KQ PR: 1KK,1KP,1KQ PR: 1KK,1KP,1KQ PR: 1KK,1KP,1KQ PR: 1KK,1KP,1KQ PR: 1KK,1KP,1KQ PR: 1KK,1KP,1KQ PR: 1KK,1KP,1KQ PR: 1KK,1KP,1KQ		BA2017	20961 17,2 /S LUC
	1.4 i 16V 1.6 i 1.8 Allrad 1.8 i 20V 1.8 i 20VT 1.9 SDI 1.9 TDI 1.9 TDI 1.9 TDI 1.9 TDI 2.3 i V5 2.8 2.8 4x4	55   132 50 66 81 96 110  150 150		07.99 09.04 10.98 09.04 05.01 09.04 10.98 09.04 05.01 09.04 11.99 09.04 10.98 09.04 10.98 09.04 05.03 09.04 10.00 09.04 10.98 09.04 10.00 09.04 05.02 09.04	PR: 1KY,2EE PR: 1KY,2EE PR: 1KY,2EE PR: 1KY,2EE PR: 1KY,2EE PR: 1KY,2EE PR: 1KY,2EE PR: 1KY,2EE PR: 1KY,2EE PR: 1KY,2EE PR: 1KY,2EE PR: 1KY,2EE		BA2032	20961 15,2 /S LUC
	1.4 i 16V 1.6 i 1.8 Allrad 1.8 i 20V 1.8 i 20VT 1.9 SDI 1.9 TDI 1.9 TDI 1.9 TDI 1.9 TDI 2.3 i V5 2.8 2.8 4x4	55   132 50 66 81 96 110  150 150		07.99 09.04 10.98 09.04 05.01 09.04 10.98 09.04 05.01 09.04 11.99 09.04 10.98 09.04 10.98 09.04 05.03 09.04 10.00 09.04 10.98 09.04 10.00 09.04 05.02 09.04	PR: 1KK,1KP,1KQ PR: 1KK,1KP,1KQ PR: 1KK,1KP,1KQ PR: 1KK,1KP,1KQ PR: 1KK,1KP,1KQ PR: 1KK,1KP,1KQ PR: 1KK,1KP,1KQ PR: 1KK,1KP,1KQ PR: 1KK,1KP,1KQ PR: 1KK,1KP,1KQ PR: 1KK,1KP,1KQ PR: 1KK,1KP,1KQ		BAR09123	232 8,9 7,0
	1.4 i 16V 1.6 i 1.8 Allrad 1.8 i 20V 1.8 i 20VT 1.9 SDI 1.9 TDI 1.9 TDI 1.9 TDI 1.9 TDI 2.3 i V5 2.8 2.8 4x4	55   132 50 66 81 96 110  150 150		07.99 09.04 10.98 09.04 05.01 09.04 10.98 09.04 05.01 09.04 11.99 09.04 10.98 09.04 10.98 09.04 05.03 09.04 10.00 09.04 10.98 09.04 10.00 09.04 05.02 09.04	PR: 1KY,2EE PR: 1KY,2EE PR: 1KY,2EE PR: 1KY,2EE PR: 1KY,2EE PR: 1KY,2EE PR: 1KY,2EE PR: 1KY,2EE PR: 1KY,2EE PR: 1KY,2EE PR: 1KY,2EE PR: 1KY,2EE		BAR22163	256 22,0 20,0 V L
	1.4 i 16V 1.6 i 1.8 i 20V 1.8 i 20VT 1.9 SDI 1.9 TDI 1.9 TDI 1.9 TDI 1.9 TDI 2.3 i V5 2.8	55   132 50 66 81 96 110  150		07.99 09.04 10.98 09.04 10.98 09.04 05.01 09.04 11.99 09.04 10.98 09.04 10.98 09.04 05.03 09.04 10.00 09.04 10.98 09.04 10.00 09.04			BAH0033	2 L=140
	1.8 Allrad			05.01 09.04			BAH0033	2 L=140



















	   kW								
<b>SEAT TOLEDO II (1M2) (98-04)</b>									
	2.8 4x4	150	05.02	09.04	BAH0033	2		L=140	
<b>SEAT TOLEDO III (5P2) (05-09)</b>									
	1.6 i 16V	75	10.04	03.09	PR: 12F	BA2155		23131 19,6 +/WK	VW
	1.8 TFSI	118	01.07	03.09	PR: 12F				
	1.9 TDI	77	10.04	03.09	PR: 12F				
	2.0 FSI	110	10.04	03.09	PR: 12F				
	2.0 i 16V	100	10.04	03.09	PR: 12F				
	2.0 TDI	125	10.04	03.09	PR: 12F				
	2.0 TDI	125	01.06	03.09	PR: 12F				
	2.0 TFSI	147	11.05	03.09	PR: 12F				
	1.6 i 16V	75	10.04	03.09	PR: 12E	BA2195		23587 19,6 +/WK	ATE
	1.8 TFSI	118	01.07	03.09	PR: 12E				
	1.9 TDI	77	10.04	03.09	PR: 12E				
	2.0 FSI	110	10.04	03.09	PR: 12E				
	2.0 i 16V	100	10.04	03.09	PR: 12E				
	2.0 TDI	125	10.04	03.09	PR: 12E				
	2.0 TDI	125	01.06	03.09	PR: 12E				
	2.0 TFSI	147	11.05	03.09	PR: 12E				
	1.6 i 16V	75	10.04	03.09	PR: 12F	BAR22210		280 22,0 19,0 V L	
	1.8 TFSI	118	01.07	03.09	PR: 12F				
	1.9 TDI	77	10.04	03.09	PR: 12F				
	2.0 FSI	110	10.04	03.09	PR: 12F				
	2.0 i 16V	100	10.04	03.09	PR: 12F				
	2.0 TDI	125	10.04	03.09	PR: 12F				
	2.0 TDI	125	01.06	03.09	PR: 12F				
	2.0 TFSI	147	11.05	03.09	PR: 12F				
	1.6 i 16V	75	10.04	03.09	PR: 12E	BAR25145		288 24,9 22,0 V L	
	1.8 TFSI	118	01.07	03.09	PR: 12E				
	1.9 TDI	77	10.04	03.09	PR: 12E				
	2.0 FSI	110	10.04	03.09	PR: 12E				
	2.0 i 16V	100	10.04	03.09	PR: 12E				
	2.0 TDI	125	10.04	03.09	PR: 12E				
	2.0 TDI	125	01.06	03.09	PR: 12E				
	2.0 TFSI	147	11.05	03.09	PR: 12E				
	1.6 i 16V	75	10.04	03.09	PR: 1KD	BA2017		20961 17,2 /S	LUC
	1.8 TFSI	118	01.07	03.09	PR: 1KD				
	1.9 TDI	77	10.04	03.09	PR: 1KD				
	2.0 FSI	110	10.04	03.09	PR: 1KD				
	2.0 i 16V	100	10.04	03.09	PR: 1KD				
	2.0 TDI	125	10.04	03.09	PR: 1KD				
	2.0 TDI	125	01.06	03.09	PR: 1KD				
	2.0 TFSI	147	11.05	03.09	PR: 1KD				
	1.6 i 16V	75	10.04	03.09	PR: 1KF,1KJ,1KZ	BA2196		23914 16,3 /WE/S	LUC
	1.8 TFSI	118	01.07	03.09	PR: 1KF,1KJ,1KZ				
	1.9 TDI	77	10.04	03.09	PR: 1KF,1KJ,1KZ				
	2.0 FSI	110	10.04	03.09	PR: 1KF,1KJ,1KZ				
	2.0 i 16V	100	10.04	03.09	PR: 1KF,1KJ,1KZ				
	2.0 TDI	125	10.04	03.09	PR: 1KF,1KJ,1KZ				
	2.0 TDI	125	01.06	03.09	PR: 1KF,1KJ,1KZ				
	2.0 TFSI	147	11.05	03.09	PR: 1KF,1KJ,1KZ				
	1.6 i 16V	75	10.04	03.09	PR: 1KJ,1KZ	BAR12169		282 12,0 10,0	
	1.8 TFSI	118	01.07	03.09	PR: 1KJ,1KZ				
	1.9 TDI	77	10.04	03.09	PR: 1KJ,1KZ				
	2.0 FSI	110	10.04	03.09	PR: 1KJ,1KZ				
	2.0 i 16V	100	10.04	03.09	PR: 1KJ,1KZ				
	2.0 TDI	125	10.04	03.09	PR: 1KJ,1KZ				
	2.0 TDI	125	01.06	03.09	PR: 1KJ,1KZ				
	2.0 TFSI	147	11.05	03.09	PR: 1KJ,1KZ				
	1.6 i 16V	75	10.04	03.09	PR: 1KF	BAR12158		256 12,0 10,0	
	1.8 TFSI	118	01.07	03.09	PR: 1KF				
	1.9 TDI	77	10.04	03.09	PR: 1KF				
	2.0 FSI	110	10.04	03.09	PR: 1KF				
	2.0 i 16V	100	10.04	03.09	PR: 1KF				
	2.0 TDI	125	10.04	03.09	PR: 1KF				
	2.0 TDI	125	01.06	03.09	PR: 1KF				
	2.0 TFSI	147	11.05	03.09	PR: 1KF				
<b>SKODA CITIGO (12-)</b>									
	1.0	44	05.12			BA2154		23130 19,6 +	VW
	1.0	55	05.12						
	1.0	44	05.12			BAW1701	2	Rz 17,46	
	1.0	55	05.12						
	1.0	44	05.12			BAE5001		200 x 40 HEB	VW
	1.0	55	05.12						































SKODA FABIA I (6Y) (99-07)									
	1.0 i		02.00	08.02	PR: 1LB,1LM	BA2152		21866 17,3 +	VW
	1.2 i		08.02	12.07	PR: 1LB,1LM				
	1.4 i		02.00	12.07	PR: 1LB,1LM				
	1.4 i 16V		10.99	12.07	PR: 1LB,1LM				
	1.4 TDI		04.03	12.07	PR: 1LB,1LM				
	1.9 SDI	47	12.99	12.07	PR: 1LB,1LM				
	1.9 TDI	74	02.00	12.07	PR: 1LB,1LM				
	2.0 i	85	12.99	12.07	PR: 1LB,1LM				
	RS 1.9 TDI	96	09.03	12.07	PR: 1LB,1LM				
	1.0 i		02.00	08.02	PR: 1LQ,1LR		BA2154 BA2155		
1.2 i		08.02	12.07	PR: 1LQ,1LR					
1.4 i		02.00	12.07	PR: 1LQ,1LR					
1.4 i 16V		10.99	12.07	PR: 1LQ,1LR					
1.4 TDI		04.03	12.07	PR: 1LQ,1LR					
1.9 SDI	47	12.99	12.07	PR: 1LQ,1LR					
1.9 TDI	74	02.00	12.07	PR: 1LQ,1LR					
2.0 i	85	12.99	12.07	PR: 1LQ,1LR					
RS 1.9 TDI	96	09.03	12.07	PR: 1LQ,1LR					
1.0 i		02.00	08.02	PR: 1LN,1LP	BA2298			23843 18,8 +/WK/S	LUC
1.2 i		08.02	12.07	PR: 1LN,1LP					
1.4 i		02.00	12.07	PR: 1LN,1LP					
1.4 i 16V		10.99	12.07	PR: 1LN,1LP					
1.4 TDI		04.03	12.07	PR: 1LN,1LP					
1.9 SDI	47	12.99	12.07	PR: 1LN,1LP					
1.9 TDI	74	02.00	12.07	PR: 1LN,1LP					
2.0 i	85	12.99	12.07	PR: 1LN,1LP					
RS 1.9 TDI	96	09.03	12.07	PR: 1LN,1LP					
	1.0 i		02.00	08.02		PR: 1LB,1LM	BAR18137		
	1.2 i		08.02	12.07	PR: 1LB,1LM				
	1.4 i		02.00	12.07	PR: 1LB,1LM				
	1.4 i 16V		10.99	12.07	PR: 1LB,1LM				
	1.4 TDI		04.03	12.07	PR: 1LB,1LM				
	1.9 SDI	47	12.99	12.07	PR: 1LB,1LM				
	1.9 TDI	74	02.00	12.07	PR: 1LB,1LM				
	2.0 i	85	12.99	12.07	PR: 1LB,1LM				
	RS 1.9 TDI	96	09.03	12.07	PR: 1LB,1LM				
	1.0 i		02.00	08.02	PR: 1LQ,1LR	BAR22151			256 22,0 19,0 V L
1.2 i		08.02	12.07	PR: 1LQ,1LR					
1.4 i		02.00	12.07	PR: 1LQ,1LR					
1.4 i 16V		10.99	12.07	PR: 1LQ,1LR					
1.4 TDI		04.03	12.07	PR: 1LQ,1LR					
1.9 SDI	47	12.99	12.07	PR: 1LQ,1LR					
1.9 TDI	74	02.00	12.07	PR: 1LQ,1LR					
2.0 i	85	12.99	12.07	PR: 1LQ,1LR					
RS 1.9 TDI	96	09.03	12.07	PR: 1LQ,1LR					
1.0 i		02.00	08.02	PR: 1LN,1LP	BAR25113			288 25,0 22,0 V L	
1.2 i		08.02	12.07	PR: 1LN,1LP					
1.4 i		02.00	12.07	PR: 1LN,1LP					
1.4 i 16V		10.99	12.07	PR: 1LN,1LP					
1.4 TDI		04.03	12.07	PR: 1LN,1LP					
1.9 SDI	47	12.99	12.07	PR: 1LN,1LP					
1.9 TDI	74	02.00	12.07	PR: 1LN,1LP					
2.0 i	85	12.99	12.07	PR: 1LN,1LP					
RS 1.9 TDI	96	09.03	12.07	PR: 1LN,1LP					
	1.4 i 16V		10.99	12.07		PR: 1KK,1KP	BA2017		
	1.4 TDI		04.03	12.07	PR: 1KK,1KP				
	1.9 TDI	74	02.00	12.07	PR: 1KK,1KP				
	2.0 i	85	12.99	12.07	PR: 1KK,1KP				
	RS 1.9 TDI	96	09.03	12.07	PR: 1KK,1KP				
	1.4 i 16V		10.99	12.07	PR: 1KK,1KP	BAR09123		232 8,9 7,0	
	1.4 TDI		04.03	12.07	PR: 1KK,1KP				
	1.9 TDI	74	02.00	12.07	PR: 1KK,1KP				
	2.0 i	85	12.99	12.07	PR: 1KK,1KP				
	RS 1.9 TDI	96	09.03	12.07	PR: 1KK,1KP				
	1.0 i		02.00	08.02	PR: 1KK,1KP	BAH0033	2	L=140	
	1.2 i		08.02	12.07	PR: 1KK,1KP				
	1.4 i		02.00	12.07	PR: 1KK,1KP				
	1.4 i 16V		10.99	12.07	PR: 1KK,1KP				
	1.4 TDI		04.03	12.07	PR: 1KK,1KP				
	1.9 SDI	47	12.99	12.07	PR: 1KK,1KP				
	1.9 TDI	74	02.00	12.07	PR: 1KK,1KP				
	2.0 i	85	12.99	12.07	PR: 1KK,1KP				
	RS 1.9 TDI	96	09.03	12.07	PR: 1KK,1KP				
		1.0 i		02.00	08.02				
1.2 i			08.02	12.07					
1.4 i			02.00	12.07					
1.4 i 16V			10.99	12.07					
1.4 TDI			04.03	12.07					
1.9 SDI		47	12.99	12.07					
	1.0 i		02.00	08.02		BAE5001		200 x 40 HEB	VW
	1.2 i		08.02	12.07					
	1.4 i		02.00	12.07					
	1.4 i 16V		10.99	12.07					
	1.4 TDI		04.03	12.07					
	1.9 SDI	47	12.99	12.07					

**SKODA FABIA II (5J) (07-)**















	1.2	44	03.07	PR: 1LB,1LM	BA2152		21866 17,3 +	VW
	1.2	51	03.07	PR: 1LB,1LM				
	1.2 TDI	55	05.10	PR: 1LB,1LM				
	1.2 TSI	63	03.10	PR: 1LB,1LM				
	1.2 TSI	77	03.10	PR: 1LB,1LM				
	1.4 i 16V	63	03.07	PR: 1LB,1LM				
	1.4 TDI	51	03.07	PR: 1LB,1LM				
	1.4 TDI	59	03.07	PR: 1LB,1LM				
	1.4 TSI RS	132	05.10	PR: 1LB,1LM				
	1.6 i 16V	77	03.07	PR: 1LB,1LM				
	1.6 TDI	55	04.10	PR: 1LB,1LM				
	1.6 TDI	66	03.10	PR: 1LB,1LM				
	1.6 TDI	77	03.10	PR: 1LB,1LM				
	1.9 TDI	77	03.07	PR: 1LB,1LM				
	1.2	44	03.07	PR: 1LQ,1LR	BA2154 BA2155		23130 19,6 + 23131 19,6 +/WK	VW VW
	1.2	51	03.07	PR: 1LQ,1LR				
	1.2 TDI	55	05.10	PR: 1LQ,1LR				
	1.2 TSI	63	03.10	PR: 1LQ,1LR				
	1.2 TSI	77	03.10	PR: 1LQ,1LR				
	1.4 i 16V	63	03.07	PR: 1LQ,1LR				
	1.4 TDI	51	03.07	PR: 1LQ,1LR				
	1.4 TDI	59	03.07	PR: 1LQ,1LR				
	1.4 TSI RS	132	05.10	PR: 1LQ,1LR				
	1.6 i 16V	77	03.07	PR: 1LQ,1LR				
	1.6 TDI	55	04.10	PR: 1LQ,1LR				
	1.6 TDI	66	03.10	PR: 1LQ,1LR				
	1.6 TDI	77	03.10	PR: 1LQ,1LR				
	1.9 TDI	77	03.07	PR: 1LQ,1LR				
	1.2	44	03.07	PR: 1LN,1ZH	BA2298		23843 18,8 +/WK/S	LUC
	1.2	51	03.07	PR: 1LN,1ZH				
	1.2 TDI	55	05.10	PR: 1LN,1ZH				
	1.2 TSI	63	03.10	PR: 1LN,1ZH				
	1.2 TSI	77	03.10	PR: 1LN,1ZH				
	1.4 i 16V	63	03.07	PR: 1LN,1ZH				
	1.4 TDI	51	03.07	PR: 1LN,1ZH				
	1.4 TDI	59	03.07	PR: 1LN,1ZH				
	1.4 TSI RS	132	05.10	PR: 1LN,1ZH				
	1.6 i 16V	77	03.07	PR: 1LN,1ZH				
	1.6 TDI	55	04.10	PR: 1LN,1ZH				
	1.6 TDI	66	03.10	PR: 1LN,1ZH				
	1.6 TDI	77	03.10	PR: 1LN,1ZH				
	1.9 TDI	77	03.07	PR: 1LN,1ZH				
	1.2	44	03.07	PR: 1LB,1LM	BAR18137		239 18,0 16,0 V L	
	1.2	51	03.07	PR: 1LB,1LM				
	1.2 TDI	55	05.10	PR: 1LB,1LM				
	1.2 TSI	63	03.10	PR: 1LB,1LM				
	1.2 TSI	77	03.10	PR: 1LB,1LM				
	1.4 i 16V	63	03.07	PR: 1LB,1LM				
	1.4 TDI	51	03.07	PR: 1LB,1LM				
	1.4 TDI	59	03.07	PR: 1LB,1LM				
	1.4 TSI RS	132	05.10	PR: 1LB,1LM				
	1.6 i 16V	77	03.07	PR: 1LB,1LM				
	1.6 TDI	55	04.10	PR: 1LB,1LM				
	1.6 TDI	66	03.10	PR: 1LB,1LM				
	1.6 TDI	77	03.10	PR: 1LB,1LM				
	1.9 TDI	77	03.07	PR: 1LB,1LM				
	1.2	44	03.07	PR: 1LQ,1LR	BAR22151		256 22,0 19,0 V L	
	1.2	51	03.07	PR: 1LQ,1LR				
	1.2 TDI	55	05.10	PR: 1LQ,1LR				
	1.2 TSI	63	03.10	PR: 1LQ,1LR				
	1.2 TSI	77	03.10	PR: 1LQ,1LR				
	1.4 i 16V	63	03.07	PR: 1LQ,1LR				
	1.4 TDI	51	03.07	PR: 1LQ,1LR				
	1.4 TDI	59	03.07	PR: 1LQ,1LR				
	1.4 TSI RS	132	05.10	PR: 1LQ,1LR				
	1.6 i 16V	77	03.07	PR: 1LQ,1LR				
	1.6 TDI	55	04.10	PR: 1LQ,1LR				
	1.6 TDI	66	03.10	PR: 1LQ,1LR				
	1.6 TDI	77	03.10	PR: 1LQ,1LR				
	1.9 TDI	77	03.07	PR: 1LQ,1LR				
	1.2	44	03.07	PR: 1LN,1ZH	BAR25113		288 25,0 22,0 V L	
	1.2	51	03.07	PR: 1LN,1ZH				
	1.2 TDI	55	05.10	PR: 1LN,1ZH				
	1.2 TSI	63	03.10	PR: 1LN,1ZH				
	1.2 TSI	77	03.10	PR: 1LN,1ZH				
	1.4 i 16V	63	03.07	PR: 1LN,1ZH				
	1.4 TDI	51	03.07	PR: 1LN,1ZH				
	1.4 TDI	59	03.07	PR: 1LN,1ZH				
	1.4 TSI RS	132	05.10	PR: 1LN,1ZH				
	1.6 i 16V	77	03.07	PR: 1LN,1ZH				
	1.6 TDI	55	04.10	PR: 1LN,1ZH				
	1.6 TDI	66	03.10	PR: 1LN,1ZH				
	1.6 TDI	77	03.10	PR: 1LN,1ZH				
	1.9 TDI	77	03.07	PR: 1LN,1ZH				

	   kW							
<b>SKODA FABIA II (5J) (07-)</b>								
	1.2 1.2 1.2 TDI 1.2 TSI 1.2 TSI 1.4 i 16V 1.4 TDI 1.4 TDI 1.4 TSI RS 1.6 i 16V 1.6 TDI 1.6 TDI 1.6 TDI 1.9 TDI	44 51 55 63 77 63 51 59 132 77 55 66 77 77	03.07 03.07 05.10 03.10 03.10 03.07 03.07 03.07 05.10 03.07 04.10 03.10 03.10 03.07	PR: 1KK,1KT,1KV PR: 1KK,1KT,1KV PR: 1KT,1KV PR: 1KT,1KV PR: 1KT,1KV PR: 1KK,1KT,1KV PR: 1KK,1KT,1KV PR: 1KT,1KV PR: 1KK,1KT,1KV PR: 1KT,1KV PR: 1KT,1KV PR: 1KT,1KV PR: 1KT,1KV PR: 1KK,1KT,1KV	BA2017			20961 17,2 /S LUC
	1.2 1.2 1.4 i 16V 1.4 TDI 1.4 TDI 1.6 i 16V 1.9 TDI	44 51 63 51 59 77 77	03.07 03.07 03.07 03.07 03.07 03.07 03.07	05.09 PR: 1KK 05.09 PR: 1KK 05.09 PR: 1KK 05.09 PR: 1KK 05.09 PR: 1KK 05.09 PR: 1KK	BAR09123			232 8,9 7,0
	1.2 1.2 1.2 TDI 1.2 TSI 1.2 TSI 1.4 i 16V 1.4 TDI 1.4 TDI 1.4 TSI RS 1.6 i 16V 1.6 TDI 1.6 TDI 1.6 TDI 1.9 TDI	44 51 55 63 77 63 51 59 132 77 55 66 77 77	03.07 03.07 05.10 03.10 03.10 03.07 03.07 03.07 05.10 03.07 04.10 03.10 03.10 03.07		BAH0033	2		L=140
	1.2 1.2 1.2 TDI 1.2 TSI 1.2 TSI 1.4 i 16V 1.4 TDI 1.4 TDI 1.6 i 16V 1.6 TDI 1.6 TDI 1.6 TDI 1.9 TDI	44 51 55 63 77 63 51 59 77 55 66 77 77	03.07 03.07 05.10 03.10 03.10 03.07 03.07 03.07 03.07 04.10 03.10 03.10 03.07		BAW1905			Rz 19,05
	1.2 1.2 1.2 TDI 1.2 TSI 1.2 TSI 1.4 i 16V 1.4 TDI 1.4 TDI 1.6 i 16V 1.6 TDI 1.6 TDI 1.6 TDI 1.9 TDI	44 51 55 63 77 63 51 59 77 55 66 77 77	03.07 03.07 05.10 03.10 03.10 03.07 03.07 03.07 03.07 04.10 03.10 03.10 03.07		BAE5001			200 x 40 HEB VW
<b>SKODA FAVORIT (781) (87-95)</b>								
	135 136		08.87 08.87	12.95 12.95	BA2039			20861 17,5 /S LUC
	135 136		04.94 04.94	12.95 12.95	BAR13182			236 12,8 11,4
	135 136		01.93 01.93	12.95 12.95	BAE5001			200 x 40 HEB VW
<b>SKODA FELICIA I (791/795) (95-97)</b>								
	1.3 (135) 1.3 i (136) 1.6 i 1.9 D	50	10.94 10.94 08.95 10.96	02.98 02.98 02.98 02.98	BA2039			20861 17,5 /S LUC
	1.3 (135) 1.3 i (136) 1.6 i 1.9 D	50	10.94 10.94 08.95 10.96	02.98 02.98 02.98 02.98	BAR13182			236 12,8 11,4

								
<b>SKODA FELICIA I (791/795) (95-97)</b>								
	1.3 (135) 1.3 i (136) 1.6 i 1.9 D	50	10.94 10.94 08.95 10.96	02.98 02.98 02.98 02.98	BAE5001			200 x 40 HEB <b>VW</b>
<b>SKODA FELICIA II (6U) (98-01)</b>								
	1.3 i 1.6 i 1.9 D		03.98 03.98 03.98	08.01 08.01 08.01	BA2039			20861 17,5 /S <b>LUC</b>
	1.3 i 1.6 i 1.9 D		03.98 03.98 03.98	08.01 08.01 08.01	BAR13182			236 12,8 11,4
	1.3 i 1.6 i 1.9 D		03.98 03.98 03.98	08.01 08.01 08.01	BAE5001			200 x 40 HEB <b>VW</b>
<b>SKODA FELICIA PICK-UP (797) (97-00)</b>								
	1.3 1.3 1.6 1.9 D	40 50 55 47	06.97 06.97 06.97 06.97	12.00 12.00 12.99 12.00	BA2039			20861 17,5 /S <b>LUC</b>
	1.3 1.3 1.6 1.9 D	40 50 55 47	06.97 06.97 06.97 06.97	12.00 12.00 12.99 12.00	BAR13182			236 12,8 11,4
	1.3 1.3 1.6 1.9 D	40 50 55 47	06.97 06.97 06.97 06.97	12.00 12.00 12.99 12.00	BAE5001			200 x 40 HEB <b>VW</b>
<b>SKODA FORMAN (785) (91-95)</b>								
	1.3 1.3 i		09.91 02.94	12.95 12.95	BA2039			20861 17,5 /S <b>LUC</b>
	1.3 i		04.94	12.95	BAR13182			236 12,8 11,4
	1.3 1.3 i		01.93 02.94	12.95 12.95	BAE5001			200 x 40 HEB <b>VW</b>
<b>SKODA OCTAVIA I (1U) (97-10)</b>								
	1.4 i 1.6 i 1.8 i 20V 1.8 i 20V Turbo 1.9 SDI 1.9 TDI 1.9 TDI 2.0 i	92 110 66 81	1U-X-415000 04.99 1U-X-415000 10.96 1U-X-415000 10.96 1U-X-415000 03.98 1U-X-415000 05.97 1U-X-415000 10.96 1U-X-415000 08.97 1U-X-415000 04.99	PR: 1LQ,1LR,1LS,1ZM PR: 1LQ,1LR,1LS,1ZM PR: 1LQ,1LR,1LS,1ZM PR: 1LQ,1LR,1LS,1ZM PR: 1LQ,1LR,1LS,1ZM PR: 1LQ,1LR,1LS,1ZM PR: 1LQ,1LR,1LS,1ZM PR: 1LQ,1LR,1LS,1ZM	BA2154			23130 19,6 + <b>VW</b>
	1.4 i 1.6 i 1.8 i 20V 1.8 i 20V Turbo 1.8 i 20V Turbo 4x4 1.9 SDI 1.9 TDI 1.9 TDI 1.9 TDI 1.9 TDI 4x4 2.0 i 2.0 i 4x4 2.0 i 4x4	1U-Y-000001 1U-Y-000001 92 1U-Y-000001 110 1U-Y-000001 110 1U-Y-000001 66 1U-Y-000001 74 1U-Y-000001 81 1U-Y-000001 96 1U-Y-000001 1U-Y-000001 85 1U-Y-000001 88 1U-Y-000001	06.10 06.10 06.10 06.10 06.10 06.10 08.00 06.10 06.10 01.03 11.99 06.10 05.01 06.10	PR: 1LQ,1LR,1LS,1ZM PR: 1LQ,1LR,1LS,1ZM PR: 1LQ,1LR,1LS,1ZM PR: 1LQ,1LR,1LS,1ZM PR: 1LQ,1LR,1LS,1ZM PR: 1LQ,1LR,1LS,1ZM PR: 1LQ,1LR,1LS,1ZM PR: 1LQ,1LR,1LS,1ZM PR: 1LQ,1LR,1LS,1ZM PR: 1LQ,1LR,1LS,1ZM PR: 1LQ,1LR,1LS,1ZM PR: 1LQ,1LR,1LS,1ZM PR: 1LQ,1LR,1LS,1ZM PR: 1LQ,1LR,1LS,1ZM	BA2155			23131 19,6 +/WK <b>VW</b>
	1.4 i 1.6 i 1.8 i 20V 1.8 i 20V Turbo 1.8 i 20V Turbo 4x4 1.9 SDI 1.9 TDI 1.9 TDI 1.9 TDI 1.9 TDI 4x4 2.0 i 2.0 i 4x4 2.0 i 4x4 RS 1.8 T 20V	92 110 110 66 74 81 96 85 88 132	04.99 10.96 10.96 03.98 05.01 05.97 10.96 08.00 08.97 01.03 11.99 04.99 05.01 01.00 05.01	PR: 1LN,1LE,1ZD,1ZE,1ZH PR: 1LN,1LE,1ZD,1ZE,1ZH PR: 1LN,1LE,1ZD,1ZE,1ZH PR: 1LN,1LE,1ZD,1ZE,1ZH PR: 1LN,1LE,1ZD,1ZE,1ZH PR: 1LN,1LE,1ZD,1ZE,1ZH PR: 1LN,1LE,1ZD,1ZE,1ZH PR: 1LN,1LE,1ZD,1ZE,1ZH PR: 1LN,1LE,1ZD,1ZE,1ZH PR: 1LN,1LE,1ZD,1ZE,1ZH PR: 1LN,1LE,1ZD,1ZE,1ZH PR: 1LN,1LE,1ZD,1ZE,1ZH PR: 1LN,1LE,1ZD,1ZE,1ZH PR: 1LN,1LE,1ZD,1ZE,1ZH PR: 1LN,1LE,1ZD,1ZE,1ZH	BA2333 BA2205			21911 20,3 + 23392 20,6 +/WK <b>ATE</b> <b>ATE</b>
	1.4 i 1.6 i 1.8 i 20V 1.8 i 20V Turbo 1.8 i 20V Turbo 4x4 1.9 SDI 1.9 TDI	92 110 110 66	04.99 10.96 10.96 03.98 05.01 05.97 10.96	PR: 1LQ PR: 1LQ PR: 1LQ PR: 1LQ PR: 1LQ PR: 1LQ	BAR22151			256 22,0 19,0 VL

SKODA OCTAVIA I (1U) (97-10)									
	1.9 TDI 74 1.9 TDI 81 1.9 TDI 96 1.9 TDI 4x4 2.0 i 2.0 i 4x4 85 2.0 i 4x4 88		08.00 08.97 01.03 11.99 04.99 05.01 01.00	06.10 PR: 1LQ 06.10 PR: 1LQ 06.10 PR: 1LQ 06.10 PR: 1LQ 06.10 PR: 1LQ 06.10 PR: 1LQ 06.10 PR: 1LQ	BAR22151			256 22,0 19,0 V L	
	1.4 i 1.6 i 1.8 i 20V 92 1.8 i 20V Turbo 110 1.8 i 20V Turbo 4x4 110 1.9 SDI 1.9 TDI 66 1.9 TDI 74 1.9 TDI 81 1.9 TDI 96 1.9 TDI 4x4 2.0 i 2.0 i 4x4 85 2.0 i 4x4 88		04.99 10.96 10.96 03.98 05.01 05.97 10.96 08.00 08.97 01.03 11.99 04.99 05.01 01.00	06.10 PR: 1LR,1LS,1ZM 06.10 PR: 1LR,1LS,1ZM 06.10 PR: 1LR,1LS,1ZM 06.10 PR: 1LR,1LS,1ZM 06.10 PR: 1LR,1LS,1ZM 06.10 PR: 1LR,1LS,1ZM 06.10 PR: 1LR,1LS,1ZM 06.10 PR: 1LR,1LS,1ZM 06.10 PR: 1LR,1LS,1ZM 06.10 PR: 1LR,1LS,1ZM 06.10 PR: 1LR,1LS,1ZM 06.10 PR: 1LR,1LS,1ZM 06.10 PR: 1LR,1LS,1ZM 06.10 PR: 1LR,1LS,1ZM	BAR22150			280 22,0 19,0 V L	
	1.4 i 1.6 i 1.8 i 20V 92 1.8 i 20V Turbo 110 1.8 i 20V Turbo 4x4 110 1.9 SDI 1.9 TDI 66 1.9 TDI 74 1.9 TDI 81 1.9 TDI 96 1.9 TDI 4x4 2.0 i 2.0 i 4x4 85 2.0 i 4x4 88		04.99 10.96 10.96 03.98 05.01 05.97 10.96 08.00 08.97 01.03 11.99 04.99 05.01 01.00	06.10 PR: 1LE,1LN,1ZE,1ZH 06.10 PR: 1LE,1LN,1ZE,1ZH 06.10 PR: 1LE,1LN,1ZE,1ZH 06.10 PR: 1LE,1LN,1ZE,1ZH 06.10 PR: 1LE,1LN,1ZE,1ZH 06.10 PR: 1LE,1LN,1ZE,1ZH 06.10 PR: 1LE,1LN,1ZE,1ZH 06.10 PR: 1LE,1LN,1ZE,1ZH 06.10 PR: 1LE,1LN,1ZE,1ZH 06.10 PR: 1LE,1LN,1ZE,1ZH 06.10 PR: 1LE,1LN,1ZE,1ZH 06.10 PR: 1LE,1LN,1ZE,1ZH 06.10 PR: 1LE,1LN,1ZE,1ZH 06.10 PR: 1LE,1LN,1ZE,1ZH	BAR25113			288 25,0 22,0 V L	
	RS 1.8 T 20V 132		05.01	06.10 PR: 1ZN	BAR25123			312 25,0 23,0 V L	
	1.4 i 1.6 i 1.8 i 20V 92 1.8 i 20V Turbo 110 1.9 SDI 1.9 TDI 66 1.9 TDI 74 1.9 TDI 81 1.9 TDI 96 2.0 i		04.99 10.96 10.96 03.98 05.97 10.96 08.00 08.97 01.03 04.99	06.10 06.10 06.10 06.10 06.10 06.10 06.10 06.10 06.10 06.10	BAH0023	2		L=435	
	1.6 i 1.8 i 20V 92 1.8 i 20V Turbo 110 1.8 i 20V Turbo 4x4 110 1.9 SDI 1.9 TDI 66 1.9 TDI 74 1.9 TDI 81 1.9 TDI 96 1.9 TDI 4x4 2.0 i 2.0 i 4x4 85 2.0 i 4x4 88		10.96 10.96 03.98 05.01 05.97 08.97 08.00 08.97 01.03 11.99 04.99 05.01 01.00	06.10 PR: 1KK,1KS,1KP 06.10 PR: 1KK,1KS,1KP 06.10 PR: 1KK,1KS,1KP 06.10 PR: 1KE 06.10 PR: 1KK,1KS,1KP 06.10 PR: 1KK,1KS,1KP 06.10 PR: 1KK,1KS,1KP 06.10 PR: 1KK,1KS,1KP 06.10 PR: 1KK,1KS,1KP 06.10 PR: 1KE 06.10 PR: 1KK,1KS,1KP 06.10 PR: 1KE 06.10 PR: 1KE	BA2017			20961 17,2 /S	LUC
	RS 1.8 T 20V 132		01.03	06.10 PR: 2ED	BA2032			20961 15,2 /S	LUC
	1.6 i 1.8 i 20V 92 1.8 i 20V Turbo 110 1.9 SDI 1.9 TDI 66 1.9 TDI 74 1.9 TDI 81 1.9 TDI 96 2.0 i 1.8 i 20V Turbo 4x4 110 1.9 TDI 4x4 2.0 i 4x4 85 2.0 i 4x4 88	1U-W-130 000 1U-W-130 000 1U-W-130 000 1U-W-130 000	10.96 08.00 08.97 01.03 04.99 05.01 11.99 05.01 01.00	06.10 PR: 1KP 06.10 PR: 1KP 06.10 PR: 1KP 06.10 PR: 1KP 06.10 PR: 1KP 06.10 PR: 1KP 06.10 PR: 1KP 06.10 PR: 1KP 06.10 PR: 1KP 06.10 PR: 1KE 06.10 PR: 1KE 06.10 PR: 1KE	BAR09123			232 8,9 7,0	
	1.8 i 20V Turbo 4x4 110 1.9 TDI 4x4 2.0 i 4x4 85 2.0 i 4x4 88		05.01 11.99 05.01 01.00	06.10 PR: 1KE 06.10 PR: 1KE 06.10 PR: 1KE 06.10 PR: 1KE	BAR09133			239 8,9 7,0	
	RS 1.8 T 20V 132		01.03	06.10 PR: 2ED	BAR22163			256 22,0 20,0 V L	
	1.4 i 1.6 i 1.8 i 20V 92 1.8 i 20V Turbo 110 1.9 SDI 1.9 TDI 66 1.9 TDI 74 1.9 TDI 81 1.9 TDI 96 2.0 i RS 1.8 T 20V 132		04.99 10.96 10.96 03.98 05.97 10.96 08.00 08.97 01.03 04.99 05.01	06.10 06.10 06.10 06.10 06.10 06.10 06.10 06.10 06.10 06.10 06.10	BAH0033	2		L=140	
	1.8 i 20V Turbo 4x4 110		05.01	06.10	BAH0033	2		L=140	

<b>SKODA OCTAVIA I (1U) (97-10)</b>																	
	1.9 TDI 4x4			<b>11.99</b>	<b>06.10</b>					<b>BAH0033</b>		2					L=140
	2.0 i 4x4	85		<b>05.01</b>	<b>06.10</b>												
	2.0 i 4x4	88		<b>01.00</b>	<b>06.10</b>												
	1.4 i			<b>04.99</b>	<b>06.10</b>	PR: 1KG				<b>BAW2004</b>							Rz 20,64
	1.6 i			<b>10.96</b>	<b>06.10</b>	PR: 1KG											
	1.9 SDI			<b>05.97</b>	<b>06.10</b>	PR: 1KG											
	1.9 TDI	66		<b>10.96</b>	<b>06.10</b>	PR: 1KG											
	1.4 i			<b>04.99</b>	<b>06.10</b>	PR: 1KN				<b>BAW1905</b>							Rz 19,05
	1.6 i			<b>10.96</b>	<b>06.10</b>	PR: 1KN											
	1.9 SDI			<b>05.97</b>	<b>06.10</b>	PR: 1KN											
	1.9 TDI	66		<b>10.96</b>	<b>06.10</b>	PR: 1KN											
	1.4 i			<b>04.99</b>	<b>06.10</b>	PR: 1KN,1KG				<b>BAE5009</b>							230 x 32 HEB
	1.6 i			<b>10.96</b>	<b>06.10</b>	PR: 1KN,1KG											
	1.9 SDI			<b>05.97</b>	<b>06.10</b>	PR: 1KN,1KG											
	1.9 TDI	66		<b>10.96</b>	<b>06.10</b>	PR: 1KN,1KG											
<b>SKODA OCTAVIA II (1Z) (04-)</b>																	
	1.2 TSI	77		<b>02.10</b>		PR: 1ZF,1ZM,1ZC				<b>BA2155</b>							<b>23131</b> 19,6 +/WK <b>VW</b>
	1.4 i 16V			<b>06.04</b>		PR: 1ZF,1ZM,1ZC											
	1.4 TSI	90		<b>11.08</b>		PR: 1ZF,1ZM,1ZC											
	1.6	75		<b>09.09</b>		PR: 1ZF,1ZM,1ZC											
	1.6 FSI	85		<b>06.04</b>		PR: 1ZF,1ZM,1ZC											
	1.6 i 16V	75		<b>06.04</b>		PR: 1ZF,1ZM,1ZC											
	1.6 TDI	77		<b>06.09</b>		PR: 1ZF,1ZM,1ZC											
	1.6 TDI 4x4	77		<b>06.09</b>		PR: 1ZF,1ZM,1ZC											
	1.8 TSI			<b>06.07</b>		PR: 1ZF,1ZM,1ZC											
	1.8 TSI 4x4			<b>11.08</b>		PR: 1ZF,1ZM,1ZC											
	1.9 TDI	77		<b>06.04</b>		PR: 1ZF,1ZM,1ZC											
	1.9 TDI 4x4	77		<b>11.04</b>		PR: 1ZF,1ZM,1ZC											
	2.0 FSI	110		<b>11.04</b>		PR: 1ZF,1ZM,1ZC											
	2.0 FSI 4x4	110		<b>11.04</b>		PR: 1ZF,1ZM,1ZC											
	2.0 TDI	81		<b>03.10</b>		PR: 1ZF,1ZM,1ZC											
	2.0 TDI	100		<b>06.04</b>		PR: 1ZF,1ZM,1ZC											
	2.0 TDI	103		<b>06.04</b>		PR: 1ZF,1ZM,1ZC											
	2.0 TDi 4x4	81		<b>05.11</b>		PR: 1ZF,1ZM,1ZC											
	2.0 TDI 4x4	103		<b>07.06</b>		PR: 1ZF,1ZM,1ZC											
	2.0 TDI RS	125		<b>04.06</b>		PR: 1ZF,1ZM,1ZC											
	1.2 TSI	77		<b>02.10</b>		PR: 1ZE				<b>BA2195</b>							<b>23587</b> 19,6 +/WK <b>ATE</b>
	1.4 i 16V			<b>06.04</b>		PR: 1ZE											
	1.4 TSI	90		<b>11.08</b>		PR: 1ZE											
	1.6	75		<b>09.09</b>		PR: 1ZE											
	1.6 FSI	85		<b>06.04</b>		PR: 1ZE											
	1.6 i 16V	75		<b>06.04</b>		PR: 1ZE											
	1.6 TDI	77		<b>06.09</b>		PR: 1ZE											
	1.6 TDI 4x4	77		<b>06.09</b>		PR: 1ZE											
	1.8 TSI			<b>06.07</b>		PR: 1ZE											
	1.8 TSI 4x4			<b>11.08</b>		PR: 1ZE											
	1.9 TDI	77		<b>06.04</b>		PR: 1ZE											
	1.9 TDI 4x4	77		<b>11.04</b>		PR: 1ZE											
	2.0 FSI	110		<b>11.04</b>		PR: 1ZE											
	2.0 FSI 4x4	110		<b>11.04</b>		PR: 1ZE											
	2.0 RS	147		<b>10.05</b>		PR: 1LL,1LP											
	2.0 TDI	81		<b>03.10</b>		PR: 1ZE											
	2.0 TDI	100		<b>06.04</b>		PR: 1ZE											
	2.0 TDI	103		<b>06.04</b>		PR: 1ZE											
	2.0 TDi 4x4	81		<b>05.11</b>		PR: 1ZE											
	2.0 TDI 4x4	103		<b>07.06</b>		PR: 1ZE											
	2.0 TDI RS	125		<b>04.06</b>		PR: 1ZE,1LL,1LP											
	1.2 TSI	77		<b>02.10</b>		PR: 1ZF,1ZM				<b>BAR22210</b>							<b>280</b> 22,0 19,0 V L
	1.4 i 16V			<b>06.04</b>		PR: 1ZF,1ZM											
	1.4 TSI	90		<b>11.08</b>		PR: 1ZF,1ZM											
	1.6	75		<b>09.09</b>		PR: 1ZF,1ZM											
	1.6 FSI	85		<b>06.04</b>		PR: 1ZF,1ZM											
	1.6 i 16V	75		<b>06.04</b>		PR: 1ZF,1ZM											
	1.6 TDI	77		<b>06.09</b>		PR: 1ZF,1ZM											
	1.6 TDI 4x4	77		<b>06.09</b>		PR: 1ZF,1ZM											
	1.8 TSI			<b>06.07</b>		PR: 1ZF,1ZM											
	1.8 TSI 4x4			<b>11.08</b>		PR: 1ZF,1ZM											
	1.9 TDI	77		<b>06.04</b>		PR: 1ZF,1ZM											
	1.9 TDI 4x4	77		<b>11.04</b>		PR: 1ZF,1ZM											
	2.0 FSI	110		<b>11.04</b>		PR: 1ZF,1ZM											
	2.0 FSI 4x4	110		<b>11.04</b>		PR: 1ZF,1ZM											
	2.0 TDI	81		<b>03.10</b>		PR: 1ZF,1ZM											
	2.0 TDI	100		<b>06.04</b>		PR: 1ZF,1ZM											
	2.0 TDI	103		<b>06.04</b>		PR: 1ZF,1ZM											
	2.0 TDi 4x4	81		<b>05.11</b>		PR: 1ZF,1ZM											
	2.0 TDI 4x4	103		<b>07.06</b>		PR: 1ZF,1ZM											
	2.0 TDI RS	125		<b>04.06</b>		PR: 1ZF,1ZM											
	1.2 TSI	77		<b>02.10</b>		PR: 1ZE				<b>BAR25145</b>							<b>288</b> 24,9 22,0 V L
	1.4 i 16V			<b>06.04</b>		PR: 1ZE											
	1.4 TSI	90		<b>11.08</b>		PR: 1ZE											
	1.6	75		<b>09.09</b>		PR: 1ZE											
	1.6 FSI	85		<b>06.04</b>		PR: 1ZE											
	1.6 i 16V	75		<b>06.04</b>		PR: 1ZE											
	1.6 TDI	77		<b>06.09</b>		PR: 1ZE											
	1.6 TDI 4x4	77		<b>06.09</b>		PR: 1ZE											
	1.8 TSI			<b>06.07</b>		PR: 1ZE											

	   kW									
<b>SKODA OCTAVIA II (1Z) (04-)</b>										
	1.8 TSI 4x4		11.08	PR: 1ZE	BAR25145			288 24,9 22,0 VL		
	1.9 TDI	77	06.04	PR: 1ZE						
	1.9 TDI 4x4	77	11.04	PR: 1ZE						
	2.0 FSI	110	11.04	PR: 1ZE						
	2.0 FSI 4x4	110	11.04	PR: 1ZE						
	2.0 TDI	81	03.10	PR: 1ZE						
	2.0 TDI	100	06.04	PR: 1ZE						
	2.0 TDI	103	06.04	PR: 1ZE						
	2.0 TDi 4x4	81	05.11	PR: 1ZE						
	2.0 TDi 4x4	103	07.06	PR: 1ZE						
2.0 TDI RS	125	04.06	PR: 1ZE							
2.0 RS	147	10.05	PR: 1LL,1LP	BAR25158			312 25,0 22,0 VL			
2.0 TDI RS	125	04.06	PR: 1LL,1LP							
	1.2 TSI	77	02.10	PR: 1KD	BA2017			20961 17,2 /S LUC		
	1.4 i 16V		06.04	PR: 1KD						
	1.4 TSI	90	11.08	PR: 1KD						
	1.6	75	09.09	PR: 1KD						
	1.6 FSI	85	06.04	PR: 1KD						
	1.6 i 16V	75	06.04	PR: 1KD						
	1.6 TDI	77	06.09	PR: 1KD						
	1.8 TSI		06.07	PR: 1KD						
	1.9 TDI	77	06.04	PR: 1KD						
	2.0 FSI	110	11.04	PR: 1KD						
	2.0 TDI	81	03.10	PR: 1KD						
	2.0 TDI	100	06.04	PR: 1KD						
	2.0 TDI	103	06.04	PR: 1KD						
	2.0 TDi 4x4	81	05.11	PR: 1KD						
	2.0 TDI RS	125	04.08	PR: 1KD						
	1.2 TSI	77	02.10	PR: 1KF		BA2196				23914 16,3 /WE/S LUC
	1.4 i 16V		06.04	PR: 1KF						
	1.4 TSI	90	11.08	PR: 1KF						
	1.6	75	09.09	PR: 1KF						
	1.6 FSI	85	06.04	PR: 1KF						
1.6 i 16V	75	06.04	PR: 1KF							
1.6 TDI	77	06.09	PR: 1KF							
1.6 TDI 4x4	77	06.09	PR: 1KF							
1.8 TSI		06.07	PR: 1KF							
1.8 TSI 4x4		11.08	PR: 1KF							
1.9 TDI	77	06.04	PR: 1KF							
1.9 TDI 4x4	77	11.04	PR: 1KF							
2.0 FSI	110	11.04	PR: 1KF							
2.0 FSI 4x4	110	11.04	PR: 1KF							
2.0 RS	147	10.05	PR: 1KP							
2.0 TDI	81	03.10	PR: 1KF							
2.0 TDI	100	06.04	PR: 1KF							
2.0 TDI	103	06.04	PR: 1KF							
2.0 TDi 4x4	81	05.11	PR: 1KF							
2.0 TDi 4x4	103	07.06	PR: 1KF							
2.0 TDI RS	125	04.06	PR: 1KF,1KP							
	1.2 TSI	77	02.10	PR: 1KF	BAR12158			256 12,0 10,0		
	1.4 i 16V		06.04	PR: 1KF						
	1.4 TSI	90	11.08	PR: 1KF						
	1.6	75	09.09	PR: 1KF						
	1.6 FSI	85	06.04	PR: 1KF						
	1.6 i 16V	75	06.04	PR: 1KF						
	1.6 TDI	77	06.09	PR: 1KF						
	1.6 TDI 4x4	77	06.09	PR: 1KF						
	1.8 TSI		06.07	PR: 1KF						
	1.8 TSI 4x4		11.08	PR: 1KF						
	1.9 TDI	77	06.04	PR: 1KF						
	1.9 TDI 4x4	77	11.04	PR: 1KF						
	2.0 FSI	110	11.04	PR: 1KF						
	2.0 FSI 4x4	110	11.04	PR: 1KF						
	2.0 TDI	81	03.10	PR: 1KF						
	2.0 TDI	100	06.04	PR: 1KF						
2.0 TDI	103	06.04	PR: 1KF							
2.0 TDi 4x4	81	05.11	PR: 1KF							
2.0 TDi 4x4	103	07.06	PR: 1KF							
2.0 TDI RS	125	04.08	PR: 1KF							
2.0 RS	147	10.05	PR: 1KP	BAR12169			282 12,0 10,0			
2.0 TDI RS	125	04.06	PR: 1KP							
<b>SKODA PICK-UP (93-95)</b>										
	1.3		12.92	12.95	BA2039			20861 17,5 /S LUC		
	1.3		04.94	12.95	BAR13182			236 12,8 11,4		
	1.3		12.92	12.95	BAE5001			200 x 40 HEB VW		

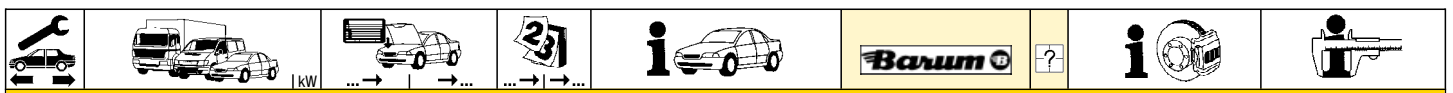

**SKODA ROOMSTER (5J) (06-)**

	1.0 i	53	07.06	PR: 1LQ,1LR,1ZG	BA2154 BA2155		23130 19,6 + 23131 19,6 +/WK	VW VW
	1.2		07.06	PR: 1LQ,1LR,1ZG				
	1.2 TDI	55	03.10	PR: 1LQ,1LR,1ZG				
	1.2 TSI	63	03.10	PR: 1LQ,1LR,1ZG				
	1.2 TSI	77	03.10	PR: 1LQ,1LR,1ZG				
	1.4	63	07.06	PR: 1LQ,1LR,1ZG				
	1.4 TDI	51	07.06	PR: 1LQ,1LR,1ZG				
	1.4 TDI	59	07.06	PR: 1LQ,1LR,1ZG				
	1.6	77	07.06	PR: 1LQ,1LR,1ZG				
	1.6 TDI	66	03.10	PR: 1LQ,1LR,1ZG				
1.6 TDI	77	03.10	PR: 1LQ,1LR,1ZG					
1.9 TDI	77	07.06	PR: 1LQ,1LR,1ZG					
	1.0 i	53	07.06	PR: 1LN	BA2298		23843 18,8 +/WK/S	LUC
	1.2		07.06	PR: 1LN				
	1.2 TDI	55	03.10	PR: 1LN				
	1.2 TSI	63	03.10	PR: 1LN				
	1.2 TSI	77	03.10	PR: 1LN				
	1.4	63	07.06	PR: 1LN				
	1.4 TDI	51	07.06	PR: 1LN				
	1.4 TDI	59	07.06	PR: 1LN				
	1.6	77	07.06	PR: 1LN				
	1.6 TDI	66	03.10	PR: 1LN				
1.6 TDI	77	03.10	PR: 1LN					
1.9 TDI	77	07.06	PR: 1LN					
	1.0 i	53	07.06	PR: 1ZC	BA2195		23587 19,6 +/WK	ATE
	1.2		07.06	PR: 1ZC				
	1.2 TDI	55	03.10	PR: 1ZC				
	1.2 TSI	63	03.10	PR: 1ZC				
	1.2 TSI	77	03.10	PR: 1ZC				
	1.4	63	07.06	PR: 1ZC				
	1.4 TDI	51	07.06	PR: 1ZC				
	1.4 TDI	59	07.06	PR: 1ZC				
	1.6	77	07.06	PR: 1ZC				
	1.6 TDI	66	03.10	PR: 1ZC				
1.6 TDI	77	03.10	PR: 1ZC					
1.9 TDI	77	07.06	PR: 1ZC					
	1.0 i	53	07.06	PR: 1LQ,1LR,1ZG	BAR22151		256 22,0 19,0 V L	
	1.2		07.06	PR: 1LQ,1LR,1ZG				
	1.2 TDI	55	03.10	PR: 1LQ,1LR,1ZG				
	1.2 TSI	63	03.10	PR: 1LQ,1LR,1ZG				
	1.2 TSI	77	03.10	PR: 1LQ,1LR,1ZG				
	1.4	63	07.06	PR: 1LQ,1LR,1ZG				
	1.4 TDI	51	07.06	PR: 1LQ,1LR,1ZG				
	1.4 TDI	59	07.06	PR: 1LQ,1LR,1ZG				
	1.6	77	07.06	PR: 1LQ,1LR,1ZG				
	1.6 TDI	66	03.10	PR: 1LQ,1LR,1ZG				
1.6 TDI	77	03.10	PR: 1LQ,1LR,1ZG					
1.9 TDI	77	07.06	PR: 1LQ,1LR,1ZG					
	1.0 i	53	07.06	PR: 1LN	BAR25113		288 25,0 22,0 V L	
	1.2		07.06	PR: 1LN				
	1.2 TDI	55	03.10	PR: 1LN				
	1.2 TSI	63	03.10	PR: 1LN				
	1.2 TSI	77	03.10	PR: 1LN				
	1.4	63	07.06	PR: 1LN				
	1.4 TDI	51	07.06	PR: 1LN				
	1.4 TDI	59	07.06	PR: 1LN				
	1.6	77	07.06	PR: 1LN				
	1.6 TDI	66	03.10	PR: 1LN				
1.6 TDI	77	03.10	PR: 1LN					
1.9 TDI	77	07.06	PR: 1LN					
	1.0 i	53	07.06	PR: 1ZC	BAR25113		288 25,0 22,0 V L	
	1.2		07.06	PR: 1ZC				
	1.2 TDI	55	03.10	PR: 1ZC				
	1.2 TSI	63	03.10	PR: 1ZC				
	1.2 TSI	77	03.10	PR: 1ZC				
	1.4	63	07.06	PR: 1ZC				
	1.4 TDI	51	07.06	PR: 1ZC				
	1.4 TDI	59	07.06	PR: 1ZC				
	1.6	77	07.06	PR: 1ZC				
	1.6 TDI	66	03.10	PR: 1ZC				
1.6 TDI	77	03.10	PR: 1ZC					
1.9 TDI	77	07.06	PR: 1ZC					
	1.0 i	53	07.06	PR: 1KK,1KT	BA2017		20961 17,2 /S	LUC
	1.2		07.06	PR: 1KK,1KT				
	1.2 TDI	55	03.10	PR: 1KK,1KT				
	1.2 TSI	63	03.10	PR: 1KK,1KT				
	1.2 TSI	77	03.10	PR: 1KK,1KT				
	1.4	63	07.06	PR: 1KK,1KT				
	1.4 TDI	51	07.06	PR: 1KK,1KT				
	1.4 TDI	59	07.06	PR: 1KK,1KT				
	1.6	77	07.06	PR: 1KK,1KT				
	1.6 TDI	66	03.10	PR: 1KK,1KT				
1.6 TDI	77	03.10	PR: 1KK,1KT					
1.9 TDI	77	07.06	PR: 1KK,1KT					





































### SKODA ROOMSTER (5J) (06-)





















	1.0 i	53		<b>07.06</b>	PR: 1KK	<b>BAR09123</b>		232 8,9 7,0
	1.2			<b>07.06</b>	PR: 1KK			
	1.2 TDI	55		<b>03.10</b>	PR: 1KK			
	1.2 TSI	63		<b>03.10</b>	PR: 1KK			
	1.2 TSI	77		<b>03.10</b>	PR: 1KK			
	1.4	63		<b>07.06</b>	PR: 1KK			
	1.4 TDI	51		<b>07.06</b>	PR: 1KK			
	1.4 TDI	59		<b>07.06</b>	PR: 1KK			
	1.6	77		<b>07.06</b>	PR: 1KK			
	1.6 TDI	66		<b>03.10</b>	PR: 1KK			
	1.6 TDI	77		<b>03.10</b>	PR: 1KK			
	1.9 TDI	77		<b>07.06</b>	PR: 1KK			
	1.0 i	53		<b>07.06</b>		<b>BAH0033</b>	2	L=140
	1.2			<b>07.06</b>				
	1.2 TDI	55		<b>03.10</b>				
	1.2 TSI	63		<b>03.10</b>				
	1.2 TSI	77		<b>03.10</b>				
	1.4	63		<b>07.06</b>				
	1.4 TDI	51		<b>07.06</b>				
	1.4 TDI	59		<b>07.06</b>				
	1.6	77		<b>07.06</b>				
	1.6 TDI	66		<b>03.10</b>				
	1.6 TDI	77		<b>03.10</b>				
	1.9 TDI	77		<b>07.06</b>				
	1.0 i	53		<b>07.06</b>	PR: 1KC	<b>BAW1905</b>		Rz 19,05
	1.2			<b>07.06</b>	PR: 1KC			
	1.2 TDI	55		<b>03.10</b>	PR: 1KC			
	1.2 TSI	63		<b>03.10</b>	PR: 1KC			
	1.2 TSI	77		<b>03.10</b>	PR: 1KC			
	1.4	63		<b>07.06</b>	PR: 1KC			
	1.4 TDI	51		<b>07.06</b>	PR: 1KC			
	1.4 TDI	59		<b>07.06</b>	PR: 1KC			
	1.6	77		<b>07.06</b>	PR: 1KC			
	1.6 TDI	66		<b>03.10</b>	PR: 1KC			
	1.6 TDI	77		<b>03.10</b>	PR: 1KC			
	1.9 TDI	77		<b>07.06</b>	PR: 1KC			
	1.0 i	53		<b>07.06</b>	PR: 1KC	<b>BAE5009</b>		230 x 32 HEB
	1.2			<b>07.06</b>	PR: 1KC			
	1.2 TDI	55		<b>03.10</b>	PR: 1KC			
	1.2 TSI	63		<b>03.10</b>	PR: 1KC			
	1.2 TSI	77		<b>03.10</b>	PR: 1KC			
	1.4	63		<b>07.06</b>	PR: 1KC			
	1.4 TDI	51		<b>07.06</b>	PR: 1KC			
	1.4 TDI	59		<b>07.06</b>	PR: 1KC			
	1.6	77		<b>07.06</b>	PR: 1KC			
	1.6 TDI	66		<b>03.10</b>	PR: 1KC			
	1.6 TDI	77		<b>03.10</b>	PR: 1KC			
	1.9 TDI	77		<b>07.06</b>	PR: 1KC			





























### SKODA SUPERB I (3U4) (02-08)

























	1.8 i 20V Turbo	110		<b>12.01</b>	<b>02.08</b>	<b>BA2172</b>		23018 20,6 +/-WK	ATE
	1.9 TDI	74		<b>08.02</b>	<b>12.07</b>				
	1.9 TDI	77		<b>10.05</b>	<b>12.07</b>				
	1.9 TDI	85		<b>01.07</b>	<b>12.07</b>				
	1.9 TDI	96		<b>12.01</b>	<b>12.07</b>				
	2.0 i	85		<b>12.01</b>	<b>02.08</b>				
	2.0 TDI	103		<b>10.05</b>	<b>12.07</b>				
	2.5 TDI	114		<b>12.01</b>	<b>12.07</b>				
	2.5 TDI	120		<b>06.03</b>	<b>12.07</b>				
	2.8 i V6	142		<b>12.01</b>	<b>12.07</b>				
	1.8 i 20V Turbo	110	3U-39046708	<b>12.01</b>		<b>BAR25105</b>		288 24,8 23,0 V L	
	1.9 TDI	74	3U-39046708	<b>08.02</b>					
	1.9 TDI	96	3U-39046708	<b>12.01</b>					
	2.0 i	85	3U-39046708	<b>12.01</b>					
	1.8 i 20V Turbo	110	3U-39046709	3U-69101369		<b>BAR25171</b>		288 25,0 23,0 V L	
	1.9 TDI	74	3U-39046709	3U-69101369					
	1.9 TDI	77	3U-39046709	3U-69101369	<b>10.05</b>				
	1.9 TDI	96	3U-39046709	3U-69101369					
	2.0 i	85	3U-39046709	3U-69101369					
	1.8 i 20V Turbo	110	3U-69101370		<b>02.08</b>	<b>BAR25145</b>		288 24,9 22,0 V L	
	1.9 TDI	74	3U-69101370		<b>12.07</b>				
	1.9 TDI	77	3U-69101370		<b>12.07</b>				
	1.9 TDI	85		<b>01.07</b>	<b>12.07</b>				
	1.9 TDI	96	3U-69101370		<b>12.07</b>				
	2.0 i	85	3U-69101370		<b>02.08</b>				
	2.0 TDI	103	3U-39043704	<b>10.05</b>		<b>BAR25137</b>		312 25,0 23,0 V L	
	2.5 TDI	114	3U-39043704	<b>12.01</b>					
	2.5 TDI	120	3U-39043704	<b>06.03</b>					
	2.8 i V6	142	3U-39043704	<b>12.01</b>		<b>BAR25137</b>		312 25,0 23,0 V L	
	2.0 TDI	103	3U-69100011		<b>12.07</b>	<b>BAR25158</b>		312 25,0 22,0 V L	
	2.5 TDI	114	3U-69100011		<b>12.07</b>				
	2.5 TDI	120	3U-69100011		<b>12.07</b>				
	2.8 i V6	142	3U-69100011		<b>12.07</b>				























								
<b>SKODA SUPERB I (3U4) (02-08)</b>								
	1.8 i 20V Turbo 1.9 TDI 1.9 TDI 1.9 TDI 1.9 TDI 2.0 i 2.0 TDI 2.5 TDI 2.5 TDI 2.8 i V6	110 74 77 85 96 85 103 114 120 142	12.01 08.02 10.05 01.07 12.01 12.01 10.05 12.01 06.03 12.01	02.08 12.07 12.07 12.07 12.07 02.08 12.07 12.07 12.07 12.07	BAH0013	2		L=295
	1.8 i 20V Turbo 1.9 TDI 1.9 TDI 1.9 TDI 1.9 TDI 2.0 i 2.0 TDI 2.5 TDI 2.5 TDI 2.8 i V6	110 74 77 85 96 85 103 114 120 142	12.01 08.02 10.05 01.07 12.01 12.01 10.05 12.01 06.03 12.01	02.08 12.07 12.07 12.07 12.07 02.08 12.07 12.07 12.07 12.07	BA2017			20961 17,2 /S LUC
	1.8 i 20V Turbo 1.9 TDI 1.9 TDI 1.9 TDI 1.9 TDI 2.0 i 2.0 TDI 2.5 TDI 2.5 TDI 2.8 i V6	110 74 77 85 96 85 103 114 120 142	12.01 08.02 10.05 01.07 12.01 12.01 10.05 12.01 06.03 12.01	02.08 12.07 12.07 12.07 12.07 02.08 12.07 12.07 12.07 12.07	BAR10201			245 9,9 8,0
<b>SKODA SUPERB II (08-)</b>								
	1.4 TSI 1.4 TSI 1.6 i 16V 1.6 TDI 1.8 TFSI 1.8 TFSI 4x4 1.9 TDI 2.0 TDI 2.0 TDI 2.0 TDI 4x4 2.0 TSI 3.6 FSI V6 4x4	92 103 77 77 77 77 77 103 125 147 191	08.08 08.08 08.08 09.10 08.08 10.08 08.08 08.08 08.08 10.08 05.10 11.08	PR: 1ZE,1LJ,1ZA PR: 1ZE,1LJ,1ZA PR: 1ZE,1LJ,1ZA PR: 1ZE,1LJ,1ZA PR: 1ZE,1LJ,1ZA PR: 1ZE,1LJ,1ZA PR: 1ZE,1LJ,1ZA PR: 1ZE,1LJ,1ZA PR: 1ZE,1LJ,1ZA PR: 1ZE,1LJ,1ZA PR: 1ZE,1LJ,1ZA	BA2195			23587 19,6 +/-WK ATE
	1.4 TSI 1.4 TSI 1.6 i 16V 1.6 TDI 1.8 TFSI 1.8 TFSI 4x4 1.9 TDI 2.0 TDI 2.0 TDI 2.0 TDI 4x4 2.0 TSI 3.6 FSI V6 4x4	92 103 77 77 77 77 77 103 125 147 191	08.08 08.08 08.08 09.10 08.08 10.08 08.08 08.08 08.08 10.08 05.10 11.08	PR: 1ZE PR: 1ZE PR: 1ZE PR: 1ZE PR: 1ZE PR: 1ZE PR: 1ZE PR: 1ZE PR: 1ZE PR: 1ZE PR: 1ZE	BAR25145			288 24,9 22,0 V L
	1.4 TSI 1.4 TSI 1.6 i 16V 1.6 TDI 1.8 TFSI 1.8 TFSI 4x4 1.9 TDI 2.0 TDI 2.0 TDI 2.0 TDI 4x4 2.0 TSI 3.6 FSI V6 4x4	92 103 77 77 77 77 77 103 125 147 191	08.08 08.08 08.08 09.10 08.08 10.08 08.08 08.08 08.08 10.08 05.10 11.08	PR: 1LJ,1ZA PR: 1LJ,1ZA PR: 1LJ,1ZA PR: 1LJ,1ZA PR: 1LJ,1ZA PR: 1LJ,1ZA PR: 1LJ,1ZA PR: 1LJ,1ZA PR: 1LJ,1ZA PR: 1LJ,1ZA PR: 1LJ,1ZA	BAR25158			312 25,0 22,0 V L
	1.4 TSI 1.4 TSI 1.6 i 16V 1.6 TDI 1.8 TFSI 1.9 TDI 2.0 TDI 2.0 TDI 2.0 TSI	92 103 77 77 77 77 103 125 147	08.08 08.08 08.08 09.10 08.08 08.08 08.08 08.08 05.10	PR: 1KF,1KJ PR: 1KF,1KJ PR: 1KF,1KJ PR: 1KF,1KJ PR: 1KF,1KJ PR: 1KF,1KJ PR: 1KF,1KJ PR: 1KF,1KJ PR: 1KF,1KJ	BA2196			23914 16,3 /WE/S LUC
	1.8 TFSI 4x4 2.0 TDI 4x4 3.6 FSI V6 4x4	191	10.08 10.08 11.08	PR: 2EA PR: 2EA PR: 2EA	BA2196			23914 16,3 /WE/S LUC
	1.4 TSI 1.4 TSI 1.6 i 16V 1.6 TDI 1.8 TFSI 1.9 TDI	92 103 77 77 77 77	08.08 08.08 08.08 09.10 08.08 08.08	PR: 1KF PR: 1KF PR: 1KF PR: 1KF PR: 1KF PR: 1KF	BAR12158			256 12,0 10,0

								
<b>SKODA SUPERB II (08-)</b>								
	2.0 TDI	103	08.08	PR: 1KF	BAR12158			256 12,0 10,0
	2.0 TDI	125	08.08	PR: 1KF				
	2.0 TSI	147	05.10	PR: 1KF				
	1.4 TSI	92	08.08	PR: 1KJ	BAR12169			282 12,0 10,0
	1.4 TSI	103	08.08	PR: 1KJ				
	1.6 i 16V	77	08.08	PR: 1KJ				
	1.6 TDI	77	09.10	PR: 1KJ				
	1.8 TFSI		08.08	PR: 1KJ				
	1.9 TDI	77	08.08	PR: 1KJ				
	2.0 TDI	103	08.08	PR: 1KJ				
	2.0 TDI	125	08.08	PR: 1KJ				
	2.0 TSI	147	05.10	PR: 1KJ				
<b>SKODA SUPERB Kombi (09-)</b>								
	1.4 TSI	92	11.09	PR: 1LJ,1ZA,1ZE	BA2195			23587 19,6 +/-WK ATE
	1.6 TDI	77	09.10	PR: 1LJ,1ZA,1ZE				
	1.8 TSI		11.09	PR: 1LJ,1ZA,1ZE				
	1.8 TSI 4x4		11.09	PR: 1LJ,1ZA,1ZE				
	2.0 TDI	103	11.09	PR: 1LJ,1ZA,1ZE				
	2.0 TDI	125	11.09	PR: 1LJ,1ZA,1ZE				
	2.0 TDI 4x4	125	11.09	PR: 1LJ,1ZA,1ZE				
	2.0 TSI	147	05.10	PR: 1LJ,1ZA,1ZE				
	3.6 V6 4x4	191	11.09	PR: 1LJ,1ZA,1ZE				
	1.4 TSI	92	11.09	PR: 1ZE	BAR25145			288 24,9 22,0 V L
	1.6 TDI	77	09.10	PR: 1ZE				
	1.8 TSI		11.09	PR: 1ZE				
	1.8 TSI 4x4		11.09	PR: 1ZE				
	2.0 TDI	103	11.09	PR: 1ZE				
	2.0 TDI	125	11.09	PR: 1ZE				
	2.0 TDI 4x4	125	11.09	PR: 1ZE				
	2.0 TSI	147	05.10	PR: 1ZE				
	3.6 V6 4x4	191	11.09	PR: 1ZE				
	1.4 TSI	92	11.09	PR: 1LJ,1ZA	BAR25158			312 25,0 22,0 V L
	1.6 TDI	77	09.10	PR: 1LJ,1ZA				
	1.8 TSI		11.09	PR: 1LJ,1ZA				
	1.8 TSI 4x4		11.09	PR: 1LJ,1ZA				
	2.0 TDI	103	11.09	PR: 1LJ,1ZA				
	2.0 TDI	125	11.09	PR: 1LJ,1ZA				
	2.0 TDI 4x4	125	11.09	PR: 1LJ,1ZA				
	2.0 TSI	147	05.10	PR: 1LJ,1ZA				
	3.6 V6 4x4	191	11.09	PR: 1LJ,1ZA				
	1.4 TSI	92	11.09	PR: 1KF,1KJ	BA2196			23914 16,3 /WE/S LUC
	1.6 TDI	77	09.10	PR: 1KF,1KJ				
	1.8 TSI		11.09	PR: 1KF,1KJ				
	2.0 TDI	103	11.09	PR: 1KF,1KJ				
	2.0 TDI	125	11.09	PR: 1KF,1KJ				
	2.0 TSI	147	05.10	PR: 1KF,1KJ				
	1.8 TSI 4x4		11.09	PR: 2EA	BA2196			23914 16,3 /WE/S LUC
	2.0 TDI 4x4	125	11.09	PR: 2EA				
	3.6 V6 4x4	191	11.09	PR: 2EA				
	1.4 TSI	92	11.09	PR: 1KF	BAR12158			256 12,0 10,0
	1.6 TDI	77	09.10	PR: 1KF				
	1.8 TSI		11.09	PR: 1KF				
	2.0 TDI	103	11.09	PR: 1KF				
	2.0 TDI	125	11.09	PR: 1KF				
	2.0 TSI	147	05.10	PR: 1KF				
	1.4 TSI	92	11.09	PR: 1KJ	BAR12169			282 12,0 10,0
	1.6 TDI	77	09.10	PR: 1KJ				
	1.8 TSI		11.09	PR: 1KJ				
	2.0 TDI	103	11.09	PR: 1KJ				
	2.0 TDI	125	11.09	PR: 1KJ				
	2.0 TSI	147	05.10	PR: 1KJ				
<b>SKODA YETI (09-)</b>								
	1.2 TSI	77	09.09	PR: 1ZF	BA2155			23131 19,6 +/-WK VW
	1.4 TSI	90	06.10	PR: 1ZF				
	1.6 TDI	77	11.10	PR: 1ZF				
	1.8 TSI 4x4		05.09	PR: 1ZF				
	2.0 TDI	81	11.09	PR: 1ZF				
	2.0 TDI 4x4	81	11.09	PR: 1ZF				
	2.0 TDI 4x4	103	05.09	PR: 1ZF				
	2.0 TDI 4x4	125	11.09	PR: 1ZF				
	1.2 TSI	77	09.09	PR: 1ZA,1ZE	BA2195			23587 19,6 +/-WK ATE
	1.4 TSI	90	06.10	PR: 1ZA,1ZE				
	1.6 TDI	77	11.10	PR: 1ZA,1ZE				
	1.8 TSI 4x4		05.09	PR: 1ZA,1ZE				
	2.0 TDI	81	11.09	PR: 1ZA,1ZE				
	2.0 TDI 4x4	81	11.09	PR: 1ZA,1ZE				
	2.0 TDI 4x4	103	05.09	PR: 1ZA,1ZE				
	2.0 TDI 4x4	125	11.09	PR: 1ZA,1ZE				
	1.2 TSI	77	09.09	PR: 1ZF	BAR22210			280 22,0 19,0 V L
	1.4 TSI	90	06.10	PR: 1ZF				
	1.6 TDI	77	11.10	PR: 1ZF				
	1.8 TSI 4x4		05.09	PR: 1ZF				
	2.0 TDI	81	11.09	PR: 1ZF				
	2.0 TDI 4x4	81	11.09	PR: 1ZF				

								
<b>SKODA YETI (09-)</b>								
	2.0 TDI 4x4	103		<b>05.09</b>	PR: 1ZF	<b>BAR22210</b>		280 22,0 19,0 V L
	2.0 TDI 4x4	125		<b>11.09</b>	PR: 1ZF			
	1.2 TSI	77		<b>09.09</b>	PR: 1ZE	<b>BAR25145</b>		288 24,9 22,0 V L
	1.4 TSI	90		<b>06.10</b>	PR: 1ZE			
	1.6 TDI	77		<b>11.10</b>	PR: 1ZE			
	1.8 TSI 4x4			<b>05.09</b>	PR: 1ZE			
	2.0 TDI	81		<b>11.09</b>	PR: 1ZE			
	2.0 TDI 4x4	81		<b>11.09</b>	PR: 1ZE			
	2.0 TDI 4x4	103		<b>05.09</b>	PR: 1ZE			
	2.0 TDI 4x4	125		<b>11.09</b>	PR: 1ZE			
	1.2 TSI	77		<b>09.09</b>	PR: 1ZA			
	1.4 TSI	90		<b>06.10</b>	PR: 1ZA			
1.6 TDI	77		<b>11.10</b>	PR: 1ZA				
1.8 TSI 4x4			<b>05.09</b>	PR: 1ZA				
2.0 TDI	81		<b>11.09</b>	PR: 1ZA				
2.0 TDI 4x4	81		<b>11.09</b>	PR: 1ZA				
2.0 TDI 4x4	103		<b>05.09</b>	PR: 1ZA				
2.0 TDI 4x4	125		<b>11.09</b>	PR: 1ZA				
	1.2 TSI	77		<b>09.09</b>	PR: 1KD	<b>BA2017</b>		20961 17,2 /S <b>LUC</b>
	1.4 TSI	90		<b>06.10</b>	PR: 1KD			
	1.6 TDI	77		<b>11.10</b>	PR: 1KD			
	2.0 TDI	81		<b>11.09</b>	PR: 1KD			
	1.2 TSI	77		<b>09.09</b>	PR: 1KJ	<b>BA2196</b>		23914 16,3 /WE/S <b>LUC</b>
	1.4 TSI	90		<b>06.10</b>	PR: 1KJ			
	1.6 TDI	77		<b>11.10</b>	PR: 1KJ			
	1.8 TSI 4x4			<b>05.09</b>	PR: 1KJ			
	2.0 TDI	81		<b>11.09</b>	PR: 1KJ			
	2.0 TDI 4x4	81		<b>11.09</b>	PR: 1KJ			
	2.0 TDI 4x4	103		<b>05.09</b>	PR: 1KJ			
	2.0 TDI 4x4	125		<b>11.09</b>	PR: 1KJ			
	1.2 TSI	77		<b>09.09</b>	PR: 1KJ	<b>BAR12169</b>		282 12,0 10,0
	1.4 TSI	90		<b>06.10</b>	PR: 1KJ			
	1.6 TDI	77		<b>11.10</b>	PR: 1KJ			
	1.8 TSI 4x4			<b>05.09</b>	PR: 1KJ			
	2.0 TDI	81		<b>11.09</b>	PR: 1KJ			
	2.0 TDI 4x4	81		<b>11.09</b>	PR: 1KJ			
	2.0 TDI 4x4	103		<b>05.09</b>	PR: 1KJ			
2.0 TDI 4x4	125		<b>11.09</b>	PR: 1KJ				
<b>SMART CABRIO (BM450) (00-03)</b>								
	0.6	40		<b>03.00</b>	<b>01.04</b>	<b>BA2217</b>		21999 15,5 +/-WK <b>BOS</b>
	0.6	45		<b>01.01</b>	<b>01.04</b>			
	0.6	52		<b>06.02</b>	<b>01.04</b>			
	0.7	45		<b>01.03</b>	<b>01.04</b>			
	0.7	55		<b>01.03</b>	<b>01.04</b>			
	0.8 CDI	30		<b>03.01</b>	<b>01.04</b>			
	0.6	40		<b>03.00</b>	<b>01.04</b>	<b>BAR09136</b>		280 9,0 8,0 L
	0.6	45		<b>01.01</b>	<b>01.04</b>			
	0.6	52		<b>06.02</b>	<b>01.04</b>			
	0.7	45		<b>01.03</b>	<b>01.04</b>			
	0.7	55		<b>01.03</b>	<b>01.04</b>			
	0.8 CDI	30		<b>03.01</b>	<b>01.04</b>			
	0.6	40		<b>03.00</b>	<b>01.04</b>	<b>BAW2204</b> <b>BAW2206</b>		Rz 22,20 <b>BOS</b> Rz 22,20 <b>BOS</b>
	0.6	45		<b>01.01</b>	<b>01.04</b>			
	0.6	52		<b>06.02</b>	<b>01.04</b>			
	0.7	45		<b>01.03</b>	<b>01.04</b>			
	0.7	55		<b>01.03</b>	<b>01.04</b>			
	0.8 CDI	30		<b>03.01</b>	<b>01.04</b>			
	0.6	40		<b>03.00</b>	<b>01.04</b>	<b>BAE5040</b>		203 x 32 HEB <b>BOS</b>
	0.6	45		<b>01.01</b>	<b>01.04</b>			
	0.6	52		<b>06.02</b>	<b>01.04</b>			
	0.7	45		<b>01.03</b>	<b>01.04</b>			
	0.7	55		<b>01.03</b>	<b>01.04</b>			
	0.8 CDI	30		<b>03.01</b>	<b>01.04</b>			
<b>SMART CITY COUPE (BM450) (98-04)</b>								
	0.6	33		<b>07.98</b>	<b>01.04</b>	<b>BA2217</b>		21999 15,5 +/-WK <b>BOS</b>
	0.6	40		<b>07.98</b>	<b>01.04</b>			
	0.6	45		<b>01.01</b>	<b>01.04</b>			
	0.6	52		<b>06.02</b>	<b>01.04</b>			
	0.7	37		<b>01.03</b>	<b>01.04</b>			
	0.7	45		<b>01.03</b>	<b>01.04</b>			
	0.7	55		<b>01.03</b>	<b>01.04</b>			
	0.8 CDI	30		<b>11.99</b>	<b>01.04</b>			
		0.6	33		<b>07.98</b>			
0.6		40		<b>07.98</b>	<b>01.04</b>			
0.6		45		<b>01.01</b>	<b>01.04</b>			
0.6		52		<b>06.02</b>	<b>01.04</b>			
0.7		37		<b>01.03</b>	<b>01.04</b>			
0.7		45		<b>01.03</b>	<b>01.04</b>			
0.7		55		<b>01.03</b>	<b>01.04</b>			
0.8 CDI		30		<b>11.99</b>	<b>01.04</b>			

























									
<b>SMART CITY COUPE (BM450) (98-04)</b>									
	0.6	33	11.99	01.04	+ ESP	BAW2204		Rz 22,20	<b>BOS</b>
	0.6	40	11.99	01.04	+ ESP	BAW2206		Rz 22,20	<b>BOS</b>
	0.6	45	01.01	01.04	+ ESP				
	0.6	52	06.02	01.04	+ ESP				
	0.7	37	01.03	01.04	+ ESP				
	0.7	45	01.03	01.04	+ ESP				
	0.7	55	01.03	01.04	+ ESP				
	0.8 CDI	30	11.99	01.04	+ ESP				
	0.6	33	07.98	01.04		BAE5040		203 x 32 HEB	<b>BOS</b>
	0.6	40	07.98	01.04					
	0.6	45	01.01	01.04					
	0.6	52	06.02	01.04					
	0.7	37	01.03	01.04					
	0.7	45	01.03	01.04					
	0.7	55	01.03	01.04					
	0.8 CDI	30	11.99	01.04					
<b>SMART CROSSBLADE (BM450) (02-04)</b>									
	0.6	52	06.02	01.04		BA2217		21999 15,5 +/WK	<b>BOS</b>
	0.6	52	06.02	01.04	- Ⓢ	BAR09136		280 9,0 8,0 L	
	0.6	52	06.02	01.04		BAW2204 BAW2206		Rz 22,20 Rz 22,20	<b>BOS</b> <b>BOS</b>
	0.6	52	06.02	01.04		BAE5040	- ESP	203 x 32 HEB	<b>BOS</b>
<b>SMART FORFOUR (BM454) (04-06)</b>									
	1.1		03.04	12.06		BA2268		21920 15,1 /WK/S	<b>LUC</b>
	1.3	70	03.04	12.06					
	1.5	80	03.04	12.06					
	1.5	90	11.04	12.06					
	1.5 CDI	50	08.04	12.06					
	1.5 CDI	70	08.04	12.06					
	1.5 BRABUS	130	02.05	12.06		BA2237		21983 17,3 /WK/Zub	<b>LUC</b>
	1.1		03.04	12.06		BAR24192		256 24,0 21,5 V	
	1.3	70	03.04	12.06					
	1.5	80	03.04	12.06					
	1.5	90	11.04	12.06					
	1.5 CDI	50	08.04	12.06					
	1.5 CDI	70	08.04	12.06					
	1.1		03.04	12.06		BA2226		21861 15,3 /WK/S	<b>LUC</b>
	1.3	70	03.04	12.06					
	1.5	80	03.04	12.06					
	1.5	90	11.04	12.06					
	1.5 BRABUS	130	02.05	12.06					
	1.5 CDI	50	08.04	12.06					
	1.5 CDI	70	08.04	12.06					
	1.1		03.04	12.06		BAR10304		250 10,0 8,0	
	1.3	70	03.04	12.06					
	1.5	80	03.04	12.06					
	1.5	90	11.04	12.06					
	1.5 BRABUS	130	02.05	12.06					
	1.5 CDI	50	08.04	12.06					
	1.5 CDI	70	08.04	12.06					
<b>SMART FORTWO CABRIO (BM450) (04-07)</b>									
	0.7	45	01.04	04.07		BA2217		21999 15,5 +/WK	<b>BOS</b>
	0.7 BRABUS	55	01.04	04.07					
	0.8 CDI	30	01.04	04.07					
	0.7	45	01.04	04.07		BAR09136		280 9,0 8,0 L	
	0.7 BRABUS	55	01.04	04.07					
	0.8 CDI	30	01.04	04.07					
	0.7	45	01.04	04.07		BAW2204 BAW2206		Rz 22,20 Rz 22,20	<b>BOS</b> <b>BOS</b>
	0.7 BRABUS	55	01.04	04.07					
	0.8 CDI	30	01.04	04.07					
	0.7	45	01.04	04.07		BAE5040		203 x 32 HEB	<b>BOS</b>
	0.7 BRABUS	55	01.04	04.07					
	0.8 CDI	30	01.04	04.07					
<b>SMART FORTWO COUPE (BM450) (04-07)</b>									
	0.7	37	01.04	04.07		BA2217		21999 15,5 +/WK	<b>BOS</b>
	0.7	45	01.04	04.07					
	0.7 BRABUS	55	01.04	04.07					
	0.8 CDI	30	01.04	04.07					
	0.7	37	01.04	04.07		BAR09136		280 9,0 8,0 L	
	0.7	45	01.04	04.07					
	0.7 BRABUS	55	01.04	04.07					
	0.8 CDI	30	01.04	04.07					

									
<b>SMART FORTWO COUPE (BM450) (04-07)</b>									
	0.7 0.7 BRABUS 0.8 CDI	37 45 55 30	01.04 01.04 01.04 01.04	04.07 04.07 04.07 04.07	BAW2204 BAW2206			Rz 22,20 Rz 22,20	BOS BOS
	0.7 0.7 BRABUS 0.8 CDI	37 45 55 30	01.04 01.04 01.04 01.04	04.07 04.07 04.07 04.07	BAE5040			203 x 32 HEB	BOS
<b>SMART FORTWO CABRIO (BM451) (07-)</b>									
	0.8 CDI 0.8 CDi 1.0 1.0 BRABUS 1.0 MHD Hybrid 1.0 Turbo Electric Drive Electric Drive	33 40 52 71 71 62 20 55	04.07 08.09 04.07 07.07 10.07 04.07 12.10 04.12		BA2217			21999 15,5 +/WK	BOS
<b>SMART FORTWO COUPE (BM451) (07-)</b>									
	0.8 CDI 0.8 CDi 1.0 1.0 1.0 BRABUS 1.0 MHD Hybrid 1.0 Turbo Electric Drive Electric Drive	33 40 45 52 72 71 62 20 55	04.07 08.09 04.07 04.07 07.07 10.07 04.07 12.10 04.12		BA2217			21999 15,5 +/WK	BOS
<b>SMART ROADSTER (BM452) (03-05)</b>									
	0.7 0.7 0.7 BRABUS	45 60 74	04.03 04.03 03.04	12.05 12.05 12.05	BA2217			21999 15,5 +/WK	BOS
	0.7 0.7 0.7 BRABUS	45 60 74	04.03 04.03 03.04	12.05 12.05 12.05	BAR09136			280 9,0 8,0 L	
	0.7 0.7 0.7 BRABUS	45 60 74	04.03 04.03 03.04	12.05 12.05 12.05	BAE5040			203 x 32 HEB	BOS
<b>SMART ROADSTER COUPE (BM452) (03-05)</b>									
	0.7 0.7 0.7 BRABUS	45 60 74	04.05 04.03 03.04	12.05 12.05 12.05	BA2217			21999 15,5 +/WK	BOS
	0.7 0.7 0.7 BRABUS	45 60 74	04.05 04.03 03.04	12.05 12.05 12.05	BAR09136			280 9,0 8,0 L	
	0.7 0.7 0.7 BRABUS	45 60 74	04.05 04.03 03.04	12.05 12.05 12.05	BAE5040			203 x 32 HEB	BOS
<b>SUBARU JUSTY (G3X) (03-07)</b>									
	1.3 i 16V 1.3 i 16V 4WD 1.5 i 16V 4WD	66 69 73	09.03 09.03 09.03	08.07 08.07 08.07	BA2260			23253 15,9 +/WK/S	BOS
<b>SUZUKI IGNIS II (03-)</b>									
	1.3 DDiS 1.3 i 16V 1.3 i 16V 4x4 1.5 i 16V 1.5 i 16V 4x4	51 69 69 73 73	09.03 09.03 09.03 09.03 09.03		BA2260			23253 15,9 +/WK/S	BOS
<b>SUZUKI SPLASH (08-)</b>									
	1.0 i 12V 1.2 i 16V 1.3 CDTi	48 63 55	01.08 01.08 01.08		BA2301			23973 17,3 +/WK/S	LUC
<b>SUZUKI SWIFT III (05-)</b>									
	1.3 16V 1.3 16V 4x4 1.3 16V 4x4 1.3 DDiS 1.3 DDiS 1.5 16V 4x4 1.5 VVTi 1.6 VVTi	68 66 68 51 55 74 75 92	02.05 01.06 02.05 08.05 08.05 02.05 02.05 05.06	09.07	BA2301			23973 17,3 +/WK/S	LUC
	1.6 VVTi	92	05.06		BA2280			21719 15,0 +/WK	AKE

								
<b>SUZUKI SX4 (06-)</b>								
	1.5 i 16V	73	06.06		BA2280		+ ABS	21719 15,0 +/WK AKE
	1.5 VVT	82	07.10					
	1.6 DDiS	66	04.07					
	1.6 i 16V	88	10.07					
	1.6 i 16V 4x4	88	07.09					
	1.6 VVT	79	06.06					
	1.6 VVT 4x4	79	06.06					
	1.9 DDiS	88	06.06					
	1.9 DDiS 4x4	88	06.06					
	2.0 DDiS	99	07.09					
	2.0 DDiS 4x4	99	07.09					
	2.0 i 16V	107	06.06					
	2.0 i 16V 4x4	107	06.06					
<b>SUZUKI WAGON R+ (00-)</b>								
	1.0 i 12V	44	06.04		BA2260			23253 15,9 +/WK/S BOS
	1.2 i 16V	59	06.04					
	1.3 DDiS	51	09.03	04.08				
	1.3 i 16V	56	05.00	08.03				
	1.3 i 16V	65	08.01					
	1.3 i 16V	69	09.03					
	1.3 i 16V 4WD	56	10.01	08.03				
	1.3 i 16V 4WD	69	09.03					
	1.3 VVTi 4WD	69	09.03					
<b>TOYOTA AVENSIS (03-09)</b>								
	1.6 i 16V	81	04.03	01.09	BA2295			23768 18,8 +/WK BOS
	1.8 i 16V	95	04.03	01.09				
	2.0 D-4D	85	04.03	04.06				
	2.0 D-4D	93	03.06	01.09				
	2.0 i 16V	108	04.03	01.09				
	2.2 D-4D	110	10.05	01.09				
	2.2 D-CAT	130	07.05	01.09				
	2.4 i 16V	120	10.03	01.09				
	2.4 i 16V	125	09.03	01.09				
	2.2 D-4D	110	10.05	01.09	BAR26138			295 26,0 24,0 V
	2.2 D-CAT	130	07.05	01.09				
	1.6 i 16V	81	04.03	01.09	BA2326			23620 16,7 +/WK BOS
	1.8 i 16V	95	04.03	01.09				
	2.0 D-4D	85	04.03	04.06				
	2.0 D-4D	93	03.06	01.09				
	2.0 i 16V	108	04.03	01.09				
	2.2 D-4D	110	10.05	01.09				
	2.2 D-CAT	130	07.05	01.09				
	2.4 i 16V	120	10.03	01.09				
	2.4 i 16V	125	09.03	01.09				
<b>TOYOTA AYGO (05-)</b>								
	1.0 i 12V	50	07.05		BA2296			23959 17,6 /S BOS
	1.0 i 12V GPL	50	07.05					
	1.4 HDi	40	07.05					
<b>TOYOTA CARINA II (87-92)</b>								
	1.6 (AT171)		12.87	01.92 + 13" Rad 1)	BA2121			20870 15,0 AKE
	2.0 (ST171)		12.87	01.92 + 13" Rad 1)				
	2.0 D (CT170)		12.87	01.92				
	1.6 (AT171)		12.87	01.92	BAE5035			200 x 37
	2.0 (ST171)		12.87	01.92				
	2.0 D (CT170)		12.87	01.92				
<b>TOYOTA CARINA E (92-97)</b>								
	1.6 i (AT190)		02.92	09.97	BA2116			21601 17,5 +/WK SUM
	1.8 i (AT191)		02.92	09.97				
	2.0 D (CT190)		02.92	09.97				
	2.0 i (ST191)		02.92	09.97				
	1.6 i (AT190)		02.92	09.97	BAR25124			255 24,9 24,0 V
	2.0 D (CT190)		02.92	09.97				
	1.6 i (AT190)		02.92	12.95 + Hosei Bremse 2)	BAE5035			200 x 37
	1.8 i (AT191)		02.92	12.95 + Hosei Bremse 2)				
	2.0 D (CT190)		02.92	12.95 + Hosei Bremse 2)				
	2.0 i (ST191)		02.92	12.95 + Hosei Bremse 2)				
<b>TOYOTA CELICA (89-93)</b>								
	1.6 i (AT180)	77	10.89	11.93	BA2121			20870 15,0 AKE
	1.6 i (AT180)	77	10.89	11.93	BAE5035			200 x 37

1) + 13" wheel / + ruota 13" / + roue 13" / + rueda 13"

2) + Hosei brake / + freno Hosei / + freins Hosei / + freno de Hosei

								
<b>TOYOTA CELICA (93-99)</b>								
	1.8 i (AT200)		11.93	11.99		BA2116		21601 17,5 +/WK SUM
	1.8 i (AT200)		11.93	11.99		BAR25124		255 24,9 24,0 V
<b>TOYOTA CELICA (99-05)</b>								
	1.8 VVTi (ZZT230)	105	11.99	07.02		BA2294		23510 16,5 +/WK AKE
	1.8 VVTi (ZZT230)	105	11.99	07.02		BAR25124		255 24,9 24,0 V
	1.8 VVTi (ZZT230) 1.8 VVTi TS (ZZT231)	105 141	11.99 11.99	09.05 09.05		BA2293		23521 14,0 +/WK SUM
<b>TOYOTA COROLLA (87-92)</b>								
	1.3 (EE90) 1.6 (AE92) 1.6 4WD (AE95) 1.8 D (CE90)		05.87 05.87 05.87 05.87	05.92 05.92 05.92 05.92		BA2121		20870 15,0 AKE
	1.3 (EE90) 1.6 (AE92) 1.8 D (CE90)		05.87 05.87 05.87	05.92 + Kombiwagen <sup>1)</sup> 05.92 + Kombiwagen <sup>1)</sup> 05.92 + Kombiwagen <sup>1)</sup>		BAE5035		200 x 37
<b>TOYOTA COROLLA (92-97)</b>								
	1.3 16V (EE101) 1.6 (AE101) 1.8 (AE102) 1.8 (AE103) 2.0 D (CE100)		05.92 05.92 05.92 05.95 05.92	04.97 + Europa <sup>2)</sup> 04.97 + Europa <sup>2)</sup> 05.95 + Europa <sup>2)</sup> 04.97 + Europa/ + Kombiwagen <sup>3)</sup> 04.97 + Europa/ - GUS-Staaten <sup>4)</sup>		BA2116		21601 17,5 +/WK SUM
	1.3 (EE100) 1.3 (EE105) 1.3 16V (EE101) 1.5 (AE100) 1.5 (EE104) 1.5 (EE108) 1.6 (AE101) 1.6 GT APEX (AE101) 1.8 (AE102) 2.0 D (CE100)		05.92 05.92 05.92 05.92 05.92 05.92 05.92 05.92 05.92 05.92	05.95 - Europa <sup>5)</sup> 04.97 - Europa <sup>5)</sup> 04.97 - Europa <sup>5)</sup> 04.97 - Europa <sup>5)</sup> 04.97 - Europa <sup>5)</sup> 04.97 - Europa <sup>5)</sup> 04.97 - Europa <sup>5)</sup> 05.95 - Europa/ + Coupe <sup>6)</sup> 05.95 - Europa <sup>5)</sup> 04.97 - Europa/ + GUS-Staaten <sup>7)</sup>		BA2121		20870 15,0 AKE
	1.3 16V (EE101) 1.6 (AE101) 1.8 (AE102) 1.8 (AE103) 2.0 D (CE100)		05.92 05.92 05.92 05.95 05.92	04.97 + Europa <sup>2)</sup> 04.97 + Europa <sup>2)</sup> 05.95 + Europa <sup>2)</sup> 04.97 + Europa/ + Kombiwagen <sup>3)</sup> 04.97 + Europa/ - GUS-Staaten <sup>4)</sup>		BAR22158		255 22,0 20,0 V
	1.3 (EE100) 1.3 (EE105) 1.3 16V (EE101) 1.5 (AE100) 1.5 (EE104) 1.5 (EE108) 1.6 (AE101) 1.8 (AE102) 1.8 (AE103) 2.0 D (CE100)		05.92 05.92 05.92 05.92 05.92 05.92 05.92 05.92 05.95 05.92	05.95 - Europa <sup>5)</sup> 04.97 - Europa <sup>5)</sup> 04.97 - Europa <sup>5)</sup> 04.97 - Europa <sup>5)</sup> 04.97 - Europa <sup>5)</sup> 04.97 - Europa <sup>5)</sup> 04.97 - Europa <sup>5)</sup> 04.97 - Europa <sup>5)</sup> 05.95 - Europa/ + Kombiwagen <sup>8)</sup> 04.97 - Europa <sup>5)</sup>		BAE5035		200 x 37
<b>TOYOTA COROLLA (97-02)</b>								
	1.4 i (EE111) 1.4 i 16V (ZZE111) 1.6 i (AE111) 1.6 i 16V (ZZE112)	63 71 81 81	05.97 02.00 05.97 02.00	01.00 + Schlechtwegeausführung <sup>9)</sup> 12.01 + Schlechtwegeausführung <sup>9)</sup> 01.00 + Schlechtwegeausführung <sup>9)</sup> 12.01 + Schlechtwegeausführung <sup>9)</sup>		BA2121		20870 15,0 AKE
	1.4 i (EE111) 1.4 i 16V (ZZE111) 1.6 i (AE111) 1.6 i 16V (ZZE112) 1.8 i 16V AWD (AE115) 1.9 D (WZE110) 2.0 D (CE110) 2.0 D-4D (CDE110)	63 71 81 81 81 51 53 66	05.97 02.00 05.97 02.00 05.97 02.00 05.97 09.00	01.00 - Schlechtwegeausführung <sup>10)</sup> 12.01 - Schlechtwegeausführung <sup>10)</sup> 01.00 - Schlechtwegeausführung <sup>10)</sup> 12.01 - Schlechtwegeausführung <sup>10)</sup> 12.01 + Kombiwagen <sup>1)</sup> 12.01 01.00 12.01		BA2116		21601 17,5 +/WK SUM
	1.4 i (EE111) 1.4 i 16V (ZZE111) 1.6 i (AE111) 1.6 i 16V (ZZE112) 1.8 i 16V AWD (AE115) 1.9 D (WZE110) 2.0 D (CE110) 2.0 D-4D (CDE110)	63 71 81 81 81 51 53 66	05.97 02.00 05.97 02.00 05.97 02.00 05.97 09.00	01.00 - Schlechtwegeausführung <sup>10)</sup> 12.01 - Schlechtwegeausführung <sup>10)</sup> 01.00 - Schlechtwegeausführung <sup>10)</sup> 12.01 - Schlechtwegeausführung <sup>10)</sup> 12.01 + Kombiwagen <sup>1)</sup> 12.01 01.00 12.01		BAR22158		255 22,0 20,0 V
	1.4 i (EE111) 1.4 i 16V (ZZE111) 1.6 i (AE111) 1.6 i 16V (ZZE112) 1.8 i 16V AWD (AE115)	63 71 81 81 81	05.97 02.00 05.97 02.00 05.97	01.00 12.01 01.00 12.01 12.01 + Kombiwagen <sup>1)</sup>		BAE5035		200 x 37

1) + estate / + Station Wagon / + break / + break

2) + Europe / + Europa / + Europe / + Europa

3) + Europe/ + Estate / + Europa/ + Station Wagon / + Europe/ + Break / + Europa/ + Break

4) + Europe/ - GUS States / + Europa/ - Stati del GUS / + Europe/ - Etats de la CEI / + Europa/ - estados del GUS

5) - Europe / - Europa / - Europe / - Europa

6) - Europe/ + Coupe / - Europa/ + Coupé / - Europe/ + Coupé / - Europa/ + Coupé













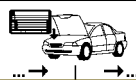















7) - Europe/ + GUS-States / - Europa/ + Stati del GUS / - Europe/ + Etats de la CEI / - Europa/ + estados del GUS





8) - Europe/ + Estate / - Europa/ + Station Wagon / - Europe/ + Break / - Europa/ + Break

9) + rough road construction / + versione per percorsi accidentati / + version pour mauvaise route / + versión 4x4



























10) - rough road construction / - versione per percorsi accidentati / - version pour mauvaise route / - versión 4x4



								
<b>TOYOTA COROLLA (97-02)</b>								
	1.9 D (WZE110) 2.0 D (CE110)	51 53		02.00 05.97	12.01 01.00		BAE5035	200 x 37
<b>TOYOTA COROLLA (02-04)</b>								
	1.4 VVTi (ZZE120) 1.6 VVTi (ZZE121)	71 81		01.02 01.02	05.04 05.04		BA2294	Herst.Land <sup>1)</sup> 23510 16,5 +/WK AKE
	1.4 VVTi (ZZE120) 1.6 VVTi (ZZE121) 1.8 VVTi TS (ZZE123) 2.0 D-4D (CDE120) 2.0 D-4D (CDE120) 2.0 D-4D (CDE120)	71 81 141 66 81 85		02.02 08.02 01.02 08.02 01.02 05.03	05.04 05.04 05.04 05.04 05.04 05.04		BA2270	23766 18,0 +/WK LUC
	1.4 VVTi (ZZE120) 1.6 VVTi (ZZE121) 2.0 D-4D (CDE120)	71 81 66		01.02 01.02 01.02	05.04 05.04 05.04		BA2293	Herst.Land <sup>1)</sup> 23521 14,0 +/WK SUM
	1.4 VVTi (ZZE120) 1.6 VVTi (ZZE121) 1.8 VVTi TS (ZZE123) 2.0 D-4D (CDE120) 2.0 D-4D (CDE120) 2.0 D-4D (CDE120)	71 81 141 66 81 85		02.02 08.02 01.02 08.02 01.02 05.03	05.04 05.04 05.04 05.04 05.04 05.04		BA2331	Herst.Land <sup>2)</sup> 23816 16,1 /WK LUC
	1.4 VVTi (ZZE120) 1.6 VVTi (ZZE121) 2.0 D-4D (CDE120)	71 81 66		01.02 01.02 01.02	05.04 05.04 05.04		BAR09139	269 9,0 8,0
	1.4 VVTi (ZZE120) 1.6 VVTi (ZZE121)	71 81		02.02 08.02	05.04 05.04		BAR09138	258 9,0 8,0
<b>TOYOTA COROLLA (04-06)</b>								
	1.4 D-4D (NDE120) 1.4 VVTi (ZZE120) 1.6 VVTi (ZZE121) 1.8 VVTi (ZZE123) 2.0 D-4D (CDE120)	66 71 81 141 85		06.04 06.04 06.04 06.04 06.04	10.06 10.06 10.06 10.06 10.06		BA2270	23766 18,0 +/WK LUC
	1.4 D-4D (NDE120) 1.4 VVTi (ZZE120) 1.6 VVTi (ZZE121) 1.8 VVTi (ZZE123) 2.0 D-4D (CDE120)	66 71 81 141 85		06.04 06.04 06.04 06.04 06.04	10.06 10.06 10.06 10.06 10.06		BA2331	23816 16,1 /WK LUC
	1.4 VVTi (ZZE120) 1.6 VVTi (ZZE121) 1.8 VVTi (ZZE123)	71 81 141		06.04 06.04 06.04	10.06 10.06 10.06		BAR09138	258 9,0 8,0
	1.4 VVTi (ZZE120) 1.6 VVTi (ZZE121) 1.8 VVTi (ZZE123)	71 81 141		06.04 06.04 06.04	10.06 10.06 10.06		BAR09138	258 9,0 8,0
<b>TOYOTA COROLLA VERSO (02-04)</b>								
	1.4 VVTi (ZZE120) 1.6 VVTi (ZZE121)	71 81		01.02 01.02	05.04 05.04		BA2294	23510 16,5 +/WK AKE
	1.4 VVTi (ZZE120) 1.6 VVTi (ZZE121) 1.8 VVTi (ZZE122) 2.0 D-4D (CDE120)	71 81 99 66		01.02 01.02 01.02 01.02	05.04 05.04 05.04 05.04		BA2293	23521 14,0 +/WK SUM
	1.4 VVTi (ZZE120) 1.6 VVTi (ZZE121) 1.8 VVTi (ZZE122) 2.0 D-4D (CDE120)	71 81 99 66		01.02 01.02 01.02 01.02	05.04 05.04 05.04 05.04		BAR09139	269 9,0 8,0
<b>TOYOTA COROLLA VERSO (04-)</b>								
	1.6 VVTi (ZNR10) 1.8 VVTi (ZNR11) 2.0 D-4D (CUR10) 2.2 D-4D (AUR10) 2.2 D-4D (AUR10)	81 95 85 100 130		05.04 05.04 05.04 09.05 09.05	08.05		BA2295	23768 18,8 +/WK BOS
	1.6 VVTi (ZNR10) 1.8 VVTi (ZNR11) 2.0 D-4D (CUR10) 2.2 D-4D (AUR10) 2.2 D-4D (AUR10)	81 95 85 100 130		05.04 05.04 05.04 09.05 09.05	08.05		BAR26138	295 26,0 24,0 V
	1.6 VVTi (ZNR10) 1.8 VVTi (ZNR11) 2.0 D-4D (CUR10) 2.2 D-4D (AUR10) 2.2 D-4D (AUR10)	81 95 85 100 130		05.04 05.04 05.04 09.05 09.05	08.05		BA2326	23620 16,7 +/WK BOS
<b>TOYOTA IQ (09-)</b>								
	1.0 i 12V 1.33 1.4 D-4D	50 72 66		01.09 01.09 01.09			BA2294	23510 16,5 +/WK AKE
<b>TOYOTA MR2 (00-05)</b>								
	1.8 VVTi (ZZW30)	103		04.00	09.05		BA2294	23510 16,5 +/WK AKE

<sup>1)</sup> country of manufacture  / paese del costruttore  / pays du constructeur  / país del fabricante 

<sup>2)</sup> country of manufacture  / paese del costruttore  / pays du constructeur  / país del fabricante 

								
<b>TOYOTA PASEO (91-95)</b>								
	1.5 i 16V (EL44)	85	04.91	07.95	BA2121			20870 15,0 AKE
<b>TOYOTA PASEO (95-99)</b>								
	1.5 i 16V (EL54)	66	08.95	12.99	BA2121			20870 15,0 AKE
<b>TOYOTA PICNIC (96-01)</b>								
	2.0 i 16V (SXM10) 2.2 TD (CXM10)	66	09.96 09.97	12.01 04.01	BA2116			21601 17,5 +/-WK SUM
<b>TOYOTA PREVIA (05-)</b>								
	2.4 i 16V (ACR50) 2.4 i 16V 4x4 (ACR50) 3.5 i V6 (GSR50) 3.5 i V6 4x4 (GSR50)	125 125 206 206	10.05 10.05 11.06 11.06		BA2326			23620 16,7 +/-WK BOS
<b>TOYOTA PRIUS (00-03)</b>								
	1.5 i 16V (NHW11)	53	05.00	07.03	BA2294			23510 16,5 +/-WK AKE
	1.5 i 16V (NHW11)	53	05.00	07.03	BA2293			23521 14,0 +/-WK SUM
	1.5 i 16V (NHW11)	53	05.00	07.03	BAR09139			269 9,0 8,0
<b>TOYOTA PRIUS (03-)</b>								
	1.5 VVTi (NHW20)	57	08.03		BA2294			23510 16,5 +/-WK AKE
	1.5 VVTi (NHW20)	57	08.03		BA2293			23521 14,0 +/-WK SUM
<b>TOYOTA RAV4 I (94-00)</b>								
	2.0 i 16V (SXA10) 2.0 i 16V (SXA10/11)	94 95	12.97 04.94	06.00 06.00	BA2116			21601 17,5 +/-WK SUM
<b>TOYOTA STARLET (89-96)</b>								
	1.0 (EP80) 1.3 (EP81)	40 55	12.89 12.89	11.90 + ABS 11.90 + ABS	BA2121			20870 15,0 AKE
	1.0 (EP80) 1.3 (EP81)	40 55	01.92 01.92	03.96 + ABS 03.96 + ABS	BAR18124			238 18,0 17,0 V
<b>TOYOTA STARLET (96-99)</b>								
	1.3 i 16V (EP91)	55	05.96	07.99	BA2121			20870 15,0 AKE
	1.3 i 16V (EP91)	55	05.96	07.99	BAR18124			238 18,0 17,0 V
<b>TOYOTA YARIS (99-05)</b>								
	1.0 i 16V 1.0 i 16V 1.3 i 16V 1.3 i 16V 1.4 D-4D 1.5 VVTi Sport 1.5 VVTi Sport 1.5 VVTi Turbo Sport	48 50 63 64 55 77 78 110	04.03 08.99 09.99 04.02 12.01 01.03 04.01 04.03	08.05 + HA-Scheibenbremse <sup>1)</sup> 03.03 + HA-Scheibenbremse <sup>1)</sup> 10.04 + HA-Scheibenbremse <sup>1)</sup> 03.03 + HA-Scheibenbremse <sup>1)</sup> 08.05 + HA-Scheibenbremse <sup>1)</sup> 08.05 + HA-Scheibenbremse <sup>1)</sup> 03.03 + HA-Scheibenbremse <sup>1)</sup> 10.04 + HA-Scheibenbremse <sup>1)</sup>	BA2294			23510 16,5 +/-WK AKE
	1.0 i 16V 1.0 i 16V 1.3 i 16V 1.3 i 16V 1.4 D-4D 1.5 VVTi Sport 1.5 VVTi Sport 1.5 VVTi Turbo Sport	48 50 63 64 55 77 78 110	04.03 03.99 09.99 04.02 12.01 01.03 04.01 04.03	08.05 + ABS 03.03 + ABS 10.04 + ABS 08.05 + ABS 08.05 + ABS 08.05 03.03 10.04	BA2293			23521 14,0 +/-WK SUM
	1.0 i 16V 1.0 i 16V 1.3 i 16V 1.3 i 16V 1.4 D-4D 1.5 VVTi Sport 1.5 VVTi Sport 1.5 VVTi Turbo Sport	48 50 63 64 55 77 78 110	04.03 03.99 09.99 04.02 12.01 01.03 04.01 04.03	08.05 + ABS 03.03 + ABS 10.04 + ABS 08.05 + ABS 08.05 + ABS 08.05 03.03 10.04	BAR09139			269 9,0 8,0

<sup>1)</sup> + RA disc brake / + P disco freno / + frein à disque essieu AR / + ET-disco de freno

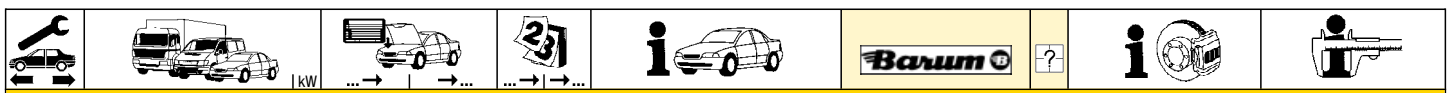

**TOYOTA YARIS VERSO (99-05)**





	1.3 i 16V	62		<b>01.03</b>	<b>09.05</b>	<b>BA2294</b>		23510 16,5 +/WK	<b>AKE</b>
	1.3 i 16V	63		<b>11.99</b>	<b>03.03</b>				
	1.4 D-4D	55		<b>12.01</b>	<b>09.05</b>				
	1.5 VVTi	77		<b>05.03</b>	<b>09.05</b>				
	1.5 VVTi Sport	78		<b>03.00</b>	<b>03.03</b>				
	1.3 i 16V	62		<b>01.03</b>	<b>09.05</b> + ABS	<b>BA2293</b>		23521 14,0 +/WK	<b>SUM</b>
	1.3 i 16V	63		<b>11.99</b>	<b>03.03</b> + ABS				
	1.4 D-4D	55		<b>12.01</b>	<b>09.05</b> + ABS				
	1.5 VVTi	77		<b>05.03</b>	<b>09.05</b> + ABS				
	1.5 VVTi Sport	78		<b>03.00</b>	<b>03.03</b> + ABS				
	1.3 i 16V	62		<b>01.03</b>	<b>09.05</b> + ABS	<b>BAR09139</b>		269 9,0 8,0	
	1.3 i 16V	63		<b>11.99</b>	<b>03.03</b> + ABS				
	1.4 D-4D	55		<b>12.01</b>	<b>09.05</b> + ABS				
	1.5 VVTi	77		<b>05.03</b>	<b>09.05</b> + ABS				
	1.5 VVTi Sport	78		<b>03.00</b>	<b>03.03</b> + ABS				

**VOLKSWAGEN BORA (98-04)**



	1.4 16V		1J-X-800000	<b>09.98</b>	PR: 1LR,1LS,1LQ,1ZM	<b>BA2154</b>		23130 19,6 +	<b>VW</b>
	1.6		1J-X-800000	<b>09.98</b>	PR: 1LR,1LS,1LQ,1ZM				
	1.8	92	1J-X-800000	<b>09.98</b>	PR: 1LR,1LS,1LQ,1ZM				
	1.8 4motion	92	1J-X-800000	<b>02.99</b>	PR: 1LR,1LS,1LQ,1ZM				
	1.9 SDI		1J-X-800000	<b>09.98</b>	PR: 1LR,1LS,1LQ,1ZM				
	1.9 TDI	66	1J-X-800000	<b>09.98</b>	PR: 1LR,1LS,1LQ,1ZM				
	1.9 TDI	81	1J-X-800000	<b>09.98</b>	PR: 1LR,1LS,1LQ,1ZM				
	1.9 TDI	85	1J-X-800000	<b>02.99</b>	PR: 1LR,1LS,1LQ,1ZM				
	1.9 TDI 4motion	66	1J-X-800000	<b>02.99</b>	PR: 1LR,1LS,1LQ,1ZM				
	1.9 TDI 4motion	85	1J-X-800000	<b>02.99</b>	PR: 1LR,1LS,1LQ,1ZM				
	2.0	85	1J-X-800000	<b>09.98</b>	PR: 1LR,1LS,1LQ,1ZM				
	2.3 V5		1J-X-800000	<b>09.98</b>	PR: 1LR,1LS,1LQ,1ZM				
	2.3 V5 4motion		1J-X-800000	<b>02.99</b>	PR: 1LR,1LS,1LQ,1ZM				
	1.4 16V	1J-Y-000001		<b>12.04</b>	PR: 1LS,1LQ,1ZP,1ZM				
	1.6	1J-Y-000001		<b>12.04</b>	PR: 1LS,1LQ,1ZP,1ZM				
	1.6 16V			<b>02.00</b>	PR: 1LS,1LQ,1ZP,1ZM				
1.6 FSI			<b>01.02</b>	PR: 1LS,1LQ,1ZP,1ZM					
1.8	92 1J-Y-000001		<b>12.04</b>	PR: 1LS,1LQ,1ZP,1ZM					
1.8 4motion	92 1J-Y-000001		<b>12.04</b>	PR: 1LS,1LQ,1ZP,1ZM					
1.8 T	110		<b>09.00</b>	PR: 1LS,1LQ,1ZP,1ZM					
1.8 T	132		<b>05.02</b>	PR: 1LS,1LQ,1ZP,1ZM					
1.9 SDI	1J-Y-000001		<b>12.04</b>	PR: 1LS,1LQ,1ZP,1ZM					
1.9 TDI	66 1J-Y-000001		<b>06.01</b>	PR: 1LS,1LQ,1ZP,1ZM					
1.9 TDI	74		<b>09.00</b>	PR: 1LS,1LQ,1ZP,1ZM					
1.9 TDI	81 1J-Y-000001		<b>06.01</b>	PR: 1LS,1LQ,1ZP,1ZM					
1.9 TDI	85 1J-Y-000001		<b>06.01</b>	PR: 1LS,1LQ,1ZP,1ZM					
1.9 TDI	96		<b>04.01</b>	PR: 1LS,1LQ,1ZP,1ZM					
1.9 TDI	110		<b>10.00</b>	PR: 1LS,1LQ,1ZP,1ZM					
1.9 TDI 4motion	66 1J-Y-000001		<b>06.01</b>	PR: 1LS,1LQ,1ZP,1ZM					
1.9 TDI 4motion	74		<b>09.00</b>	PR: 1LS,1LQ,1ZP,1ZM					
1.9 TDI 4motion	85 1J-Y-000001		<b>06.01</b>	PR: 1LS,1LQ,1ZP,1ZM					
1.9 TDI 4motion	96		<b>04.01</b>	PR: 1LS,1LQ,1ZP,1ZM					
1.9 TDI 4motion	110		<b>10.00</b>	PR: 1LS,1LQ,1ZP,1ZM					
2.0	85 1J-Y-000001		<b>12.04</b>	PR: 1LS,1LQ,1ZP,1ZM					
2.0 4motion	85		<b>04.00</b>	PR: 1LS,1LQ,1ZP,1ZM					
2.3 V5	1J-Y-000001		<b>12.04</b>	PR: 1LS,1LQ,1ZP,1ZM					
2.3 V5 4motion	1J-Y-000001		<b>12.04</b>	PR: 1LS,1LQ,1ZP,1ZM					
2.8 V6 4motion	150		<b>05.99</b>	PR: 1LS,1LQ,1ZP,1ZM					
	1.4 16V		<b>09.98</b>	PR: 1LN,1ZD,1ZE,1ZH	<b>BA2205</b>		23392 20,6 +/WK	<b>ATE</b>	
	1.6		<b>09.98</b>	PR: 1LN,1ZD,1ZE,1ZH					
	1.6 16V		<b>02.00</b>	PR: 1LN,1ZD,1ZE,1ZH					
	1.6 FSI		<b>01.02</b>	PR: 1LN,1ZD,1ZE,1ZH					
	1.8	92	<b>09.98</b>	PR: 1LN,1ZD,1ZE,1ZH					
	1.8 4motion	92	<b>02.99</b>	PR: 1LN,1ZD,1ZE,1ZH					
	1.8 T	110	<b>09.00</b>	PR: 1LN,1ZD,1ZE,1ZH					
	1.8 T	132	<b>05.02</b>	PR: 1LN,1ZD,1ZE,1ZH					
	1.9 SDI		<b>09.98</b>	PR: 1LN,1ZD,1ZE,1ZH					
	1.9 TDI	66	<b>09.98</b>	PR: 1LN,1ZD,1ZE,1ZH					
	1.9 TDI	74	<b>09.00</b>	PR: 1LN,1ZD,1ZE,1ZH					
	1.9 TDI	81	<b>09.98</b>	PR: 1LN,1ZD,1ZE,1ZH					
	1.9 TDI	85	<b>02.99</b>	PR: 1LN,1ZD,1ZE,1ZH					
	1.9 TDI	96	<b>04.01</b>	PR: 1LN,1ZD,1ZE,1ZH					
	1.9 TDI	110	<b>10.00</b>	PR: 1LN,1ZD,1ZE,1ZH					
	1.9 TDI 4motion	66	<b>02.99</b>	PR: 1LN,1ZD,1ZE,1ZH					
1.9 TDI 4motion	74	<b>09.00</b>	PR: 1LN,1ZD,1ZE,1ZH						
1.9 TDI 4motion	85	<b>02.99</b>	PR: 1LN,1ZD,1ZE,1ZH						
1.9 TDI 4motion	96	<b>04.01</b>	PR: 1LN,1ZD,1ZE,1ZH						
1.9 TDI 4motion	110	<b>10.00</b>	PR: 1LN,1ZD,1ZE,1ZH						
2.0	85	<b>09.98</b>	PR: 1LN,1ZD,1ZE,1ZH						
2.0 4motion	85	<b>04.00</b>	PR: 1LN,1ZD,1ZE,1ZH						
2.3 V5		<b>09.98</b>	PR: 1LN,1ZD,1ZE,1ZH						
2.3 V5 4motion		<b>02.99</b>	PR: 1LN,1ZD,1ZE,1ZH						
2.8 V6 4motion	150	<b>05.99</b>	PR: 1LN,1ZD,1ZE,1ZH						
	1.4 16V		<b>09.98</b>	PR: 1LR,1LS,1ZP,1ZM	<b>BAR22150</b>		280 22,0 19,0 V L		
	1.6		<b>09.98</b>	PR: 1LR,1LS,1ZP,1ZM					
	1.6 16V		<b>02.00</b>	PR: 1LR,1LS,1ZP,1ZM					
	1.6 FSI		<b>01.02</b>	PR: 1LR,1LS,1ZP,1ZM					
	1.8	92	<b>09.98</b>	PR: 1LR,1LS,1ZP,1ZM					
	1.8 4motion	92	<b>02.99</b>	PR: 1LR,1LS,1ZP,1ZM					
1.8 T	110	<b>09.00</b>	PR: 1LR,1LS,1ZP,1ZM						

















VOLKSWAGEN BORA (98-04)													
	1.8 T	132	05.02	12.04	PR: 1LR,1LS,1ZP,1ZM	BAR22150			280 22,0 19,0 V L				
	1.9 SDI		09.98	12.04	PR: 1LR,1LS,1ZP,1ZM								
	1.9 TDI	66	09.98	06.01	PR: 1LR,1LS,1ZP,1ZM								
	1.9 TDI	74	09.00	12.04	PR: 1LR,1LS,1ZP,1ZM								
	1.9 TDI	81	09.98	06.01	PR: 1LR,1LS,1ZP,1ZM								
	1.9 TDI	85	02.99	06.01	PR: 1LR,1LS,1ZP,1ZM								
	1.9 TDI	96	04.01	12.04	PR: 1LR,1LS,1ZP,1ZM								
	1.9 TDI	110	10.00	12.04	PR: 1LR,1LS,1ZP,1ZM								
	1.9 TDI 4motion	66	02.99	06.01	PR: 1LR,1LS,1ZP,1ZM								
	1.9 TDI 4motion	74	09.00	12.04	PR: 1LR,1LS,1ZP,1ZM								
	1.9 TDI 4motion	85	02.99	06.01	PR: 1LR,1LS,1ZP,1ZM								
	1.9 TDI 4motion	96	04.01	12.04	PR: 1LR,1LS,1ZP,1ZM								
	1.9 TDI 4motion	110	10.00	12.04	PR: 1LR,1LS,1ZP,1ZM								
	2.0	85	09.98	12.04	PR: 1LR,1LS,1ZP,1ZM								
	2.0 4motion	85	04.00	12.04	PR: 1LR,1LS,1ZP,1ZM								
2.3 V5		09.98	12.04	PR: 1LR,1LS,1ZP,1ZM									
2.3 V5 4motion		02.99	12.04	PR: 1LR,1LS,1ZP,1ZM									
2.8 V6 4motion	150	05.99	12.04	PR: 1LR,1LS,1ZP,1ZM									
1.4 16V		09.98	12.04	PR: 1LQ	BAR22151			256 22,0 19,0 V L					
1.6		09.98	12.04	PR: 1LQ									
1.6 16V		02.00	12.04	PR: 1LQ									
1.6 FSI		01.02	12.04	PR: 1LQ									
1.8	92	09.98	12.04	PR: 1LQ									
1.8 4motion	92	02.99	12.04	PR: 1LQ									
1.8 T	110	09.00	12.04	PR: 1LQ									
1.8 T	132	05.02	12.04	PR: 1LQ									
1.9 SDI		09.98	12.04	PR: 1LQ									
1.9 TDI	66	09.98	06.01	PR: 1LQ									
1.9 TDI	74	09.00	12.04	PR: 1LQ									
1.9 TDI	81	09.98	06.01	PR: 1LQ									
1.9 TDI	85	02.99	06.01	PR: 1LQ									
1.9 TDI	96	04.01	12.04	PR: 1LQ									
1.9 TDI	110	10.00	12.04	PR: 1LQ									
1.9 TDI 4motion	66	02.99	06.01	PR: 1LQ									
1.9 TDI 4motion	74	09.00	12.04	PR: 1LQ									
1.9 TDI 4motion	85	02.99	06.01	PR: 1LQ									
1.9 TDI 4motion	96	04.01	12.04	PR: 1LQ									
1.9 TDI 4motion	110	10.00	12.04	PR: 1LQ									
2.0	85	09.98	12.04	PR: 1LQ									
2.0 4motion	85	04.00	12.04	PR: 1LQ									
2.3 V5		09.98	12.04	PR: 1LQ									
2.3 V5 4motion		02.99	12.04	PR: 1LQ									
2.8 V6 4motion	150	05.99	12.04	PR: 1LQ									
1.4 16V		09.98	12.04	PR: 1LN,1ZD,1ZE,1ZH	BAR25113			288 25,0 22,0 V L					
1.6		09.98	12.04	PR: 1LN,1ZD,1ZE,1ZH									
1.6 16V		02.00	12.04	PR: 1LN,1ZD,1ZE,1ZH									
1.6 FSI		01.02	12.04	PR: 1LN,1ZD,1ZE,1ZH									
1.8	92	09.98	12.04	PR: 1LN,1ZD,1ZE,1ZH									
1.8 4motion	92	02.99	12.04	PR: 1LN,1ZD,1ZE,1ZH									
1.8 T	110	09.00	12.04	PR: 1LN,1ZD,1ZE,1ZH									
1.8 T	132	05.02	12.04	PR: 1LN,1ZD,1ZE,1ZH									
1.9 SDI		09.98	12.04	PR: 1LN,1ZD,1ZE,1ZH									
1.9 TDI	66	09.98	06.01	PR: 1LN,1ZD,1ZE,1ZH									
1.9 TDI	74	09.00	12.04	PR: 1LN,1ZD,1ZE,1ZH									
1.9 TDI	81	09.98	06.01	PR: 1LN,1ZD,1ZE,1ZH									
1.9 TDI	85	02.99	06.01	PR: 1LN,1ZD,1ZE,1ZH									
1.9 TDI	96	04.01	12.04	PR: 1LN,1ZD,1ZE,1ZH									
1.9 TDI	110	10.00	12.04	PR: 1LN,1ZD,1ZE,1ZH									
1.9 TDI 4motion	66	02.99	06.01	PR: 1LN,1ZD,1ZE,1ZH									
1.9 TDI 4motion	74	09.00	12.04	PR: 1LN,1ZD,1ZE,1ZH									
1.9 TDI 4motion	85	02.99	06.01	PR: 1LN,1ZD,1ZE,1ZH									
1.9 TDI 4motion	96	04.01	12.04	PR: 1LN,1ZD,1ZE,1ZH									
1.9 TDI 4motion	110	10.00	12.04	PR: 1LN,1ZD,1ZE,1ZH									
2.0	85	09.98	12.04	PR: 1LN,1ZD,1ZE,1ZH									
2.0 4motion	85	04.00	12.04	PR: 1LN,1ZD,1ZE,1ZH									
2.3 V5		09.98	12.04	PR: 1LN,1ZD,1ZE,1ZH									
2.3 V5 4motion		02.99	12.04	PR: 1LN,1ZD,1ZE,1ZH									
2.8 V6 4motion	150	05.99	12.04	PR: 1LN,1ZD,1ZE,1ZH									
1.4 16V		09.98	12.04	PR: 1LJ,1ZQ	BAR25123			312 25,0 23,0 V L					
1.6		09.98	12.04	PR: 1LJ,1ZQ									
1.6 16V		02.00	12.04	PR: 1LJ,1ZQ									
1.6 FSI		01.02	12.04	PR: 1LJ,1ZQ									
1.8	92	09.98	12.04	PR: 1LJ,1ZQ									
1.8 4motion	92	02.99	12.04	PR: 1LJ,1ZQ									
1.8 T	110	09.00	12.04	PR: 1LJ,1ZQ									
1.8 T	132	05.02	12.04	PR: 1LJ,1ZQ									
1.9 SDI		09.98	12.04	PR: 1LJ,1ZQ									
1.9 TDI	66	09.98	06.01	PR: 1LJ,1ZQ									
1.9 TDI	74	09.00	12.04	PR: 1LJ,1ZQ									
1.9 TDI	81	09.98	06.01	PR: 1LJ,1ZQ									
1.9 TDI	85	02.99	06.01	PR: 1LJ,1ZQ									
1.9 TDI	96	04.01	12.04	PR: 1LJ,1ZQ									
1.9 TDI	110	10.00	12.04	PR: 1LJ,1ZQ									
1.9 TDI 4motion	66	02.99	06.01	PR: 1LJ,1ZQ									
1.9 TDI 4motion	74	09.00	12.04	PR: 1LJ,1ZQ									
1.9 TDI 4motion	85	02.99	06.01	PR: 1LJ,1ZQ									
1.9 TDI 4motion	96	04.01	12.04	PR: 1LJ,1ZQ									



**VOLKSWAGEN BORA (98-04)**

	1.9 TDI 4motion 110 2.0 85 2.0 4motion 85 2.3 V5 2.3 V5 4motion 2.8 V6 4motion 150	10.00 09.98 04.00 09.98 02.99 05.99	12.04 PR: 1LJ,1ZQ 12.04 PR: 1LJ,1ZQ 12.04 PR: 1LJ,1ZQ 12.04 PR: 1LJ,1ZQ 12.04 PR: 1LJ,1ZQ 12.04 PR: 1LJ,1ZQ	BAR25123		312 25,0 23,0 V L
	1.4 16V 1.6 1.6 16V 1.6 FSI 1.8 92 1.8 4motion 92 1.8 T 110 1.8 T 132 1.9 SDI 1.9 TDI 66 1.9 TDI 74 1.9 TDI 81 1.9 TDI 85 1.9 TDI 96 1.9 TDI 110 1.9 TDI 4motion 66 1.9 TDI 4motion 85 2.0 85 2.0 4motion 85 2.3 V5 2.3 V5 4motion 2.8 V6 4motion 150	09.98 09.98 02.00 01.02 09.98 02.99 09.00 05.02 09.98 09.98 09.00 09.98 02.99 04.01 10.00 02.99 02.99 09.98 02.99 05.99	12.04 12.04 12.04 12.04 12.04 08.00 12.04 12.04 12.04 06.01 12.04 06.01 12.04 12.04 08.00 08.00 12.04 08.00 08.00	BAH0023	2	L=435
	1.4 16V 1.6 1.6 16V 1.6 FSI 1.8 92 1.8 4motion 92 1.8 T 110 1.8 T 132 1.9 SDI 1.9 TDI 66 1.9 TDI 74 1.9 TDI 81 1.9 TDI 85 1.9 TDI 96 1.9 TDI 110 1.9 TDI 4motion 66 1.9 TDI 4motion 74 1.9 TDI 4motion 85 1.9 TDI 4motion 96 1.9 TDI 4motion 110 2.0 85 2.0 4motion 85 2.3 V5 2.3 V5 4motion 2.8 V6 4motion 150	09.98 09.98 02.00 01.02 09.98 02.99 09.00 05.02 09.98 09.98 09.00 09.98 02.99 04.01 10.00 02.99 09.00 02.99 04.01 10.00 09.98 04.00 09.98 02.99 05.99	12.04 PR: 1KE,1KP,1KT 12.04 PR: 1KE,1KP,1KT 12.04 PR: 1KE,1KP,1KT 12.04 PR: 1KE,1KP,1KT 12.04 PR: 1KE,1KP,1KT 12.04 PR: 1KE,1KP,1KT 12.04 PR: 1KE,1KP,1KT 12.04 PR: 1KE,1KP,1KT 12.04 PR: 1KE,1KP,1KT 06.01 PR: 1KE,1KP,1KT 12.04 PR: 1KE,1KP,1KT 06.01 PR: 1KE,1KP,1KT 06.01 PR: 1KE,1KP,1KT 12.04 PR: 1KE,1KP,1KT 06.01 PR: 1KE,1KP,1KT 12.04 PR: 1KE,1KP,1KT 06.01 PR: 1KE,1KP,1KT 12.04 PR: 1KE,1KP,1KT 12.04 PR: 1KE,1KP,1KT 12.04 PR: 1KE,1KP,1KT 12.04 PR: 1KE,1KP,1KT 12.04 PR: 1KE,1KP,1KT 12.04 PR: 1KE,1KP,1KT 12.04 PR: 1KE,1KP,1KT 12.04 PR: 1KE,1KP,1KT	BA2017		20961 17,2 /S LUC
	1.4 16V 1.6 1.6 16V 1.6 FSI 1.8 92 1.8 4motion 92 1.8 T 110 1.8 T 132 1.9 SDI 1.9 TDI 66 1.9 TDI 74 1.9 TDI 81 1.9 TDI 85 1.9 TDI 96 1.9 TDI 110 1.9 TDI 4motion 66 1.9 TDI 4motion 74 1.9 TDI 4motion 85 1.9 TDI 4motion 96 1.9 TDI 4motion 110 2.0 85 2.0 4motion 85 2.3 V5 2.3 V5 4motion 2.8 V6 4motion 150	09.98 09.98 02.00 01.02 09.98 02.99 09.00 05.02 09.98 09.98 09.00 09.98 02.99 04.01 10.00 02.99 09.00 02.99 04.01 10.00 09.98 04.00 09.98 02.99 05.99	12.04 PR: 1KU,1KY,2EE 12.04 PR: 1KU,1KY,2EE 12.04 PR: 1KU,1KY,2EE 12.04 PR: 1KU,1KY,2EE 12.04 PR: 1KU,1KY,2EE 12.04 PR: 1KU,1KY,2EE 12.04 PR: 1KU,1KY,2EE 12.04 PR: 1KU,1KY,2EE 12.04 PR: 1KU,1KY,2EE 06.01 PR: 1KU,1KY,2EE 12.04 PR: 1KU,1KY,2EE 06.01 PR: 1KU,1KY,2EE 06.01 PR: 1KU,1KY,2EE 12.04 PR: 1KU,1KY,2EE 12.04 PR: 1KU,1KY,2EE 06.01 PR: 1KU,1KY,2EE 12.04 PR: 1KU,1KY,2EE 06.01 PR: 1KU,1KY,2EE 12.04 PR: 1KU,1KY,2EE 12.04 PR: 1KU,1KY,2EE 12.04 PR: 1KU,1KY,2EE 12.04 PR: 1KU,1KY,2EE 12.04 PR: 1KU,1KY,2EE 12.04 PR: 1KU,1KY,2EE 12.04 PR: 1KU,1KY,2EE	BA2032		20961 15,2 /S LUC
	1.4 16V 1.6 1.6 16V 1.6 FSI 1.8 92 1.8 4motion 92 1.8 T 110 1.8 T 132 1.9 SDI	09.98 09.98 02.00 01.02 09.98 02.99 09.00 05.02 09.98	12.04 PR: 1KP,1KT 12.04 PR: 1KP,1KT 12.04 PR: 1KP,1KT 12.04 PR: 1KP,1KT 12.04 PR: 1KP,1KT 12.04 PR: 1KP,1KT 12.04 PR: 1KP,1KT 12.04 PR: 1KP,1KT 12.04 PR: 1KP,1KT	BAR09123		232 8,9 7,0





















**VOLKSWAGEN BORA (98-04)**

	1.9 TDI	66	09.98	06.01	PR: 1KP,1KT	BAR09123		232 8,9 7,0
	1.9 TDI	74	09.00	12.04	PR: 1KP,1KT			
	1.9 TDI	81	09.98	06.01	PR: 1KP,1KT			
	1.9 TDI	85	02.99	06.01	PR: 1KP,1KT			
	1.9 TDI	96	04.01	12.04	PR: 1KP,1KT			
	1.9 TDI	110	10.00	12.04	PR: 1KP,1KT			
	1.9 TDI 4motion	66	02.99	06.01	PR: 1KP,1KT			
	1.9 TDI 4motion	74	09.00	12.04	PR: 1KP,1KT			
	1.9 TDI 4motion	85	02.99	06.01	PR: 1KP,1KT			
	1.9 TDI 4motion	96	04.01	12.04	PR: 1KP,1KT			
	1.9 TDI 4motion	110	10.00	12.04	PR: 1KP,1KT			
	2.0	85	09.98	12.04	PR: 1KP,1KT			
	2.0 4motion	85	04.00	12.04	PR: 1KP,1KT			
	2.3 V5		09.98	12.04	PR: 1KP,1KT			
	2.3 V5 4motion		02.99	12.04	PR: 1KP,1KT			
2.8 V6 4motion	150	05.99	12.04	PR: 1KP,1KT				
	1.4 16V		09.98	12.04	PR: 1KE	BAR09133		239 8,9 7,0
	1.6		09.98	12.04	PR: 1KE			
	1.6 16V		02.00	12.04	PR: 1KE			
	1.6 FSI		01.02	12.04	PR: 1KE			
	1.8	92	09.98	12.04	PR: 1KE			
	1.8 4motion	92	02.99	12.04	PR: 1KE			
	1.8 T	110	09.00	12.04	PR: 1KE			
	1.8 T	132	05.02	12.04	PR: 1KE			
	1.9 SDI		09.98	12.04	PR: 1KE			
	1.9 TDI	66	09.98	06.01	PR: 1KE			
	1.9 TDI	74	09.00	12.04	PR: 1KE			
	1.9 TDI	81	09.98	06.01	PR: 1KE			
	1.9 TDI	85	02.99	06.01	PR: 1KE			
	1.9 TDI	96	04.01	12.04	PR: 1KE			
	1.9 TDI	110	10.00	12.04	PR: 1KE			
	1.9 TDI 4motion	66	02.99	06.01	PR: 1KE			
	1.9 TDI 4motion	74	09.00	12.04	PR: 1KE			
	1.9 TDI 4motion	85	02.99	06.01	PR: 1KE			
	1.9 TDI 4motion	96	04.01	12.04	PR: 1KE			
	1.9 TDI 4motion	110	10.00	12.04	PR: 1KE			
2.0	85	09.98	12.04	PR: 1KE				
2.0 4motion	85	04.00	12.04	PR: 1KE				
2.3 V5		09.98	12.04	PR: 1KE				
2.3 V5 4motion		02.99	12.04	PR: 1KE				
2.8 V6 4motion	150	05.99	12.04	PR: 1KE				
	1.4 16V		09.98	12.04	PR: 1KU,1KY,2EE	BAR22163		256 22,0 20,0 VL
	1.6		09.98	12.04	PR: 1KU,1KY,2EE			
	1.6 16V		02.00	12.04	PR: 1KU,1KY,2EE			
	1.6 FSI		01.02	12.04	PR: 1KU,1KY,2EE			
	1.8	92	09.98	12.04	PR: 1KU,1KY,2EE			
	1.8 4motion	92	02.99	12.04	PR: 1KU,1KY,2EE			
	1.8 T	110	09.00	12.04	PR: 1KU,1KY,2EE			
	1.8 T	132	05.02	12.04	PR: 1KU,1KY,2EE			
	1.9 SDI		09.98	12.04	PR: 1KU,1KY,2EE			
	1.9 TDI	66	09.98	06.01	PR: 1KU,1KY,2EE			
	1.9 TDI	74	09.00	12.04	PR: 1KU,1KY,2EE			
	1.9 TDI	81	09.98	06.01	PR: 1KU,1KY,2EE			
	1.9 TDI	85	02.99	06.01	PR: 1KU,1KY,2EE			
	1.9 TDI	96	04.01	12.04	PR: 1KU,1KY,2EE			
	1.9 TDI	110	10.00	12.04	PR: 1KU,1KY,2EE			
	1.9 TDI 4motion	66	02.99	06.01	PR: 1KU,1KY,2EE			
	1.9 TDI 4motion	74	09.00	12.04	PR: 1KU,1KY,2EE			
	1.9 TDI 4motion	85	02.99	06.01	PR: 1KU,1KY,2EE			
	1.9 TDI 4motion	96	04.01	12.04	PR: 1KU,1KY,2EE			
	1.9 TDI 4motion	110	10.00	12.04	PR: 1KU,1KY,2EE			
2.0	85	09.98	12.04	PR: 1KU,1KY,2EE				
2.0 4motion	85	04.00	12.04	PR: 1KU,1KY,2EE				
2.3 V5		09.98	12.04	PR: 1KU,1KY,2EE				
2.3 V5 4motion		02.99	12.04	PR: 1KU,1KY,2EE				
2.8 V6 4motion	150	05.99	12.04	PR: 1KU,1KY,2EE				
	1.4 16V		09.98	12.04		BAH0033	2	L=140
	1.6		09.98	12.04				
	1.6 16V		02.00	12.04				
	1.6 FSI		01.02	12.04				
	1.8	92	09.98	12.04				
	1.8 T	110	09.00	12.04				
	1.8 T	132	05.02	12.04				
	1.9 SDI		09.98	12.04				
	1.9 TDI	66	09.98	06.01				
	1.9 TDI	74	09.00	12.04				
	1.9 TDI	81	09.98	06.01				
	1.9 TDI	85	02.99	06.01				
	1.9 TDI	96	04.01	12.04				
	1.9 TDI	110	10.00	12.04				
	2.0	85	09.98	12.04				
2.3 V5		09.98	12.04					
	1.8 4motion	92	02.99	12.04		BAH0033	2	L=140
	1.9 TDI 4motion	66	02.99	06.01				
	1.9 TDI 4motion	74	09.00	12.04				
	1.9 TDI 4motion	85	02.99	06.01				
	1.9 TDI 4motion	96	04.01	12.04				

VOLKSWAGEN BORA (98-04)									
									
	1.9 TDI 4motion	110		10.00	12.04		BAH0033	2	L=140
	2.0 4motion	85		04.00	12.04				
	2.3 V5 4motion			02.99	12.04				
	2.8 V6 4motion	150		05.99	12.04				
VOLKSWAGEN CADDY II (96-03)									
	1.4			9K-T-514500	11.95		BA2038		20168 19,6 /S LUC
	1.6			9K-T-514500	11.95				
	1.9 D			9K-T-514500	11.95				
	1.9 SDI			9K-T-514500	11.95				
	1.4	9K-T-514501			06.03		BA2018		21945 16,3 /S LUC
	1.6	9K-T-514501			06.03				
	1.7 SDI				07.96				
	1.9 D	9K-T-514501			06.03				
	1.9 SDI	9K-T-514501			06.03				
	1.9 TDI				09.96		06.03		
	1.4			9K-T-514500	11.95		BAR13178		256 12,9 11,0
	1.6			9K-T-514500	11.95				
	1.9 D			9K-T-514500	11.95				
	1.9 SDI			9K-T-514500	11.95				
	1.4	9K-T-514501			06.03		BAR20128		256 20,0 18,0 V L
	1.6	9K-T-514501			06.03				
	1.7 SDI				07.96				
	1.9 D	9K-T-514501			06.03				
	1.9 SDI	9K-T-514501			06.03				
	1.9 TDI				09.96		06.03		
	1.4				11.95	06.03	BAH0005	2	L=435
	1.6				11.95	06.03			
	1.7 SDI				07.96	06.03			
	1.9 D				11.95	06.03			
	1.9 SDI				11.95	06.03			
	1.9 TDI				09.96	06.03			
	1.4				11.95	06.03	BAW2004		Rz 20,64
	1.6				11.95	06.03			
	1.7 SDI				07.96	06.03			
	1.9 D				11.95	06.03			
	1.9 SDI				11.95	06.03			
	1.9 TDI				09.96	06.03			
	1.4			9K-Y-500747	11.95		BAE5006		230 x 40 HEB VW
	1.6			9K-Y-500747	11.95				
	1.7 SDI			9K-Y-500747	07.96				
	1.9 D			9K-Y-500747	11.95				
	1.9 SDI			9K-Y-500747	11.95				
	1.9 TDI			9K-Y-500747	09.96				
	1.4	9K-Y-500748			06.03		BAE5009		230 x 32 HEB
	1.6	9K-Y-500748			06.03				
	1.7 SDI	9K-Y-500748			06.03				
	1.9 D	9K-Y-500748			06.03				
	1.9 SDI	9K-Y-500748			06.03				
	1.9 TDI	9K-Y-500748			06.03				
VOLKSWAGEN CADDY III (04-)									
	1.2 TSI				09.10	PR: 1ZF,1ZM	BA2155		23131 19,6 +/WK VW
	1.4	55			02.04	PR: 1ZF,1ZM			
	1.4 16V	59			05.06	PR: 1ZF,1ZM			
	1.6				04.04	PR: 1ZF,1ZM			
	1.6 TDI				08.10	PR: 1ZF,1ZM			
	1.9 TDI	55			09.05	PR: 1ZF,1ZM			
	1.9 TDI	77			02.04	PR: 1ZF,1ZM			
	1.9 TDI 4motion	77			05.08	PR: 1ZF,1ZM			
	2.0 Eco Fuel	80			04.06	PR: 1ZF,1ZM			
	2.0 SDI	51			02.04	PR: 1ZF,1ZM			
	2.0 TDI	81			10.10	PR: 1ZF,1ZM			
	2.0 TDI	103			09.07	PR: 1ZF,1ZM			
	2.0 TDI	125			05.12	PR: 1ZF,1ZM			
	2.0 TDI 4motion	81			10.10	PR: 1ZF,1ZM			
	1.2 TSI				09.10	PR: 1ZE,1LJ,1ZA	BA2195		23587 19,6 +/WK ATE
	1.4	55			02.04	PR: 1ZE,1LJ,1ZA			
	1.4 16V	59			05.06	PR: 1ZE,1LJ,1ZA			
	1.6				04.04	PR: 1ZE,1LJ,1ZA			
	1.6 TDI				08.10	PR: 1ZE,1LJ,1ZA			
	1.9 TDI	55			09.05	PR: 1ZE,1LJ,1ZA			
	1.9 TDI	77			02.04	PR: 1ZE,1LJ,1ZA			
	1.9 TDI 4motion	77			05.08	PR: 1ZE,1LJ,1ZA			
	2.0 Eco Fuel	80			04.06	PR: 1ZE,1LJ,1ZA			
	2.0 SDI	51			02.04	PR: 1ZE,1LJ,1ZA			
	2.0 TDI	81			10.10	PR: 1ZE,1LJ,1ZA			
	2.0 TDI	103			09.07	PR: 1ZE,1LJ,1ZA			
	2.0 TDI	125			05.12	PR: 1ZE,1LJ,1ZA			
	2.0 TDI 4motion	81			10.10	PR: 1ZE,1LJ,1ZA			
	1.2 TSI				09.10	PR: 1ZF,1ZM	BAR22210		280 22,0 19,0 V L
	1.4	55			02.04	PR: 1ZF,1ZM			
	1.4 16V	59			05.06	PR: 1ZF,1ZM			
	1.6				04.04	PR: 1ZF,1ZM			
	1.6 TDI				08.10	PR: 1ZF,1ZM			
	1.9 TDI	55			09.05	PR: 1ZF,1ZM			

VOLKSWAGEN CADDY III (04-)									
	1.9 TDI	77		02.04	PR: 1ZF,1ZM	BAR22210			280 22,0 19,0 V L
	1.9 TDI 4motion	77		05.08	PR: 1ZF,1ZM				
	2.0 Eco Fuel	80		04.06	PR: 1ZF,1ZM				
	2.0 SDI	51		02.04	PR: 1ZF,1ZM				
	2.0 TDI	81		10.10	PR: 1ZF,1ZM				
	2.0 TDI	103		09.07	PR: 1ZF,1ZM				
	2.0 TDI	125		05.12	PR: 1ZF,1ZM				
	2.0 TDI 4motion	81		10.10	PR: 1ZF,1ZM				
	1.2 TSI			09.10	PR: 1ZE	BAR25145		288 24,9 22,0 V L	
	1.4	55		02.04	PR: 1ZE				
	1.4 16V	59		05.06	PR: 1ZE				
	1.6			04.04	PR: 1ZE				
	1.6 TDI			08.10	PR: 1ZE				
	1.9 TDI	55		09.05	PR: 1ZE				
	1.9 TDI	77		02.04	PR: 1ZE				
	1.9 TDI 4motion	77		05.08	PR: 1ZE				
	2.0 Eco Fuel	80		04.06	PR: 1ZE				
	2.0 SDI	51		02.04	PR: 1ZE				
	2.0 TDI	81		10.10	PR: 1ZE				
	2.0 TDI	103		09.07	PR: 1ZE				
	2.0 TDI	125		05.12	PR: 1ZE				
	2.0 TDI 4motion	81		10.10	PR: 1ZE				
	1.2 TSI			09.10	PR: 1LJ,1ZA	BAR25158		312 25,0 22,0 V L	
	1.4	55		02.04	PR: 1LJ,1ZA				
	1.4 16V	59		05.06	PR: 1LJ,1ZA				
	1.6			04.04	PR: 1LJ,1ZA				
	1.6 TDI			08.10	PR: 1LJ,1ZA				
	1.9 TDI	55		09.05	PR: 1LJ,1ZA				
	1.9 TDI	77		02.04	PR: 1LJ,1ZA				
	1.9 TDI 4motion	77		05.08	PR: 1LJ,1ZA				
2.0 Eco Fuel	80		04.06	PR: 1LJ,1ZA					
2.0 SDI	51		02.04	PR: 1LJ,1ZA					
2.0 TDI	81		10.10	PR: 1LJ,1ZA					
2.0 TDI	103		09.07	PR: 1LJ,1ZA					
2.0 TDI	125		05.12	PR: 1LJ,1ZA					
2.0 TDI 4motion	81		10.10	PR: 1LJ,1ZA					
	1.4	55		02.04	11.07	BA2196		23914 16,3 /WE/S	LUC
	1.4 16V	59		05.06	11.07				
	1.6			04.04	11.07				
	1.9 TDI	55		09.05	11.07				
	1.9 TDI	77		02.04	11.07				
	2.0 Eco Fuel	80		04.06	11.07				
	2.0 SDI	51		02.04	11.07				
	2.0 TDI	103		09.07	11.07				
	1.2 TSI			09.10	PR: 1ZF,2E2	BA2017		20961 17,2 /S	LUC
	1.4	55		12.07	PR: 1ZF,2E2				
	1.4 16V	59		12.07	PR: 1ZF,2E2				
	1.6			12.07	PR: 1ZF,2E2				
	1.6 TDI			08.10	PR: 1ZF,2E2				
	1.9 TDI	55		12.07	PR: 1ZF,2E2				
	1.9 TDI	77		12.07	PR: 1ZF,2E2				
	1.9 TDI 4motion	77		05.08	PR: 1ZF,2E2				
	2.0 Eco Fuel	80		12.07	PR: 1ZF,2E2				
	2.0 SDI	51		12.07	PR: 1ZF,2E2				
	2.0 TDI	81		10.10	PR: 1ZF,2E2				
	2.0 TDI	103		12.07	PR: 1ZF,2E2				
	2.0 TDI	125		05.12	PR: 1ZF,2E2				
	2.0 TDI 4motion	81		10.10	PR: 1ZF,2E2				
	1.2 TSI			09.10	PR: 1ZE,1LJ	BA2196		23914 16,3 /WE/S	LUC
	1.4	55	2K-B-200 000	12.07	PR: 1ZE,1LJ				
1.4 16V	59	2K-B-200 000	12.07	PR: 1ZE,1LJ					
1.6		2K-B-200 000	12.07	PR: 1ZE,1LJ					
1.6 TDI		2K-B-200 000	08.10	PR: 1ZE,1LJ					
1.9 TDI	55	2K-B-200 000	12.07	PR: 1ZE,1LJ					
1.9 TDI	77	2K-B-200 000	12.07	PR: 1ZE,1LJ					
1.9 TDI 4motion	77	2K-B-200 000	05.08	PR: 1ZE,1LJ					
2.0 Eco Fuel	80	2K-B-200 000	12.07	PR: 1ZE,1LJ					
2.0 SDI	51	2K-B-200 000	12.07	PR: 1ZE,1LJ					
2.0 TDI	81	2K-B-200 000	10.10	PR: 1ZE,1LJ					
2.0 TDI	103	2K-B-200 000	12.07	PR: 1ZE,1LJ					
2.0 TDI 4motion	81	2K-B-200 000	10.10	PR: 1ZE,1LJ					
	1.4	55		02.04	11.07	BAR12158		256 12,0 10,0	
	1.4 16V	59		05.06	11.07				
	1.6			04.04	11.07				
	1.9 TDI	55		09.05	11.07				
	1.9 TDI	77		02.04	11.07				
	2.0 Eco Fuel	80		04.06	11.07				
	2.0 SDI	51		02.04	11.07				
	2.0 TDI	103		09.07	11.07				
	1.2 TSI			09.10	PR: 1ZE,1LJ	BAR12158		256 12,0 10,0	
	1.4	55	2K-B-200 000	12.07	PR: 1ZE,1LJ				
	1.4 16V	59	2K-B-200 000	12.07	PR: 1ZE,1LJ				
	1.6		2K-B-200 000	12.07	PR: 1ZE,1LJ				
1.6 TDI			08.10	PR: 1ZE,1LJ					
1.9 TDI	55	2K-B-200 000	12.07	PR: 1ZE,1LJ					
1.9 TDI	77	2K-B-200 000	12.07	PR: 1ZE,1LJ					



								
<b>VOLKSWAGEN CADDY III (04-)</b>								
	1.9 TDI 4motion 2.0 Eco Fuel 2.0 SDI 2.0 TDI 2.0 TDI 2.0 TDI 4motion	77 80 51 81 103 81	2K-B-200 000 2K-B-200 000 2K-B-200 000 2K-B-200 000 2K-B-200 000 2K-B-200 000	05.08 12.07 12.07 10.10 12.07 10.10	PR: 1ZE,1LJ PR: 1ZE,1LJ PR: 1ZE,1LJ PR: 1ZE,1LJ PR: 1ZE,1LJ PR: 1ZE,1LJ	BAR12158		256 12,0 10,0
<b>VOLKSWAGEN CADDY Pickup (97-02)</b>								
	1.6 1.9 D			10.97 10.97	12.00 12.00	BA2039		20861 17,5 /S LUC
	1.6 1.9 D			10.97 10.97	12.00 12.00	BAR13182		236 12,8 11,4
	1.6 1.9 D			10.97 10.97	12.00 12.00	BAE5001		200 x 40 HEB VW
<b>VOLKSWAGEN CC COUPE (11-)</b>								
	1.8 TSI 2.0 Blue TDI 2.0 TDI BlueMotion 2.0 TDI BlueMotion 2.0 TSI 3.6 V6 4motion	118 103 103 125 155 220		11.11 11.11 11.11 11.11 11.11 11.11	PR: 12M,12G PR: 12M,12G PR: 12M,12G PR: 12M,12G PR: 12M,12G PR: 12M,12G	BA2195		23587 19,6 +/WK ATE
	1.8 TSI 2.0 Blue TDI 2.0 TDI BlueMotion 2.0 TDI BlueMotion 2.0 TSI 3.6 V6 4motion	118 103 103 125 155 220		11.11 11.11 11.11 11.11 11.11 11.11	PR: 12M,12G PR: 12M,12G PR: 12M,12G PR: 12M,12G PR: 12M,12G PR: 12M,12G	BAR25158		312 25,0 22,0 V L
	1.8 TSI 2.0 Blue TDI 2.0 TDI BlueMotion 2.0 TDI BlueMotion 2.0 TSI 3.6 V6 4motion	118 103 103 125 155 220		11.11 11.11 11.11 11.11 11.11 11.11	PR: 2EA PR: 2EA PR: 2EA PR: 2EA PR: 2EA PR: 2EA	BA2196		23914 16,3 /WE/S LUC
	1.8 TSI 2.0 Blue TDI 2.0 TDI BlueMotion 2.0 TDI BlueMotion 2.0 TSI 3.6 V6 4motion	118 103 103 125 155 220		11.11 11.11 11.11 11.11 11.11 11.11	PR: 1KW PR: 1KW PR: 1KW PR: 1KW PR: 1KW PR: 1KW	BAR12169		282 12,0 10,0
<b>VOLKSWAGEN CRAFTER (06-)</b>								
	2.0 TDI BlueMotion 2.0 TDI BlueMotion 2.0 TDI BlueMotion 2.5 TDI 2.5 TDI 2.5 TDI 2.5 TDI	80 100 120 65 80 100 120		07.11 07.11 07.11 04.06 04.06 04.06 04.06	PR: OWC, OWL PR: OWC, OWL PR: OWC, OWL PR: OWC, OWL PR: OWC, OWL PR: OWC, OWL PR: OWC, OWL	BA2281		29192 20,9 /WE/Zub BRE
	2.0 TDI BlueMotion 2.0 TDI BlueMotion 2.0 TDI BlueMotion 2.5 TDI 2.5 TDI 2.5 TDI 2.5 TDI	80 100 120 65 80 100 120		07.11 07.11 07.11 04.06 04.06 04.06 04.06	PR: OWC, OWL PR: OWC, OWL PR: OWC, OWL PR: OWC, OWL PR: OWC, OWL PR: OWC, OWL PR: OWC, OWL	BA2277 BAV1048	2	29190 19,6 +/WE/S BOS Warnkontakt L=95mm
<b>VOLKSWAGEN EOS (06-)</b>								
	1.4 TSI 1.6 FSI 2.0 FSI 2.0 TDI 2.0 TFSI 2.0 TSI 3.2 V6 3.6 V6	85 110 147 155 184 191		10.07 05.06 05.06 05.06 05.06 11.09 05.06 05.09	PR: 1LJ,1ZA,1ZD,1ZE PR: 1LJ,1ZA,1ZD,1ZE PR: 1LJ,1ZA,1ZD,1ZE PR: 1LJ,1ZA,1ZD,1ZE PR: 1LJ,1ZA,1ZD,1ZE PR: 1LJ,1ZA,1ZD,1ZE PR: 1LJ,1ZA,1ZD,1ZE PR: 1LJ,1ZA,1ZD,1ZE	BA2195		23587 19,6 +/WK ATE
	1.4 TSI 1.6 FSI 2.0 FSI 2.0 TDI 2.0 TFSI 2.0 TSI 3.2 V6 3.6 V6	85 110 147 155 184 191		10.07 05.06 05.06 05.06 05.06 11.09 05.06 05.09	PR: 1ZE PR: 1ZE PR: 1ZE PR: 1ZE PR: 1ZE PR: 1ZE PR: 1ZE PR: 1ZE	BAR25145		288 24,9 22,0 V L
	1.4 TSI 1.6 FSI 2.0 FSI 2.0 TDI 2.0 TFSI 2.0 TSI 3.2 V6 3.6 V6	85 110 147 155 184 191		10.07 05.06 05.06 05.06 05.06 11.09 05.06 05.09	PR: 1LJ,1ZA,1ZD PR: 1LJ,1ZA,1ZD PR: 1LJ,1ZA,1ZD PR: 1LJ,1ZA,1ZD PR: 1LJ,1ZA,1ZD PR: 1LJ,1ZA,1ZD PR: 1LJ,1ZA,1ZD PR: 1LJ,1ZA,1ZD	BAR25158		312 25,0 22,0 V L

VOLKSWAGEN EOS (06-)										
	1.4 TSI			10.07	PR: 1KD	BA2017			20961 17,2 /S	LUC
	1.6 FSI	85		05.06	PR: 1KD					
	2.0 FSI	110		05.06	PR: 1KD					
	2.0 TDI			05.06	PR: 1KD					
	2.0 TFSI	147		05.06	PR: 1KD					
	2.0 TSI	155		11.09	PR: 1KD					
	3.2 V6	184		05.06	PR: 1KD					
3.6 V6	191		05.09	PR: 1KD						
	1.4 TSI			10.07	PR: 1KJ,1KZ	BA2196			23914 16,3 /WE/S	LUC
	1.6 FSI	85		05.06	PR: 1KJ,1KZ					
	2.0 FSI	110		05.06	PR: 1KJ,1KZ					
	2.0 TDI			05.06	PR: 1KJ,1KZ					
	2.0 TFSI	147		05.06	PR: 1KJ,1KZ					
	2.0 TSI	155		11.09	PR: 1KJ,1KZ					
	3.2 V6	184		05.06	PR: 1KJ,1KZ					
3.6 V6	191		05.09	PR: 1KJ,1KZ						
	1.4 TSI			10.07	PR: 2EA	BA2196			23914 16,3 /WE/S	LUC
	1.6 FSI	85		05.06	PR: 2EA					
	2.0 FSI	110		05.06	PR: 2EA					
	2.0 TDI			05.06	PR: 2EA					
	2.0 TFSI	147		05.06	PR: 2EA					
	2.0 TSI	155		11.09	PR: 2EA					
	3.2 V6	184		05.06	PR: 2EA					
3.6 V6	191		05.09	PR: 2EA						
	1.4 TSI			10.07	PR: 1KJ,1KZ	BAR12169			282 12,0 10,0	
	1.6 FSI	85		05.06	PR: 1KJ,1KZ					
	2.0 FSI	110		05.06	PR: 1KJ,1KZ					
	2.0 TDI			05.06	PR: 1KJ,1KZ					
	2.0 TFSI	147		05.06	PR: 1KJ,1KZ					
	2.0 TSI	155		11.09	PR: 1KJ,1KZ					
	3.2 V6	184		05.06	PR: 1KJ,1KZ					
3.6 V6	191		05.09	PR: 1KJ,1KZ						
VOLKSWAGEN FOX (05-)										
	1.0			10.03	PR: 1ZN	BA2152			21866 17,3 +	VW
	1.2			04.05	PR: 1ZN					
	1.4	55		04.05	PR: 1ZN					
	1.4 TDI	51		04.05	PR: 1ZN,1KZ					
	1.6			10.03	PR: 1ZN					
	1.9 D	47		12.07	PR: 1ZN					
	1.0			10.03	PR: 1ZF	BA2154			23130 19,6 +	VW
	1.2			04.05	PR: 1ZF					
	1.4	55		04.05	PR: 1ZF					
	1.4 TDI	51		04.05	PR: 1ZF					
	1.6			10.03	PR: 1ZF					
	1.9 D	47		12.07	PR: 1ZF					
	1.0			10.03	PR: 1ZN	BAR18137			239 18,0 16,0 V L	
	1.2			04.05	PR: 1ZN					
	1.4	55		04.05	PR: 1ZN					
	1.4 TDI	51		04.05	PR: 1ZN					
	1.6			10.03	PR: 1ZN					
	1.9 D	47		12.07	PR: 1ZN					
	1.0			10.03	PR: 1ZF	BAR22151			256 22,0 19,0 V L	
	1.2			04.05	PR: 1ZF					
	1.4	55		04.05	PR: 1ZF					
	1.4 TDI	51		04.05	PR: 1ZF					
	1.6			10.03	PR: 1ZF					
	1.9 D	47		12.07	PR: 1ZF					
	1.0			10.03		BAH0033	2		L=140	
	1.2			04.05						
	1.4	55		04.05						
	1.4 TDI	51		04.05						
	1.6			10.03						
	1.9 D	47		12.07						
	1.0			10.03		BAW1701			Rz 17,46	
	1.2			04.05						
	1.4	55		04.05						
	1.4 TDI	51		04.05						
	1.6			10.03						
	1.9 D	47		12.07						
	1.0			10.03		BAE5001			200 x 40 HEB	VW
	1.2			04.05						
	1.4	55		04.05						
	1.4 TDI	51		04.05						
	1.6			10.03						
	1.9 D	47		12.07						
VOLKSWAGEN GOLF II (84-93)										
	1.0	▶	19-E-855000	08.83		BA2131			20889 17,3 /Zub	VW
	1.0	▶		08.83	07.86					
	1.0	▶		08.86	10.91 - ABS					
	1.3	▶	19-E-855000	08.83						
	1.3	▶		08.83	07.86					
	1.3	▶		08.86	12.93 - ABS					
	1.6	▶		08.83	07.86					
	1.6 D	▶	19-E-855000	08.83	- ⊕					
	↓	↓								
	↓	↓								

VOLKSWAGEN GOLF II (84-93)		KW		i		Baum		?		i		i			
	1.6 D			08.83	07.86	- (⌚)		BA2131				20889	17,3 /Zub	VW	
	1.6 D			08.86	07.92	+ Schaltgetriebe 1)									
	1.0	▶	19-E-855001		07.86			BA2132					20887	19,7 +/Zub	VW
	1.0			08.89	10.91	+ ABS									
	1.3	▶	19-E-855001		07.86										
	1.3			08.89	12.93	+ ABS									
	1.6			08.86	12.93										
	1.6		55		08.83	07.86									
	1.6 D	▶	19-E-855001		07.86	- (⌚)									
	1.6 D			08.83	07.86	+ (⌚)									
	1.6 D			08.86	07.92	+ Automatikgetriebe 2)									
	1.6 TD			08.83	12.93										
	1.8		62		01.84	07.92	- ABS/ - GT								
	1.8		66		01.84	07.92	- ABS/ - GT								
1.8 Syncro				08.85	07.92										
	1.8		62 19-JH560001		07.92	+ ABS		BA2133				20887	15,3 +/Zub	VW	
	1.8		66 19-JH560001		07.92	+ ABS									
	1.8		77		08.88	07.92	+ (⌚)								
	1.8 GT			08.85	07.92										
	1.8 GT Special			08.85	07.92										
	1.8 GTI			01.84	07.92										
	1.8 GTI 16V			1G-KW240000	02.86										
	1.8 GTI 16V			1G-KB075000	02.86										
	1.8 GTI 16V		1G-KW240001		07.92			BA2037				20168	16,3 /S	LUC	
	1.8 GTI 16V		1G-KB075001		07.92										
	1.8 G 60			04.90	07.92			BA2038				20168	19,6 /S	LUC	
	1.8 Rallye			04.89	07.92										
	1.8 Syncro G 60			04.89	07.92										
		1.0	▶		19-E-855000	08.83			BAR10151				239	9,9 8,0	
1.0		▶			08.83	07.86									
1.0					08.86	10.91	- ABS								
1.3		▶		19-E-855000	08.83										
1.3		▶			08.83	07.86									
1.3					08.86	12.93	- ABS								
1.6			53		08.83	07.86									
1.6 D		▶		19-E-855000	08.83		- (⌚)								
1.6 D					08.83	07.86	- (⌚)								
1.6 D					08.86	07.92	+ Schaltgetriebe 1)								
1.0		▶	19-E-855001		08.89	10.91	+ ABS		BAR12106			239	12,0 10,0		
1.0					08.89	10.91	+ ABS								
1.3		▶	19-E-855001		08.89	12.93	+ ABS								
1.3					08.86	12.93									
1.6				08.86	12.93										
1.6		55		08.83	07.86										
1.6 D				08.83	07.86	+ (⌚)									
1.6 D	▶	19-E-855001		07.86	- (⌚)										
1.6 D				08.86	07.92	+ Automatikgetriebe 2)									
1.6 TD				08.83	12.93										
1.8		62		01.84	07.92	- ABS/ - GT									
1.8		66		01.84	07.92	- ABS/ - GT									
1.8 Syncro				08.85	07.92										
	1.8		62 19-JH560001		01.84	07.92		BAR20123				239	20,0 18,0 VL		
	1.8		66 19-JH560001		07.92	+ ABS									
	1.8		77		08.88	07.92	+ (⌚)								
	1.8 GT			08.85	07.92										
	1.8 GT Special			08.85	07.92										
	1.8 GTI			01.84	07.92										
	1.8 GTI 16V			1G-KW240000	02.86										
	1.8 GTI 16V			1G-KB075000	02.86										
	1.8 GTI 16V		1G-KW240001		07.92			BAR20128				256	20,0 18,0 VL		
	1.8 GTI 16V		1G-KB075001		07.92										
		1.0				08.83	10.91		BAH0010	2			L=310		
		1.3				08.83	12.93								
		1.6				08.83	12.93								
		1.6 D				08.83	07.92								
1.6 TD					08.83	12.93									
1.8					08.83	07.92									
1.8 GTI				1G-KW240000	01.84										
1.8 GTI				1G-KB075000	01.84										
1.8 GTI 16V				1G-KW240000	02.86										
1.8 GTI 16V				1G-KB075000	02.86										
1.8 G 60					04.90	07.92		BAH0014	2			L=330			
1.8 Rallye					04.89	07.92									
1.8 Syncro G 60					04.89	07.92									
		1.8		62 19-JH480001		07.92	+ ABS		BA2032				20961	15,2 /S	LUC
	1.8		66 19-JH480001		07.92	+ ABS									
	1.8 G 60			04.90	07.92										
	1.8 GT			08.85	07.92										
	1.8 GT Special			08.85	07.92										
	1.8 GTI			01.84	07.92										
	1.8 GTI 16V			02.86	07.92										
	1.8 Rallye			04.89	07.92										
	1.8 Syncro G 60			04.89	07.92										

1) + manual transmission / + scatola cambio velocità / + transmission mécanique / + cambio de velocidad  
2) + autom.transmission / + scatola cambio automatico / + transmission automatique / + cambio automático

**VOLKSWAGEN GOLF II (84-93)**

	1.8	62	19-JH480001			<b>07.92</b> + ABS	<b>BAR10111</b>	ohne Sensorring <sup>1)</sup>	226 10,0 8,0			
	1.8	66	19-JH480001			<b>07.92</b> + ABS						
	1.8 G 60					<b>04.90 07.92</b>						
	1.8 GT					<b>08.85 07.92</b>						
	1.8 GT Special					<b>08.85 07.92</b>						
	1.8 GTI					<b>01.84 07.92</b>						
	1.8 GTI 16V					<b>02.86 07.92</b>						
	1.8 Rallye					<b>04.89 07.92</b>						
1.8 Syncro G 60					<b>04.89 07.92</b>	<b>BAR10151</b>	239 9,9 8,0					
	1.0							<b>08.83 07.88</b>	<b>BAH0015</b>	2	L=180	
	1.3							<b>08.83 07.88</b>				
	1.6							<b>08.83 07.88</b>				
	1.6 D							<b>08.83 07.88</b>				
	1.6 TD							<b>08.83 07.88</b>				
	1.8	62						<b>01.84 07.88</b> - ABS				
	1.8	66						<b>01.84 07.88</b> - ABS				
	1.8 Rallye					<b>04.89 07.92</b>						
1.8 Syncro G 60					<b>04.89 07.92</b>	<b>BAH0011</b>	2	L=160				
1.0					<b>08.88 10.91</b>							
1.3					<b>08.88 12.93</b>							
1.6					<b>08.88 12.93</b>							
1.6 D					<b>08.88 07.92</b>							
1.6 TD					<b>08.88 12.93</b>							
1.8	62				<b>08.88 07.92</b> - ABS							
1.8	66				<b>08.88 07.92</b> - ABS							
	1.8	62	19-JH480001			<b>07.92</b> + ABS	<b>BAH0003</b>	2	L=160			
	1.8	66	19-JH480001			<b>07.92</b> + ABS						
	1.8 G 60					<b>04.90 07.92</b>						
	1.8 GT					<b>08.85 07.92</b>						
	1.8 GTI					<b>01.84 07.92</b>						
	1.8 GTI 16V					<b>02.86 07.92</b>						
	1.8 Syncro					<b>08.85 07.92</b>						
	1.0					<b>08.83 10.91</b> - Bremskraftregler <sup>2)</sup>				<b>BAW1401</b>	+ GG <sup>3)</sup>	Rz 14,29
1.3					<b>08.83 12.93</b> - Bremskraftregler <sup>2)</sup>							
1.6					<b>08.83 12.93</b> - Bremskraftregler <sup>2)</sup>							
1.6 D					<b>08.83 07.92</b> - Bremskraftregler <sup>2)</sup>							
1.6 TD					<b>08.83 12.93</b> - Bremskraftregler <sup>2)</sup>							
1.8	62				<b>01.84 07.92</b> - Bremskraftregler <sup>2)</sup>							
1.8	66				<b>01.84 07.92</b> - Bremskraftregler <sup>2)</sup>							
1.8	77	1G-KW593279			<b>08.88</b> +							
1.0					<b>08.83 10.91</b> + Bremskraftregler <sup>4)</sup>	<b>BAW1701</b>	+ GG <sup>3)</sup>	Rz 17,46				
1.3					<b>08.83 12.93</b> + Bremskraftregler <sup>4)</sup>							
1.6					<b>08.83 12.93</b> + Bremskraftregler <sup>4)</sup>							
1.6 D					<b>08.83 07.92</b> + Bremskraftregler <sup>4)</sup>							
1.6 TD					<b>08.83 12.93</b> + Bremskraftregler <sup>4)</sup>							
1.8	62				<b>01.84 07.92</b> + Bremskraftregler <sup>4)</sup>							
1.8	66				<b>01.84 07.92</b> + Bremskraftregler <sup>4)</sup>							
1.8	77	1G-KW593280			<b>07.92</b> +							
1.8 Syncro					<b>08.85 07.92</b>	<b>BAW1905</b>		Rz 19,05				
	1.0								<b>08.83 10.91</b>	<b>BAE5003</b>		180 x 31 HEB
	1.3								<b>08.83 12.93</b>			
	1.6								<b>08.83 12.93</b>			
	1.6 D								<b>08.83 07.92</b>			
	1.6 TD								<b>08.83 12.93</b> -			
	1.8	62							<b>01.84 07.92</b> - ABS			
	1.8	66							<b>01.84 07.92</b> - ABS			
	1.8	77				<b>08.88 07.92</b> - ABS +						
1.6 TD					<b>08.89 12.93</b> +	<b>BAE5001</b>		200 x 40 HEB	<b>VW</b>			
1.8	77				<b>08.88 07.92</b> + ABS +							
1.8 Syncro					<b>08.85 07.92</b>	<b>BAE5006</b>		230 x 40 HEB	<b>VW</b>			

**VOLKSWAGEN GOLF III (92-97)**

	1.4			1H-T-028354	<b>11.91</b>		<b>BA2132</b>		20887 19,7 +/Zub	<b>VW</b>
	1.6	55		1H-T-028354	<b>09.92</b>					
	1.8 CL/GL			1H-T-028354	<b>11.91</b>	+ Schaltgetriebe <sup>5)</sup>				
	1.8 CL/GL			1H-S-246940	<b>11.91</b>	+ Automatikgetriebe <sup>6)</sup>				
	1.8 Syncro			1H-S-089450	<b>01.93</b>	- ABS				
	1.9 D			1H-T-028354	<b>11.91</b>					
	1.9 D Ecomatic			1H-S-246940	<b>08.93</b>					
	1.9 SDI			1H-T-028354	<b>07.95</b>					
	1.9 TD	55		1H-T-028354	<b>11.91</b>					
	1.4		1H-T-028355			<b>08.97</b> - ABS				
1.6	55	1H-T-028355			<b>08.97</b> - ABS					
1.8 CL/GL		1H-T-028355			<b>08.97</b> - ABS/ + Schaltgetriebe <sup>7)</sup>					
1.9 D		1H-T-028355			<b>08.97</b> - ABS					
1.9 SDI		1H-T-028355			<b>08.97</b> - ABS					
1.9 TD	55	1H-T-028355			<b>08.97</b> - ABS	<b>BA2038</b>		20168 19,6 /S	<b>LUC</b>	
1.6 CL/GL	74				<b>07.94 08.97</b> - ABS					
1.8 CL/GL		1H-S-246941			<b>08.97</b> - ABS					
1.8 Syncro		1H-S-089451			<b>08.97</b> - ABS					
1.9 TDI	66				<b>10.93 04.96</b>					
1.9 TDI	81				<b>02.96 04.96</b> + roter Sattel <sup>8)</sup>					
1.9 TDI Syncro	66				<b>03.95 04.96</b>					
2.0 GTI	85	1H-S-560001			<b>04.96</b>					
2.0 GTI 16V		1H-S-560001			<b>04.96</b>					

<sup>1)</sup> without sensor ring / senza sensori / sans secours ABS / sin anillo sensor ABS

<sup>2)</sup> - brake pressure regulator / - correttore di frenata / - correcteur de freinage / - corrector de frenado

<sup>3)</sup> + cast iron / + ghisa / + fonte grise / + fundición de gris

<sup>4)</sup> + brake pressure regulator / + correttore di frenata / + correcteur de freinage / + corrector de frenado





<sup>5)</sup> + manual transmission / + scatola cambio velocità / + transmission mécanique / + cambio de velocidad

<sup>6)</sup> + autom.transmission / + scatola cambio automatico / + transmission automatique / + cambio automático

<sup>7)</sup> - ABS/ + manual transmission / - ABS/ + scatola camb.velocità / - ABS/ + transmission mécanique / - ABS/ + cambio de velocidad

<sup>8)</sup> + red caliper / + pinza rossa / + étrier rouge / + pinza roja

**VOLKSWAGEN GOLF III (92-97)**

	1.9 TDI	81		05.96	08.97 + roter Sattel <sup>1)</sup>	BA2333		21911 20,3 +	ATE				
	2.0 GTI	85		05.96	08.97								
	2.0 GTI 16V			05.96	08.97								
	2.8 VR6		1H-S-400001		08.97								
	2.9 VR6 Syncro			10.94	08.97								
	1.4			05.96	09.96 + ABS	BA2018		21945 16,3 /S	LUC				
	1.6	55		05.96	09.96 + ABS								
	1.6 GT	74		07.94	08.97								
	1.8			05.96	08.97 + ABS								
	1.8 GT			11.91	08.97								
	1.8 Syncro			01.93	08.97 + ABS								
	1.9 D			05.96	09.96 + ABS								
1.9 D Ecomatic		1H-S-246941		07.95									
1.9 SDI			05.96	09.96 + ABS									
1.9 TD	55		05.96	09.96 + ABS									
1.9 TDI	66		05.96	08.97									
1.9 TDI	81		02.96	08.97 - roter Sattel <sup>2)</sup>									
1.9 TDI Syncro	66		05.96	08.97									
2.0			11.91	08.97									
2.0 Syncro			07.95	08.97									
1.4			10.96	08.97 + ABS	BA2153		21866 15,3 +	VW					
1.6	55		10.96	08.97 + ABS									
1.9 D			10.96	08.97 + ABS									
1.9 SDI			10.96	08.97 + ABS									
1.9 TD	55		10.96	08.97 + ABS									
	1.4			11.91	08.97 - ABS	BAR12106		239 12,0 10,0					
	1.6	55		09.92	08.97 - ABS								
	1.8		1H-S-246940	11.91	- ABS/ - GT/+ Automatikgetriebe <sup>3)</sup>								
	1.8			11.91	- ABS/ - GT/+ Schaltgetriebe <sup>4)</sup>								
	1.8 Syncro		1H-S-089450	01.93	- ABS								
	1.9 D			11.91	08.97 - ABS								
	1.9 D Ecomatic		1H-S-246940	11.91									
	1.9 SDI			07.95	08.97 - ABS								
	1.9 TD	55		11.91	08.97 - ABS								
	1.6 CL/GL	74		07.94	08.97 - ABS					BAR13178		256 12,9 11,0	
	1.8		1H-S-246941		08.97 - ABS/+ Automatikgetriebe <sup>5)</sup>								
	1.8 Syncro		1H-S-089451		08.97 - ABS								
1.9 TDI	66		10.93	04.96									
1.9 TDI Syncro	66		03.95	04.96									
1.4			05.96	09.96 + ABS	BAR20128		256 20,0 18,0 V L						
1.6	55		05.96	09.96 + ABS									
1.6 GT	74		07.94	08.97									
1.8			05.96	08.97 + ABS									
1.8 GT			11.91	08.97 + ABS									
1.8 Syncro			01.93	08.97 + ABS									
1.9 D			05.96	09.96 + ABS									
1.9 D Ecomatic		1H-S-246941		07.95									
1.9 SDI			05.96	09.96 + ABS									
1.9 TD	55		05.96	09.96 + ABS									
1.9 TDI	66		05.96	08.97									
1.9 TDI	81		02.96	08.97 - roter Sattel <sup>2)</sup>									
1.9 TDI Syncro	66		05.96	08.97									
2.0			11.91	08.97									
2.0 Syncro			07.95	08.97									
1.4			10.96	08.97 + ABS	BAR20123		239 20,0 18,0 V L						
1.6	55		10.96	08.97 + ABS									
1.9 D			10.96	08.97 + ABS									
1.9 SDI			10.96	08.97 + ABS									
1.9 TD	55		10.96	08.97 + ABS									
1.9 TDI	81		02.96	04.96 + roter Sattel <sup>1)</sup>	BAR22100	für 5-Loch-Felge <sup>6)</sup>	280 22,0 20,0 V L						
2.0 GTI	85		11.91	04.96									
2.0 GTI 16V			08.92	04.96									
2.8 VR6		1H-S-399999	01.92										
	1.4			11.91	08.97	BAH0005	2	L=435					
	1.6			09.92	08.97								
	1.8			11.91	08.97								
	1.8 Syncro			01.93	08.97								
	1.9 D			11.91	08.97								
	1.9 D Ecomatic			08.93	07.95								
	1.9 SDI			07.95	08.97								
	1.9 TD	55		11.91	08.97								
	1.9 TDI	66		10.93	08.97								
	1.9 TDI Syncro	66		03.95	08.97								
	2.0			11.91	08.97								
	2.0 Syncro			07.95	08.97								
2.8 VR6			01.92	02.95									
	1.8 GT			11.91	08.97	BA2032		20961 15,2 /S	LUC				
	2.0 GL			11.91	08.97								
	2.0 GTI	85	1H-P-240000	11.91									
	2.0 GTI 16V		1H-P-240000	11.91									
	2.8 VR6		1H-P-240000	01.92									
1.6 GT	74		07.94	08.97	BA2017		20961 17,2 /S	LUC					
1.9 TDI	81		02.96	08.97									
2.0 GTI	85	1H-P-240001		08.97									
2.0 GTI 16V		1H-P-240001		08.97									
2.8 VR6		1H-P-240001		08.97									

<sup>1)</sup> + red caliper / + pinza rossa / + étrier rouge / + pinza roja















<sup>2)</sup> - red caliper / - pinza rossa / - étrier rouge / - pinza roja

<sup>3)</sup> - ABS/ - GT/ + autom.transm. / - ABS/ - GT/+ scatola camb.autom. / - ABS/ - GT/ + transmiss. automatique / - ABS/ - GT/ + cambio automático

<sup>4)</sup> - ABS/ - GT/ + manual transm. / - ABS/ - GT/+ scatola camb.velocità / - ABS/ - GT/ + transmiss. mécanique / - ABS/ - GT/ + cambio de velocidad

<sup>5)</sup> - ABS/ + autom.transmission / - ABS/ + scatola cambio autom. / - ABS/ + transmission automatique / - ABS/ + cambio automático

<sup>6)</sup> for 5 bore wheel rim / per cerchione a 5 fori / pour jante à 5 trous / para Llantas de 5 taladros

								
<b>VOLKSWAGEN GOLF III (92-97)</b>								
	2.9 VR6 Syncro			10.94 08.97		BA2017		20961 17,2 /S LUC
	1.6 GT	74		07.94 08.97		BAR10111	für 4-Loch-Felge/- Sensorring <sup>1)</sup>	226 10,0 8,0
	1.8 GT			11.91 08.97				
	1.9 TDI	81		02.96 08.97	- roter Sattel <sup>2)</sup>			
	2.0 GL	85		11.91 08.97				
	1.9 TDI	81		02.96 08.97	+ roter Sattel <sup>3)</sup>	BAR10203		226 10,0 8,0
	2.0 GTI	85		11.91 08.97				
	2.0 GTI 16V			08.92 08.97				
	2.8 VR6			01.92 08.97				
	1.4			11.91 08.97		BAH0016	2	L=135
	1.6			09.92 08.97	- GT			
	1.8			11.91 08.97	- GT			
	1.8 Syncro			01.93 08.97				
	1.9 D			11.91 08.97				
	1.9 D Ecomatic			08.93 07.95				
	1.9 SDI			07.95 08.97				
	1.9 TD	55		11.91 08.97				
	1.9 TDI	66		10.93 08.97				
	1.9 TDI Syncro	66		03.95 08.97				
	2.0 Syncro			07.95 08.97				
		1.6 GT	74		07.94 08.97		BAH0016 BAH0003	2 2
	1.8 GT			11.91 08.97				
	1.9 TDI	81		02.96 08.97				
	2.0			11.91 08.97				
	2.0 GTI	85		11.91 08.97				
	2.0 GTI 16V			08.92 08.97				
	2.8 VR6			01.92 08.97				
	2.9 VR6 Syncro			10.94 08.97				
	1.4			11.91 08.97		BAW1501		+ GG <sup>5)</sup>
	1.8 CL/GL		1H-S-246940	11.91	+ Automatikgetriebe <sup>6)</sup>			
	1.9 D Ecomatic		1H-S-246940	08.93				
	1.9 TD	55		11.91 08.97				
	1.6	55		09.92 08.97		BAW1701		+ GG <sup>5)</sup>
	1.6 CL/GL	74	1H-S-246940	07.94	+ Schaltgetriebe <sup>7)</sup>			
	1.6 CL/GL	74		07.94 08.97	+ Automatikgetriebe <sup>6)</sup>			
	1.8 CL/GL		1H-S-246940	11.91	+ Schaltgetriebe <sup>7)</sup>			
	1.8 CL/GL	1H-S-246941		08.97	+ Automatikgetriebe <sup>6)</sup>			
	1.9 D			11.91 08.97				
1.9 D Ecomatic		1H-S-246941	07.95					
1.9 SDI			07.95 08.97					
1.9 TDI	66		10.93 08.97					
	1.6 CL/GL	74	1H-S-246941	08.97	+ Schaltgetriebe <sup>7)</sup>	BAW1905		Rz 19,05
	1.8 CL/GL		1H-S-246941	08.97	+ Schaltgetriebe <sup>7)</sup>			
	1.8 Syncro		1H-S-400000	01.93		BAW2004		Rz 20,64
	1.4			11.91 08.97		BAE5001		200 x 40 HEB VW
	1.6	55		09.92 08.97				
	1.6 CL/GL			09.92 08.97				
	1.8 CL/GL			11.91 08.97				
	1.9 D			11.91 08.97				
	1.9 D Ecomatic			08.93 07.95				
	1.9 SDI			07.95 08.97				
	1.9 TD	55		11.91 08.97				
	1.9 TDI	66		10.93 08.97				
		1.8 Syncro			01.93 08.97		BAE5006	
	1.9 TDI Syncro	66		03.95 08.97				
	2.0 Syncro			07.95 08.97				
<b>VOLKSWAGEN GOLF III Variant (93-99)</b>								
	1.4		1H-TB015953	07.93		BA2132		20887 19,7 +/Zub VW
	1.8 Syncro		1H-SW369000	07.94				
	1.4		1H-TB015954	04.96		BA2145		21866 19,7 + VW
	1.4			05.96 04.99	- ABS			
	1.6	55		07.94 04.96		BA2038		20168 19,6 /S LUC
	1.6	55		05.96 04.99	- ABS			
	1.6	74		07.94 04.96				
	1.8			07.93 04.96				
	1.8			05.96 04.99	- ABS			
	1.8 Syncro		1H-SW369001	04.99				
	1.9 D			07.93 04.96				
	1.9 D			05.96 04.99	- ABS			
	1.9 SDI			07.95 04.96				
	1.9 SDI			05.96 04.99	- ABS			
	1.9 TD	55		07.93 04.96				
	1.9 TD	55		05.96 04.99	- ABS			
	1.9 TDI	66		07.93 04.96				
	1.9 TDI	66		05.96 04.99	- ABS			
	1.9 TDI Syncro	66		07.95 04.99				
	1.4			05.96 09.96	+ ABS	BA2018		21945 16,3 /S LUC
	1.6	55		05.96 09.96	+ ABS			
	1.6	74		05.96 04.99				
	1.8			05.96 04.99	+ ABS			
	1.9 D			05.96 09.96	+ ABS			
	1.9 SDI			05.96 09.96	+ ABS			

<sup>1)</sup> for 4-hole rim/-sensor ring / per cerch.4 fori/-sensore ruota / pour jante 4 trous/-roue codeuse / para llanta cuatro agujeros/-anillo sensor

<sup>2)</sup> - red caliper / - pinza rossa / - étrier rouge / - pinza roja















<sup>3)</sup> + red caliper / + pinza rossa / + étrier rouge / + pinza roja

<sup>4)</sup> on the brake caliper / sulla pinza freno / sur l'étrier de frein / a la pinza de freno

<sup>5)</sup> + cast iron / + ghisa / + fonte grise / + fundición de gris

























<sup>6)</sup> + autom.transmission / + scatola cambio automatico / + transmission automatique / + cambio automático

<sup>7)</sup> + manual transmission / + scatola cambio velocità / + transmission mécanique / + cambio de velocidad

									
<b>VOLKSWAGEN GOLF III Variant (93-99)</b>									
	1.9 TD			05.96	09.96 + ABS	BA2018		21945 16,3 / S	LUC
	1.9 TDI	66		05.96	04.99 + ABS				
	1.9 TDI	81		02.96	04.99				
	2.0			07.93	04.99				
2.0 Syncro			07.95	04.99					
	1.4			10.96	04.99 + ABS	BA2153		21866 15,3 +	VW
	1.6	55		10.96	04.99 + ABS				
	1.9 D			10.96	04.99 + ABS				
	1.9 SDI			10.96	04.99 + ABS				
	1.9 TD			10.96	04.99 + ABS				
2.9 VR6 Syncro			07.95	04.99	BA2333		21911 20,3 +	ATE	
	1.4			07.93	04.96	BAR12106		239 12,0 10,0	
	1.4			05.96	04.99 - ABS				
	1.8 Syncro		1H-SW369000	07.94					
	1.6	55		07.94	04.96	BAR13178		256 12,9 11,0	
	1.6	55		05.96	04.99 - ABS				
	1.6	74		07.94	04.96				
	1.8			07.93	04.96				
	1.8			05.96	04.99 - ABS				
	1.8 Syncro		1H-SW369001		04.99				
	1.9 D			07.93	04.96				
	1.9 D			05.96	04.99 - ABS				
	1.9 SDI			07.95	04.96				
	1.9 SDI			05.96	04.99 - ABS				
	1.9 TD	55		07.93	04.96				
	1.9 TD	55		05.96	04.99 - ABS				
	1.9 TDI	66		07.93	04.96				
	1.9 TDI	66		05.96	04.99 - ABS				
	1.9 TDI Syncro	66		07.95	04.99				
	1.4			05.96	09.96 + ABS	BAR20128		256 20,0 18,0 V L	
1.6	55		05.96	09.96 + ABS					
1.6	74		05.96	04.99					
1.8			05.96	04.99 + ABS					
1.9 D			05.96	09.96 + ABS					
1.9 SDI			05.96	09.96 + ABS					
1.9 TD	55		05.96	09.96 + ABS					
1.9 TDI	66		05.96	04.99 + ABS					
1.9 TDI	81		02.96	04.99					
2.0			07.93	04.99					
2.0 Syncro			07.95	04.99					
1.4			10.96	04.99 + ABS	BAR20123		239 20,0 18,0 V L		
1.6	55		10.96	04.99 + ABS					
1.9 D			10.96	04.99 + ABS					
1.9 SDI			10.96	04.99 + ABS					
1.9 TD	55		10.96	04.99 + ABS					
	1.4			07.93	04.99	BAH0005	2	L=435	
	1.6			07.94	04.99				
	1.8			07.93	04.99				
	1.8 Syncro			07.94	04.99				
	1.9 D			07.93	04.99				
	1.9 SDI			07.95	04.99				
	1.9 TD	55		07.93	04.99				
	1.9 TDI	66		07.93	04.99				
	1.9 TDI	81		02.96	04.99				
	1.9 TDI Syncro	66		07.95	04.99				
	2.0			07.93	04.99				
2.0 Syncro			07.95	04.99					
2.9 VR6 Syncro			07.95	04.99	BA2017		20961 17,2 / S	LUC	
	1.4			07.93	04.99	BAH0016	2	L=135	
	1.6			07.94	04.99				
	1.8			07.93	04.99				
	1.8 Syncro			07.94	04.99				
	1.9 D			07.93	04.99				
	1.9 SDI			07.95	04.99				
	1.9 TD	55		07.93	04.99				
	1.9 TDI	66		07.93	04.99				
	1.9 TDI	81		02.96	04.99				
	1.9 TDI Syncro	66		07.95	04.99				
2.0			07.93	04.99					
2.0 Syncro			07.95	04.99					
2.9 VR6 Syncro			07.95	04.99	BAH0016	2	L=135		
					BAH0003	2	L=160		
	1.4			07.93	06.95	BAW1701		Rz 17,46	
	1.4			07.95	04.99	BAW1905		Rz 19,05	
	1.6			07.94	04.99				
	1.8			07.93	04.99				
	1.9 D			07.93	04.99				
	1.9 SDI			07.95	04.99				
	1.9 TD	55		07.93	04.99				
	1.9 TDI	66		07.93	04.99				
1.9 TDI	81		02.96	04.99					
2.0			07.93	04.99					

1) on the brake caliper / sulla pinza freno / sur l'étrier de frein / a la pinza de freno





2) + cast iron / + ghisa / + fonte grise / + fundición de gris













									
<b>VOLKSWAGEN GOLF III Variant (93-99)</b>									
	1.4			07.93	04.99	BAE5001		200 x 40 HEB	VW
	1.6			07.94	04.99				
	1.8			07.93	04.99				
	1.9 D			07.93	04.99				
	1.9 SDI			07.95	04.99				
	1.9 TD	55		07.93	04.99				
	1.9 TDI	66		07.93	04.99				
	1.9 TDI	81		02.96	04.99				
	2.0			07.93	04.99				
	1.8 Syncro			07.94	04.99		BAE5006		
1.9 TDI Syncro	66		07.95	04.99					
2.0 Syncro			07.95	04.99					
<b>VOLKSWAGEN GOLF III Cabriolet (94-02)</b>									
	1.6		1E-T-030000	10.94		BA2038		20168 19,6 /S	LUC
	1.8	55	1E-T-030000	09.93					
	1.8	66	1E-T-030000	09.93					
	1.9 TDI	66	1E-T-030000	08.95					
	2.0								
	1.6		1E-V-000001	02.02		BA2018		21945 16,3 /S	LUC
	1.8	55	1E-V-000001	02.02					
	1.8	66	1E-V-000001	02.02					
	1.9 TDI	66	1E-V-000001	02.02					
	1.9 TDI	81		09.96	02.02				
	2.0			09.93	02.02				
	1.6		1E-T-030000	10.94		BAR13178		256 12,9 11,0	
	1.8	55	1E-T-030000	09.93					
	1.8	66	1E-T-030000	09.93					
	1.9 TDI	66	1E-T-030000	08.95					
	2.0								
	1.6		1E-V-000001	02.02		BAR20128		256 20,0 18,0 V L	
	1.8	55	1E-V-000001	02.02					
	1.8	66	1E-V-000001	02.02					
	1.9 TDI	66	1E-V-000001	02.02					
	1.9 TDI	81		09.96	02.02				
	2.0			09.93	02.02				
	1.6			10.94	02.02	BAH0005	2	L=435	
	1.8			09.93	02.02				
	1.9 TDI	66		08.95	02.02				
	1.9 TDI	81		09.96	02.02				
	2.0			09.93	02.02				
	1.6		1E-X-016000	04.98		BA2032		20961 15,2 /S	LUC
	1.8		1E-X-016000	04.98					
	1.9 TDI	66	1E-X-016000	04.98					
	1.9 TDI	81	1E-X-016000	09.96					
	2.0		1E-X-016000	04.98					
	1.6		1E-X-016001	02.02		BA2017		20961 17,2 /S	LUC
	1.8		1E-X-016001	02.02					
	1.9 TDI	66	1E-X-016001	02.02 + ABS					
	1.9 TDI	81	1E-X-016001	02.02 + ABS					
	2.0		1E-X-016001	02.02					
	1.9 TDI	66	1E-X-016001	02.02	- ABS	BA2032		20961 15,2 /S	LUC
	1.9 TDI	81	1E-X-016001	02.02	- ABS				
	1.6			04.98	02.02	BAR10111	ohne Sensorring <sup>1)</sup>	226 10,0 8,0	
	1.8			04.98	02.02				
	1.9 TDI	66		04.98	02.02				
	1.9 TDI	81		09.96	02.02				
	2.0			04.98	02.02				
	1.6			10.94	02.02	BAH0016	2	L=135	
	1.8			09.93	02.02				
	1.9 TDI	66		08.95	02.02				
	1.9 TDI	81	1E-X-016000	09.96					
	2.0		1E-X-016000	09.93					
	1.9 TDI	81	1E-X-016001	02.02		BAH0016	2	L=135	
	2.0		1E-X-016001	02.02					
	1.6		1E-SK016363	10.94		BAW1701	+ GG <sup>3)</sup>	Rz 17,46	
	1.8		1E-SK016363	09.93					
	1.9 TDI	66	1E-SK016363	08.95					
	2.0		1E-SK016363	09.93					
	1.6		1E-SK016364	03.98		BAW1905		Rz 19,05	
	1.8		1E-SK016364	03.98					
	1.9 TDI	66	1E-SK016364	03.98					
	2.0		1E-SK016364	03.98					
	1.6			10.94	03.98	BAE5001		200 x 40 HEB	VW
	1.8			09.93	03.98				
	1.9 TDI	66		08.95	03.98				
	2.0			09.93	03.98				
<b>VOLKSWAGEN GOLF IV (98-03)</b>									
	1.4		1J-X-800000	10.97	PR: 1LQ,1LR,1ZF	BA2154		23130 19,6 +	VW
	1.6		1J-X-800000	10.97	PR: 1LQ,1LR,1ZF				
	1.8	92	1J-X-800000	10.97	PR: 1LQ,1LR,1ZF				
	1.9 SDI		1J-X-800000	10.97	PR: 1LQ,1LR,1ZF				
	1.9 TDI	66	1J-X-800000	10.97	PR: 1LQ,1LR,1ZF				
	1.9 TDI	74	1J-X-800000	09.00	PR: 1LQ,1LR,1ZF				
	1.9 TDI	81	1J-X-800000	10.97	PR: 1LQ,1LR,1ZF				
	1.9 TDI	85	1J-X-800000	05.99	PR: 1LQ,1LR,1ZF				













1) without sensor ring / senza sensori / sans secours ABS / sin anillo sensor ABS  
2) on the brake caliper / sulla pinza freno / sur l'étrier de frein / a la pinza de freno  
3) + cast iron / + ghisa / + fonte grise / + fundición de gris













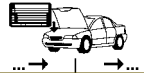

**VOLKSWAGEN GOLF IV (98-03)**



	1.4	1J-Y-000001		10.03	PR: 1LS,1ZM	BA2155		23131 19,6 +WK	WW						
	1.6	1J-Y-000001		10.03	PR: 1LS,1ZM										
	1.6 FSI		01.02	10.03	PR: 1LS,1ZM										
	1.8	92 1J-Y-000001		10.03	PR: 1LS,1ZM										
	1.8 4motion	92		07.98	10.03					PR: 1LS,1ZM					
	1.9 SDI	1J-Y-000001		10.03	PR: 1LS,1ZM										
	1.9 TDI	66 1J-Y-000001		06.01	PR: 1LS,1ZM										
	1.9 TDI	74 1J-Y-000001		10.03	PR: 1LS,1ZM										
	1.9 TDI	81 1J-Y-000001		10.03	PR: 1LS,1ZM										
	1.9 TDI	85 1J-Y-000001		06.01	PR: 1LS,1ZM										
	1.9 TDI 4motion	66		07.98	06.01					PR: 1LS,1ZM					
	1.9 TDI 4motion	74		09.00	10.03					PR: 1LS,1ZM					
	1.9 TDI 4motion	85		11.99	06.01					PR: 1LS,1ZM					
	2.0	85		08.98	10.03					PR: 1LS,1ZM					
	2.0 4motion	85		04.00	10.03					PR: 1LS,1ZM					
1.8 T GTI			10.97	10.03	BA2333		21911 20,3 +	ATE							
2.3 V5	1J-X-800000		10.97	PR: 1LE,1LN,1ZE,1ZH											
2.3 V5 4motion	1J-X-800000		11.98	PR: 1LE,1LN,1ZE,1ZH											
2.8 V6 4motion	1J-X-800000		01.99	PR: 1LE,1LN,1ZE,1ZH											
	1.9 TDI	96		04.01	10.03	BA2205		23392 20,6 +WK	ATE						
	1.9 TDI	110		09.00	10.03					PR: 1LJ,1ZQ					
	1.9 TDI 4motion	96		04.01	10.03					PR: 1LJ,1ZQ					
	1.9 TDI 4motion	110		09.00	10.03					PR: 1LJ,1ZQ					
	2.3 V5	1J-Y-000001		10.03	PR: 1LJ,1ZQ										
	2.3 V5 4motion	1J-Y-000001		10.03	PR: 1LJ,1ZQ										
	2.8 V6 4motion	1J-Y-000001		10.03	PR: 1LJ,1ZQ										
		1.4			10.97					10.03	BAR22151		256 22,0 19,0 V L		
		1.6			10.97					10.03					PR: 1LQ,1ZF
		1.6 FSI			01.02					10.03					PR: 1LQ,1ZF
		1.8	92		10.97					10.03					PR: 1LQ,1ZF
		1.8 4motion	92		07.98					10.03					PR: 1LQ,1ZF
		1.9 TDI	66		10.97					06.01					PR: 1LQ,1ZF
		1.9 TDI	74		09.00					10.03					PR: 1LQ,1ZF
		1.9 TDI	81		10.97					10.03					PR: 1LQ,1ZF
1.9 TDI		85		05.99	06.01	PR: 1LQ,1ZF									
1.9 TDI		96		04.01	10.03	PR: 1LQ,1ZF									
1.9 TDI		110		09.00	10.03	PR: 1LQ,1ZF									
1.9 TDI 4motion		66		07.98	06.01	PR: 1LQ,1ZF									
1.9 TDI 4motion		74		09.00	10.03	PR: 1LQ,1ZF									
1.9 TDI 4motion		85		11.99	06.01	PR: 1LQ,1ZF									
1.9 TDI 4motion		96		04.01	10.03	PR: 1LQ,1ZF									
1.9 TDI 4motion	110		09.00	10.03	PR: 1LQ,1ZF										
2.0	85		08.98	10.03	PR: 1LQ,1ZF										
2.0 4motion	85		04.00	10.03	PR: 1LQ,1ZF										
2.3 V5			10.97	10.03	PR: 1LQ,1ZF										
2.3 V5 4motion			11.98	10.03	PR: 1LQ,1ZF										
	1.4			10.97	10.03	BAR22150		280 22,0 19,0 V L							
	1.6			10.97	10.03					PR: 1LR,1LS,1ZM					
	1.6 FSI			01.02	10.03					PR: 1LR,1LS,1ZM					
	1.8	92		10.97	10.03					PR: 1LR,1LS,1ZM					
	1.8 4motion	92		07.98	10.03					PR: 1LR,1LS,1ZM					
	1.9 TDI	66		10.97	06.01					PR: 1LR,1LS,1ZM					
	1.9 TDI	74		09.00	10.03					PR: 1LR,1LS,1ZM					
	1.9 TDI	81		10.97	10.03					PR: 1LR,1LS,1ZM					
	1.9 TDI	85		05.99	06.01					PR: 1LR,1LS,1ZM					
	1.9 TDI	96		04.01	10.03					PR: 1LR,1LS,1ZM					
	1.9 TDI	110		09.00	10.03					PR: 1LR,1LS,1ZM					
	1.9 TDI 4motion	66		07.98	06.01					PR: 1LR,1LS,1ZM					
	1.9 TDI 4motion	74		09.00	10.03					PR: 1LR,1LS,1ZM					
	1.9 TDI 4motion	85		11.99	06.01					PR: 1LR,1LS,1ZM					
	1.9 TDI 4motion	96		04.01	10.03					PR: 1LR,1LS,1ZM					
1.9 TDI 4motion	110		09.00	10.03	PR: 1LR,1LS,1ZM										
2.0	85		08.98	10.03	PR: 1LR,1LS,1ZM										
2.0 4motion	85		04.00	10.03	PR: 1LR,1LS,1ZM										
2.3 V5			10.97	10.03	PR: 1LR,1LS,1ZM										
2.3 V5 4motion			11.98	10.03	PR: 1LR,1LS,1ZM										
	1.4			10.97	10.03	BAR25113		288 25,0 22,0 V L							
	1.6			10.97	10.03					PR: 1LE,1LN,1ZE,1ZH					
	1.6 FSI			01.02	10.03					PR: 1LE,1LN,1ZE,1ZH					
	1.8	92		10.97	10.03					PR: 1LE,1LN,1ZE,1ZH					
	1.8 4motion	92		10.97	06.01					PR: 1LE,1LN,1ZE,1ZH					
	1.9 TDI	66		10.97	06.01					PR: 1LE,1LN,1ZE,1ZH					
	1.9 TDI	74		09.00	10.03					PR: 1LE,1LN,1ZE,1ZH					
	1.9 TDI	81		10.97	10.03					PR: 1LE,1LN,1ZE,1ZH					
	1.9 TDI	85		05.99	06.01					PR: 1LE,1LN,1ZE,1ZH					
	1.9 TDI	96		04.01	10.03					PR: 1LE,1LN,1ZE,1ZH					
	1.9 TDI	110		09.00	10.03					PR: 1LE,1LN,1ZE,1ZH					
	1.9 TDI 4motion	66		07.98	06.01					PR: 1LE,1LN,1ZE,1ZH					
	1.9 TDI 4motion	74		09.00	10.03					PR: 1LE,1LN,1ZE,1ZH					
	1.9 TDI 4motion	85		11.99	06.01					PR: 1LE,1LN,1ZE,1ZH					
	1.9 TDI 4motion	96		04.01	10.03					PR: 1LE,1LN,1ZE,1ZH					
1.9 TDI 4motion	110		09.00	10.03	PR: 1LE,1LN,1ZE,1ZH										
2.0	85		08.98	10.03	PR: 1LE,1LN,1ZE,1ZH										
2.0 4motion	85		04.00	10.03	PR: 1LE,1LN,1ZE,1ZH										
2.3 V5			10.97	10.03	PR: 1LE,1LN,1ZE,1ZH										
2.3 V5 4motion			11.98	10.03	PR: 1LE,1LN,1ZE,1ZH										



								
<b>VOLKSWAGEN GOLF IV (98-03)</b>								
	2.8 V6 4motion		01.99	10.03	PR: 1LJ,1ZQ	BAR25123		312 25,0 23,0 V L
	1.4		10.97	10.03		BAH0023	2	L=435
	1.6		10.97	10.03				
	1.6 FSI		01.02	10.03				
	1.8	92	10.97	10.03				
	1.8 T GTI		10.97	10.03				
	1.9 SDI		10.97	10.03				
	1.9 TDI	66	10.97	06.01				
	1.9 TDI	74	09.00	10.03				
	1.9 TDI	81	10.97	10.03				
	1.9 TDI	85	05.99	06.01				
	1.9 TDI	96	04.01	10.03				
	1.9 TDI	110	09.00	10.03				
	2.0	85	08.98	10.03				
	2.3 V5		10.97	10.03				
	1.4		10.97	10.03	PR: 1KK,1KS,1KV	BA2017		20961 17,2 /S LUC
	1.6		10.97	10.03	PR: 1KK,1KS,1KV			
	1.6 FSI		01.02	10.03	PR: 1KK,1KS,1KV			
	1.8	92	10.97	10.03	PR: 1KK,1KS,1KV			
	1.8 4motion	92	07.98	10.03	PR: 1KE			
	1.9 SDI		10.97	10.03	PR: 1KK,1KS,1KV			
	1.9 TDI	66	10.97	06.01	PR: 1KK,1KS,1KV			
	1.9 TDI	74	09.00	10.03	PR: 1KK,1KS,1KV			
	1.9 TDI	81	10.97	10.03	PR: 1KK,1KS,1KV			
	1.9 TDI	85	05.99	06.01	PR: 1KK,1KS,1KV			
	1.9 TDI	96	04.01	10.03	PR: 1KK,1KS,1KV			
	1.9 TDI	110	09.00	10.03	PR: 1KK,1KS,1KV			
	1.9 TDI 4motion	66	07.98	06.01	PR: 1KE			
	1.9 TDI 4motion	74	09.00	10.03	PR: 1KE			
	1.9 TDI 4motion	85	11.99	06.01	PR: 1KE			
	1.9 TDI 4motion	96	04.01	10.03	PR: 1KE			
	1.9 TDI 4motion	110	09.00	10.03	PR: 1KE			
	2.0	85	08.98	10.03	PR: 1KK,1KS,1KV			
	2.0 4motion	85	04.00	10.03	PR: 1KE			
	2.3 V5		10.97	10.03	PR: 1KK,1KS,1KV			
	2.3 V5 4motion		11.98	10.03	PR: 1KE			
	2.8 V6 4motion		01.99	10.03	PR: 1KE			
	3.2 R32 4motion		06.02	10.03	PR: 1KE			
	1.4		10.97	10.03	PR: 1KY	BA2032		20961 15,2 /S LUC
	1.6		10.97	10.03	PR: 1KY			
	1.6 FSI		01.02	10.03	PR: 1KY			
	1.8	92	10.97	10.03	PR: 1KY			
	1.8 4motion	92	07.98	10.03	PR: 1KU,2EE,2EL			
	1.8 T GTI		10.97	10.03				
	1.9 SDI		10.97	10.03	PR: 1KY			
	1.9 TDI	66	10.97	06.01	PR: 1KY			
	1.9 TDI	74	09.00	10.03	PR: 1KY			
	1.9 TDI	81	10.97	10.03	PR: 1KY			
	1.9 TDI	85	05.99	06.01	PR: 1KY			
	1.9 TDI	96	04.01	10.03	PR: 1KY			
	1.9 TDI	110	09.00	10.03	PR: 1KY			
	1.9 TDI 4motion	66	07.98	06.01	PR: 1KU,2EE,2EL			
	1.9 TDI 4motion	74	09.00	10.03	PR: 1KU,2EE,2EL			
	1.9 TDI 4motion	85	11.99	06.01	PR: 1KU,2EE,2EL			
	1.9 TDI 4motion	96	04.01	10.03	PR: 1KU,2EE,2EL			
	1.9 TDI 4motion	110	09.00	10.03	PR: 1KU,2EE,2EL			
	2.0	85	08.98	10.03	PR: 1KY			
	2.0 4motion	85	04.00	10.03	PR: 1KU,2EE,2EL			
	2.3 V5		10.97	10.03	PR: 1KY			
	2.3 V5 4motion		11.98	10.03	PR: 1KU,2EE,2EL			
	2.8 V6 4motion		01.99	10.03	PR: 1KU,2EE,2EL			
	3.2 R32 4motion		06.02	10.03	PR: 1KU,2EE,2EL			
	1.4		10.97	10.03	PR: 1KK	BAR09123		232 8,9 7,0
	1.6		10.97	10.03	PR: 1KK			
	1.6 FSI		01.02	10.03	PR: 1KK			
	1.8	92	10.97	10.03	PR: 1KK			
	1.9 SDI		10.97	10.03	PR: 1KK			
	1.9 TDI	66	10.97	06.01	PR: 1KK			
	1.9 TDI	74	09.00	10.03	PR: 1KK			
	1.9 TDI	81	10.97	10.03	PR: 1KK			
	1.9 TDI	85	05.99	06.01	PR: 1KK			
	1.9 TDI	96	04.01	10.03	PR: 1KK			
	1.9 TDI	110	09.00	10.03	PR: 1KK			
	2.0	85	08.98	10.03	PR: 1KK			
	2.3 V5		10.97	10.03	PR: 1KK			
	1.8 4motion	92	07.98	10.03	PR: 1KE	BAR09133		239 8,9 7,0
	1.9 TDI 4motion	66	07.98	06.01	PR: 1KE			
	1.9 TDI 4motion	74	09.00	10.03	PR: 1KE			
	1.9 TDI 4motion	85	11.99	06.01	PR: 1KE			
	1.9 TDI 4motion	96	04.01	10.03	PR: 1KE			
	1.9 TDI 4motion	110	09.00	10.03	PR: 1KE			
	2.0 4motion	85	04.00	10.03	PR: 1KE			
	2.3 V5 4motion		11.98	10.03	PR: 1KE			
	2.3 V5 4motion		11.98	10.03	PR: 1KU,2EE,2EL	BAR22163		256 22,0 20,0 V L











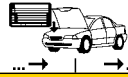

								
<b>VOLKSWAGEN GOLF IV (98-03)</b>								
	2.8 V6 4motion 3.2 R32 4motion		01.99 06.02	10.03 10.03	PR: 1KU,2EE,2EL PR: 1KU,2EE,2EL	BAR22163		256 22,0 20,0 V L
	1.4 1.6 1.6 FSI 1.8 1.8 T GTI 1.9 SDI 1.9 TDI 1.9 TDI 1.9 TDI 1.9 TDI 1.9 TDI 2.0 2.3 V5	92 66 74 81 85 96 110 85	10.97 10.97 01.02 10.97 10.97 10.97 09.00 10.97 05.99 04.01 09.00 08.98 10.97	10.03 10.03 10.03 10.03 10.03 10.03 10.03 10.03 06.01 10.03 10.03 10.03 10.03	PR: 1KY PR: 1KY PR: 1KY PR: 1KY PR: 1KY PR: 1KY PR: 1KY PR: 1KY PR: 1KY PR: 1KY PR: 1KY PR: 1KY	BAR22163		256 22,0 20,0 V L
	1.4 1.6 1.6 FSI 1.8 1.8 T GTI 1.9 SDI 1.9 TDI 1.9 TDI 1.9 TDI 1.9 TDI 1.9 TDI 2.0 2.3 V5	92 66 74 81 85 96 110 85	10.97 10.97 01.02 10.97 10.97 10.97 09.00 10.97 05.99 04.01 09.00 08.98 10.97	10.03 10.03 10.03 10.03 10.03 10.03 10.03 10.03 06.01 10.03 10.03 10.03 10.03		BAH0033	2	L=140
	1.8 4motion 1.9 TDI 4motion 1.9 TDI 4motion 1.9 TDI 4motion 1.9 TDI 4motion 1.9 TDI 4motion 2.0 4motion 2.3 V5 4motion 2.8 V6 4motion 3.2 R32 4motion	92 66 74 85 96 110 85	07.98 07.98 09.00 11.99 04.01 09.00 04.00 11.98 01.99 06.02	10.03 10.03 10.03 06.01 10.03 10.03 10.03 10.03 10.03 10.03		BAH0033	2	L=140
<b>VOLKSWAGEN GOLF IV Variant (99-06)</b>								
	1.4 1.6 1.6 FSI 1.8 4motion 1.9 SDI 1.9 TDI 1.9 TDI 1.9 TDI 1.9 TDI 4motion 1.9 TDI 4motion 1.9 TDI 4motion 2.0 2.0 4motion	92 66 74 81 85 66 74 85 85 85	05.99 05.99 01.02 05.99 05.99 09.00 05.99 05.99 09.00 11.99 05.99 04.00	06.06 06.06 06.06 06.06 06.06 06.06 06.06 06.06 06.06 06.06 06.06 06.06	PR: 1LR,1LS,1ZF,1ZP,1ZM PR: 1LR,1LS,1ZF,1ZP,1ZM PR: 1LR,1LS,1ZF,1ZP,1ZM PR: 1LR,1LS,1ZF,1ZP,1ZM PR: 1LR,1LS,1ZF,1ZP,1ZM PR: 1LR,1LS,1ZF,1ZP,1ZM PR: 1LR,1LS,1ZF,1ZP,1ZM PR: 1LR,1LS,1ZF,1ZP,1ZM PR: 1LR,1LS,1ZF,1ZP,1ZM PR: 1LR,1LS,1ZF,1ZP,1ZM PR: 1LR,1LS,1ZF,1ZP,1ZM PR: 1LR,1LS,1ZF,1ZP,1ZM	BA2155		23131 19,6 +/WK VW
	2.3 V5 2.3 V5 4motion 2.8 V6 4motion		1J-X-800000 1J-X-800000 05.99	05.99 05.99 06.06	PR: 1ZE PR: 1ZE	BA2333		21911 20,3 + ATE
	1.8 T 1.9 TDI 1.9 TDI 4motion 2.3 V5 2.3 V5 4motion	110 96 96 1J-Y-000001 1J-Y-000001	05.00 04.01 04.01 06.06 06.06	06.06 06.06 06.06 06.06 06.06	PR: 1ZD,1ZE PR: 1ZD,1ZE PR: 1ZD,1ZE PR: 1ZD,1ZE PR: 1ZD,1ZE	BA2205		23392 20,6 +/WK ATE
	1.4 1.6 1.6 FSI 1.8 4motion 1.9 SDI 1.9 TDI 1.9 TDI 1.9 TDI 1.9 TDI 4motion 1.9 TDI 4motion 1.9 TDI 4motion 2.0 2.0 4motion	92 66 74 81 85 66 74 85 85 85	05.99 05.99 01.02 05.99 05.99 09.00 05.99 05.99 09.00 11.99 05.99 04.00	06.06 06.06 06.06 06.06 06.06 06.06 06.06 06.06 06.06 06.06 06.06 06.06	PR: 1LR,1LS,1ZF,1ZP,1ZM PR: 1LR,1LS,1ZF,1ZP,1ZM PR: 1LR,1LS,1ZF,1ZP,1ZM PR: 1LR,1LS,1ZF,1ZP,1ZM PR: 1LR,1LS,1ZF,1ZP,1ZM PR: 1LR,1LS,1ZF,1ZP,1ZM PR: 1LR,1LS,1ZF,1ZP,1ZM PR: 1LR,1LS,1ZF,1ZP,1ZM PR: 1LR,1LS,1ZF,1ZP,1ZM PR: 1LR,1LS,1ZF,1ZP,1ZM PR: 1LR,1LS,1ZF,1ZP,1ZM PR: 1LR,1LS,1ZF,1ZP,1ZM	BAR22150		280 22,0 19,0 V L
	1.8 T 1.9 TDI 1.9 TDI 4motion 2.3 V5 2.3 V5 4motion	110 96 96	05.00 04.01 04.01 05.99 05.99	06.06 06.06 06.06 06.06 06.06	PR: 1ZD,1ZE PR: 1ZD,1ZE PR: 1ZD,1ZE PR: 1ZD,1ZE PR: 1ZD,1ZE	BAR25113		288 25,0 22,0 V L
	2.8 V6 4motion		05.99	06.06		BAR25123		312 25,0 23,0 V L



	   kW													
<b>VOLKSWAGEN GOLF IV Variant (99-06)</b>														
	1.4		05.99	06.06	BAH0023	2		L=435						
	1.6		05.99	06.06										
	1.6 FSI		01.02	06.06										
	1.8 T	110	05.00	06.06										
	1.9 SDI		05.99	06.06										
	1.9 TDI	66	05.99	06.06										
	1.9 TDI	74	09.00	06.06										
	1.9 TDI	81	05.99	06.06										
	1.9 TDI	85	05.99	06.06										
	1.9 TDI	96	04.01	06.06										
	2.0	85	05.99	06.06										
2.3 V5		05.99	06.06											
	1.4		05.99	06.06	BA2017			20961 17,2 /S	LUC					
	1.6		05.99	06.06						PR: 1KE,1KP,1KT				
	1.6 FSI		01.02	06.06						PR: 1KE,1KP,1KT				
	1.8 4motion	92	05.99	06.06						PR: 1KE,1KP,1KT				
	1.8 T	110	05.00	06.06						PR: 1KE,1KP,1KT				
	1.9 SDI		05.99	06.06						PR: 1KE,1KP,1KT				
	1.9 TDI	66	05.99	06.06						PR: 1KE,1KP,1KT				
	1.9 TDI	74	09.00	06.06						PR: 1KE,1KP,1KT				
	1.9 TDI	81	05.99	06.06						PR: 1KE,1KP,1KT				
	1.9 TDI	85	05.99	06.06						PR: 1KE,1KP,1KT				
	1.9 TDI	96	04.01	06.06						PR: 1KE,1KP,1KT				
	1.9 TDI 4motion	66	05.99	06.06						PR: 1KE,1KP,1KT				
	1.9 TDI 4motion	74	09.00	06.06						PR: 1KE,1KP,1KT				
	1.9 TDI 4motion	85	11.99	06.06						PR: 1KE,1KP,1KT				
	1.9 TDI 4motion	96	04.01	06.06						PR: 1KE,1KP,1KT				
	2.0	85	05.99	06.06						PR: 1KE,1KP,1KT				
	2.0 4motion	85	04.00	06.06						PR: 1KE,1KP,1KT				
	2.3 V5		05.99	06.06						PR: 1KE,1KP,1KT				
	2.3 V5 4motion		05.99	06.06						PR: 1KE,1KP,1KT				
	1.8 4motion	92	05.99	06.06						PR: 2EE,2EL	BA2032		20961 15,2 /S	LUC
	1.9 TDI 4motion	66	05.99	06.06						PR: 2EE,2EL				
1.9 TDI 4motion	74	09.00	06.06	PR: 2EE,2EL										
1.9 TDI 4motion	85	11.99	06.06	PR: 2EE,2EL										
1.9 TDI 4motion	96	04.01	06.06	PR: 2EE,2EL										
2.0 4motion	85	04.00	06.06	PR: 2EE,2EL										
2.3 V5 4motion		05.99	06.06	PR: 2EE,2EL										
2.8 V6 4motion		05.99	06.06											
	1.4		05.99	06.06	BAR09123			232 8,9 7,0						
	1.6		05.99	06.06					PR: 1KP,1KT					
	1.6 FSI		01.02	06.06					PR: 1KP,1KT					
	1.8 T	110	05.00	06.06					PR: 1KP,1KT					
	1.9 SDI		05.99	06.06					PR: 1KP,1KT					
	1.9 TDI	66	05.99	06.06					PR: 1KP,1KT					
	1.9 TDI	74	09.00	06.06					PR: 1KP,1KT					
	1.9 TDI	81	05.99	06.06					PR: 1KP,1KT					
	1.9 TDI	85	05.99	06.06					PR: 1KP,1KT					
	1.9 TDI	96	04.01	06.06					PR: 1KP,1KT					
	2.0	85	05.99	06.06					PR: 1KP,1KT					
	2.3 V5		05.99	06.06					PR: 1KP,1KT					
	1.8 4motion	92	05.99	06.06					PR: 1KE	BAR09133		239 8,9 7,0		
	1.9 TDI 4motion	66	05.99	06.06					PR: 1KE					
	1.9 TDI 4motion	74	09.00	06.06					PR: 1KE					
1.9 TDI 4motion	85	11.99	06.06	PR: 1KE										
1.9 TDI 4motion	96	04.01	06.06	PR: 1KE										
2.0 4motion	85	04.00	06.06	PR: 1KE										
2.3 V5 4motion		05.99	06.06	PR: 1KE										
2.8 V6 4motion		05.99	06.06											
1.8 4motion	92	05.99	06.06	PR: 2EE,2EL	BAR22163		256 22,0 20,0 VL							
1.9 TDI 4motion	66	05.99	06.06	PR: 2EE,2EL										
1.9 TDI 4motion	74	09.00	06.06	PR: 2EE,2EL										
1.9 TDI 4motion	85	11.99	06.06	PR: 2EE,2EL										
1.9 TDI 4motion	96	04.01	06.06	PR: 2EE,2EL										
2.0 4motion	85	04.00	06.06	PR: 2EE,2EL										
2.3 V5 4motion		05.99	06.06	PR: 2EE,2EL										
	1.4		05.99	06.06	BAH0033	2		L=140						
	1.6		05.99	06.06										
	1.6 FSI		01.02	06.06										
	1.8 T	110	05.00	06.06										
	1.9 SDI		05.99	06.06										
	1.9 TDI	66	05.99	06.06										
	1.9 TDI	74	09.00	06.06										
	1.9 TDI	81	05.99	06.06										
	1.9 TDI	85	05.99	06.06										
	1.9 TDI	96	04.01	06.06										
	2.0	85	05.99	06.06										
	2.3 V5		05.99	06.06										
	1.8 4motion	92	05.99	06.06					BAH0033	2		L=140		
	1.9 TDI 4motion	66	05.99	06.06										
	1.9 TDI 4motion	74	09.00	06.06										
1.9 TDI 4motion	85	11.99	06.06											
1.9 TDI 4motion	96	04.01	06.06											
2.0 4motion	85	04.00	06.06											
2.3 V5 4motion		05.99	06.06											
2.8 V6 4motion		05.99	06.06											

**VOLKSWAGEN GOLF V (03-08)**













	1.4 16V	66	10.03	09.08	PR: 1ZF,1ZM,1ZC	BA2155		23131 19,6 +/WK	VW
	1.4 FSI	90	10.03	09.08	PR: 1ZF,1ZM,1ZC				
	1.4 TSI	103	05.07	09.08	PR: 1ZF,1ZM,1ZC				
	1.4 TSI	125	05.06	09.08	PR: 1ZF,1ZM,1ZC				
	1.6 16V	75	11.05	09.08	PR: 1ZF,1ZM,1ZC				
	1.6 FSI	85	01.04	09.08	PR: 1ZF,1ZM,1ZC				
	1.9 TDI	66	10.03	09.08	PR: 1ZF,1ZM,1ZC				
	1.9 TDI	77	05.04	09.08	PR: 1ZF,1ZM,1ZC				
	1.9 TDI 4motion	77	10.03	09.08	PR: 1ZF,1ZM,1ZC				
	2.0 FSI	110	08.04	09.08	PR: 1ZF,1ZM,1ZC				
	2.0 FSI 4motion	110	10.03	09.08	PR: 1ZF,1ZM,1ZC				
	2.0 GTI	147	08.04	09.08	PR: 1ZF,1ZM,1ZC				
	2.0 GTI	169	09.04	09.08	PR: 1ZF,1ZM,1ZC				
	2.0 SDI	55	09.06	09.08	PR: 1ZF,1ZM,1ZC				
	2.0 TDI	100	01.04	09.08	PR: 1ZF,1ZM,1ZC				
	2.0 TDI	103	10.03	09.08	PR: 1ZF,1ZM,1ZC				
	2.0 TDI	125	10.03	09.08	PR: 1ZF,1ZM,1ZC				
	2.0 TDI 4motion	103	11.05	09.08	PR: 1ZF,1ZM,1ZC				
	3.2 R32	184	08.04	09.08	PR: 1ZF,1ZM,1ZC				
			11.05	09.08	PR: 1ZF,1ZM,1ZC				
	1.4 16V	66	10.03	09.08	PR: 1LJ,1LL,1LV,1ZD,1ZP,1ZE	BA2195		23587 19,6 +/WK	ATE
	1.4 FSI	90	10.03	09.08	PR: 1LJ,1LL,1LV,1ZD,1ZP,1ZE				
	1.4 TSI	103	05.07	09.08	PR: 1LJ,1LL,1LV,1ZD,1ZP,1ZE				
	1.4 TSI	125	05.06	09.08	PR: 1LJ,1LL,1LV,1ZD,1ZP,1ZE				
	1.6 16V	75	11.05	09.08	PR: 1LJ,1LL,1LV,1ZD,1ZP,1ZE				
	1.6 FSI	85	01.04	09.08	PR: 1LJ,1LL,1LV,1ZD,1ZP,1ZE				
	1.9 TDI	66	10.03	09.08	PR: 1LJ,1LL,1LV,1ZD,1ZP,1ZE				
	1.9 TDI	77	05.04	09.08	PR: 1LJ,1LL,1LV,1ZD,1ZP,1ZE				
	1.9 TDI 4motion	77	10.03	09.08	PR: 1LJ,1LL,1LV,1ZD,1ZP,1ZE				
	2.0 FSI	110	08.04	09.08	PR: 1LJ,1LL,1LV,1ZD,1ZP,1ZE				
	2.0 FSI 4motion	110	10.03	09.08	PR: 1LJ,1LL,1LV,1ZD,1ZP,1ZE				
	2.0 GTI	147	08.04	09.08	PR: 1LJ,1LL,1LV,1ZD,1ZP,1ZE				
	2.0 GTI	169	09.04	09.08	PR: 1LJ,1LL,1LV,1ZD,1ZP,1ZE				
	2.0 SDI	55	09.06	09.08	PR: 1LJ,1LL,1LV,1ZD,1ZP,1ZE				
	2.0 TDI	100	01.04	09.08	PR: 1LJ,1LL,1LV,1ZD,1ZP,1ZE				
	2.0 TDI	103	10.03	09.08	PR: 1LJ,1LL,1LV,1ZD,1ZP,1ZE				
	2.0 TDI	125	10.03	09.08	PR: 1LJ,1LL,1LV,1ZD,1ZP,1ZE				
	2.0 TDI 4motion	103	11.05	09.08	PR: 1LJ,1LL,1LV,1ZD,1ZP,1ZE				
	3.2 R32	184	08.04	09.08	PR: 1LJ,1LL,1LV,1ZD,1ZP,1ZE				
			11.05	09.08	PR: 1LJ,1LL,1LV,1ZD,1ZP,1ZE				
	1.4 16V	66	10.03	09.08	PR: 1ZF,1ZM,1ZC	BAR22210		280 22,0 19,0 V L	
	1.4 FSI	90	10.03	09.08	PR: 1ZF,1ZM,1ZC				
	1.4 TSI	103	05.07	09.08	PR: 1ZF,1ZM,1ZC				
	1.4 TSI	125	05.06	09.08	PR: 1ZF,1ZM,1ZC				
	1.6 16V	75	11.05	09.08	PR: 1ZF,1ZM,1ZC				
	1.6 FSI	85	01.04	09.08	PR: 1ZF,1ZM,1ZC				
	1.9 TDI	66	10.03	09.08	PR: 1ZF,1ZM,1ZC				
	1.9 TDI	77	05.04	09.08	PR: 1ZF,1ZM,1ZC				
	1.9 TDI 4motion	77	10.03	09.08	PR: 1ZF,1ZM,1ZC				
	2.0 FSI	110	08.04	09.08	PR: 1ZF,1ZM,1ZC				
	2.0 FSI 4motion	110	10.03	09.08	PR: 1ZF,1ZM,1ZC				
	2.0 GTI	147	08.04	09.08	PR: 1ZF,1ZM,1ZC				
	2.0 GTI	169	09.04	09.08	PR: 1ZF,1ZM,1ZC				
	2.0 SDI	55	09.06	09.08	PR: 1ZF,1ZM,1ZC				
	2.0 TDI	100	01.04	09.08	PR: 1ZF,1ZM,1ZC				
	2.0 TDI	103	10.03	09.08	PR: 1ZF,1ZM,1ZC				
	2.0 TDI	125	10.03	09.08	PR: 1ZF,1ZM,1ZC				
	2.0 TDI 4motion	103	11.05	09.08	PR: 1ZF,1ZM,1ZC				
	3.2 R32	184	08.04	09.08	PR: 1ZF,1ZM,1ZC				
			11.05	09.08	PR: 1ZF,1ZM,1ZC				
	1.4 16V	66	10.03	09.08	PR: 1ZE,1ZP	BAR25145		288 24,9 22,0 V L	
	1.4 FSI	90	10.03	09.08	PR: 1ZE,1ZP				
	1.4 TSI	103	05.07	09.08	PR: 1ZE,1ZP				
	1.4 TSI	125	05.06	09.08	PR: 1ZE,1ZP				
	1.6 16V	75	11.05	09.08	PR: 1ZE,1ZP				
	1.6 FSI	85	01.04	09.08	PR: 1ZE,1ZP				
	1.9 TDI	66	10.03	09.08	PR: 1ZE,1ZP				
	1.9 TDI	77	05.04	09.08	PR: 1ZE,1ZP				
	1.9 TDI 4motion	77	10.03	09.08	PR: 1ZE,1ZP				
	2.0 FSI	110	08.04	09.08	PR: 1ZE,1ZP				
	2.0 FSI 4motion	110	10.03	09.08	PR: 1ZE,1ZP				
	2.0 GTI	147	08.04	09.08	PR: 1ZE,1ZP				
	2.0 GTI	169	09.04	09.08	PR: 1ZE,1ZP				
	2.0 SDI	55	09.06	09.08	PR: 1ZE,1ZP				
	2.0 TDI	100	01.04	09.08	PR: 1ZE,1ZP				
	2.0 TDI	103	10.03	09.08	PR: 1ZE,1ZP				
	2.0 TDI	125	10.03	09.08	PR: 1ZE,1ZP				
	2.0 TDI 4motion	103	11.05	09.08	PR: 1ZE,1ZP				
	3.2 R32	184	08.04	09.08	PR: 1ZE,1ZP				
			11.05	09.08	PR: 1ZE,1ZP				
	1.4 16V	66	10.03	09.08	PR: 1LJ,1LL,1LV,1ZD	BAR25158		312 25,0 22,0 V L	
	1.4 FSI	90	10.03	09.08	PR: 1LJ,1LL,1LV,1ZD				
	1.4 TSI	103	05.07	09.08	PR: 1LJ,1LL,1LV,1ZD				
	1.4 TSI	125	05.06	09.08	PR: 1LJ,1LL,1LV,1ZD				
	1.6 16V	75	11.05	09.08	PR: 1LJ,1LL,1LV,1ZD				
	1.6 FSI	85	01.04	09.08	PR: 1LJ,1LL,1LV,1ZD				
			10.03	09.08	PR: 1LJ,1LL,1LV,1ZD				



















VOLKSWAGEN GOLF V (03-08)														
	1.9 TDI 66 1.9 TDI 77 1.9 TDI 4motion 77 2.0 FSI 110 2.0 FSI 4motion 110 2.0 GTI 147 2.0 GTI 169 2.0 SDI 55 2.0 TDI 100 2.0 TDI 103 2.0 TDI 125 2.0 TDI 4motion 103 3.2 R32 184		05.04 09.08 PR: 1LJ,1LL,1LV,1ZD 10.03 09.08 PR: 1LJ,1LL,1LV,1ZD 08.04 09.08 PR: 1LJ,1LL,1LV,1ZD 10.03 09.08 PR: 1LJ,1LL,1LV,1ZD 08.04 09.08 PR: 1LJ,1LL,1LV,1ZD 09.04 09.08 PR: 1LJ,1LL,1LV,1ZD 09.06 09.08 PR: 1LJ,1LL,1LV,1ZD 01.04 09.08 PR: 1LJ,1LL,1LV,1ZD 10.03 09.08 PR: 1LJ,1LL,1LV,1ZD 10.03 09.08 PR: 1LJ,1LL,1LV,1ZD 11.05 09.08 PR: 1LJ,1LL,1LV,1ZD 08.04 09.08 PR: 1LJ,1LL,1LV,1ZD 11.05 09.08 PR: 1LJ,1LL,1LV,1ZD		BAR25158						312 25,0 22,0 V/L			
	1.4 16V 1.4 FSI 66 1.4 TSI 90 1.4 TSI 103 1.4 TSI 125 1.6 16V 75 1.6 FSI 85 1.9 TDI 66 1.9 TDI 77 2.0 FSI 110 2.0 GTI 147 2.0 GTI 169 2.0 SDI 55 2.0 TDI 100 2.0 TDI 103 2.0 TDI 125		10.03 09.08 PR: 1KD,1KQ 10.03 09.08 PR: 1KD,1KQ 05.07 09.08 PR: 1KD,1KQ 05.06 09.08 PR: 1KD,1KQ 11.05 09.08 PR: 1KD,1KQ 01.04 09.08 PR: 1KD,1KQ 10.03 09.08 PR: 1KD,1KQ 05.04 09.08 PR: 1KD,1KQ 10.03 09.08 PR: 1KD,1KQ 09.04 09.08 PR: 1KD,1KQ 09.06 09.08 PR: 1KD,1KQ 01.04 09.08 PR: 1KD,1KQ 10.03 09.08 PR: 1KD,1KQ 10.03 09.08 PR: 1KD,1KQ 11.05 09.08 PR: 1KD,1KQ		BA2017						20961 17,2 /S	LUC		
	1.4 16V 1.4 FSI 66 1.4 TSI 90 1.4 TSI 103 1.4 TSI 125 1.6 16V 75 1.6 FSI 85 1.9 TDI 66 1.9 TDI 77 1.9 TDI 4motion 77 2.0 FSI 110 2.0 FSI 4motion 110 2.0 GTI 147 2.0 GTI 169 2.0 SDI 55 2.0 TDI 100 2.0 TDI 103 2.0 TDI 4motion 103 3.2 R32 184		10.03 09.08 PR: 1KY,1KZ,1KF,2EL 10.03 09.08 PR: 1KY,1KZ,1KF,2EL 05.07 09.08 PR: 1KY,1KZ,1KF,2EL 05.06 09.08 PR: 1KY,1KZ,1KF,2EL 11.05 09.08 PR: 1KY,1KZ,1KF,2EL 01.04 09.08 PR: 1KY,1KZ,1KF,2EL 10.03 09.08 PR: 1KY,1KZ,1KF,2EL 05.04 09.08 PR: 1KY,1KZ,1KF,2EL 10.03 09.08 PR: 1KY,1KZ,1KF,2EL 08.04 09.08 PR: 1KY,1KZ,1KF,2EL 09.04 09.08 PR: 1KY,1KZ,1KF,2EL 09.06 09.08 PR: 1KY,1KZ,1KF,2EL 01.04 09.08 PR: 1KY,1KZ,1KF,2EL 10.03 09.08 PR: 1KY,1KZ,1KF,2EL 10.03 09.08 PR: 1KY,1KZ,1KF,2EL 08.04 09.08 PR: 1KY,1KZ,1KF,2EL 11.05 09.08 PR: 1KY,1KZ,1KF,2EL		BA2196						23914 16,3 /WE/S	LUC		
	1.4 16V 1.4 FSI 66 1.4 TSI 90 1.4 TSI 103 1.4 TSI 125 1.6 16V 75 1.6 FSI 85 1.9 TDI 66 1.9 TDI 77 2.0 FSI 110 2.0 GTI 147 2.0 GTI 169 2.0 SDI 55 2.0 TDI 100 2.0 TDI 103 2.0 TDI 125		10.03 09.08 PR: 1KE 10.03 09.08 PR: 1KE 05.07 09.08 PR: 1KE 05.06 09.08 PR: 1KE 11.05 09.08 PR: 1KE 01.04 09.08 PR: 1KE 10.03 09.08 PR: 1KE 05.04 09.08 PR: 1KE 10.03 09.08 PR: 1KE 09.04 09.08 PR: 1KE 09.06 09.08 PR: 1KE 01.04 09.08 PR: 1KE 10.03 09.08 PR: 1KE 10.03 09.08 PR: 1KE 11.05 09.08 PR: 1KE		BA2196						23914 16,3 /WE/S	LUC		
	1.4 16V 1.4 FSI 66 1.4 TSI 90 1.4 TSI 103 1.4 TSI 125 1.6 16V 75 1.6 FSI 85 1.9 TDI 66 1.9 TDI 77 1.9 TDI 4motion 77 2.0 FSI 110 2.0 FSI 4motion 110 2.0 GTI 147 2.0 GTI 169 2.0 SDI 55 2.0 TDI 100 2.0 TDI 103 2.0 TDI 125 2.0 TDI 4motion 103 3.2 R32 184		10.03 09.08 PR: 1KE,1KF 10.03 09.08 PR: 1KE,1KF 05.07 09.08 PR: 1KE,1KF 05.06 09.08 PR: 1KE,1KF 11.05 09.08 PR: 1KE,1KF 01.04 09.08 PR: 1KE,1KF 10.03 09.08 PR: 1KE,1KF 05.04 09.08 PR: 1KE,1KF 10.03 09.08 PR: 1KE,1KF 08.04 09.08 PR: 1KE,1KF 09.04 09.08 PR: 1KE,1KF 09.06 09.08 PR: 1KE,1KF 01.04 09.08 PR: 1KE,1KF 10.03 09.08 PR: 1KE,1KF 10.03 09.08 PR: 1KE,1KF 11.05 09.08 PR: 1KE,1KF 08.04 09.08 PR: 1KE,1KF 11.05 09.08 PR: 1KE,1KF		BAR12158						256 12,0 10,0			
	1.4 16V 1.4 FSI 66 1.4 TSI 90		10.03 09.08 PR: 1KY,1KZ,1KV 10.03 09.08 PR: 1KY,1KZ,1KV 05.07 09.08 PR: 1KY,1KZ,1KV		BAR12169						282 12,0 10,0			

















									
<b>VOLKSWAGEN GOLF V (03-08)</b>									
	1.4 TSI 103 1.4 TSI 125 1.6 16V 75 1.6 FSI 85 1.9 TDI 66 1.9 TDI 77 2.0 FSI 110 2.0 GTI 147 2.0 GTI 169 2.0 SDI 55 2.0 TDI 100 2.0 TDI 103 2.0 TDI 125		05.06 11.05 01.04 10.03 05.04 10.03 10.03 09.04 09.06 01.04 10.03 10.03	09.08 09.08 09.08 09.08 09.08 09.08 09.08 09.08 09.08 09.08 09.08 09.08	PR: 1KY,1KZ,1KV PR: 1KY,1KZ,1KV PR: 1KY,1KZ,1KV PR: 1KY,1KZ,1KV PR: 1KY,1KZ,1KV PR: 1KY,1KZ,1KV PR: 1KY,1KZ,1KV PR: 1KY,1KZ,1KV PR: 1KY,1KZ,1KV PR: 1KY,1KZ,1KV PR: 1KY,1KZ,1KV PR: 1KY,1KZ,1KV	BAR12169		282 12,0 10,0	
<b>VOLKSWAGEN GOLF V Variant (07-09)</b>									
	1.4 59 1.4 TSI 90 1.4 TSI 103 1.4 TSI 118 1.4 TSI 125 1.6 75 1.9 TDI 77 1.9 TDI 4motion 77 2.0 147 2.0 TDI 147		06.07 06.07 05.07 07.08 05.07 05.07 05.07 12.07 06.07 05.07	06.09 06.09 06.09 06.09 06.09 06.09 06.09 06.09 06.09 06.09	PR: 12M PR: 12M PR: 12M PR: 12M PR: 12M PR: 12M PR: 12M PR: 12M PR: 12M PR: 12M	BA2155		23131 19,6 +/-WK	VW
	1.4 59 1.4 TSI 90 1.4 TSI 103 1.4 TSI 118 1.4 TSI 125 1.6 75 1.9 TDI 77 1.9 TDI 4motion 77 2.0 147 2.0 TDI 147		06.07 06.07 05.07 07.08 05.07 05.07 05.07 12.07 06.07 05.07	06.09 06.09 06.09 06.09 06.09 06.09 06.09 06.09 06.09 06.09	PR: 1LJ,1ZD,1ZE,1ZP PR: 1LJ,1ZD,1ZE,1ZP PR: 1LJ,1ZD,1ZE,1ZP PR: 1LJ,1ZD,1ZE,1ZP PR: 1LJ,1ZD,1ZE,1ZP PR: 1LJ,1ZD,1ZE,1ZP PR: 1LJ,1ZD,1ZE,1ZP PR: 1LJ,1ZD,1ZE,1ZP PR: 1LJ,1ZD,1ZE,1ZP PR: 1LJ,1ZD,1ZE,1ZP	BA2195		23587 19,6 +/-WK	ATE
	1.4 59 1.4 TSI 90 1.4 TSI 103 1.4 TSI 118 1.4 TSI 125 1.6 75 1.9 TDI 77 1.9 TDI 4motion 77 2.0 147 2.0 TDI 147		06.07 06.07 05.07 07.08 05.07 05.07 05.07 12.07 06.07 05.07	06.09 06.09 06.09 06.09 06.09 06.09 06.09 06.09 06.09 06.09	PR: 12M PR: 12M PR: 12M PR: 12M PR: 12M PR: 12M PR: 12M PR: 12M PR: 12M PR: 12M	BAR22210		280 22,0 19,0 V L	
	1.4 59 1.4 TSI 90 1.4 TSI 103 1.4 TSI 118 1.4 TSI 125 1.6 75 1.9 TDI 77 1.9 TDI 4motion 77 2.0 147 2.0 TDI 147		06.07 06.07 05.07 07.08 05.07 05.07 05.07 12.07 06.07 05.07	06.09 06.09 06.09 06.09 06.09 06.09 06.09 06.09 06.09 06.09	PR: 1ZE,1ZP PR: 1ZE,1ZP PR: 1ZE,1ZP PR: 1ZE,1ZP PR: 1ZE,1ZP PR: 1ZE,1ZP PR: 1ZE,1ZP PR: 1ZE,1ZP PR: 1ZE,1ZP PR: 1ZE,1ZP	BAR25145		288 24,9 22,0 V L	
	1.4 59 1.4 TSI 90 1.4 TSI 103 1.4 TSI 118 1.4 TSI 125 1.6 75 1.9 TDI 77 1.9 TDI 4motion 77 2.0 147 2.0 TDI 147		06.07 06.07 05.07 07.08 05.07 05.07 05.07 12.07 06.07 05.07	06.09 06.09 06.09 06.09 06.09 06.09 06.09 06.09 06.09 06.09	PR: 1LJ,1ZD PR: 1LJ,1ZD PR: 1LJ,1ZD PR: 1LJ,1ZD PR: 1LJ,1ZD PR: 1LJ,1ZD PR: 1LJ,1ZD PR: 1LJ,1ZD PR: 1LJ,1ZD PR: 1LJ,1ZD	BAR25158		312 25,0 22,0 V L	
	1.4 59 1.4 TSI 90 1.4 TSI 103 1.4 TSI 118 1.4 TSI 125 1.6 75 1.9 TDI 77 1.9 TDI 4motion 77 2.0 147 2.0 TDI 147		06.07 06.07 05.07 07.08 05.07 05.07 05.07 12.07 06.07 05.07	06.09 06.09 06.09 06.09 06.09 06.09 06.09 06.09 06.09 06.09	PR: 1KE PR: 1KE PR: 1KE PR: 1KE PR: 1KE PR: 1KE PR: 1KE PR: 1KE PR: 1KE PR: 1KE	BA2196		23914 16,3 /WE/S	LUC
	1.4 59 1.4 TSI 90 1.4 TSI 103 1.4 TSI 118 1.4 TSI 125 1.6 75 1.9 TDI 77 1.9 TDI 4motion 77 2.0 147 2.0 TDI 147		06.07 06.07 05.07 07.08 05.07 05.07 05.07 12.07 06.07 05.07	06.09 06.09 06.09 06.09 06.09 06.09 06.09 06.09 06.09 06.09	PR: 1KF,1KJ PR: 1KF,1KJ PR: 1KF,1KJ PR: 1KF,1KJ PR: 1KF,1KJ PR: 1KF,1KJ PR: 1KF,1KJ PR: 1KF,1KJ PR: 1KF,1KJ PR: 1KF,1KJ	BA2196		23914 16,3 /WE/S	LUC













VOLKSWAGEN GOLF V Variant (07-09)																																																																																															
	<table border="1"> <tr><td>1.4</td><td>59</td><td>06.07</td><td>06.09</td><td>PR: 1KE,1KF</td><td rowspan="10">BAR12158</td><td rowspan="10"></td><td rowspan="10">256 12,0 10,0</td></tr> <tr><td>1.4 TSI</td><td>90</td><td>06.07</td><td>06.09</td><td>PR: 1KE,1KF</td></tr> <tr><td>1.4 TSI</td><td>103</td><td>05.07</td><td>06.09</td><td>PR: 1KE,1KF</td></tr> <tr><td>1.4 TSI</td><td>118</td><td>07.08</td><td>06.09</td><td>PR: 1KE,1KF</td></tr> <tr><td>1.4 TSI</td><td>125</td><td>05.07</td><td>06.09</td><td>PR: 1KE,1KF</td></tr> <tr><td>1.6</td><td>75</td><td>05.07</td><td>06.09</td><td>PR: 1KE,1KF</td></tr> <tr><td>1.9 TDI</td><td>77</td><td>05.07</td><td>06.09</td><td>PR: 1KE,1KF</td></tr> <tr><td>1.9 TDI 4motion</td><td>77</td><td>12.07</td><td>06.09</td><td>PR: 1KE,1KF</td></tr> <tr><td>2.0</td><td>147</td><td>06.07</td><td>06.09</td><td>PR: 1KE,1KF</td></tr> <tr><td>2.0 TDI</td><td></td><td>05.07</td><td>06.09</td><td>PR: 1KE,1KF</td></tr> </table>	1.4	59	06.07	06.09	PR: 1KE,1KF	BAR12158		256 12,0 10,0	1.4 TSI	90	06.07	06.09	PR: 1KE,1KF	1.4 TSI	103	05.07	06.09	PR: 1KE,1KF	1.4 TSI	118	07.08	06.09	PR: 1KE,1KF	1.4 TSI	125	05.07	06.09	PR: 1KE,1KF	1.6	75	05.07	06.09	PR: 1KE,1KF	1.9 TDI	77	05.07	06.09	PR: 1KE,1KF	1.9 TDI 4motion	77	12.07	06.09	PR: 1KE,1KF	2.0	147	06.07	06.09	PR: 1KE,1KF	2.0 TDI		05.07	06.09	PR: 1KE,1KF																																									
1.4	59	06.07	06.09	PR: 1KE,1KF	BAR12158					256 12,0 10,0																																																																																					
1.4 TSI	90	06.07	06.09	PR: 1KE,1KF																																																																																											
1.4 TSI	103	05.07	06.09	PR: 1KE,1KF																																																																																											
1.4 TSI	118	07.08	06.09	PR: 1KE,1KF																																																																																											
1.4 TSI	125	05.07	06.09	PR: 1KE,1KF																																																																																											
1.6	75	05.07	06.09	PR: 1KE,1KF																																																																																											
1.9 TDI	77	05.07	06.09	PR: 1KE,1KF																																																																																											
1.9 TDI 4motion	77	12.07	06.09	PR: 1KE,1KF																																																																																											
2.0	147	06.07	06.09	PR: 1KE,1KF																																																																																											
2.0 TDI		05.07	06.09	PR: 1KE,1KF																																																																																											
	<table border="1"> <tr><td>1.4</td><td>59</td><td>06.07</td><td>06.09</td><td>PR: 1KJ</td><td rowspan="10">BAR12169</td><td rowspan="10"></td><td rowspan="10">282 12,0 10,0</td></tr> <tr><td>1.4 TSI</td><td>90</td><td>06.07</td><td>06.09</td><td>PR: 1KJ</td></tr> <tr><td>1.4 TSI</td><td>103</td><td>05.07</td><td>06.09</td><td>PR: 1KJ</td></tr> <tr><td>1.4 TSI</td><td>118</td><td>07.08</td><td>06.09</td><td>PR: 1KJ</td></tr> <tr><td>1.4 TSI</td><td>125</td><td>05.07</td><td>06.09</td><td>PR: 1KJ</td></tr> <tr><td>1.6</td><td>75</td><td>05.07</td><td>06.09</td><td>PR: 1KJ</td></tr> <tr><td>1.9 TDI</td><td>77</td><td>05.07</td><td>06.09</td><td>PR: 1KJ</td></tr> <tr><td>1.9 TDI 4motion</td><td>77</td><td>12.07</td><td>06.09</td><td>PR: 1KJ</td></tr> <tr><td>2.0</td><td>147</td><td>06.07</td><td>06.09</td><td>PR: 1KJ</td></tr> <tr><td>2.0 TDI</td><td></td><td>05.07</td><td>06.09</td><td>PR: 1KJ</td></tr> </table>	1.4	59	06.07	06.09	PR: 1KJ	BAR12169		282 12,0 10,0	1.4 TSI	90	06.07	06.09	PR: 1KJ	1.4 TSI	103	05.07	06.09	PR: 1KJ	1.4 TSI	118	07.08	06.09	PR: 1KJ	1.4 TSI	125	05.07	06.09	PR: 1KJ	1.6	75	05.07	06.09	PR: 1KJ	1.9 TDI	77	05.07	06.09	PR: 1KJ	1.9 TDI 4motion	77	12.07	06.09	PR: 1KJ	2.0	147	06.07	06.09	PR: 1KJ	2.0 TDI		05.07	06.09	PR: 1KJ																																									
1.4	59	06.07	06.09	PR: 1KJ	BAR12169					282 12,0 10,0																																																																																					
1.4 TSI	90	06.07	06.09	PR: 1KJ																																																																																											
1.4 TSI	103	05.07	06.09	PR: 1KJ																																																																																											
1.4 TSI	118	07.08	06.09	PR: 1KJ																																																																																											
1.4 TSI	125	05.07	06.09	PR: 1KJ																																																																																											
1.6	75	05.07	06.09	PR: 1KJ																																																																																											
1.9 TDI	77	05.07	06.09	PR: 1KJ																																																																																											
1.9 TDI 4motion	77	12.07	06.09	PR: 1KJ																																																																																											
2.0	147	06.07	06.09	PR: 1KJ																																																																																											
2.0 TDI		05.07	06.09	PR: 1KJ																																																																																											
VOLKSWAGEN GOLF VI (08-)																																																																																															
	<table border="1"> <tr><td>1.2 TSI</td><td></td><td>05.09</td><td></td><td>PR: 1ZF</td><td rowspan="16">BA2155</td><td rowspan="16"></td><td rowspan="16">23131 19,6 +/WK</td><td rowspan="16">VW</td></tr> <tr><td>1.4</td><td>59</td><td>10.08</td><td></td><td>PR: 1ZF</td></tr> <tr><td>1.4 TSI</td><td>90</td><td>10.08</td><td></td><td>PR: 1ZF</td></tr> <tr><td>1.4 TSI</td><td>118</td><td>10.08</td><td></td><td>PR: 1ZF</td></tr> <tr><td>1.6</td><td>75</td><td>10.08</td><td></td><td>PR: 1ZF</td></tr> <tr><td>1.6 Bi-Fuel</td><td>75</td><td>03.09</td><td></td><td>PR: 1ZF</td></tr> <tr><td>1.6 TDI</td><td>66</td><td>02.09</td><td></td><td>PR: 1ZF</td></tr> <tr><td>1.6 TDI</td><td>77</td><td>02.09</td><td></td><td>PR: 1ZF</td></tr> <tr><td>1.8 TSI</td><td>118</td><td>06.09</td><td></td><td>PR: 1ZF</td></tr> <tr><td>2.0</td><td>147</td><td>03.09</td><td></td><td>PR: 1ZF</td></tr> <tr><td>2.0 R 4motion</td><td></td><td>11.09</td><td></td><td>PR: 1ZF</td></tr> <tr><td>2.0 TDI</td><td>81</td><td>10.08</td><td></td><td>PR: 1ZF</td></tr> <tr><td>2.0 TDI</td><td>100</td><td>10.08</td><td></td><td>PR: 1ZF</td></tr> <tr><td>2.0 TDI</td><td>103</td><td>10.08</td><td></td><td>PR: 1ZF</td></tr> <tr><td>2.0 TDI</td><td>125</td><td>04.09</td><td></td><td>PR: 1ZF</td></tr> <tr><td>2.0 TDI 4motion</td><td>103</td><td>10.08</td><td></td><td>PR: 1ZF</td></tr> <tr><td>2.0 TSI</td><td></td><td>07.09</td><td></td><td>PR: 1ZF</td></tr> <tr><td>2.5 FSI</td><td>125</td><td>08.09</td><td></td><td>PR: 1ZF</td></tr> </table>	1.2 TSI		05.09		PR: 1ZF	BA2155		23131 19,6 +/WK	VW	1.4	59	10.08		PR: 1ZF	1.4 TSI	90	10.08		PR: 1ZF	1.4 TSI	118	10.08		PR: 1ZF	1.6	75	10.08		PR: 1ZF	1.6 Bi-Fuel	75	03.09		PR: 1ZF	1.6 TDI	66	02.09		PR: 1ZF	1.6 TDI	77	02.09		PR: 1ZF	1.8 TSI	118	06.09		PR: 1ZF	2.0	147	03.09		PR: 1ZF	2.0 R 4motion		11.09		PR: 1ZF	2.0 TDI	81	10.08		PR: 1ZF	2.0 TDI	100	10.08		PR: 1ZF	2.0 TDI	103	10.08		PR: 1ZF	2.0 TDI	125	04.09		PR: 1ZF	2.0 TDI 4motion	103	10.08		PR: 1ZF	2.0 TSI		07.09		PR: 1ZF	2.5 FSI	125	08.09		PR: 1ZF
1.2 TSI		05.09		PR: 1ZF	BA2155						23131 19,6 +/WK	VW																																																																																			
1.4	59	10.08		PR: 1ZF																																																																																											
1.4 TSI	90	10.08		PR: 1ZF																																																																																											
1.4 TSI	118	10.08		PR: 1ZF																																																																																											
1.6	75	10.08		PR: 1ZF																																																																																											
1.6 Bi-Fuel	75	03.09		PR: 1ZF																																																																																											
1.6 TDI	66	02.09		PR: 1ZF																																																																																											
1.6 TDI	77	02.09		PR: 1ZF																																																																																											
1.8 TSI	118	06.09		PR: 1ZF																																																																																											
2.0	147	03.09		PR: 1ZF																																																																																											
2.0 R 4motion		11.09		PR: 1ZF																																																																																											
2.0 TDI	81	10.08		PR: 1ZF																																																																																											
2.0 TDI	100	10.08		PR: 1ZF																																																																																											
2.0 TDI	103	10.08		PR: 1ZF																																																																																											
2.0 TDI	125	04.09		PR: 1ZF																																																																																											
2.0 TDI 4motion	103	10.08		PR: 1ZF																																																																																											
2.0 TSI		07.09		PR: 1ZF																																																																																											
2.5 FSI	125	08.09		PR: 1ZF																																																																																											
	<table border="1"> <tr><td>1.2 TSI</td><td></td><td>05.09</td><td></td><td>PR: 1ZA,1ZB,1ZD,1ZE,1ZP,1LJ,1LL</td><td rowspan="16">BA2195</td><td rowspan="16"></td><td rowspan="16">23587 19,6 +/WK</td><td rowspan="16">ATE</td></tr> <tr><td>1.4</td><td>59</td><td>10.08</td><td></td><td>PR: 1ZA,1ZB,1ZD,1ZE,1ZP,1LJ,1LL</td></tr> <tr><td>1.4 TSI</td><td>90</td><td>10.08</td><td></td><td>PR: 1ZA,1ZB,1ZD,1ZE,1ZP,1LJ,1LL</td></tr> <tr><td>1.4 TSI</td><td>118</td><td>10.08</td><td></td><td>PR: 1ZA,1ZB,1ZD,1ZE,1ZP,1LJ,1LL</td></tr> <tr><td>1.6</td><td>75</td><td>10.08</td><td></td><td>PR: 1ZA,1ZB,1ZD,1ZE,1ZP,1LJ,1LL</td></tr> <tr><td>1.6 Bi-Fuel</td><td>75</td><td>03.09</td><td></td><td>PR: 1ZA,1ZB,1ZD,1ZE,1ZP,1LJ,1LL</td></tr> <tr><td>1.6 TDI</td><td>66</td><td>02.09</td><td></td><td>PR: 1ZA,1ZB,1ZD,1ZE,1ZP,1LJ,1LL</td></tr> <tr><td>1.6 TDI</td><td>77</td><td>02.09</td><td></td><td>PR: 1ZA,1ZB,1ZD,1ZE,1ZP,1LJ,1LL</td></tr> <tr><td>1.8 TSI</td><td>118</td><td>06.09</td><td></td><td>PR: 1ZA,1ZB,1ZD,1ZE,1ZP,1LJ,1LL</td></tr> <tr><td>2.0</td><td>147</td><td>03.09</td><td></td><td>PR: 1ZA,1ZB,1ZD,1ZE,1ZP,1LJ,1LL</td></tr> <tr><td>2.0 R 4motion</td><td></td><td>11.09</td><td></td><td>PR: 1ZA,1ZB,1ZD,1ZE,1ZP,1LJ,1LL</td></tr> <tr><td>2.0 TDI</td><td>81</td><td>10.08</td><td></td><td>PR: 1ZA,1ZB,1ZD,1ZE,1ZP,1LJ,1LL</td></tr> <tr><td>2.0 TDI</td><td>100</td><td>10.08</td><td></td><td>PR: 1ZA,1ZB,1ZD,1ZE,1ZP,1LJ,1LL</td></tr> <tr><td>2.0 TDI</td><td>103</td><td>10.08</td><td></td><td>PR: 1ZA,1ZB,1ZD,1ZE,1ZP,1LJ,1LL</td></tr> <tr><td>2.0 TDI</td><td>125</td><td>04.09</td><td></td><td>PR: 1ZA,1ZB,1ZD,1ZE,1ZP,1LJ,1LL</td></tr> <tr><td>2.0 TDI 4motion</td><td>103</td><td>10.08</td><td></td><td>PR: 1ZA,1ZB,1ZD,1ZE,1ZP,1LJ,1LL</td></tr> <tr><td>2.0 TSI</td><td></td><td>07.09</td><td></td><td>PR: 1ZA,1ZB,1ZD,1ZE,1ZP,1LJ,1LL</td></tr> <tr><td>2.5 FSI</td><td>125</td><td>08.09</td><td></td><td>PR: 1ZA,1ZB,1ZD,1ZE,1ZP,1LJ,1LL</td></tr> </table>	1.2 TSI		05.09		PR: 1ZA,1ZB,1ZD,1ZE,1ZP,1LJ,1LL	BA2195		23587 19,6 +/WK	ATE	1.4	59	10.08		PR: 1ZA,1ZB,1ZD,1ZE,1ZP,1LJ,1LL	1.4 TSI	90	10.08		PR: 1ZA,1ZB,1ZD,1ZE,1ZP,1LJ,1LL	1.4 TSI	118	10.08		PR: 1ZA,1ZB,1ZD,1ZE,1ZP,1LJ,1LL	1.6	75	10.08		PR: 1ZA,1ZB,1ZD,1ZE,1ZP,1LJ,1LL	1.6 Bi-Fuel	75	03.09		PR: 1ZA,1ZB,1ZD,1ZE,1ZP,1LJ,1LL	1.6 TDI	66	02.09		PR: 1ZA,1ZB,1ZD,1ZE,1ZP,1LJ,1LL	1.6 TDI	77	02.09		PR: 1ZA,1ZB,1ZD,1ZE,1ZP,1LJ,1LL	1.8 TSI	118	06.09		PR: 1ZA,1ZB,1ZD,1ZE,1ZP,1LJ,1LL	2.0	147	03.09		PR: 1ZA,1ZB,1ZD,1ZE,1ZP,1LJ,1LL	2.0 R 4motion		11.09		PR: 1ZA,1ZB,1ZD,1ZE,1ZP,1LJ,1LL	2.0 TDI	81	10.08		PR: 1ZA,1ZB,1ZD,1ZE,1ZP,1LJ,1LL	2.0 TDI	100	10.08		PR: 1ZA,1ZB,1ZD,1ZE,1ZP,1LJ,1LL	2.0 TDI	103	10.08		PR: 1ZA,1ZB,1ZD,1ZE,1ZP,1LJ,1LL	2.0 TDI	125	04.09		PR: 1ZA,1ZB,1ZD,1ZE,1ZP,1LJ,1LL	2.0 TDI 4motion	103	10.08		PR: 1ZA,1ZB,1ZD,1ZE,1ZP,1LJ,1LL	2.0 TSI		07.09		PR: 1ZA,1ZB,1ZD,1ZE,1ZP,1LJ,1LL	2.5 FSI	125	08.09		PR: 1ZA,1ZB,1ZD,1ZE,1ZP,1LJ,1LL
1.2 TSI		05.09		PR: 1ZA,1ZB,1ZD,1ZE,1ZP,1LJ,1LL	BA2195						23587 19,6 +/WK	ATE																																																																																			
1.4	59	10.08		PR: 1ZA,1ZB,1ZD,1ZE,1ZP,1LJ,1LL																																																																																											
1.4 TSI	90	10.08		PR: 1ZA,1ZB,1ZD,1ZE,1ZP,1LJ,1LL																																																																																											
1.4 TSI	118	10.08		PR: 1ZA,1ZB,1ZD,1ZE,1ZP,1LJ,1LL																																																																																											
1.6	75	10.08		PR: 1ZA,1ZB,1ZD,1ZE,1ZP,1LJ,1LL																																																																																											
1.6 Bi-Fuel	75	03.09		PR: 1ZA,1ZB,1ZD,1ZE,1ZP,1LJ,1LL																																																																																											
1.6 TDI	66	02.09		PR: 1ZA,1ZB,1ZD,1ZE,1ZP,1LJ,1LL																																																																																											
1.6 TDI	77	02.09		PR: 1ZA,1ZB,1ZD,1ZE,1ZP,1LJ,1LL																																																																																											
1.8 TSI	118	06.09		PR: 1ZA,1ZB,1ZD,1ZE,1ZP,1LJ,1LL																																																																																											
2.0	147	03.09		PR: 1ZA,1ZB,1ZD,1ZE,1ZP,1LJ,1LL																																																																																											
2.0 R 4motion		11.09		PR: 1ZA,1ZB,1ZD,1ZE,1ZP,1LJ,1LL																																																																																											
2.0 TDI	81	10.08		PR: 1ZA,1ZB,1ZD,1ZE,1ZP,1LJ,1LL																																																																																											
2.0 TDI	100	10.08		PR: 1ZA,1ZB,1ZD,1ZE,1ZP,1LJ,1LL																																																																																											
2.0 TDI	103	10.08		PR: 1ZA,1ZB,1ZD,1ZE,1ZP,1LJ,1LL																																																																																											
2.0 TDI	125	04.09		PR: 1ZA,1ZB,1ZD,1ZE,1ZP,1LJ,1LL																																																																																											
2.0 TDI 4motion	103	10.08		PR: 1ZA,1ZB,1ZD,1ZE,1ZP,1LJ,1LL																																																																																											
2.0 TSI		07.09		PR: 1ZA,1ZB,1ZD,1ZE,1ZP,1LJ,1LL																																																																																											
2.5 FSI	125	08.09		PR: 1ZA,1ZB,1ZD,1ZE,1ZP,1LJ,1LL																																																																																											
	<table border="1"> <tr><td>1.2 TSI</td><td></td><td>05.09</td><td></td><td>PR: 1ZF</td><td rowspan="16">BAR22210</td><td rowspan="16"></td><td rowspan="16">280 22,0 19,0 V L</td></tr> <tr><td>1.4</td><td>59</td><td>10.08</td><td></td><td>PR: 1ZF</td></tr> <tr><td>1.4 TSI</td><td>90</td><td>10.08</td><td></td><td>PR: 1ZF</td></tr> <tr><td>1.4 TSI</td><td>118</td><td>10.08</td><td></td><td>PR: 1ZF</td></tr> <tr><td>1.6</td><td>75</td><td>10.08</td><td></td><td>PR: 1ZF</td></tr> <tr><td>1.6 Bi-Fuel</td><td>75</td><td>03.09</td><td></td><td>PR: 1ZF</td></tr> <tr><td>1.6 TDI</td><td>66</td><td>02.09</td><td></td><td>PR: 1ZF</td></tr> <tr><td>1.6 TDI</td><td>77</td><td>02.09</td><td></td><td>PR: 1ZF</td></tr> <tr><td>1.8 TSI</td><td>118</td><td>06.09</td><td></td><td>PR: 1ZF</td></tr> <tr><td>2.0</td><td>147</td><td>03.09</td><td></td><td>PR: 1ZF</td></tr> <tr><td>2.0 R 4motion</td><td></td><td>11.09</td><td></td><td>PR: 1ZF</td></tr> <tr><td>2.0 TDI</td><td>81</td><td>10.08</td><td></td><td>PR: 1ZF</td></tr> <tr><td>2.0 TDI</td><td>100</td><td>10.08</td><td></td><td>PR: 1ZF</td></tr> <tr><td>2.0 TDI</td><td>103</td><td>10.08</td><td></td><td>PR: 1ZF</td></tr> <tr><td>2.0 TDI</td><td>125</td><td>04.09</td><td></td><td>PR: 1ZF</td></tr> <tr><td>2.0 TDI 4motion</td><td>103</td><td>10.08</td><td></td><td>PR: 1ZF</td></tr> <tr><td>2.0 TSI</td><td></td><td>07.09</td><td></td><td>PR: 1ZF</td></tr> <tr><td>2.5 FSI</td><td>125</td><td>08.09</td><td></td><td>PR: 1ZF</td></tr> </table>	1.2 TSI		05.09		PR: 1ZF	BAR22210		280 22,0 19,0 V L	1.4	59	10.08		PR: 1ZF	1.4 TSI	90	10.08		PR: 1ZF	1.4 TSI	118	10.08		PR: 1ZF	1.6	75	10.08		PR: 1ZF	1.6 Bi-Fuel	75	03.09		PR: 1ZF	1.6 TDI	66	02.09		PR: 1ZF	1.6 TDI	77	02.09		PR: 1ZF	1.8 TSI	118	06.09		PR: 1ZF	2.0	147	03.09		PR: 1ZF	2.0 R 4motion		11.09		PR: 1ZF	2.0 TDI	81	10.08		PR: 1ZF	2.0 TDI	100	10.08		PR: 1ZF	2.0 TDI	103	10.08		PR: 1ZF	2.0 TDI	125	04.09		PR: 1ZF	2.0 TDI 4motion	103	10.08		PR: 1ZF	2.0 TSI		07.09		PR: 1ZF	2.5 FSI	125	08.09		PR: 1ZF	
1.2 TSI		05.09		PR: 1ZF	BAR22210					280 22,0 19,0 V L																																																																																					
1.4	59	10.08		PR: 1ZF																																																																																											
1.4 TSI	90	10.08		PR: 1ZF																																																																																											
1.4 TSI	118	10.08		PR: 1ZF																																																																																											
1.6	75	10.08		PR: 1ZF																																																																																											
1.6 Bi-Fuel	75	03.09		PR: 1ZF																																																																																											
1.6 TDI	66	02.09		PR: 1ZF																																																																																											
1.6 TDI	77	02.09		PR: 1ZF																																																																																											
1.8 TSI	118	06.09		PR: 1ZF																																																																																											
2.0	147	03.09		PR: 1ZF																																																																																											
2.0 R 4motion		11.09		PR: 1ZF																																																																																											
2.0 TDI	81	10.08		PR: 1ZF																																																																																											
2.0 TDI	100	10.08		PR: 1ZF																																																																																											
2.0 TDI	103	10.08		PR: 1ZF																																																																																											
2.0 TDI	125	04.09		PR: 1ZF																																																																																											
2.0 TDI 4motion	103	10.08		PR: 1ZF																																																																																											
2.0 TSI		07.09		PR: 1ZF																																																																																											
2.5 FSI	125	08.09		PR: 1ZF																																																																																											
	<table border="1"> <tr><td>1.2 TSI</td><td></td><td>05.09</td><td></td><td>PR: 1ZE,1ZP</td><td rowspan="10">BAR25145</td><td rowspan="10"></td><td rowspan="10">288 24,9 22,0 V L</td></tr> <tr><td>1.4</td><td>59</td><td>10.08</td><td></td><td>PR: 1ZE,1ZP</td></tr> <tr><td>1.4 TSI</td><td>90</td><td>10.08</td><td></td><td>PR: 1ZE,1ZP</td></tr> <tr><td>1.4 TSI</td><td>118</td><td>10.08</td><td></td><td>PR: 1ZE,1ZP</td></tr> <tr><td>1.6</td><td>75</td><td>10.08</td><td></td><td>PR: 1ZE,1ZP</td></tr> <tr><td>1.6 Bi-Fuel</td><td>75</td><td>03.09</td><td></td><td>PR: 1ZE,1ZP</td></tr> <tr><td>1.6 TDI</td><td>66</td><td>02.09</td><td></td><td>PR: 1ZE,1ZP</td></tr> <tr><td>1.6 TDI</td><td>77</td><td>02.09</td><td></td><td>PR: 1ZE,1ZP</td></tr> <tr><td>1.8 TSI</td><td>118</td><td>06.09</td><td></td><td>PR: 1ZE,1ZP</td></tr> <tr><td>2.0</td><td>147</td><td>03.09</td><td></td><td>PR: 1ZE,1ZP</td></tr> <tr><td>2.0 R 4motion</td><td></td><td>11.09</td><td></td><td>PR: 1ZE,1ZP</td></tr> </table>	1.2 TSI		05.09		PR: 1ZE,1ZP	BAR25145		288 24,9 22,0 V L	1.4	59	10.08		PR: 1ZE,1ZP	1.4 TSI	90	10.08		PR: 1ZE,1ZP	1.4 TSI	118	10.08		PR: 1ZE,1ZP	1.6	75	10.08		PR: 1ZE,1ZP	1.6 Bi-Fuel	75	03.09		PR: 1ZE,1ZP	1.6 TDI	66	02.09		PR: 1ZE,1ZP	1.6 TDI	77	02.09		PR: 1ZE,1ZP	1.8 TSI	118	06.09		PR: 1ZE,1ZP	2.0	147	03.09		PR: 1ZE,1ZP	2.0 R 4motion		11.09		PR: 1ZE,1ZP																																				
1.2 TSI		05.09		PR: 1ZE,1ZP	BAR25145					288 24,9 22,0 V L																																																																																					
1.4	59	10.08		PR: 1ZE,1ZP																																																																																											
1.4 TSI	90	10.08		PR: 1ZE,1ZP																																																																																											
1.4 TSI	118	10.08		PR: 1ZE,1ZP																																																																																											
1.6	75	10.08		PR: 1ZE,1ZP																																																																																											
1.6 Bi-Fuel	75	03.09		PR: 1ZE,1ZP																																																																																											
1.6 TDI	66	02.09		PR: 1ZE,1ZP																																																																																											
1.6 TDI	77	02.09		PR: 1ZE,1ZP																																																																																											
1.8 TSI	118	06.09		PR: 1ZE,1ZP																																																																																											
2.0	147	03.09		PR: 1ZE,1ZP																																																																																											
2.0 R 4motion		11.09		PR: 1ZE,1ZP																																																																																											



	   kW									
<b>VOLKSWAGEN GOLF VI (08-)</b>										
	2.0 TDI	81	10.08	PR: 1ZE,1ZP	BAR25145			288 24,9 22,0 V L		
	2.0 TDI	100	10.08	PR: 1ZE,1ZP						
	2.0 TDI	103	10.08	PR: 1ZE,1ZP						
	2.0 TDI	125	04.09	PR: 1ZE,1ZP						
	2.0 TDI 4motion	103	10.08	PR: 1ZE,1ZP						
	2.0 TSI		07.09	PR: 1ZE,1ZP						
	2.5 FSI	125	08.09	PR: 1ZE,1ZP						
	1.2 TSI		05.09	PR: 1LJ,1LL,1LV,1ZA,1ZB,1ZD	BAR25158		312 25,0 22,0 V L			
	1.4	59	10.08	PR: 1LJ,1LL,1LV,1ZA,1ZB,1ZD						
	1.4 TSI	90	10.08	PR: 1LJ,1LL,1LV,1ZA,1ZB,1ZD						
	1.4 TSI	118	10.08	PR: 1LJ,1LL,1LV,1ZA,1ZB,1ZD						
	1.6	75	10.08	PR: 1LJ,1LL,1LV,1ZA,1ZB,1ZD						
	1.6 Bi-Fuel	75	03.09	PR: 1LJ,1LL,1LV,1ZA,1ZB,1ZD						
	1.6 TDI	66	02.09	PR: 1LJ,1LL,1LV,1ZA,1ZB,1ZD						
	1.6 TDI	77	02.09	PR: 1LJ,1LL,1LV,1ZA,1ZB,1ZD						
	1.8 TSI	118	06.09	PR: 1LJ,1LL,1LV,1ZA,1ZB,1ZD						
	2.0	147	03.09	PR: 1LJ,1LL,1LV,1ZA,1ZB,1ZD						
	2.0 R 4motion		11.09	PR: 1LJ,1LL,1LV,1ZA,1ZB,1ZD						
	2.0 TDI	81	10.08	PR: 1LJ,1LL,1LV,1ZA,1ZB,1ZD						
	2.0 TDI	100	10.08	PR: 1LJ,1LL,1LV,1ZA,1ZB,1ZD						
2.0 TDI	103	10.08	PR: 1LJ,1LL,1LV,1ZA,1ZB,1ZD							
2.0 TDI	125	04.09	PR: 1LJ,1LL,1LV,1ZA,1ZB,1ZD							
2.0 TDI 4motion	103	10.08	PR: 1LJ,1LL,1LV,1ZA,1ZB,1ZD							
2.0 TSI		07.09	PR: 1LJ,1LL,1LV,1ZA,1ZB,1ZD							
2.5 FSI	125	08.09	PR: 1LJ,1LL,1LV,1ZA,1ZB,1ZD							
	1.2 TSI		05.09	PR: 1KD		BA2017			20961 17,2 /S	LUC
	1.4	59	10.08	PR: 1KD						
	1.4 TSI	90	10.08	PR: 1KD						
	1.4 TSI	118	10.08	PR: 1KD						
	1.6	75	10.08	PR: 1KD						
	1.6 Bi-Fuel	75	03.09	PR: 1KD						
	1.6 TDI	66	02.09	PR: 1KD						
	1.6 TDI	77	02.09	PR: 1KD						
	1.8 TSI	118	06.09	PR: 1KD						
	2.0	147	03.09	PR: 1KD						
	2.0 TDI	81	10.08	PR: 1KD						
	2.0 TDI	100	10.08	PR: 1KD						
	2.0 TDI	103	10.08	PR: 1KD						
	2.0 TDI	125	04.09	PR: 1KD						
2.0 TSI		07.09	PR: 1KD							
2.5 FSI	125	08.09	PR: 1KD							
	1.2 TSI		05.09	PR: 1KF,1KY,1KZ	BA2196		23914 16,3 /WE/S	LUC		
	1.4	59	10.08	PR: 1KF,1KY,1KZ						
	1.4 TSI	90	10.08	PR: 1KF,1KY,1KZ						
	1.4 TSI	118	10.08	PR: 1KF,1KY,1KZ						
	1.6	75	10.08	PR: 1KF,1KY,1KZ						
	1.6 Bi-Fuel	75	03.09	PR: 1KF,1KY,1KZ						
	1.6 TDI	66	02.09	PR: 1KF,1KY,1KZ						
	1.6 TDI	77	02.09	PR: 1KF,1KY,1KZ						
	1.8 TSI	118	06.09	PR: 1KF,1KY,1KZ						
	2.0	147	03.09	PR: 1KF,1KY,1KZ						
	2.0 R 4motion		11.09	PR: 1KF,1KY,1KZ, 2EL						
	2.0 TDI	81	10.08	PR: 1KF,1KY,1KZ						
	2.0 TDI	100	10.08	PR: 1KF,1KY,1KZ						
	2.0 TDI	103	10.08	PR: 1KF,1KY,1KZ						
2.0 TDI	125	04.09	PR: 1KF,1KY,1KZ							
2.0 TDI 4motion	103	10.08	PR: 1KF,1KY,1KZ, 2EL							
2.0 TSI		07.09	PR: 1KF,1KY,1KZ							
2.5 FSI	125	08.09	PR: 1KF,1KY,1KZ							
	1.2 TSI		05.09	PR: 1KE,1KV	BA2196		23914 16,3 /WE/S	LUC		
	1.4	59	10.08	PR: 1KE,1KV						
	1.4 TSI	90	10.08	PR: 1KE,1KV						
	1.4 TSI	118	10.08	PR: 1KE,1KV						
	1.6	75	10.08	PR: 1KE,1KV						
	1.6 Bi-Fuel	75	03.09	PR: 1KE,1KV						
	1.6 TDI	66	02.09	PR: 1KE,1KV						
	1.6 TDI	77	02.09	PR: 1KE,1KV						
	1.8 TSI	118	06.09	PR: 1KE,1KV						
	2.0	147	03.09	PR: 1KE,1KV						
	2.0 R 4motion		11.09	PR: 1KE,1KV,1KW						
	2.0 TDI	81	10.08	PR: 1KE,1KV						
	2.0 TDI	100	10.08	PR: 1KE,1KV						
	2.0 TDI	103	10.08	PR: 1KE,1KV						
2.0 TDI	125	04.09	PR: 1KE,1KV							
2.0 TDI 4motion	103	10.08	PR: 1KE,1KV,1KW							
2.0 TSI		07.09	PR: 1KE,1KV							
2.5 FSI	125	08.09	PR: 1KE,1KV							
	1.2 TSI		05.09	PR: 1KV,1KY,1KZ	BAR12169		282 12,0 10,0			
	1.4	59	10.08	PR: 1KV,1KY,1KZ						
	1.4 TSI	90	10.08	PR: 1KV,1KY,1KZ						
	1.4 TSI	118	10.08	PR: 1KV,1KY,1KZ						
	1.6	75	10.08	PR: 1KV,1KY,1KZ						
	1.6 Bi-Fuel	75	03.09	PR: 1KV,1KY,1KZ						
	1.6 TDI	66	02.09	PR: 1KV,1KY,1KZ						
	1.6 TDI	77	02.09	PR: 1KV,1KY,1KZ						
	1.8 TSI	118	06.09	PR: 1KV,1KY,1KZ						
2.0	147	03.09	PR: 1KV,1KY,1KZ							

	   kW											
<b>VOLKSWAGEN GOLF VI (08-)</b>												
	2.0 TDI	81		<b>10.08</b>	PR: 1KV,1KY,1KZ	<b>BAR12169</b>		282 12,0 10,0				
	2.0 TDI	100		<b>10.08</b>	PR: 1KV,1KY,1KZ							
	2.0 TDI	103		<b>10.08</b>	PR: 1KV,1KY,1KZ							
	2.0 TDI	125		<b>04.09</b>	PR: 1KV,1KY,1KZ							
	2.0 TSI			<b>07.09</b>	PR: 1KV,1KY,1KZ							
	2.5 FSI	125		<b>08.09</b>	PR: 1KV,1KY,1KZ							
		1.2 TSI			<b>05.09</b>	PR: 1KE,1KF	<b>BAR12158</b>	256 12,0 10,0				
		1.4	59		<b>10.08</b>	PR: 1KE,1KF						
		1.4 TSI	90		<b>10.08</b>	PR: 1KE,1KF						
		1.4 TSI	118		<b>10.08</b>	PR: 1KE,1KF						
		1.6	75		<b>10.08</b>	PR: 1KE,1KF						
		1.6 Bi-Fuel	75		<b>03.09</b>	PR: 1KE,1KF						
		1.6 TDI	66		<b>02.09</b>	PR: 1KE,1KF						
		1.6 TDI	77		<b>02.09</b>	PR: 1KE,1KF						
		1.8 TSI	118		<b>06.09</b>	PR: 1KE,1KF						
		2.0	147		<b>03.09</b>	PR: 1KE,1KF						
		2.0 R 4motion			<b>11.09</b>	PR: 1KE,1KF						
		2.0 TDI	81		<b>10.08</b>	PR: 1KE,1KF						
		2.0 TDI	100		<b>10.08</b>	PR: 1KE,1KF						
		2.0 TDI	103		<b>10.08</b>	PR: 1KE,1KF						
2.0 TDI	125		<b>04.09</b>	PR: 1KE,1KF								
2.0 TDI 4motion	103		<b>10.08</b>	PR: 1KE,1KF								
2.0 TSI			<b>07.09</b>	PR: 1KE,1KF								
2.5 FSI	125		<b>08.09</b>	PR: 1KE,1KF								
<b>VOLKSWAGEN GOLF VI Variant (09-)</b>												
	1.2 TSI			<b>08.09</b>	PR: 1ZM	<b>BA2155</b>	23131 19,6 +/WK	<b>VW</b>				
	1.4	59		<b>07.09</b>	PR: 1ZM							
	1.4 TSI	90		<b>07.09</b>	PR: 1ZM							
	1.4 TSI	118		<b>07.09</b>	PR: 1ZM							
	1.6	75		<b>07.09</b>	PR: 1ZM							
	1.6 TDI			<b>07.09</b>	PR: 1ZM							
	1.6 TDI 4motion	77		<b>07.09</b>	PR: 1ZM							
	2.0 TDI			<b>07.09</b>	PR: 1ZM							
	1.2 TSI			<b>08.09</b>	PR: 1ZA,1ZD,1ZE,1ZP,1LJ				<b>BA2195</b>	23587 19,6 +/WK	<b>ATE</b>	
	1.4	59		<b>07.09</b>	PR: 1ZA,1ZD,1ZE,1ZP,1LJ							
1.4 TSI	90		<b>07.09</b>	PR: 1ZA,1ZD,1ZE,1ZP,1LJ								
1.4 TSI	118		<b>07.09</b>	PR: 1ZA,1ZD,1ZE,1ZP,1LJ								
1.6	75		<b>07.09</b>	PR: 1ZA,1ZD,1ZE,1ZP,1LJ								
1.6 TDI			<b>07.09</b>	PR: 1ZA,1ZD,1ZE,1ZP,1LJ								
1.6 TDI 4motion	77		<b>07.09</b>	PR: 1ZA,1ZD,1ZE,1ZP,1LJ								
2.0 TDI			<b>07.09</b>	PR: 1ZA,1ZD,1ZE,1ZP,1LJ								
	1.2 TSI			<b>08.09</b>	PR: 1ZM	<b>BAR22210</b>	280 22,0 19,0 V L					
	1.4	59		<b>07.09</b>	PR: 1ZM							
	1.4 TSI	90		<b>07.09</b>	PR: 1ZM							
	1.4 TSI	118		<b>07.09</b>	PR: 1ZM							
	1.6	75		<b>07.09</b>	PR: 1ZM							
	1.6 TDI			<b>07.09</b>	PR: 1ZM							
	1.6 TDI 4motion	77		<b>07.09</b>	PR: 1ZM							
	2.0 TDI			<b>07.09</b>	PR: 1ZM							
		1.2 TSI			<b>08.09</b>				PR: 1LJ,1ZA,1ZD	<b>BAR25158</b>	312 25,0 22,0 V L	
		1.4	59		<b>07.09</b>				PR: 1LJ,1ZA,1ZD			
1.4 TSI		90		<b>07.09</b>	PR: 1LJ,1ZA,1ZD							
1.4 TSI		118		<b>07.09</b>	PR: 1LJ,1ZA,1ZD							
1.6		75		<b>07.09</b>	PR: 1LJ,1ZA,1ZD							
1.6 TDI				<b>07.09</b>	PR: 1LJ,1ZA,1ZD							
1.6 TDI 4motion		77		<b>07.09</b>	PR: 1LJ,1ZA,1ZD							
2.0 TDI				<b>07.09</b>	PR: 1LJ,1ZA,1ZD							
		1.2 TSI			<b>08.09</b>	PR: 1ZE,1ZP	<b>BAR25145</b>	288 24,9 22,0 V L				
		1.4	59		<b>07.09</b>	PR: 1ZE,1ZP						
	1.4 TSI	90		<b>07.09</b>	PR: 1ZE,1ZP							
	1.4 TSI	118		<b>07.09</b>	PR: 1ZE,1ZP							
	1.6	75		<b>07.09</b>	PR: 1ZE,1ZP							
	1.6 TDI			<b>07.09</b>	PR: 1ZE,1ZP							
	1.6 TDI 4motion	77		<b>07.09</b>	PR: 1ZE,1ZP							
	2.0 TDI			<b>07.09</b>	PR: 1ZE,1ZP							
		1.2 TSI			<b>08.09</b>	PR: 1KF,1KJ				<b>BA2196</b>	23914 16,3 /WE/S	<b>LUC</b>
		1.4	59		<b>07.09</b>	PR: 1KF,1KJ						
1.4 TSI		90		<b>07.09</b>	PR: 1KF,1KJ							
1.4 TSI		118		<b>07.09</b>	PR: 1KF,1KJ							
1.6		75		<b>07.09</b>	PR: 1KF,1KJ							
1.6 TDI				<b>07.09</b>	PR: 1KF,1KJ							
1.6 TDI 4motion		77		<b>07.09</b>	PR: 1KF,1KJ							
2.0 TDI				<b>07.09</b>	PR: 1KF,1KJ							
		1.2 TSI			<b>08.09</b>	PR: 1KE	<b>BA2196</b>	23914 16,3 /WE/S	<b>LUC</b>			
		1.4	59		<b>07.09</b>	PR: 1KE						
	1.4 TSI	90		<b>07.09</b>	PR: 1KE							
	1.4 TSI	118		<b>07.09</b>	PR: 1KE							
	1.6	75		<b>07.09</b>	PR: 1KE							
	1.6 TDI			<b>07.09</b>	PR: 1KE							
	1.6 TDI 4motion	77		<b>07.09</b>	PR: 1KE							
	2.0 TDI			<b>07.09</b>	PR: 1KE							
		1.2 TSI			<b>08.09</b>	PR: 1KE,1KF				<b>BAR12158</b>	256 12,0 10,0	
		1.4	59		<b>07.09</b>	PR: 1KE,1KF						
1.4 TSI		90		<b>07.09</b>	PR: 1KE,1KF							
1.4 TSI		118		<b>07.09</b>	PR: 1KE,1KF							



	   kW									
<b>VOLKSWAGEN GOLF VI Variant (09-)</b>										
	1.6	75	07.09	PR: 1KE,1KF	BAR12158			256 12,0 10,0		
	1.6 TDI		07.09	PR: 1KE,1KF						
	1.6 TDI 4motion	77	07.09	PR: 1KE,1KF						
	2.0 TDI		07.09	PR: 1KE,1KF						
	1.2 TSI		08.09	PR: 1KJ	BAR12169			282 12,0 10,0		
	1.4	59	07.09	PR: 1KJ						
	1.4 TSI	90	07.09	PR: 1KJ						
	1.4 TSI	118	07.09	PR: 1KJ						
1.6	75	07.09	PR: 1KJ							
1.6 TDI		07.09	PR: 1KJ							
1.6 TDI 4motion	77	07.09	PR: 1KJ							
2.0 TDI		07.09	PR: 1KJ							
<b>VOLKSWAGEN GOLF VI Cabriolet (11-)</b>										
	1.2 TSI	77	06.11	PR: 1ZE,1ZD,1ZP,1ZA,1ZB	BA2195			23587 19,6 +/-WK ATE		
	1.4 TSI	90	06.11	PR: 1ZE,1ZD,1ZP,1ZA,1ZB						
	1.4 TSI	118	06.11	PR: 1ZE,1ZD,1ZP,1ZA,1ZB						
	1.6 TDI	77	06.11	PR: 1ZE,1ZD,1ZP,1ZA,1ZB						
	2.0 GTI	155	04.12	PR: 1ZE,1ZD,1ZP,1ZA,1ZB						
	2.0 TDI	103	06.11	PR: 1ZE,1ZD,1ZP,1ZA,1ZB						
	2.0 TSI	155	06.11	PR: 1ZE,1ZD,1ZP,1ZA,1ZB						
	1.2 TSI	77	06.11	PR: 1ZE,1ZP	BAR25145			288 24,9 22,0 V L		
	1.4 TSI	90	06.11	PR: 1ZE,1ZP						
	1.4 TSI	118	06.11	PR: 1ZE,1ZP						
	1.6 TDI	77	06.11	PR: 1ZE,1ZP						
	2.0 TDI	103	06.11	PR: 1ZE,1ZP	BAR25158			312 25,0 22,0 V L		
	2.0 TSI	155	06.11	PR: 1ZE,1ZP						
	1.2 TSI	77	06.11	PR: 1ZA,1ZD,1ZB						
	1.4 TSI	90	06.11	PR: 1ZA,1ZD,1ZB						
1.4 TSI	118	06.11	PR: 1ZA,1ZD,1ZB							
1.6 TDI	77	06.11	PR: 1ZA,1ZD,1ZB							
2.0 TDI	103	06.11	PR: 1ZA,1ZD,1ZB							
2.0 TSI	155	06.11	PR: 1ZA,1ZD,1ZB							
	1.2 TSI	77	06.11	PR: 1KD	BA2017			20961 17,2 /S LUC		
	1.4 TSI	90	06.11	PR: 1KD						
	1.4 TSI	118	06.11	PR: 1KD						
	1.6 TDI	77	06.11	PR: 1KD						
	2.0 GTI	155	04.12	PR: 1KD						
	2.0 TDI	103	06.11	PR: 1KD						
	2.0 TSI	155	06.11	PR: 1KD						
<b>VOLKSWAGEN GOLF Plus (05-)</b>										
	1.2 TSI		08.09	PR: 1ZF,1ZM	BA2155			23131 19,6 +/-WK VW		
	1.4 16V		01.05	PR: 1ZF,1ZM						
	1.4 FSI	66	07.05	PR: 1ZF,1ZM						
	1.4 TSI	90	06.07	PR: 1ZF,1ZM						
	1.4 TSI	103	05.06	PR: 1ZF,1ZM						
	1.4 TSI	118	06.08	PR: 1ZF,1ZM						
	1.4 TSI	125	05.06	PR: 1ZF,1ZM						
	1.6	75	05.05	PR: 1ZF,1ZM						
	1.6 BiFuel	75	05.09	PR: 1ZF,1ZM						
	1.6 FSI	85	01.05	PR: 1ZF,1ZM						
	1.6 TDI		02.09	PR: 1ZF,1ZM						
	1.9 TDI	66	05.05	PR: 1ZF,1ZM						
	1.9 TDI	77	01.05	PR: 1ZF,1ZM						
	2.0 FSI	110	05.05	PR: 1ZF,1ZM						
	2.0 TDI		05.05	PR: 1ZF,1ZM						
	2.0 TDI	81	01.09	PR: 1ZF,1ZM						
	2.0 TDI	103	01.05	PR: 1ZF,1ZM						
		1.2 TSI		08.09		PR: 1ZA,1ZP,1ZE,1LJ	BA2195			23587 19,6 +/-WK ATE
		1.4 16V		01.05		PR: 1ZA,1ZP,1ZE,1LJ				
		1.4 FSI	66	07.05		PR: 1ZA,1ZP,1ZE,1LJ				
1.4 TSI		90	06.07	PR: 1ZA,1ZP,1ZE,1LJ						
1.4 TSI		103	05.06	PR: 1ZA,1ZP,1ZE,1LJ						
1.4 TSI		118	06.08	PR: 1ZA,1ZP,1ZE,1LJ						
1.4 TSI		125	05.06	PR: 1ZA,1ZP,1ZE,1LJ						
1.6		75	05.05	PR: 1ZA,1ZP,1ZE,1LJ						
1.6 BiFuel		75	05.09	PR: 1ZA,1ZP,1ZE,1LJ						
1.6 FSI		85	01.05	PR: 1ZA,1ZP,1ZE,1LJ						
1.6 TDI			02.09	PR: 1ZA,1ZP,1ZE,1LJ						
1.9 TDI		66	05.05	PR: 1ZA,1ZP,1ZE,1LJ						
1.9 TDI		77	01.05	PR: 1ZA,1ZP,1ZE,1LJ						
2.0 FSI		110	05.05	PR: 1ZA,1ZP,1ZE,1LJ						
2.0 TDI			05.05	PR: 1ZA,1ZP,1ZE,1LJ						
2.0 TDI		81	01.09	PR: 1ZA,1ZP,1ZE,1LJ						
2.0 TDI		103	01.05	PR: 1ZA,1ZP,1ZE,1LJ						
		1.2 TSI		08.09	PR: 1ZF,1ZM	BAR22210				280 22,0 19,0 V L
		1.4 16V		01.05	PR: 1ZF,1ZM					
		1.4 FSI	66	07.05	PR: 1ZF,1ZM					
	1.4 TSI	90	06.07	PR: 1ZF,1ZM						
	1.4 TSI	103	05.06	PR: 1ZF,1ZM						
	1.4 TSI	118	06.08	PR: 1ZF,1ZM						
	1.4 TSI	125	05.06	PR: 1ZF,1ZM						
	1.6	75	05.05	PR: 1ZF,1ZM						
	1.6 BiFuel	75	05.09	PR: 1ZF,1ZM						
	1.6 FSI	85	01.05	PR: 1ZF,1ZM						
	1.6 TDI		02.09	PR: 1ZF,1ZM						















	   kW									
<b>VOLKSWAGEN GOLF Plus (05-)</b>										
	1.9 TDI	66	05.05	PR: 1ZF,1ZM	BAR22210			280 22,0 19,0 V L		
	1.9 TDI	77	01.05	PR: 1ZF,1ZM						
	2.0 FSI	110	05.05	PR: 1ZF,1ZM						
	2.0 TDI	81	01.09	PR: 1ZF,1ZM						
	2.0 TDI	103	01.05	PR: 1ZF,1ZM						
	1.2 TSI		08.09	PR: 1ZE,1ZP		BAR25145			288 24,9 22,0 V L	
	1.4 16V		01.05	PR: 1ZE,1ZP						
	1.4 FSI	66	07.05	PR: 1ZE,1ZP						
	1.4 TSI	90	06.07	PR: 1ZE,1ZP						
	1.4 TSI	103	05.06	PR: 1ZE,1ZP						
	1.4 TSI	118	06.08	PR: 1ZE,1ZP						
	1.4 TSI	125	05.06	PR: 1ZE,1ZP						
	1.6	75	05.05	PR: 1ZE,1ZP						
	1.6 BiFuel	75	05.09	PR: 1ZE,1ZP						
	1.6 FSI	85	01.05	PR: 1ZE,1ZP						
	1.6 TDI		02.09	PR: 1ZE,1ZP						
	1.9 TDI	66	05.05	PR: 1ZE,1ZP						
	1.9 TDI	77	01.05	PR: 1ZE,1ZP						
	2.0 FSI	110	05.05	PR: 1ZE,1ZP						
	2.0 TDI	81	01.09	PR: 1ZE,1ZP						
	2.0 TDI	103	01.05	PR: 1ZE,1ZP						
	1.2 TSI		08.09	PR: 1LJ,1ZA	BAR25158			312 25,0 22,0 V L		
	1.4 16V		01.05	PR: 1LJ,1ZA						
	1.4 FSI	66	07.05	PR: 1LJ,1ZA						
	1.4 TSI	90	06.07	PR: 1LJ,1ZA						
	1.4 TSI	103	05.06	PR: 1LJ,1ZA						
	1.4 TSI	118	06.08	PR: 1LJ,1ZA						
	1.4 TSI	125	05.06	PR: 1LJ,1ZA						
	1.6	75	05.05	PR: 1LJ,1ZA						
	1.6 BiFuel	75	05.09	PR: 1LJ,1ZA						
1.6 FSI	85	01.05	PR: 1LJ,1ZA							
1.6 TDI		02.09	PR: 1LJ,1ZA							
1.9 TDI	66	05.05	PR: 1LJ,1ZA							
1.9 TDI	77	01.05	PR: 1LJ,1ZA							
2.0 FSI	110	05.05	PR: 1LJ,1ZA							
2.0 TDI	81	01.09	PR: 1LJ,1ZA							
2.0 TDI	103	01.05	PR: 1LJ,1ZA							
	1.4 16V		01.05	PR: 1KD		BA2017			20961 17,2 /S	LUC
	1.4 FSI	66	07.05	PR: 1KD						
	1.4 TSI	90	06.07	PR: 1KD						
	1.4 TSI	103	05.06	PR: 1KD						
	1.4 TSI	118	06.08	PR: 1KD						
	1.4 TSI	125	05.06	PR: 1KD						
	1.6	75	05.05	PR: 1KD						
	1.6 BiFuel	75	05.09	PR: 1KD						
	1.6 BiFuel	75	05.09	PR: 1KD						
	1.6 FSI	85	01.05	PR: 1KD						
	1.6 TDI		02.09	PR: 1KD						
	1.6 TDI		02.09	PR: 1KD						
	1.9 TDI	66	05.05	PR: 1KD						
	1.9 TDI	77	01.05	PR: 1KD						
	2.0 FSI	110	05.05	PR: 1KD						
	2.0 TDI	81	01.09	PR: 1KD						
	2.0 TDI	103	01.05	PR: 1KD						
	1.2 TSI		08.09	PR: 1KE,1KZ	BA2196			23914 16,3 /WE/S		
	1.4 16V		01.05	PR: 1KE,1KZ						
	1.4 FSI	66	07.05	PR: 1KE,1KZ						
	1.4 TSI	90	06.07	PR: 1KE,1KZ						
	1.4 TSI	103	05.06	PR: 1KE,1KZ						
	1.4 TSI	118	06.08	PR: 1KE,1KZ						
	1.4 TSI	125	05.06	PR: 1KE,1KZ						
	1.6	75	05.05	PR: 1KE,1KZ						
	1.6 BiFuel	75	05.09	PR: 1KE,1KZ						
	1.6 FSI	85	01.05	PR: 1KE,1KZ						
	1.6 TDI		02.09	PR: 1KE,1KZ						
	1.9 TDI	66	05.05	PR: 1KE,1KZ						
	1.9 TDI	77	01.05	PR: 1KE,1KZ						
2.0 FSI	110	05.05	PR: 1KE,1KZ							
2.0 TDI	81	01.09	PR: 1KE,1KZ							
2.0 TDI	103	01.05	PR: 1KE,1KZ							
	1.2 TSI		08.09	PR: 1KE		BAR12158			256 12,0 10,0	
	1.4 16V		01.05	PR: 1KE						
	1.4 FSI	66	07.05	PR: 1KE						
	1.4 TSI	90	06.07	PR: 1KE						
	1.4 TSI	103	05.06	PR: 1KE						
	1.4 TSI	118	06.08	PR: 1KE						
	1.4 TSI	125	05.06	PR: 1KE						
	1.6	75	05.05	PR: 1KE						
	1.6 BiFuel	75	05.09	PR: 1KE						
	1.6 FSI	85	01.05	PR: 1KE						
	1.6 TDI		02.09	PR: 1KE						
	1.9 TDI	66	05.05	PR: 1KE						





















**VOLKSWAGEN GOLF Plus (05-)**

	1.9 TDI	77		<b>01.05</b>	PR: 1KE	<b>BAR12158</b>		256 12,0 10,0
	2.0 FSI	110		<b>05.05</b>	PR: 1KE			
	2.0 TDI			<b>05.05</b>	PR: 1KE			
	2.0 TDI	81		<b>01.09</b>	PR: 1KE			
	2.0 TDI	103		<b>01.05</b>	PR: 1KE			
	1.2 TSI			<b>08.09</b>	PR: 1KZ	<b>BAR12169</b>		282 12,0 10,0
	1.4 16V			<b>01.05</b>	PR: 1KZ			
	1.4 FSI	66		<b>07.05</b>	PR: 1KZ			
	1.4 TSI	90		<b>06.07</b>	PR: 1KZ			
	1.4 TSI	103		<b>05.06</b>	PR: 1KZ			
	1.4 TSI	118		<b>06.08</b>	PR: 1KZ			
	1.4 TSI	125		<b>05.06</b>	PR: 1KZ			
	1.6	75		<b>05.05</b>	PR: 1KZ			
	1.6 BiFuel	75		<b>05.09</b>	PR: 1KZ			
	1.6 FSI	85		<b>01.05</b>	PR: 1KZ			
	1.6 TDI			<b>02.09</b>	PR: 1KZ			
	1.9 TDI	66		<b>05.05</b>	PR: 1KZ			
	1.9 TDI	77		<b>01.05</b>	PR: 1KZ			
	2.0 FSI	110		<b>05.05</b>	PR: 1KZ			
	2.0 TDI			<b>05.05</b>	PR: 1KZ			
	2.0 TDI	81		<b>01.09</b>	PR: 1KZ			
	2.0 TDI	103		<b>01.05</b>	PR: 1KZ			

**VOLKSWAGEN JETTA V (05-10)**

	1.4 TSI	90		<b>05.07</b>	10.10 PR: 12M	<b>BA2155</b>		23131 19,6 +/-WK	<b>VW</b>
	1.4 TSI	103		<b>06.06</b>	10.10 PR: 12M				
	1.4 TSI	118		<b>07.08</b>	10.10 PR: 12M				
	1.4 TSI	125		<b>06.06</b>	10.10 PR: 12M				
	1.6 FSI	85		<b>08.05</b>	10.10 PR: 12M				
	1.6 i 16V	75		<b>08.05</b>	10.10 PR: 12M				
	1.6 TDI			<b>06.09</b>	10.10 PR: 12M				
	1.9 TDI	77		<b>08.05</b>	10.10 PR: 12M				
	2.0 FSI	110		<b>08.05</b>	10.10 PR: 12M				
	2.0 TDI	100		<b>09.05</b>	10.10 PR: 12M				
	2.0 TDI	103		<b>08.05</b>	10.10 PR: 12M				
	2.0 TDI	125		<b>06.06</b>	10.10 PR: 12M				
	2.0 TFSI	147		<b>10.05</b>	10.10 PR: 12M				
	2.5 FSI			<b>07.08</b>	10.10 PR: 12M				
	1.4 TSI	90		<b>05.07</b>	10.10 PR: 12E,12P,12D,1LJ				
1.4 TSI	103		<b>06.06</b>	10.10 PR: 12E,12P,12D,1LJ					
1.4 TSI	118		<b>07.08</b>	10.10 PR: 12E,12P,12D,1LJ					
1.4 TSI	125		<b>06.06</b>	10.10 PR: 12E,12P,12D,1LJ					
1.6 FSI	85		<b>08.05</b>	10.10 PR: 12E,12P,12D,1LJ					
1.6 i 16V	75		<b>08.05</b>	10.10 PR: 12E,12P,12D,1LJ					
1.6 TDI			<b>06.09</b>	10.10 PR: 12E,12P,12D,1LJ					
1.9 TDI	77		<b>08.05</b>	10.10 PR: 12E,12P,12D,1LJ					
2.0 FSI	110		<b>08.05</b>	10.10 PR: 12E,12P,12D,1LJ					
2.0 TDI	100		<b>09.05</b>	10.10 PR: 12E,12P,12D,1LJ					
2.0 TDI	103		<b>08.05</b>	10.10 PR: 12E,12P,12D,1LJ					
2.0 TDI	125		<b>06.06</b>	10.10 PR: 12E,12P,12D,1LJ					
2.0 TFSI	147		<b>10.05</b>	10.10 PR: 12E,12P,12D,1LJ					
2.5 FSI			<b>07.08</b>	10.10 PR: 12E,12P,12D,1LJ					
	1.4 TSI	90		<b>05.07</b>	10.10 PR: 12M	<b>BAR22210</b>		280 22,0 19,0 VL	
	1.4 TSI	103		<b>06.06</b>	10.10 PR: 12M				
	1.4 TSI	118		<b>07.08</b>	10.10 PR: 12M				
	1.4 TSI	125		<b>06.06</b>	10.10 PR: 12M				
	1.6 FSI	85		<b>08.05</b>	10.10 PR: 12M				
	1.6 i 16V	75		<b>08.05</b>	10.10 PR: 12M				
	1.6 TDI			<b>06.09</b>	10.10 PR: 12M				
	1.9 TDI	77		<b>08.05</b>	10.10 PR: 12M				
	2.0 FSI	110		<b>08.05</b>	10.10 PR: 12M				
	2.0 TDI	100		<b>09.05</b>	10.10 PR: 12M				
	2.0 TDI	103		<b>08.05</b>	10.10 PR: 12M				
	2.0 TDI	125		<b>06.06</b>	10.10 PR: 12M				
	2.0 TFSI	147		<b>10.05</b>	10.10 PR: 12M				
	2.5 FSI			<b>07.08</b>	10.10 PR: 12M				
	1.4 TSI	90		<b>05.07</b>	10.10 PR: 12E,12P				<b>BAR25145</b>
1.4 TSI	103		<b>06.06</b>	10.10 PR: 12E,12P					
1.4 TSI	118		<b>07.08</b>	10.10 PR: 12E,12P					
1.4 TSI	125		<b>06.06</b>	10.10 PR: 12E,12P					
1.6 FSI	85		<b>08.05</b>	10.10 PR: 12E,12P					
1.6 i 16V	75		<b>08.05</b>	10.10 PR: 12E,12P					
1.6 TDI			<b>06.09</b>	10.10 PR: 12E,12P					
1.9 TDI	77		<b>08.05</b>	10.10 PR: 12E,12P					
2.0 FSI	110		<b>08.05</b>	10.10 PR: 12E,12P					
2.0 TDI	100		<b>09.05</b>	10.10 PR: 12E,12P					
2.0 TDI	103		<b>08.05</b>	10.10 PR: 12E,12P					
2.0 TDI	125		<b>06.06</b>	10.10 PR: 12E,12P					
2.0 TFSI	147		<b>10.05</b>	10.10 PR: 12E,12P					
2.5 FSI			<b>07.08</b>	10.10 PR: 12E,12P					
1.4 TSI	90		<b>05.07</b>	10.10 PR: 1LJ,12D	<b>BAR25158</b>		312 25,0 22,0 VL		
1.4 TSI	103		<b>06.06</b>	10.10 PR: 1LJ,12D					
1.4 TSI	118		<b>07.08</b>	10.10 PR: 1LJ,12D					
1.4 TSI	125		<b>06.06</b>	10.10 PR: 1LJ,12D					
1.6 FSI	85		<b>08.05</b>	10.10 PR: 1LJ,12D					
1.6 i 16V	75		<b>08.05</b>	10.10 PR: 1LJ,12D					
1.6 TDI			<b>06.09</b>	10.10 PR: 1LJ,12D					

	   kW							
<b>VOLKSWAGEN JETTA V (05-10)</b>								
	1.9 TDI 77 2.0 FSI 110 2.0 TDI 100 2.0 TDI 103 2.0 TDI 125 2.0 TFSI 147 2.5 FSI		08.05 08.05 09.05 08.05 06.06 10.05 07.08	10.10 PR: 1LJ,1ZD 10.10 PR: 1LJ,1ZD 10.10 PR: 1LJ,1ZD 10.10 PR: 1LJ,1ZD 10.10 PR: 1LJ,1ZD 10.10 PR: 1LJ,1ZD 10.10 PR: 1LJ,1ZD	BAR25158			312 25,0 22,0 V L
	1.4 TSI 90 1.4 TSI 103 1.4 TSI 118 1.4 TSI 125 1.6 FSI 85 1.6 i 16V 75 1.6 TDI 1.9 TDI 77 2.0 FSI 110 2.0 TDI 100 2.0 TDI 103 2.0 TDI 125 2.0 TFSI 147 2.5 FSI		05.07 06.06 07.08 06.06 08.05 08.05 06.09 08.05 08.05 09.05 08.05 06.06 10.05 07.08	10.10 PR: 1KE,1KF,1KJ 10.10 PR: 1KE,1KF,1KJ 10.10 PR: 1KE,1KF,1KJ 10.10 PR: 1KE,1KF,1KJ 10.10 PR: 1KE,1KF,1KJ 10.10 PR: 1KE,1KF,1KJ 10.10 PR: 1KE,1KF,1KJ 10.10 PR: 1KE,1KF,1KJ 10.10 PR: 1KE,1KF,1KJ 10.10 PR: 1KE,1KF,1KJ 10.10 PR: 1KE,1KF,1KJ 10.10 PR: 1KE,1KF,1KJ 10.10 PR: 1KE,1KF,1KJ 10.10 PR: 1KE,1KF,1KJ	BA2196			23914 16,3 /WE/S LUC
	1.4 TSI 90 1.4 TSI 103 1.4 TSI 118 1.4 TSI 125 1.6 FSI 85 1.6 i 16V 75 1.6 TDI 1.9 TDI 77 2.0 FSI 110 2.0 TDI 100 2.0 TDI 103 2.0 TDI 125 2.0 TFSI 147 2.5 FSI		05.07 06.06 07.08 06.06 08.05 08.05 06.09 08.05 08.05 09.05 08.05 06.06 10.05 07.08	10.10 PR: 1KE,1KF 10.10 PR: 1KE,1KF 10.10 PR: 1KE,1KF 10.10 PR: 1KE,1KF 10.10 PR: 1KE,1KF 10.10 PR: 1KE,1KF 10.10 PR: 1KE,1KF 10.10 PR: 1KE,1KF 10.10 PR: 1KE,1KF 10.10 PR: 1KE,1KF 10.10 PR: 1KE,1KF 10.10 PR: 1KE,1KF 10.10 PR: 1KE,1KF	BAR12158			256 12,0 10,0
	1.4 TSI 90 1.4 TSI 103 1.4 TSI 118 1.4 TSI 125 1.6 FSI 85 1.6 i 16V 75 1.6 TDI 1.9 TDI 77 2.0 FSI 110 2.0 TDI 100 2.0 TDI 103 2.0 TDI 125 2.0 TFSI 147 2.5 FSI		05.07 06.06 07.08 06.06 08.05 08.05 06.09 08.05 08.05 09.05 08.05 06.06 10.05 07.08	10.10 PR: 1KJ 10.10 PR: 1KJ 10.10 PR: 1KJ 10.10 PR: 1KJ 10.10 PR: 1KJ 10.10 PR: 1KJ 10.10 PR: 1KJ 10.10 PR: 1KJ 10.10 PR: 1KJ 10.10 PR: 1KJ 10.10 PR: 1KJ 10.10 PR: 1KJ 10.10 PR: 1KJ	BAR12169			282 12,0 10,0
<b>VOLKSWAGEN JETTA VI (11-)</b>								
	1.2 TSI 77 1.4 TSI 90 1.4 TSI 118 1.6 TDI 77 2.0 TDI 2.0 TSI 147		04.11 04.11 04.11 04.11 04.11 04.11	PR: 1ZM PR: 1ZM PR: 1ZM PR: 1ZM PR: 1ZM PR: 1ZM	BA2155			23131 19,6 +/WK VW
	1.2 TSI 77 1.4 TSI 90 1.4 TSI 118 1.6 TDI 77 2.0 TDI 2.0 TSI 147		04.11 04.11 04.11 04.11 04.11 04.11	PR: 1ZQ PR: 1ZQ PR: 1ZQ PR: 1ZQ PR: 1ZQ PR: 1ZQ	BA2154			23130 19,6 + VW
	1.2 TSI 77 1.4 TSI 90 1.4 TSI 118 1.6 TDI 77 2.0 TDI 2.0 TSI 147		04.11 04.11 04.11 04.11 04.11 04.11	PR: 1ZA,1ZB,1ZE PR: 1ZA,1ZB,1ZE PR: 1ZA,1ZB,1ZE PR: 1ZA,1ZB,1ZE PR: 1ZA,1ZB,1ZE PR: 1ZA,1ZB,1ZE	BA2195			23587 19,6 +/WK ATE
	1.2 TSI 77 1.4 TSI 90 1.4 TSI 118 1.6 TDI 77 2.0 TDI 2.0 TSI 147		04.11 04.11 04.11 04.11 04.11 04.11	PR: 1ZM PR: 1ZM PR: 1ZM PR: 1ZM PR: 1ZM PR: 1ZM	BAR22210			280 22,0 19,0 V L
	1.2 TSI 77 1.4 TSI 90 1.4 TSI 118 1.6 TDI 77 2.0 TDI 2.0 TSI 147		04.11 04.11 04.11 04.11 04.11 04.11	PR: 1ZQ PR: 1ZQ PR: 1ZQ PR: 1ZQ PR: 1ZQ PR: 1ZQ	BAR22210			280 22,0 19,0 V L
	1.2 TSI 77 1.4 TSI 90 1.4 TSI 118 1.6 TDI 77 2.0 TDI		04.11 04.11 04.11 04.11 04.11	PR: 1ZE,1ZP PR: 1ZE,1ZP PR: 1ZE,1ZP PR: 1ZE,1ZP PR: 1ZE,1ZP	BAR25145			288 24,9 22,0 V L
↓	↓							

								
<b>VOLKSWAGEN JETTA VI (11-)</b>								
	2.0 TSI	147		04.11	PR: 1ZE,1ZP	BAR25145		288 24,9 22,0 V L
	1.2 TSI	77		04.11	PR: 1ZA,1ZB,1LV	BAR25158		312 25,0 22,0 V L
	1.4 TSI	90		04.11	PR: 1ZA,1ZB,1LV			
	1.4 TSI	118		04.11	PR: 1ZA,1ZB,1LV			
	1.6 TDI	77		04.11	PR: 1ZA,1ZB,1LV			
	2.0 TDI			04.11	PR: 1ZA,1ZB,1LV			
	2.0 TSI	147		04.11	PR: 1ZA,1ZB,1LV			
<b>VOLKSWAGEN LT/- 4x4 (75-96)</b>								
	LT 28			04.75	07.96	BA2109		20280 18,5 ATE
	LT 31			04.75	07.96			
	LT 35			04.75	07.96			
	LT 40			08.78	07.96			
	LT 45			08.78	07.96			
	LT 50			12.82	07.96			
	LT 55			08.85	07.96			
	LT 28	◀ 28-B-018541	28-D-007273			BAR20114		281 19,9 18,0
	LT 28	▶ 28-B-019163	28-D-007273					
	LT 28	28-D-007274			07.96			
	LT 31	◀ 28-B-018541	28-D-007273					
	LT 31	▶ 28-B-019163	28-D-007273					
	LT 31	28-D-007274			07.96			
	LT 35	28-B-012411			07.96			
	LT 40	28-B-012411			07.96			
	LT 45	28-B-012411			07.96			
	LT 50				12.82	07.96		
	LT 55				08.85	07.96		
<b>VOLKSWAGEN LT/- 4x4 (96-06)</b>								
	LT 28			05.96	07.06	BA2149		21576 20,5 +/-WE ATE
	LT 35			05.96	07.06	BAV1026	2	Warnkontakt L=80mm
	LT 46			05.96	07.06	BA2239 BAV1008 BAV1026	2 für BA2239 1)	29076 20,0 /WE/Zub PER Warnkontakt L=185mm
						BAV1026	2	Warnkontakt L=80mm
	LT 28			05.96	07.06	BAR22161		276 22,0 19,0 V L
	LT 35			05.96	07.06			
	LT 46			05.96	07.06			
	LT 28			05.96	07.06	BAH0020	2	L=363
	LT 35			05.96	07.06			
	LT 46			05.96	07.06			
	LT 28			05.96	07.06	BA2233 BAV1008	2	21621 17,0 +/-WE ATE Warnkontakt L=185mm
	LT 35			05.96	07.06	BA2215 BAV1008	2	21592 18,5 +/-WE ATE Warnkontakt L=185mm
	LT 35	2D-X-002120	2D-1-040000			BA2216		23021 18,9 /WE BOS
	LT 46			05.96	07.06	BAV1026 BA2239 BAV1008	2 für 13.0460-7909.2 2) für BA2239 1)	Warnkontakt L=80mm 29076 20,0 /WE/Zub PER Warnkontakt L=185mm
	LT 28			05.96	07.06	BAR12142		258 12,0 10,0 L
	LT 35			05.96	07.06	BAR16110		für Baumuster LT 35 3)
	LT 46			05.96	07.06	BAR22196		für Baumuster LT 46 3)
	LT 28			05.96	07.06	BAH0020	2	L=363
	LT 35			05.96	07.06			
	LT 46			05.96	07.06	BAH0020	2	L=363
<b>VOLKSWAGEN LUPO (98-05)</b>								
	1.0			04.98	08.05	PR: 1LM,1ZN,1LB,1ZC	BA2152	21866 17,3 + VW
	1.4	44		09.00	08.05	PR: 1LM,1ZN,1LB,1ZC		
	1.4 16V	55		10.98	08.05	PR: 1LM,1ZN,1LB,1ZC		
	1.4 16V	74		01.99	08.05	PR: 1LM,1ZN,1LB,1ZC		
	1.4 FSI	77		09.00	08.05	PR: 1LM,1ZN,1LB,1ZC		
	1.4 TDI	55		01.99	08.05	PR: 1LM,1ZN,1LB,1ZC		
	1.6 GTI			09.00	08.05	PR: 1LM,1ZN,1LB,1ZC		
	1.7 SDI			04.98	08.05	PR: 1LM,1ZN,1LB,1ZC		
	1.0			04.98	08.05	PR: 1ZE,1ZJ,1ZK,1LX	BA2018	21945 16,3 /S LUC
	1.4	44		09.00	08.05	PR: 1ZE,1ZJ,1ZK,1LX		
	1.4 16V	55		10.98	08.05	PR: 1ZE,1ZJ,1ZK,1LX		
	1.4 16V	74		01.99	08.05	PR: 1ZE,1ZJ,1ZK,1LX		
	1.4 FSI	77		09.00	08.05	PR: 1ZE,1ZJ,1ZK,1LX		
	1.4 TDI	55		01.99	08.05	PR: 1ZE,1ZJ,1ZK,1LX		
	1.6 GTI			09.00	08.05	PR: 1ZE,1ZJ,1ZK,1LX		
	1.7 SDI			04.98	08.05	PR: 1ZE,1ZJ,1ZK,1LX		
	1.0			04.98	08.05	PR: 1LM,1ZN,1LB,1ZC	BAR18106	240 18,0 16,0 V L
	1.4	44		09.00	08.05	PR: 1LM,1ZN,1LB,1ZC		
	1.4 16V	55		10.98	08.05	PR: 1LM,1ZN,1LB,1ZC		
	1.4 16V	74		01.99	08.05	PR: 1LM,1ZN,1LB,1ZC		
	1.4 FSI	77		09.00	08.05	PR: 1LM,1ZN,1LB,1ZC		
	1.4 TDI	55		01.99	08.05	PR: 1LM,1ZN,1LB,1ZC		
	1.6 GTI			09.00	08.05	PR: 1LM,1ZN,1LB,1ZC		
	1.7 SDI			04.98	08.05	PR: 1LM,1ZN,1LB,1ZC		
	1.0			04.98	08.05	PR: 1ZE,1ZJ,1ZK	BAR20128	256 20,0 18,0 V L
	1.4	44		09.00	08.05	PR: 1ZE,1ZJ,1ZK		
	1.4 16V	55		10.98	08.05	PR: 1ZE,1ZJ,1ZK		
	1.4 16V	74		01.99	08.05	PR: 1ZE,1ZJ,1ZK		

1) for BA2239 / per BA2239 / pour BA2239 / para BA2239

2) for 13.0460-7909.2 / per 13.0460-7909.2 / pour 13.0460-7909.2 / para 13.0460-7909.2

3) for design sample / per modello tipo / pour modèle type / para modelo construc

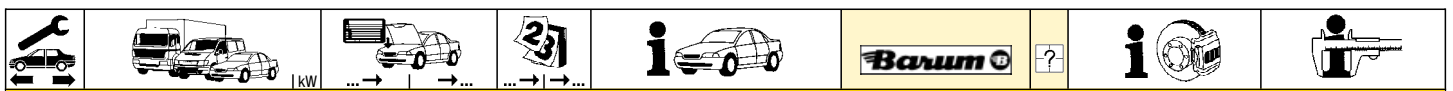

**VOLKSWAGEN LUPO (98-05)**

	1.4 FSI 77 1.4 TDI 55 1.6 GTI 1.7 SDI		09.00 01.99 09.00 04.98	08.05 08.05 08.05 08.05	PR: 1ZE,1ZJ,1ZK PR: 1ZE,1ZJ,1ZK PR: 1ZE,1ZJ,1ZK PR: 1ZE,1ZJ,1ZK	BAR20128		256 20,0 18,0 V L
	1.0 1.4 1.4 16V 1.4 16V 1.4 TDI 1.7 SDI	44 55 74 55	04.98 09.00 10.98 01.99 01.99 04.98	08.05 08.05 08.05 08.05 08.05 08.05		BAH0019	2	L=380
	1.4 16V 1.4 16V 1.4 FSI 1.4 FSI 1.6 GTI 1.6 GTI	74 74 77 77	6X-2-080000 01.99 6E-2-010000 01.99 6X-2-080000 09.00 6E-2-010000 09.00 6X-2-080000 09.00 6E-2-010000 09.00			BA2017 BA2032		20961 17,2 /S 20961 15,2 /S LUC LUC
	1.4 16V 1.4 FSI 1.6 GTI	74 77	01.99 09.00 09.00	08.05 08.05 08.05		BAR09124		232 8,9 7,0
	1.0 1.2 TDI 3L 1.4 1.4 16V 1.4 16V 1.4 FSI 1.4 TDI 1.6 GTI 1.7 SDI	45 44 55 74 77 55	04.98 06.99 09.00 10.98 01.99 09.00 01.99 09.00 04.98	08.05 08.05 08.05 08.05 08.05 08.05 08.05 08.05		BAH0033	2	L=140
	1.0 1.2 TDI 3L 1.4 1.4 16V 1.4 TDI 1.7 SDI	45 44 55 55	04.98 06.99 09.00 10.98 01.99 04.98	08.05 08.05 08.05 08.05 08.05 08.05	- ABS - ABS - ABS - ABS - ABS	BAW1501		Rz 15,87
	1.0 1.4 1.4 16V 1.4 TDI 1.7 SDI	44 55 55	04.98 09.00 10.98 01.99 04.98	08.05 08.05 08.05 08.05 08.05	+ ABS + ABS + ABS + ABS + ABS	BAW1701		Rz 17,46
	1.0 1.4 16V 1.4 TDI 1.7 SDI	55 55	6X-X-003000 04.98 6X-X-003000 10.98 6X-X-003000 01.99 6X-X-003000 04.98			BAE5003		180 x 31 HEB
	1.0 1.4 1.4 16V 1.4 TDI 1.7 SDI	6X-X-003001 44 55 55 6X-X-003001	09.00	08.05 08.05 08.05 08.05		BAE5001		200 x 40 HEB VW

**VOLKSWAGEN NEW BEETLE (98-10)**

	1.9 TDI 2.0	66 85	9C-X-999000 01.98 9C-X-999000 01.98		PR: 1ZM PR: 1ZM	BA2154		23130 19,6 + VW
	1.4 1.6 1.8 T 1.8 T 1.9 TDI 1.9 TDI 1.9 TDI 2.0	55 110 132 66 74 77 85	08.01 11.99 10.99 11.01 10.00 07.05 05.10	05.10 05.10 05.10 06.05 02.01 05.10 05.10 05.10	PR: 1ZP,1ZM PR: 1ZP,1ZM PR: 1ZP,1ZM PR: 1ZP,1ZM PR: 1ZP,1ZM PR: 1ZP,1ZM PR: 1ZP,1ZM PR: 1ZP,1ZM	BA2155		23131 19,6 +/-WK VW
	1.9 TDI 2.0	66 85	9C-X-699000 01.98 9C-X-699000 01.98		PR: 1ZE,1ZH PR: 1ZE,1ZH	BA2333		21911 20,3 + ATE
	1.4 1.6 1.8 T 1.8 T 1.9 TDI 1.9 TDI 1.9 TDI 2.0 2.3 V5 3.2 RSI	55 110 132 66 74 77 85 125	08.01 11.99 10.99 11.01 10.00 07.05 05.10 10.00 04.00	05.10 05.10 05.10 06.05 02.01 05.10 05.10 05.10 03.03	PR: 1ZD,1ZE PR: 1ZD,1ZE PR: 1ZD,1ZE PR: 1ZD,1ZE PR: 1ZD,1ZE PR: 1ZD,1ZE PR: 1ZD,1ZE PR: 1ZD,1ZE PR: 1ZD,1ZE	BA2205		23392 20,6 +/-WK ATE
	1.4 1.6 1.8 T 1.8 T 1.9 TDI 1.9 TDI 1.9 TDI 2.0	55 110 132 66 74 77 85	08.01 11.99 10.99 11.01 01.98 10.00 07.05 01.98	05.10 05.10 05.10 06.05 02.01 05.10 05.10 05.10	PR: 1ZP,1ZM PR: 1ZP,1ZM PR: 1ZP,1ZM PR: 1ZP,1ZM PR: 1ZP,1ZM PR: 1ZP,1ZM PR: 1ZP,1ZM PR: 1ZP,1ZM	BAR22150		280 22,0 19,0 V L
	1.4 1.6 1.8 T 1.8 T 1.9 TDI 1.9 TDI	55 110 132 66	08.01 11.99 10.99 11.01 01.98	05.10 05.10 05.10 06.05 02.01	PR: 1ZD,1ZE PR: 1ZD,1ZE PR: 1ZD,1ZE PR: 1ZD,1ZE PR: 1ZD,1ZE	BAR25113		288 25,0 22,0 V L



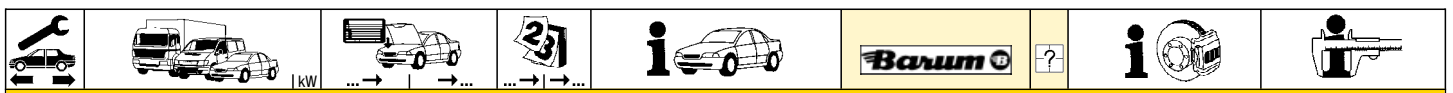

















**VOLKSWAGEN NEW BEETLE (98-10)**

	1.9 TDI	74		10.00	05.10	PR: 1ZD,1ZE	BAR25113		288 25,0 22,0 V L
	1.9 TDI	77		07.05	05.10	PR: 1ZD,1ZE			
	2.0	85		01.98	05.10	PR: 1ZD,1ZE			
	2.3 V5	125		10.00	12.05		BAR25123		312 25,0 23,0 V L
	3.2 RSI			04.00	03.03				
	1.4	55		08.01	05.10		BAH0023	2	L=435
	1.6			11.99	05.10				
	1.8 T	110		10.99	05.10				
	1.8 T	132		11.01	06.05				
	1.9 TDI	66		01.98	02.01				
	1.9 TDI	74		10.00	05.10				
	1.9 TDI	77		07.05	05.10				
	2.0	85		01.98	05.10				
	2.3 V5	125		10.00	05.05				
	3.2 RSI			04.00	03.03				
	1.4	55		08.01	05.10	PR: 1KS,1KV	BA2017		20961 17,2 /S LUC
	1.6			11.99	05.10	PR: 1KS,1KV			
	1.8 T	110		10.99	05.10	PR: 1KS,1KV			
	1.8 T	132		11.01	06.05	PR: 1KS,1KV			
	1.9 TDI	66		01.98	02.01	PR: 1KS,1KV			
	1.9 TDI	74		10.00	05.10	PR: 1KS,1KV			
	1.9 TDI	77		07.05	05.10	PR: 1KS,1KV			
	2.0	85		01.98	05.10	PR: 1KS,1KV			
	2.3 V5	125		10.00	05.05	PR: 1KS,1KV			
	1.8 T	132		11.01	06.05	PR: 1KY	BA2032		20961 15,2 /S LUC
	2.3 V5	125		10.00	05.05	PR: 1KY			
	3.2 RSI			04.00	03.03				
	1.4	55		08.01	05.10	PR: 1KS,1KV	BAR09123		232 8,9 7,0
	1.6			11.99	05.10	PR: 1KS,1KV			
	1.8 T	110		10.99	05.10	PR: 1KS,1KV			
	1.8 T	132		11.01	06.05	PR: 1KS,1KV			
	1.9 TDI	66		01.98	02.01	PR: 1KS,1KV			
	1.9 TDI	74		10.00	05.10	PR: 1KS,1KV			
	1.9 TDI	77		07.05	05.10	PR: 1KS,1KV			
	2.0	85		01.98	05.10	PR: 1KS,1KV			
	1.8 T	132		11.01	06.05	PR: 1KY	BAR22163		256 22,0 20,0 V L
	2.3 V5	125		10.00	05.05	PR: 1KY			
	3.2 RSI			04.00	03.03				
	1.4	55		08.01	05.10		BAH0033	2	L=140
	1.6			11.99	05.10				
	1.8 T	110		10.99	05.10				
	1.8 T	132		11.01	05.10				
	1.9 TDI	66		01.98	05.10				
	1.9 TDI	74		10.00	05.10				
	1.9 TDI	77		07.05	05.10				
	2.0	85		01.98	05.10				
	2.3 V5	125		10.00	05.10				
	3.2 RSI			04.00	05.10				

**VOLKSWAGEN NEW BEETLE Cabriolet (03-10)**

	1.4	55		01.03	05.10	PR: 1ZP,1ZM	BA2155		23131 19,6 +/-WK VW
	1.6	75		01.03	05.10	PR: 1ZP,1ZM			
	1.8 T	110		12.03	05.10	PR: 1ZP,1ZM			
	1.9 TDI	74		07.03	05.10	PR: 1ZP,1ZM			
	1.9 TDI	77		07.05	05.10	PR: 1ZP,1ZM			
	2.0	85		01.03	05.10	PR: 1ZP,1ZM			
	1.4	55		01.03	05.10	PR: 1ZD,1ZE	BA2205		23392 20,6 +/-WK ATE
	1.6	75		01.03	05.10	PR: 1ZD,1ZE			
	1.8 T	110		12.03	05.10	PR: 1ZD,1ZE			
	1.9 TDI	74		07.03	05.10	PR: 1ZD,1ZE			
	1.9 TDI	77		07.05	05.10	PR: 1ZD,1ZE			
	2.0	85		01.03	05.10	PR: 1ZD,1ZE			
	1.4	55		01.03	05.10	PR: 1ZP,1ZM	BAR22150		280 22,0 19,0 V L
	1.6	75		01.03	05.10	PR: 1ZP,1ZM			
	1.8 T	110		12.03	05.10	PR: 1ZP,1ZM			
	1.9 TDI	74		07.03	05.10	PR: 1ZP,1ZM			
	1.9 TDI	77		07.05	05.10	PR: 1ZP,1ZM			
	2.0	85		01.03	05.10	PR: 1ZP,1ZM			
	1.4	55		01.03	05.10	PR: 1ZD,1ZE	BAR25113		288 25,0 22,0 V L
	1.6	75		01.03	05.10	PR: 1ZD,1ZE			
	1.8 T	110		12.03	05.10	PR: 1ZD,1ZE			
	1.9 TDI	74		07.03	05.10	PR: 1ZD,1ZE			
	1.9 TDI	77		07.05	05.10	PR: 1ZD,1ZE			
	2.0	85		01.03	05.10	PR: 1ZD,1ZE			
	1.4	55		01.03	05.10		BAH0023	2	L=435
	1.6	75		01.03	05.10				
	1.8 T	110		12.03	05.10				
	1.9 TDI	74		07.03	05.10				
	1.9 TDI	77		07.05	05.10				
	2.0	85		01.03	05.10				
	1.4	55		01.03	05.10	PR: 1KS,1KV	BA2017		20961 17,2 /S LUC
	1.6	75		01.03	05.10	PR: 1KS,1KV			
	1.8 T	110		12.03	05.10	PR: 1KS,1KV			
	1.9 TDI	74		07.03	05.10	PR: 1KS,1KV			
	1.9 TDI	77		07.05	05.10	PR: 1KS,1KV			
	2.0	85		01.03	05.10	PR: 1KS,1KV			
↓	↓								

								
<b>VOLKSWAGEN NEW BEETLE Cabriolet (03-10)</b>								
	2.0	85	01.03	05.10	PR: 1KS,1KV	BA2017		20961 17,2 /S LUC
	1.4	55	01.03	05.10	PR: 1KS,1KV	BAR09123		232 8,9 7,0
	1.6	75	01.03	05.10	PR: 1KS,1KV			
	1.8 T	110	12.03	05.10	PR: 1KS,1KV			
	1.9 TDI	74	07.03	05.10	PR: 1KS,1KV			
	2.0	85	01.03	05.10	PR: 1KS,1KV			
	1.4	55	01.03	05.10		BAH0033	2	L=140
	1.6	75	01.03	05.10				
	1.8 T	110	12.03	05.10				
	1.9 TDI	74	07.03	05.10				
	2.0	85	01.03	05.10				
<b>VOLKSWAGEN BEETLE (11-)</b>								
	1.2 TSI	77	10.11		PR: 1ZQ	BA2154		23130 19,6 + VW
	1.4 TSI	118	10.11		PR: 1ZQ			
	1.6 TDI	77	10.11		PR: 1ZQ			
	2.0 TDI	103	10.11		PR: 1ZQ			
	2.0 TSI	147	10.11		PR: 1ZQ			
	1.2 TSI	77	10.11		PR: 1ZB,1ZE	BA2195		23587 19,6 +/WK ATE
	1.4 TSI	118	10.11		PR: 1ZB,1ZE			
	1.6 TDI	77	10.11		PR: 1ZB,1ZE			
	2.0 TDI	103	10.11		PR: 1ZB,1ZE			
	2.0 TSI	147	10.11		PR: 1ZB,1ZE			
	1.2 TSI	77	10.11		PR: 1LV,1ZM,1ZP	BA2155		23131 19,6 +/WK VW
	1.4 TSI	118	10.11		PR: 1LV,1ZM,1ZP			
	1.6 TDI	77	10.11		PR: 1LV,1ZM,1ZP			
	2.0 TDI	103	10.11		PR: 1LV,1ZM,1ZP			
	2.0 TSI	147	10.11		PR: 1LV,1ZM,1ZP			
	1.2 TSI	77	10.11		PR: 1ZQ	BAR22210		280 22,0 19,0 V L
	1.4 TSI	118	10.11		PR: 1ZQ			
	1.6 TDI	77	10.11		PR: 1ZQ			
	2.0 TDI	103	10.11		PR: 1ZQ			
	2.0 TSI	147	10.11		PR: 1ZQ			
	1.2 TSI	77	10.11		PR: 1ZM	BAR22210		280 22,0 19,0 V L
	1.4 TSI	118	10.11		PR: 1ZM			
	1.6 TDI	77	10.11		PR: 1ZM			
	2.0 TDI	103	10.11		PR: 1ZM			
	2.0 TSI	147	10.11		PR: 1ZM			
	1.2 TSI	77	10.11		PR: 1ZE,1ZP	BAR25145		288 24,9 22,0 V L
	1.4 TSI	118	10.11		PR: 1ZE,1ZP			
	1.6 TDI	77	10.11		PR: 1ZE,1ZP			
	2.0 TDI	103	10.11		PR: 1ZE,1ZP			
	2.0 TSI	147	10.11		PR: 1ZE,1ZP			
<b>VOLKSWAGEN PASSAT (88-93)</b>								
	1.6 Limousine		04.88	09.89	- ABS	BA2038 BA2132		20168 19,6 /S LUC 20887 19,7 +/Zub VW
	1.6 Limousine		10.89	10.93	- ABS	BA2038		20168 19,6 /S LUC
	1.6 Limousine		04.88	10.93	+ ABS			
	1.6 TD		08.88	10.93				
	1.6 Variant		04.88	10.93				
	1.8	55	04.88	10.93				
	1.8	66	04.88	10.93				
	1.8 Syncro G60		08.88	10.93				
	1.9 D		05.89	10.93				
	1.9 TD		03.91	10.93				
	2.8 VR6		06.91	10.93				
	1.8	79	04.88	07.90		BA2037		20168 16,3 /S LUC
	1.8	82	04.88	07.90				
	1.8 16V		04.88	07.92				
	2.0		03.90	10.93				
	2.0 16V		08.88	10.93				
	2.0 Syncro		10.90	10.93				
	2.8 VR6	31-N-255990		10.93				
	1.6		04.88	10.93		BAR13178		256 12,9 11,0
	1.6 TD		08.88	10.93				
	1.8	55	04.88	10.93				
	1.8	66	04.88	10.93				
	1.9 D		05.89	10.93				
	1.9 TD		03.91	10.93				
	1.8	79	04.88	07.90		BAR20128		256 20,0 18,0 V L
	1.8	82	04.88	07.90				
	1.8 16V		04.88	07.92				
	2.0		03.90	10.93				
	2.0 16V		08.88	10.93				
	2.0 Syncro		10.90	10.93				
	2.8 VR6	31-N-255990		10.93				
	1.6		04.88	10.93		BAH0014	2	L=330
	1.6 TD		08.88	10.93				
	1.8		04.88	10.93				
	1.8 16V		04.88	07.92				
	1.8 Syncro G60		08.88	10.93				

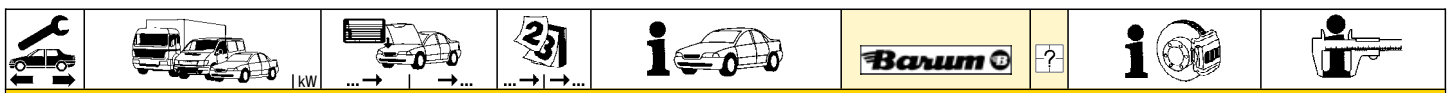

**VOLKSWAGEN PASSAT (88-93)**

	1.9 D 1.9 TD 2.0 2.0 16V 2.0 Syncro 2.8 VR6			05.89 03.91 03.90 08.88 10.90 06.91	10.93 10.93 10.93 10.93 10.93 10.93	BAH0014	2		L=330
	1.8 1.8 1.8 16V 1.8 Syncro G60 2.0 2.0 2.0 16V 2.0 16V 2.0 Syncro 2.8 VR6 2.8 VR6	79 82		04.88 04.88 04.88 08.88 03.90 03.90 08.88 08.88 10.90 06.91	07.90 07.90 07.92 08.88 03.90 03.90 08.88 08.88 10.90 06.91	BA2032			20961 15,2 /S LUC
	1.8 Syncro G60 2.0 2.0 2.0 16V 2.0 16V 2.0 Syncro 2.8 VR6 2.8 VR6		31-P-080001 31-PE080001 31-PB080001 31-PE080001 31-PB080001 31-P-080001 31-PE080001 31-PB080001		10.93 10.93 10.93 10.93 10.93 10.93 10.93	BA2017			20961 17,2 /S LUC
	1.8 1.8 1.8 16V 2.0 2.0 16V 1.8 Syncro G60 2.0 Syncro 2.8 VR6	79 82		04.88 04.88 04.88 03.90 08.88 08.88 10.90 06.91	07.90 07.90 07.92 10.93 10.93 10.93 10.93 10.93	BAR10111		ohne Sensorring <sup>1)</sup>	226 10,0 8,0
	1.8 Syncro G60 2.0 Syncro 2.8 VR6			08.88 10.90 06.91	10.93 10.93 10.93	BAR10151			239 9,9 8,0
	2.8 VR6			06.91	10.93	BAR10203			226 10,0 8,0
	1.6 1.6 TD 1.8 1.8 1.9 D 1.9 TD 1.8 1.8 2.0 2.0 16V 2.8 VR6 1.8 Syncro G60 2.0 Syncro	55 66		04.88 08.88 04.88 04.88 05.89 03.91 04.88 04.88 03.90 08.88 06.91 08.88 10.90	10.93 10.93 10.93 10.93 10.93 10.93 07.90 07.90 10.93 10.93 10.93 10.93 10.93	BAH0015	2		L=180
	1.8 1.8 2.0 2.0 16V 2.8 VR6	79 82		04.88 04.88 03.90 08.88 06.91	07.90 07.90 10.93 10.93 10.93	BAH0015 BAH0003	2 2	am Bremssattel <sup>2)</sup>	L=180 L=160
	1.8 Syncro G60 2.0 Syncro			08.88 10.90	10.93 10.93	BAH0011 BAH0003	2 2	am Bremssattel <sup>2)</sup>	L=160 L=160
	1.6 Limousine 1.6 Limousine 1.6 TD 1.6 Variant 1.8 1.8 1.9 D 1.9 TD		31-L-085000	04.88	10.93	BAW1905 BAW2004			Rz 19,05 Rz 20,64
	1.6 Limousine 1.6 Limousine 1.6 TD 1.6 Variant 1.8 1.8 1.9 D 1.9 TD		31-L-085001	04.88	10.93	BAE5001 BAE5006			200 x 40 HEB VW 230 x 40 HEB VW
	1.6 Limousine 1.6 TD 1.6 Variant 1.8 1.8 1.9 D 1.9 TD	55 66	31-M-280000 31-M-280000 31-M-280000 31-M-280000 31-M-280000 31-M-280000	04.88 08.88 04.88 04.88 04.88 05.89	10.93 10.93 10.93 10.93 10.93 10.93	BAE5006			230 x 40 HEB VW

**VOLKSWAGEN PASSAT (94-96)**

	1.6 1.8 1.9 TD 1.9 TDI 1.9 TDI 1.6 1.9 TDI 2.0 2.0 Syncro 2.0 16V 2.8 VR6 2.9 VR6 Syncro	55 66 81	3A-T-130756 3A-S-300000	10.94 10.93 10.93 10.93 03.96 12.96 10.93 01.94 01.94 10.93 10.94	12.96 12.96 12.96 12.96 12.96 12.96 12.96 12.96 12.96 12.96 12.96	BA2038			20168 19,6 /S LUC
	1.6 1.9 TDI 2.0 2.0 Syncro	66	3A-T-130757 3A-T-000001		12.96 12.96 12.96 12.96	BA2037			20168 16,3 /S LUC
	2.0 16V 2.8 VR6 2.9 VR6 Syncro			01.94 10.93 10.94	12.96 12.96 12.96	BA2333			21911 20,3 + ATE

<sup>1)</sup> without sensor ring / senza sensori / sans secours ABS / sin anillo sensor ABS  
<sup>2)</sup> on the brake caliper / sulla pinza freno / sur l'étrier de frein / a la pinza de freno

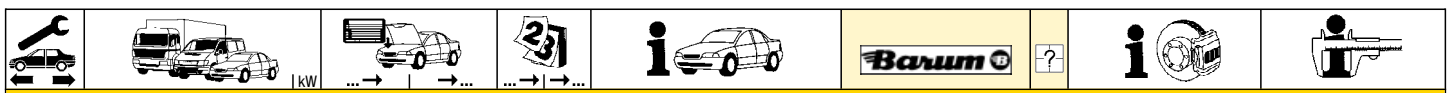

**VOLKSWAGEN PASSAT (94-96)**

	1.6		3A-T-130756	10.94		BAR13178		256 12,9 11,0
	1.8			10.93	12.96			
	1.9 TD	55		10.93	12.96			
	1.9 TDI	66	3A-S-300000	10.93				
	1.6		3A-T-130757		12.96	BAR20128		256 20,0 18,0 V L
	1.9 TDI	66	3A-T-000001		12.96			
	2.0			10.93	12.96			
	2.0 Syncro			01.94	12.96			
	1.9 TDI	81		03.96	12.96	BAR22100		280 22,0 20,0 V L
	1.6			10.94	12.96	BAH0014	2	L=330
	1.8			10.93	12.96			
	1.9 TD	55		10.93	12.96			
	1.9 TDI			10.93	12.96			
	2.0			10.93	12.96			
	2.0 Syncro			01.94	12.96			
	2.0 16V			01.94	12.96	BAH0019	2	L=380
	2.8 VR6			10.93	12.96			
	2.9 VR6 Syncro			10.94	12.96			
	1.9 TDI	66	3A-T-000001		12.96	BA2017		20961 17,2 /S LUC
	1.9 TDI	81		03.96	12.96			
	2.0			10.93	12.96			
	2.0 16V			01.94	12.96			
	2.0 Syncro			01.94	12.96			
	2.8 VR6			10.93	12.96			
	2.9 VR6 Syncro			10.94	12.96			
	1.9 TDI	66	3A-T-000001		12.96	BAR10111		226 10,0 8,0
	2.0			10.93	12.96			
	1.9 TDI	81		03.96	12.96	BAR10203		226 10,0 8,0
	2.0 16V			01.94	12.96			
	2.8 VR6			10.93	12.96			
	2.0 Syncro			01.94	12.96	BAR10151		239 9,9 8,0
	1.6			10.94	12.96	BAH0011	2	L=160
	1.8			10.93	12.96			
	1.9 TD	55		10.93	12.96			
	1.9 TDI	66	3A-S-300000	10.93				
	1.9 TDI	66	3A-T-000001		12.96	BAH0011	2	L=160
	1.9 TDI	81		03.96	12.96			
	2.0			10.93	12.96	BAH0003	2	L=160
	2.0 16V			01.94	12.96		am Bremssattel 2)	L=160
	2.0 Syncro			01.94	12.96			
	2.8 VR6			10.93	12.96			
	2.9 VR6 Syncro			10.94	12.96			
	1.6			10.94	12.96	BAW2004		Rz 20,64
	1.8			10.93	12.96			
	1.9 TD	55		10.93	12.96			
	1.9 TDI	66	3A-S-300000	06.95				
	1.6			10.94	12.96	BAE5006		230 x 40 HEB VW
	1.8			10.93	12.96			
	1.9 TD	55		10.93	12.96			
	1.9 TDI	66	3A-S-300000	10.93				

**VOLKSWAGEN PASSAT (97-05)**

	1.6		3B-X-600000	10.96	PR: 1LZ,1ZJ	BA2160		21945 19,6 /S LUC
	1.8	85	3B-X-600000	01.97	+ (M) / + GUS-Staaten 3)			
	1.8	92	3B-X-600000	10.96	PR: 1LZ,1ZJ			
	1.8 4motion		3B-X-600000	10.96	PR: 1LZ,1ZJ			
	1.9 TDI	66	3B-X-600000	10.96	PR: 1LZ,1ZJ			
	1.6		3B-Y-000001		09.00 PR: 1LZ,1ZJ	BA2198		21945 19,6 +/WK/S LUC
	1.8	85	3B-Y-000001		09.00 + (M) / + GUS-Staaten 3)			
	1.8	92	3B-Y-000001		09.00 PR: 1LZ,1ZJ			
	1.8 4motion		3B-Y-000001		09.00 PR: 1LZ,1ZJ			
	1.9 TDI	66	3B-Y-000001		09.00 PR: 1LZ,1ZJ			
	1.6		3B-X-600000	10.96	PR: 1LB,1ZC	BA2148		21624 20,6 + ATE
	1.8	92	3B-X-600000	10.96	PR: 1LB,1ZC			
	1.8 4motion		3B-X-600000	10.96	PR: 1LB,1ZC			
	1.8 T		3B-X-600000	10.96	PR: 1LB,1ZC			
	1.9 TDI	66	3B-X-600000	10.96	PR: 1LB,1ZC			
	1.9 TDI	81	3B-X-600000	10.96	PR: 1LB,1ZC			
	1.9 TDI	85	3B-X-600000	08.98	PR: 1LB,1ZC			
	1.9 TDI 4motion		3B-X-600000	10.96	PR: 1LB,1ZC			
	2.3		3B-X-600000	10.96	PR: 1LB,1ZC			
	2.3 4motion		3B-X-600000	06.97	PR: 1LB,1ZC			
	2.5 TDI		3B-X-600000	08.98	PR: 1LB,1ZC			
	2.5 TDI 4motion		3B-X-600000	08.98	PR: 1LB,1ZC			
	2.8	132	3B-X-600000	01.97	+ (M) / + GUS-Staaten 3)			
	2.8	142	3B-X-600000	08.96	PR: 1LB,1ZC			
	2.8 4motion		3B-X-600000	10.96	PR: 1LB,1ZC			
	1.6		3B-Y-000001		06.05 PR: 1LB,1ZC	BA2172		23018 20,6 +/WK ATE
	1.8	92	3B-Y-000001		06.05 PR: 1LB,1ZC			
	1.8 4motion		3B-Y-000001		06.05 PR: 1LB,1ZC			
	1.8 T		3B-Y-000001		06.05 PR: 1LB,1ZC			
	1.9 TDI	66	3B-Y-000001		06.05 PR: 1LB,1ZC			
	1.9 TDI	74		10.00	06.05 PR: 1LB,1ZC			
	1.9 TDI	81	3B-Y-000001		06.05 PR: 1LB,1ZC			
	1.9 TDI	85	3B-Y-000001		06.05 PR: 1LB,1ZC			

1) without sensor ring / senza sensori / sans secours ABS / sin anillo sensor ABS  
 2) on the brake caliper / sulla pinza freno / sur l'étrier de frein / a la pinza de freno  
 3) + (M) / + GUS States / + (M) / + Stati del GUS / + (M) / + Etats de la CEI / + (M) / + estados del GUS





**VOLKSWAGEN PASSAT (97-05)**

	1.9 TDI	96		10.00	06.05	PR: 1LB,1ZC	BA2172		23018 20,6 +/WK	ATE
	1.9 TDI 4motion	3B-Y-000001			06.05	PR: 1LB,1ZC				
	1.9 TDI 4motion	96		10.00	06.05	PR: 1LB,1ZC				
	2.0	85		10.00	06.05	PR: 1LB,1ZC				
	2.0	96		05.02	06.05	PR: 1LB,1ZC				
	2.0 4motion	85		10.00	06.05	PR: 1LB,1ZC				
	2.0 TDI	100		12.03	06.05	PR: 1LB,1ZC				
	2.3	3B-Y-000001			06.05	PR: 1LB,1ZC				
	2.3 4motion	3B-Y-000001			06.05	PR: 1LB,1ZC				
	2.5 TDI	3B-Y-000001			06.05	PR: 1LB,1ZC				
	2.5 TDI 4motion	3B-Y-000001			06.05	PR: 1LB,1ZC				
	2.8	132 3B-Y-000001			06.05 +  / + GUS-Staaten <sup>1)</sup>					
	2.8	142 3B-Y-000001			06.05	PR: 1LB,1ZC				
	2.8 4motion	3B-Y-000001			06.05	PR: 1LB,1ZC				
		1.6	3B-Y-000001			06.05				
1.8		92 3B-Y-000001			06.05	PR: 1LE, 1LT				
1.8 4motion		3B-Y-000001			06.05	PR: 1LE, 1LT				
1.8 T		3B-Y-000001			06.05	PR: 1LE, 1LT				
1.9 TDI		66 3B-Y-000001			06.05	PR: 1LE, 1LT				
1.9 TDI		74		10.00	06.05	PR: 1LE, 1LT				
1.9 TDI		81 3B-Y-000001			06.05	PR: 1LE, 1LT				
1.9 TDI		85 3B-Y-000001			06.05	PR: 1LE, 1LT				
1.9 TDI		96		10.00	06.05	PR: 1LE, 1LT				
1.9 TDI 4motion		3B-Y-000001			06.05	PR: 1LE, 1LT				
1.9 TDI 4motion		96		10.00	06.05	PR: 1LE, 1LT				
2.0		85		10.00	06.05	PR: 1LE, 1LT				
2.0		96		05.02	06.05	PR: 1LE, 1LT				
2.0 4motion		85		10.00	06.05	PR: 1LE, 1LT				
2.0 TDI		100		12.03	06.05	PR: 1LE, 1LT				
2.3		3B-Y-000001			06.05	PR: 1LE, 1LT				
2.3 4motion		3B-Y-000001			06.05	PR: 1LE, 1LT				
2.5 TDI		3B-Y-000001			06.05	PR: 1LE, 1LT				
2.5 TDI 4motion		3B-Y-000001			06.05	PR: 1LE, 1LT				
2.8		132 3B-Y-000001			06.05 +  / + GUS-Staaten <sup>1)</sup>					
2.8		142 3B-Y-000001			06.05	PR: 1LE, 1LT				
2.8 4motion	3B-Y-000001			06.05	PR: 1LE, 1LT					
	1.6			10.96	09.00	PR: 1LZ,1ZJ	BAR22152		280 22,0 20,0 V L	
	1.8	85		01.97	09.00 +  / + GUS-Staaten <sup>1)</sup>					
	1.8	92		10.96	09.00	PR: 1LZ,1ZJ				
	1.8 4motion			10.96	09.00	PR: 1LZ,1ZJ				
	1.9 TDI	66		10.96	09.00	PR: 1LZ,1ZJ				
	1.6		3B-X-124107	10.96		PR: 1LB,1ZC	BAR25115		283 25,0 23,0 V L	
	1.8	92	3B-X-124107	10.96		PR: 1LB,1ZC				
	1.8 4motion		3B-X-124107	10.96		PR: 1LB,1ZC				
	1.8 T		3B-X-124107	10.96		PR: 1LB,1ZC				
	1.9 TDI	66	3B-X-124107	10.96		PR: 1LB,1ZC				
	1.9 TDI	81	3B-X-124107	10.96		PR: 1LB,1ZC				
	1.9 TDI	85	3B-X-124107	08.98		PR: 1LB,1ZC				
	1.9 TDI 4motion		3B-X-124107	10.96		PR: 1LB,1ZC				
	2.3		3B-X-124107	10.96		PR: 1LB,1ZC				
	2.3 4motion		3B-X-124107	06.97		PR: 1LB,1ZC				
	2.8	132	3B-X-124107	01.97		+  / + GUS-Staaten <sup>1)</sup>				
	2.8	142	3B-X-124107	08.96		PR: 1LB,1ZC				
2.8 4motion		3B-X-124107	10.96		PR: 1LB,1ZC					
	1.6		3B-X-124108		06.05	PR: 1LB,1LE,1ZC	BAR25171		288 25,0 23,0 V L	
	1.8	92	3B-X-124108		06.05	PR: 1LB,1LE,1ZC				
	1.8 4motion		3B-X-124108		06.05	PR: 1LB,1LE,1ZC				
	1.8 T		3B-X-124108		06.05	PR: 1LB,1LE,1ZC				
	1.9 TDI	66	3B-X-124108		06.05	PR: 1LB,1LE,1ZC				
	1.9 TDI	74		10.00	06.05	PR: 1LB,1LE,1ZC				
	1.9 TDI	81	3B-X-124108		06.05	PR: 1LB,1LE,1ZC				
	1.9 TDI	85	3B-X-124108		06.05	PR: 1LB,1LE,1ZC				
	1.9 TDI	96		10.00	06.05	PR: 1LB,1LE,1ZC				
	1.9 TDI 4motion		3B-X-124108		06.05	PR: 1LB,1LE,1ZC				
	1.9 TDI 4motion	96		10.00	06.05	PR: 1LB,1LE,1ZC				
	2.0	85		10.00	06.05	PR: 1LB,1LE,1ZC				
	2.0	96		05.02	06.05	PR: 1LB,1LE,1ZC				
	2.0 4motion	85		10.00	06.05	PR: 1LB,1LE,1ZC				
	2.0 TDI	100		12.03	06.05	PR: 1LB,1LE,1ZC				
	2.3		3B-X-124108		09.00	PR: 1LB,1LE,1ZC				
	2.3 4motion		3B-X-124108		09.00	PR: 1LB,1LE,1ZC				
	2.5 TDI			08.98	09.00	PR: 1LB,1LE,1ZC				
2.5 TDI 4motion			08.98	09.00	PR: 1LB,1LE,1ZC					
2.8	132	3B-X-124108		06.05 +  / + GUS-Staaten <sup>1)</sup>						
2.8	142	3B-X-124108		09.00	PR: 1LB,1LE,1ZC					
2.8 4motion		3B-X-124108		09.00	PR: 1LB,1LE,1ZC					
	1.6			10.96	06.05		BAH0013	2	L=295	
	1.8	85		01.97	09.00 +  / + GUS-Staaten <sup>1)</sup>					
	1.8	92		10.96	09.00					
	1.8 4motion			10.96	09.00					
	1.8 T			10.96	06.05					
	1.9 TDI	66		10.96	09.00					
	1.9 TDI	74		10.00	06.05					
	1.9 TDI	81		10.96	06.05					
	1.9 TDI	85		08.98	06.05					
	1.9 TDI	96		10.00	06.05					
1.9 TDI 4motion			10.96	06.05						















1) + / + GUS States / + / + Stati del GUS / + / + Etats de la CEI / + / + estados del GUS

VOLKSWAGEN PASSAT (97-05)		VOLKSWAGEN PASSAT Limousine (05-10)							
<b>VOLKSWAGEN PASSAT (97-05)</b>		<b>VOLKSWAGEN PASSAT Limousine (05-10)</b>							
	1.9 TDI 4motion 96 2.0 85 2.0 96 2.0 4motion 85 2.0 TDI 100 2.3 2.3 4motion 2.5 TDI 2.5 TDI 4motion 2.8 132 2.8 142 2.8 4motion	10.00 06.05 10.00 06.05 05.02 06.05 10.00 06.05 12.03 06.05 10.96 06.05 06.97 06.05 08.98 06.05 08.98 06.05 01.97 06.05 +  / + GUS-Staaten 1) 08.96 06.05 10.96 06.05	BAH0013	2			L=295		
	1.6 85 1.8 92 1.8 1.8 4motion 1.8 T 1.9 TDI 66 1.9 TDI 74 1.9 TDI 81 1.9 TDI 85 1.9 TDI 96 1.9 TDI 4motion 1.9 TDI 4motion 96 2.0 85 2.0 96 2.0 4motion 85 2.0 TDI 100 2.3 2.3 4motion 2.5 TDI 2.5 TDI 4motion 2.8 132 2.8 142 2.8 4motion 4.0 W8 4motion	10.96 06.05 PR: 1KD,1KE,1KF,1KW 01.97 09.00 +  / + GUS-Staaten 1) 10.96 09.00 PR: 1KD,1KE,1KF,1KW 10.96 09.00 PR: 1KD,1KE,1KF,1KW 10.96 06.05 PR: 1KD,1KE,1KF,1KW 10.96 09.00 PR: 1KD,1KE,1KF,1KW 10.00 06.05 PR: 1KD,1KE,1KF,1KW 10.96 06.05 PR: 1KD,1KE,1KF,1KW 08.98 06.05 PR: 1KD,1KE,1KF,1KW 10.00 06.05 PR: 1KD,1KE,1KF,1KW 10.96 06.05 PR: 1KD,1KE,1KF,1KW 10.00 06.05 PR: 1KD,1KE,1KF,1KW 10.00 06.05 PR: 1KD,1KE,1KF,1KW 05.02 06.05 PR: 1KD,1KE,1KF,1KW 10.00 06.05 PR: 1KD,1KE,1KF,1KW 12.03 06.05 PR: 1KD,1KE,1KF,1KW 10.96 06.05 PR: 1KD,1KE,1KF,1KW 06.97 06.05 PR: 1KD,1KE,1KF,1KW 08.98 06.05 PR: 1KD,1KE,1KF,1KW 08.98 06.05 PR: 1KD,1KE,1KF,1KW 01.97 06.05 +  / + GUS-Staaten 1) 08.96 06.05 PR: 1KD,1KE,1KF,1KW 10.96 06.05 PR: 1KD,1KE,1KF,1KW 09.01 06.05 PR: 1KD,1KE,1KF,1KW	BA2017 BA2032			20961 17,2 /S 20961 15,2 /S	LUC LUC		
	1.6 85 1.8 92 1.8 1.8 T 1.9 TDI 66 1.9 TDI 74 1.9 TDI 81 1.9 TDI 85 1.9 TDI 96 2.0 85 2.0 96 2.0 TDI 100 2.3 2.3 4motion 2.5 TDI 2.5 TDI 4motion 2.8 132 2.8 142 2.8 4motion 4.0 W8 4motion	10.96 06.05 PR: 1KD,1KF 01.97 09.00 +  / + GUS-Staaten 1) 10.96 09.00 PR: 1KD,1KF 10.96 06.05 PR: 1KD,1KF 10.96 09.00 PR: 1KD,1KF 10.00 06.05 PR: 1KD,1KF 10.96 06.05 PR: 1KD,1KF 08.98 06.05 PR: 1KD,1KF 10.00 06.05 PR: 1KD,1KF 10.00 06.05 PR: 1KD,1KF 05.02 06.05 PR: 1KD,1KF 12.03 06.05 PR: 1KD,1KF 10.96 06.05 PR: 1KD,1KF 08.98 06.05 PR: 1KD,1KF 01.97 06.05 +  / + GUS-Staaten 1) 08.96 06.05 PR: 1KD,1KF	BAR10201			245 9,9 8,0			
	1.8 4motion 1.9 TDI 4motion 1.9 TDI 4motion 2.0 4motion 2.3 4motion 2.5 TDI 4motion 2.8 4motion 4.0 W8 4motion	10.00 06.05 PR: 1KD,1KF 10.00 06.05 PR: 1KD,1KF 10.00 06.05 PR: 1KD,1KF 10.00 06.05 PR: 1KD,1KF 10.00 06.05 PR: 1KD,1KF 10.00 06.05 PR: 1KD,1KF 10.00 06.05 PR: 1KD,1KF 09.01 06.05 PR: 1KD,1KF	BAR10224			245 10,0 8,0			
	1.4 TSI 1.6 1.6 FSI 1.6 TDI 1.8 TSI 1.8 TSI 1.9 TDI 2.0 FSI 2.0 FSI 4motion 2.0 TDI 2.0 TDI 2.0 TDI 2.0 TDI 2.0 TDI 120 2.0 TDI 125 2.0 TDI 16V 2.0 TDI 4motion 2.0 TDI 4motion 2.0 TFSI 2.0 TFSI 3.2 V6 FSI 3.2 V6 FSI 4motion 3.6 R36	10.07 07.10 PR: 1LJ,1LH,1ZG 03.05 07.10 PR: 1LJ,1LH,1ZG 03.05 07.10 PR: 1LJ,1LH,1ZG 08.09 07.10 PR: 1LJ,1LH,1ZG 11.09 07.10 PR: 1LJ,1LH,1ZG 10.07 07.10 PR: 1LJ,1LH,1ZG 03.05 07.10 PR: 1LJ,1LH,1ZG 03.05 07.10 PR: 1LJ,1LH,1ZG 03.05 07.10 PR: 1LJ,1LH,1ZG 03.05 07.10 PR: 1LJ,1LH,1ZG 03.05 07.10 PR: 1LJ,1LH,1ZG 08.05 07.10 PR: 1LJ,1LH,1ZG 08.05 07.10 PR: 1LJ,1LH,1ZG 03.05 07.10 PR: 1LJ,1LH,1ZG 03.05 07.10 PR: 1LJ,1LH,1ZG 05.09 07.10 PR: 1LJ,1LH,1ZG 03.05 07.10 PR: 1LJ,1LH,1ZG 11.05 07.10 PR: 1LJ,1LH,1ZG 09.05 07.10 PR: 1LJ,1LH,1ZG 04.07 07.10 PR: 1LJ,1LH,1ZG	BA2195			23587 19,6 +/-WK	ATE		
	1.4 TSI 1.6 1.6 FSI 1.6 TDI 1.8 TSI	10.07 07.10 PR: 1LJ,1LH,1ZG 03.05 07.10 PR: 1LJ,1LH,1ZG 03.05 07.10 PR: 1LJ,1LH,1ZG 08.09 07.10 PR: 1LJ,1LH,1ZG 11.09 07.10 PR: 1LJ,1LH,1ZG	BAR25158			312 25,0 22,0 V L			

1) / + GUS States / + / + Stati del GUS / + / + Etats de la CEI / + / + estados del GUS



















VOLKSWAGEN PASSAT Limousine (05-10)									
	1.8 TSI	118		10.07	07.10	PR: 1LJ,1LH,1ZG	BAR25158		312 25,0 22,0 V L
	1.9 TDI	77		03.05	07.10	PR: 1LJ,1LH,1ZG			
	2.0 FSI	110		03.05	07.10	PR: 1LJ,1LH,1ZG			
	2.0 FSI 4motion	110		03.05	07.10	PR: 1LJ,1LH,1ZG			
	2.0 TDI			03.05	07.10	PR: 1LJ,1LH,1ZG			
	2.0 TDI	120		03.05	07.10	PR: 1LJ,1LH,1ZG			
	2.0 TDI	125		08.05	07.10	PR: 1LJ,1LH,1ZG			
	2.0 TDI 16V	103		03.05	07.10	PR: 1LJ,1LH,1ZG			
	2.0 TDI 4motion	103		03.05	07.10	PR: 1LJ,1LH,1ZG			
	2.0 TDI 4motion	125		05.09	07.10	PR: 1LJ,1LH,1ZG			
	2.0 TFSI	147		03.05	07.10	PR: 1LJ,1LH,1ZG			
	3.2 V6 FSI	184		11.05	07.10	PR: 1LJ,1LH,1ZG			
	3.2 V6 FSI 4motion	184		09.05	07.10	PR: 1LJ,1LH,1ZG			
	3.6 R36	220		04.07	07.10	PR: 1LJ,1LH,1ZG			
	1.4 TSI			10.07	07.10	PR: 1KU	BA2196	elektrische Feststellbremse <sup>1)</sup>	23914 16,3 /WE/S LUC
	1.6	75		03.05	07.10	PR: 1KU			
	1.6 FSI	85		03.05	07.10	PR: 1KU			
	1.6 TDI	77		08.09	07.10	PR: 1KU			
	1.8 TSI	112		11.09	07.10	PR: 1KU			
	1.8 TSI	118		10.07	07.10	PR: 1KU			
	1.9 TDI	77		03.05	07.10	PR: 1KU			
	2.0 FSI	110		03.05	07.10	PR: 1KU			
	2.0 FSI 4motion	110		03.05	07.10	PR: 1KU			
	2.0 TDI			03.05	07.10	PR: 1KU			
	2.0 TDI	120		08.05	07.10	PR: 1KU			
	2.0 TDI	125		08.05	07.10	PR: 1KU			
	2.0 TDI 16V	103		03.05	07.10	PR: 1KU			
	2.0 TDI 4motion	103		03.05	07.10	PR: 1KU			
	2.0 TDI 4motion	125		05.09	07.10	PR: 1KU			
	2.0 TFSI	147		03.05	07.10	PR: 1KU			
	3.2 V6 FSI	184		11.05	07.10	PR: 1KU			
	3.2 V6 FSI 4motion	184		09.05	07.10	PR: 1KU			
	3.6 R36	220		04.07	07.10	PR: 1KU			
	1.4 TSI			10.07	07.10	PR: 2EA	BA2196	elektrische Feststellbremse <sup>1)</sup>	23914 16,3 /WE/S LUC
	1.6	75		03.05	07.10	PR: 2EA			
	1.6 FSI	85		03.05	07.10	PR: 2EA			
	1.6 TDI	77		08.09	07.10	PR: 2EA			
	1.8 TSI	112		11.09	07.10	PR: 2EA			
	1.8 TSI	118		10.07	07.10	PR: 2EA			
	1.9 TDI	77		03.05	07.10	PR: 2EA			
	2.0 FSI	110		03.05	07.10	PR: 2EA			
	2.0 FSI 4motion	110		03.05	07.10	PR: 2EA			
	2.0 TDI			03.05	07.10	PR: 2EA			
	2.0 TDI	120		08.05	07.10	PR: 2EA			
	2.0 TDI	125		08.05	07.10	PR: 2EA			
	2.0 TDI 16V	103		03.05	07.10	PR: 2EA			
	2.0 TDI 4motion	103		03.05	07.10	PR: 2EA			
	2.0 TDI 4motion	125		05.09	07.10	PR: 2EA			
	2.0 TFSI	147		03.05	07.10	PR: 2EA			
	3.2 V6 FSI	184		11.05	07.10	PR: 2EA			
	3.2 V6 FSI 4motion	184		09.05	07.10	PR: 2EA			
	3.6 R36	220		04.07	07.10	PR: 2EA			
	1.4 TSI			10.07	07.10	PR: 1KU	BAR12169	elektrische Feststellbremse <sup>1)</sup>	282 12,0 10,0
	1.6	75		03.05	07.10	PR: 1KU			
	1.6 FSI	85		03.05	07.10	PR: 1KU			
	1.6 TDI	77		08.09	07.10	PR: 1KU			
	1.8 TSI	112		11.09	07.10	PR: 1KU			
	1.8 TSI	118		10.07	07.10	PR: 1KU			
	1.9 TDI	77		03.05	07.10	PR: 1KU			
	2.0 FSI	110		03.05	07.10	PR: 1KU			
	2.0 FSI 4motion	110		03.05	07.10	PR: 1KU			
	2.0 TDI			03.05	07.10	PR: 1KU			
	2.0 TDI	120		08.05	07.10	PR: 1KU			
	2.0 TDI	125		08.05	07.10	PR: 1KU			
	2.0 TDI 16V	103		03.05	07.10	PR: 1KU			
	2.0 TDI 4motion	103		03.05	07.10	PR: 1KU			
	2.0 TDI 4motion	125		05.09	07.10	PR: 1KU			
	2.0 TFSI	147		03.05	07.10	PR: 1KU			
	3.2 V6 FSI	184		11.05	07.10	PR: 1KU			
	3.2 V6 FSI 4motion	184		09.05	07.10	PR: 1KU			
	3.6 R36	220		04.07	07.10	PR: 1KU			
VOLKSWAGEN PASSAT Variant (05-10)									
	1.4 TSI	90		10.07	07.10	PR: 1LJ,1LH,1ZG	BA2195		23587 19,6 +/WK ATE
	1.6	75		07.05	07.10	PR: 1LJ,1LH,1ZG			
	1.6 FSI	85		07.05	07.10	PR: 1LJ,1LH,1ZG			
	1.6 TDI	77		08.09	07.10	PR: 1LJ,1LH,1ZG			
	1.8 TSI	112		11.09	07.10	PR: 1LJ,1LH,1ZG			
	1.8 TSI	118		10.07	07.10	PR: 1LJ,1LH,1ZG			
	1.9 TDI	77		07.05	07.10	PR: 1LJ,1LH,1ZG			
	2.0 FSI	110		07.05	07.10	PR: 1LJ,1LH,1ZG			
	2.0 FSI 4motion	110		09.05	07.10	PR: 1LJ,1LH,1ZG			
	2.0 TDI			11.05	07.10	PR: 1LJ,1LH,1ZG			

<sup>1)</sup> electric parking brake / fr.di stazionamento elettrico / frein à main électrique / freno de mano eléctrico





















	   kW							
<b>VOLKSWAGEN PASSAT Variant (05-10)</b>								
	2.0 TDI 90 2.0 TDI 100 2.0 TDI 125 2.0 TDI 16V 103 2.0 TDI 4motion 103 2.0 TDI 4motion 125 2.0 TFSI 147 3.2 V6 FSI 184 3.2 V6 FSI 4motion 184 3.6 R36 220		07.05 07.10 PR: 1LJ,1LH,1ZG 07.05 07.10 PR: 1LJ,1LH,1ZG 07.05 07.10 PR: 1LJ,1LH,1ZG 07.05 07.10 PR: 1LJ,1LH,1ZG 08.05 07.10 PR: 1LJ,1LH,1ZG 09.05 07.10 PR: 1LJ,1LH,1ZG 05.09 07.10 PR: 1LJ,1LH,1ZG 07.05 07.10 PR: 1LJ,1LH,1ZG 11.05 07.10 PR: 1LJ,1LH,1ZG 11.05 07.10 PR: 1LJ,1LH,1ZG 04.07 07.10 PR: 1LJ,1LH,1ZG		BA2195			23587 19,6 +WK ATE
	1.4 TSI 90 1.6 75 1.6 FSI 85 1.6 TDI 77 1.8 TSI 112 1.8 TSI 118 1.9 TDI 77 2.0 FSI 110 2.0 FSI 4motion 110 2.0 TDI 90 2.0 TDI 100 2.0 TDI 125 2.0 TDI 16V 103 2.0 TDI 4motion 103 2.0 TDI 4motion 125 2.0 TFSI 147 3.2 V6 FSI 184 3.2 V6 FSI 4motion 184 3.6 R36 220		10.07 07.10 PR: 1LJ,1LH,1ZG 07.05 07.10 PR: 1LJ,1LH,1ZG 07.05 07.10 PR: 1LJ,1LH,1ZG 08.09 07.10 PR: 1LJ,1LH,1ZG 11.09 07.10 PR: 1LJ,1LH,1ZG 10.07 07.10 PR: 1LJ,1LH,1ZG 07.05 07.10 PR: 1LJ,1LH,1ZG 07.05 07.10 PR: 1LJ,1LH,1ZG 09.05 07.10 PR: 1LJ,1LH,1ZG 11.05 07.10 PR: 1LJ,1LH,1ZG 07.05 07.10 PR: 1LJ,1LH,1ZG 07.05 07.10 PR: 1LJ,1LH,1ZG 07.05 07.10 PR: 1LJ,1LH,1ZG 07.05 07.10 PR: 1LJ,1LH,1ZG 08.05 07.10 PR: 1LJ,1LH,1ZG 09.05 07.10 PR: 1LJ,1LH,1ZG 05.09 07.10 PR: 1LJ,1LH,1ZG 07.05 07.10 PR: 1LJ,1LH,1ZG 11.05 07.10 PR: 1LJ,1LH,1ZG 11.05 07.10 PR: 1LJ,1LH,1ZG 04.07 07.10 PR: 1LJ,1LH,1ZG		BAR25158			312 25,0 22,0 V L
	1.4 TSI 90 1.6 75 1.6 FSI 85 1.6 TDI 77 1.8 TSI 112 1.8 TSI 118 1.9 TDI 77 2.0 FSI 110 2.0 FSI 4motion 110 2.0 TDI 90 2.0 TDI 100 2.0 TDI 125 2.0 TDI 16V 103 2.0 TDI 4motion 103 2.0 TDI 4motion 125 2.0 TFSI 147 3.2 V6 FSI 184 3.2 V6 FSI 4motion 184 3.6 R36 220		10.07 07.10 PR: 1KU 07.05 07.10 PR: 1KU 07.05 07.10 PR: 1KU 08.09 07.10 PR: 1KU 11.09 07.10 PR: 1KU 10.07 07.10 PR: 1KU 07.05 07.10 PR: 1KU 07.05 07.10 PR: 1KU 09.05 07.10 PR: 1KU 11.05 07.10 PR: 1KU 07.05 07.10 PR: 1KU 07.05 07.10 PR: 1KU 07.05 07.10 PR: 1KU 08.05 07.10 PR: 1KU 09.05 07.10 PR: 1KU 05.09 07.10 PR: 1KU 07.05 07.10 PR: 1KU 11.05 07.10 PR: 1KU 11.05 07.10 PR: 1KU 04.07 07.10 PR: 1KU		BA2196		elektrische Feststellbremse <sup>1)</sup>	23914 16,3 /WE/S LUC
	1.4 TSI 90 1.6 75 1.6 FSI 85 1.6 TDI 77 1.8 TSI 112 1.8 TSI 118 1.9 TDI 77 2.0 FSI 110 2.0 FSI 4motion 110 2.0 TDI 90 2.0 TDI 100 2.0 TDI 125 2.0 TDI 16V 103 2.0 TDI 4motion 103 2.0 TDI 4motion 125 2.0 TFSI 147 3.2 V6 FSI 184 3.2 V6 FSI 4motion 184 3.6 R36 220		10.07 07.10 PR: 2EA 07.05 07.10 PR: 2EA 07.05 07.10 PR: 2EA 08.09 07.10 PR: 2EA 11.09 07.10 PR: 2EA 10.07 07.10 PR: 2EA 07.05 07.10 PR: 2EA 07.05 07.10 PR: 2EA 09.05 07.10 PR: 2EA 11.05 07.10 PR: 2EA 07.05 07.10 PR: 2EA 07.05 07.10 PR: 2EA 07.05 07.10 PR: 2EA 07.05 07.10 PR: 2EA 08.05 07.10 PR: 2EA 09.05 07.10 PR: 2EA 05.09 07.10 PR: 2EA 07.05 07.10 PR: 2EA 11.05 07.10 PR: 2EA 11.05 07.10 PR: 2EA 04.07 07.10 PR: 2EA		BA2196		elektrische Feststellbremse <sup>1)</sup>	23914 16,3 /WE/S LUC
	1.4 TSI 90 1.6 75 1.6 FSI 85 1.6 TDI 77 1.8 TSI 112 1.8 TSI 118 1.9 TDI 77 2.0 FSI 110 2.0 FSI 4motion 110 2.0 TDI 90 2.0 TDI 100 2.0 TDI 125 2.0 TDI 16V 103 2.0 TDI 4motion 103 2.0 TDI 4motion 125 2.0 TFSI 147 3.2 V6 FSI 184 3.2 V6 FSI 4motion 184 3.6 R36 220		10.07 07.10 PR: 1KU 07.05 07.10 PR: 1KU 07.05 07.10 PR: 1KU 08.09 07.10 PR: 1KU 11.09 07.10 PR: 1KU 10.07 07.10 PR: 1KU 07.05 07.10 PR: 1KU 07.05 07.10 PR: 1KU 09.05 07.10 PR: 1KU 11.05 07.10 PR: 1KU 07.05 07.10 PR: 1KU 07.05 07.10 PR: 1KU 07.05 07.10 PR: 1KU 07.05 07.10 PR: 1KU 08.05 07.10 PR: 1KU 09.05 07.10 PR: 1KU 05.09 07.10 PR: 1KU 07.05 07.10 PR: 1KU 11.05 07.10 PR: 1KU 11.05 07.10 PR: 1KU 04.07 07.10 PR: 1KU		BAR12169		elektrische Feststellbremse <sup>1)</sup>	282 12,0 10,0
								

<sup>1)</sup> electric parking brake / fr.di stazionamento elettrico / frein à main électrique / freno de mano eléctrico









	   kW							
<b>VOLKSWAGEN PASSAT Variant (05-10)</b>								
	2.0 TDI 125 2.0 TDI 16V 103 2.0 TDI 4motion 103 2.0 TDI 4motion 125 2.0 TFSI 147 3.2 V6 FSI 184 3.2 V6 FSI 4motion 184 3.6 R36 220		07.05 08.05 09.05 05.09 07.05 11.05 11.05 04.07	07.10 07.10 07.10 07.10 07.10 07.10 07.10 07.10	PR: 1KU PR: 1KU PR: 1KU PR: 1KU PR: 1KU PR: 1KU PR: 1KU PR: 1KU	BAR12169		elektrische Feststellbremse <sup>1)</sup> 282 12,0 10,0
<b>VOLKSWAGEN PASSAT CC (08-11)</b>								
	1.4 TSI MultiFuel 118 1.8 TSI 2.0 TDI 2.0 TDI 125 2.0 TDI 4motion 103 2.0 TDI 4motion 125 2.0 TSI 3.6 V6 4motion 220		01.11 04.08 04.08 06.08 08.09 11.09 04.08 04.08	09.11 09.11 09.11 09.11 09.11 09.11 09.11 09.11	PR: 1LH,1ZM,1ZG PR: 1LH,1ZM,1ZG PR: 1LH,1ZM,1ZG PR: 1LH,1ZM,1ZG PR: 1LH,1ZM,1ZG PR: 1LH,1ZM,1ZG PR: 1LH,1ZM,1ZG PR: 1LH,1ZM,1ZG	BA2195		23587 19,6 +/WK ATE
	1.4 TSI MultiFuel 118 1.8 TSI 2.0 TDI 2.0 TDI 125 2.0 TDI 4motion 103 2.0 TDI 4motion 125 2.0 TSI 3.6 V6 4motion 220		01.11 04.08 04.08 06.08 08.09 11.09 04.08 04.08	09.11 09.11 09.11 09.11 09.11 09.11 09.11 09.11	PR: 1LH,1ZM,1ZG PR: 1LH,1ZM,1ZG PR: 1LH,1ZM,1ZG PR: 1LH,1ZM,1ZG PR: 1LH,1ZM,1ZG PR: 1LH,1ZM,1ZG PR: 1LH,1ZM,1ZG PR: 1LH,1ZM,1ZG	BAR25158		312 25,0 22,0 V L
	1.4 TSI MultiFuel 118 1.8 TSI 2.0 TDI 2.0 TDI 125 2.0 TDI 4motion 125 2.0 TDI 4motion 125 2.0 TSI 3.6 V6 4motion 220		01.11 04.08 04.08 06.08 11.09 11.09 04.08 04.08	09.11 09.11 09.11 09.11 09.11 09.11 09.11 09.11	PR: 1KU,1KW,2EA PR: 1KU,1KW,2EA PR: 1KU,1KW,2EA PR: 1KU,1KW,2EA PR: 1KU,1KW,2EA PR: 1KU,1KW,2EA PR: 1KU,1KW,2EA PR: 1KU,1KW,2EA	BA2196		elektrische Feststellbremse <sup>1)</sup> 23914 16,3 /WE/S LUC
	1.4 TSI MultiFuel 118 1.8 TSI 2.0 TDI 2.0 TDI 125 2.0 TSI 3.6 V6 4motion 220		01.11 04.08 04.08 06.08 04.08 04.08	09.11 09.11 09.11 09.11 09.11 09.11	PR: 1KU PR: 1KU PR: 1KU PR: 1KU PR: 1KU PR: 1KU	BAR12169		elektrische Feststellbremse <sup>1)</sup> 282 12,0 10,0
	1.4 TSI MultiFuel 118 1.8 TSI 2.0 TDI 2.0 TDI 125 2.0 TDI 4motion 103 2.0 TDI 4motion 125 2.0 TSI 3.6 V6 4motion 220		01.11 04.08 04.08 06.08 08.09 11.09 04.08 04.08	09.11 09.11 09.11 09.11 09.11 09.11 09.11 09.11	PR: 1KW PR: 1KW PR: 1KW PR: 1KW PR: 1KW PR: 1KW PR: 1KW PR: 1KW	BAR12169		elektrische Feststellbremse <sup>1)</sup> 282 12,0 10,0
<b>VOLKSWAGEN PASSAT / PASSAT VARIANT (10-)</b>								
	1.4 TSI 90 1.4 TSI 110 1.6 TDI 77 1.8 TSI 118 2.0 TDI 2.0 TDI 125 2.0 TDI 4motion 103 2.0 TDI 4motion 125 2.0 TSI 155 2.0 TSI 4motion 155 3.6 FSI 4motion 220		08.10 08.10 08.10 08.10 08.10 08.10 08.10 08.10 11.10 01.12 01.11		PR: 1ZM,1ZG PR: 1ZM,1ZG PR: 1ZM,1ZG PR: 1ZM,1ZG PR: 1ZM,1ZG PR: 1ZM,1ZG PR: 1ZM,1ZG PR: 1ZM,1ZG PR: 1ZM,1ZG PR: 1ZM,1ZG PR: 1ZM,1ZG	BA2195		23587 19,6 +/WK ATE
	1.4 TSI 90 1.4 TSI 110 1.6 TDI 77 1.8 TSI 118 2.0 TDI 2.0 TDI 125 2.0 TDI 4motion 103 2.0 TDI 4motion 125 2.0 TSI 155 2.0 TSI 4motion 155 3.6 FSI 4motion 220		08.10 08.10 08.10 08.10 08.10 08.10 08.10 08.10 11.10 01.12 01.11		PR: 1ZM,1ZG PR: 1ZM,1ZG PR: 1ZM,1ZG PR: 1ZM,1ZG PR: 1ZM,1ZG PR: 1ZM,1ZG PR: 1ZM,1ZG PR: 1ZM,1ZG PR: 1ZM,1ZG PR: 1ZM,1ZG PR: 1ZM,1ZG	BAR25158		312 25,0 22,0 V L
	1.4 TSI 90 1.4 TSI 110 1.6 TDI 77 1.8 TSI 118 2.0 TDI 2.0 TDI 125 2.0 TDI 4motion 103 2.0 TDI 4motion 125 2.0 TSI 155 2.0 TSI 4motion 155 3.6 FSI 4motion 220		08.10 08.10 08.10 08.10 08.10 08.10 08.10 08.10 11.10 01.12 01.11		PR: 2EA PR: 2EA PR: 2EA PR: 2EA PR: 2EA PR: 2EA PR: 2EA PR: 2EA PR: 2EA PR: 2EA PR: 2EA	BA2196		elektrische Feststellbremse <sup>1)</sup> 23914 16,3 /WE/S LUC

<sup>1)</sup> electric parking brake / fr.di stazionamento elettrico / frein à main électrique / freno de mano eléctrico

									
<b>VOLKSWAGEN PASSAT / PASSAT VARIANT (10-)</b>									
	1.4 TSI 90 1.4 TSI 110 1.6 TDI 77 1.8 TSI 118 2.0 TDI 2.0 TDI 125 2.0 TDI 4motion 103 2.0 TDI 4motion 125 2.0 TSI 155 2.0 TSI 4motion 155 3.6 FSI 4motion 220		08.10 08.10 08.10 08.10 08.10 08.10 08.10 08.10 11.10 01.12 01.11	PR: 1KW PR: 1KW PR: 1KW PR: 1KW PR: 1KW PR: 1KW PR: 1KW PR: 1KW PR: 1KW PR: 1KW	BAR12169		elektrische Feststellbremse <sup>1)</sup>	282 12,0 10,0	
<b>VOLKSWAGEN PASSAT ALLTRACK (12-)</b>									
	1.8 TSI 118 2.0 TDI 103 2.0 TDI 4motion 103 2.0 TDI 4motion 125 2.0 TSI 4motion 155 3.6 V6 4motion 221		06.12 06.12 06.12 06.12 06.12 06.12	PR: 12M,12G PR: 12M,12G PR: 12M,12G PR: 12M,12G PR: 12M,12G PR: 12M,12G	BA2195			23587 19,6 +/WK ATE	
	1.8 TSI 118 2.0 TDI 103 2.0 TDI 4motion 103 2.0 TDI 4motion 125 2.0 TSI 4motion 155 3.6 V6 4motion 221		06.12 06.12 06.12 06.12 06.12 06.12	PR: 12M,12G PR: 12M,12G PR: 12M,12G PR: 12M,12G PR: 12M,12G PR: 12M,12G	BAR25158			312 25,0 22,0 V L	
	1.8 TSI 118 2.0 TDI 103 2.0 TDI 4motion 103 2.0 TDI 4motion 125 2.0 TSI 4motion 155 3.6 V6 4motion 221		06.12 06.12 06.12 06.12 06.12 06.12	PR: 2EA PR: 2EA PR: 2EA PR: 2EA PR: 2EA PR: 2EA	BA2196			23914 16,3 /WE/S LUC	
	1.8 TSI 118 2.0 TDI 103 2.0 TDI 4motion 103 2.0 TDI 4motion 125 2.0 TSI 4motion 155 3.6 V6 4motion 221		06.12 06.12 06.12 06.12 06.12 06.12	PR: 1KW PR: 1KW PR: 1KW PR: 1KW PR: 1KW PR: 1KW	BAR12169			282 12,0 10,0	
<b>VOLKSWAGEN POLO II (81-94)</b>									
	1.0 1.3 1.3 D 1.4 D 1.3 G40		03.85 03.85 08.86 08.90 01.87	09.94 09.94 09.90 09.94 09.94	BA2141			20887 17,3 +/Zub VW	
	1.0 1.1 1.3 1.3 D 1.4 D 1.3 G40		10.81 10.81 10.81 08.86 08.90 01.87	09.94 07.83 09.94 09.90 09.94 09.94	BA2133 BAR10151			20887 15,3 +/Zub VW 239 9,9 8,0	
	1.0 1.1 1.3 1.3 D 1.3 G40 1.4 D		10.81 10.81 10.81 08.86 01.87 08.90	09.94 07.83 09.94 09.90 09.94 09.94	BAR20123 BAH0008	2		239 20,0 18,0 V L L=290	
	1.0 1.1 1.3 1.3 D 1.3 G40 1.4 D		10.81 10.81 10.81 08.86 01.87 08.90	09.94 07.83 09.94 09.90 09.94 09.94	BAH0015	2		L=180	
	1.0 1.1 1.3 1.0 1.3 1.3 D 1.3 G40 1.4 D	...F-127903 ...F-127904 ...F-127904	10.81 10.81 10.81 09.94 09.94 08.86 01.87 08.90	- Bremskraftregler <sup>2)</sup> - Bremskraftregler <sup>2)</sup> - Bremskraftregler <sup>2)</sup> - Bremskraftregler <sup>2)</sup> - Bremskraftregler <sup>2)</sup> - Bremskraftregler <sup>2)</sup> - Bremskraftregler <sup>2)</sup> - Bremskraftregler <sup>2)</sup>	BAW1401 BAW1501	+ GG <sup>3)</sup> + GG <sup>3)</sup>		Rz 14,29 Rz 15,87	
	1.0 1.1 1.3 1.0 1.3 1.3 D 1.3 G40 1.4 D	...F-127903 ...F-127903 ...F-127904 ...F-127904	10.81 10.81 10.81 09.94 09.94 08.86 01.87 08.90	+ Bremskraftregler <sup>4)</sup> + Bremskraftregler <sup>4)</sup> + Bremskraftregler <sup>4)</sup> + Bremskraftregler <sup>4)</sup> + Bremskraftregler <sup>4)</sup> + Bremskraftregler <sup>4)</sup> + Bremskraftregler <sup>4)</sup> + Bremskraftregler <sup>4)</sup>	BAW1701 BAW1905	+ GG <sup>3)</sup>		Rz 17,46 Rz 19,05	
	1.0 1.1 1.3 1.3 D 1.3 G40 1.4 D		10.81 10.81 10.81 08.86 01.87 08.90	09.94 07.83 09.94 09.90 09.94 09.94	BAE5003			180 x 31 HEB	









<sup>1)</sup> electric parking brake / fr.di stazionamento elettrico / frein à main électrique / freno de mano eléctrico  
<sup>2)</sup> - brake pressure regulator / - correttore di frenata / - correcteur de freinage / - corrector de frenado  
<sup>3)</sup> + cast iron / + ghisa / + fonte grise / + fundición de gris  
<sup>4)</sup> + brake pressure regulator / + correttore di frenata / + correcteur de freinage / + corrector de frenado

**VOLKSWAGEN POLO III (95-01)**

	1.05 1.3 1.4 1.4 1.6 1.9 D 1.9 SDI		6N-TY140000 <b>10.94</b> 6N-TY140000 <b>10.94</b> 6N-TY140000 <b>07.95</b> 6N-TY140000 <b>07.95</b> 6N-TY140000 <b>10.94</b> 6N-TY140000 <b>10.94</b> 6N-TY140000 <b>10.94</b>		BA2141		20887 17,3 +/-Zub	VW	
	1.0 1.05 1.3 1.4 1.4 1.4 16V 1.6 1.7 SDI 1.9 D 1.9 SDI		07.96 09.01 09.96 04.97 09.01 09.01 01.99 09.01 05.97 09.01		BA2152	- ABS	21866 17,3 +	VW	
	1.4 16V 1.4 16V 1.4 TDI 1.6 GTI	55 74 55	01.99 04.96 01.99 04.98	09.01 09.01 09.01 09.01	BA2018	+ ABS - Motorsport 1)	21945 16,3 /S	LUC	
	1.05 1.3 1.6 1.9 D 1.9 SDI		6N-SY087410 <b>10.94</b> 6N-SY087410 <b>10.94</b> 6N-SY087410 <b>10.94</b> 6N-SY087410 <b>10.94</b> 6N-SY087410 <b>10.94</b>		BAR10232		239 10,0 8,0 L		
	1.0 1.05 1.3 1.4 1.4 1.4 16V 1.6 1.7 SDI 1.9 D 1.9 SDI		07.96 09.01 09.96 04.97 07.95 09.01 07.95 09.01 01.99 09.01 05.97 09.01		BAR18106	- ABS	240 18,0 16,0 V L		
	1.4 16V 1.4 16V 1.4 TDI	55 74 55	01.99 04.96 01.99	09.01 09.01 09.01	BAR20128	+ ABS	256 20,0 18,0 V L		
	1.0 1.05 1.3 1.4 1.4 1.4 16V 1.4 16V 1.4 TDI 1.6 1.6 GTI 1.7 SDI 1.9 D 1.9 SDI		07.96 10.94 10.94 07.95 07.95 01.99 04.96 01.99 10.94 04.98 05.97 10.94 10.94	09.01 09.96 04.97 09.01 09.01 09.01 09.01 09.01 09.99 09.01 09.01 09.01 09.01		BAH0019	2	L=380	
	1.4 16V 1.6 GTI	74 74	04.96 04.98	09.01 09.99	BAH0023	+ Motorsport 2)	L=435		
	1.4 16V 1.6 GTI 1.4 16V 1.4 16V 1.4 TDI 1.6 GTI	55 74 74 74 55	01.99 10.99 01.99 10.99	09.01 09.01 09.01 09.01	BA2017 BA2032	+ ABS + ABS + ABS + ABS	20961 17,2 /S 20961 15,2 /S	LUC LUC	
	1.4 16V 1.6 GTI 1.4 16V 1.4 16V 1.4 TDI 1.6 GTI	74 55 74 74 55	04.96 04.98 01.99 10.99 01.99 10.99	09.99 09.99 09.01 09.01 09.01 09.01	BAR10111 BAR09124	+ ABS + ABS + ABS + ABS	ohne Sensorring 4) 226 10,0 8,0 232 8,9 7,0		
	1.0 1.05 1.3 1.4 1.4 1.4 16V 1.4 16V 1.4 TDI 1.6 1.7 SDI 1.9 D 1.9 SDI		07.96 10.94 10.94 07.95 07.95 01.99 04.96 01.99 10.94 05.97 10.94 10.94	09.99 09.96 04.97 09.99 09.99 09.99 09.99 09.99 09.99 09.99 09.99 09.99		BAH0003	2	am Bremssattel 5)	L=160
	1.0 1.4 1.4 1.4 16V 1.4 16V 1.4 TDI 1.7 SDI 1.9 D	40 44 55 74 55	10.99 10.99 10.99 10.99 10.99 10.99 10.99	09.01 09.01 09.01 09.01 09.01 09.01 09.01	BAH0033	- ABS - ABS - ABS - ABS	L=140		

1) - motorsports / - motorsports / - Motorsport / - motorismo  
 2) + motorsports / + motorsports / + Motorsport / + motorismo  
 3) + ⊕ / - motorsports / + ⊕ / - motorsports / + ⊕ / - Motorsport / + ⊕ / - motorismo  
 4) without sensor ring / senza sensori / sans secours ABS / sin anillo sensor ABS  
 5) on the brake caliper / sulla pinza freno / sur l'étrier de frein / a la pinza de freno

**VOLKSWAGEN POLO III (95-01)**



	1.9 SDI			<b>10.99</b>	<b>09.01</b>		<b>BAH0033</b>	2		L=140
	1.4 16V	55		<b>01.99</b>	<b>09.99</b>	+ ABS	<b>BAH0003</b>	2		L=160
	1.4 16V	74		<b>04.96</b>	<b>09.99</b>	+ 				
	1.4 TDI	55		<b>01.99</b>	<b>09.99</b>	+ ABS				
	1.6 GTI			<b>04.98</b>	<b>09.99</b>					
	1.0			<b>07.96</b>	<b>09.01</b>		<b>BAW1701</b>		+ GG <sup>1)</sup>	Rz 17,46
	1.05			<b>10.94</b>	<b>09.96</b>					
	1.3			<b>10.94</b>	<b>04.97</b>					
	1.4	40		<b>07.95</b>	<b>09.01</b>					
	1.4	44		<b>07.95</b>	<b>09.01</b>					
	1.4 16V	55		<b>01.99</b>	<b>09.01</b>	+ ABS				
	1.4 16V	74		<b>04.96</b>	<b>09.01</b>	- 				
	1.4 TDI	55		<b>01.99</b>	<b>09.01</b>	+ ABS				
	1.6	55		<b>10.94</b>	<b>09.99</b>					
	1.7 SDI			<b>05.97</b>	<b>09.01</b>					
	1.9 D			<b>10.94</b>	<b>09.01</b>					
	1.9 SDI			<b>10.94</b>	<b>09.01</b>					
	1.4 16V	55		<b>01.99</b>	<b>09.01</b>	- ABS	<b>BAW1905</b>			Rz 19,05
	1.4 TDI	55		<b>01.99</b>	<b>09.01</b>	- ABS				
	1.0			6N-XY227489 <b>07.96</b>		- ABS	<b>BAE5003</b>			180 x 31 HEB
	1.05			6N-XY227489 <b>10.94</b>		- ABS				
	1.3			6N-XY227489 <b>10.94</b>		- ABS				
	1.4	40		6N-XY227489 <b>07.95</b>		- ABS				
	1.4	44		6N-XY227489 <b>07.95</b>		- ABS				
	1.4 16V	74		6N-XY227489 <b>04.96</b>		- ABS/ - 				
	1.6	55		6N-XY227489 <b>10.94</b>		- ABS				
	1.7 SDI			6N-XY227489 <b>05.97</b>		- ABS				
	1.9 D			6N-XY227489 <b>10.94</b>		- ABS				
	1.9 SDI			6N-XY227489 <b>10.94</b>		- ABS				
	1.0			6N-XY227489 <b>07.96</b>		+ ABS	<b>BAE5001</b>			200 x 40 HEB <b>VW</b>
	1.0	6N-XY227490			<b>09.01</b>	+ ABS				
	1.05			6N-XY227489 <b>10.94</b>		+ ABS				
	1.05	6N-XY227490			<b>09.01</b>	+ ABS				
	1.3			6N-XY227489 <b>10.94</b>		+ ABS				
	1.3	6N-XY227490			<b>09.01</b>	+ ABS				
	1.4	40		6N-XY227489 <b>07.95</b>		+ ABS				
	1.4	40	6N-XY227490		<b>09.01</b>	+ ABS				
	1.4	44		6N-XY227489 <b>07.95</b>		+ ABS				
	1.4	44	6N-XY227490		<b>09.01</b>	+ ABS				
	1.4 16V	55			<b>01.99</b>	- ABS				
	1.4 16V	74		6N-XY227489 <b>04.96</b>		+ ABS/ - 				
	1.4 16V	74	6N-XY227490		<b>09.01</b>	- 				
	1.4 TDI	55			<b>01.99</b>	- ABS				
	1.6	55		6N-XY227489 <b>10.94</b>		+ ABS				
	1.6	55	6N-XY227490		<b>09.99</b>	+ ABS				
	1.7 SDI			6N-XY227489 <b>05.97</b>		+ ABS				
	1.7 SDI		6N-XY227490		<b>09.01</b>	+ ABS				
	1.9 D			6N-XY227489 <b>10.94</b>		+ ABS				
	1.9 D		6N-XY227490		<b>09.01</b>	+ ABS				
	1.9 SDI			6N-XY227489 <b>10.94</b>		+ ABS				
	1.9 SDI		6N-XY227490		<b>09.01</b>	+ ABS				

















**VOLKSWAGEN POLO IV (02-09)**

















	1.2			<b>11.01</b>	<b>05.09</b>	PR: 1LM,1ZN	<b>BA2152</b>			21866 17,3 + <b>VW</b>
	1.2	44		<b>04.07</b>	<b>05.09</b>	PR: 1LM,1ZN				
	1.2	51		<b>04.07</b>	<b>05.09</b>	PR: 1LM,1ZN				
	1.4 16V			<b>05.06</b>	<b>05.09</b>	PR: 1LM,1ZN				
	1.4 16V	55		<b>11.01</b>	<b>05.09</b>	PR: 1LM,1ZN				
	1.4 16V	74		<b>11.01</b>	<b>05.09</b>	PR: 1LM,1ZN				
	1.4 FSI			<b>11.01</b>	<b>05.09</b>	PR: 1LM,1ZN				
	1.4 TDI			<b>11.01</b>	<b>05.09</b>	PR: 1LM,1ZN				
	1.6 16V	77		<b>05.06</b>	<b>05.09</b>	PR: 1LM,1ZN				
	1.8 GTI	110		<b>09.05</b>	<b>05.09</b>	PR: 1LM,1ZN				
	1.8 GTI	132		<b>06.06</b>	<b>05.09</b>	PR: 1LM,1ZN				
	1.9 SDI			<b>11.01</b>	<b>05.09</b>	PR: 1LM,1ZN				
	1.9 TDI	74		<b>11.01</b>	<b>05.09</b>	PR: 1LM,1ZN				
	1.9 TDI	96		<b>10.03</b>	<b>05.09</b>	PR: 1LM,1ZN				
	2.0	85		<b>04.02</b>	<b>05.09</b>	PR: 1LM,1ZN				
	1.2			<b>11.01</b>	<b>05.09</b>	PR: 1LQ,1LR,1ZG	<b>BA2155</b>			23131 19,6 +/WK <b>VW</b>
	1.2	44		<b>04.07</b>	<b>05.09</b>	PR: 1LQ,1LR,1ZG				
	1.2	51		<b>04.07</b>	<b>05.09</b>	PR: 1LQ,1LR,1ZG				
	1.4 16V			<b>05.06</b>	<b>05.09</b>	PR: 1LQ,1LR,1ZG				
	1.4 16V	55		<b>11.01</b>	<b>05.09</b>	PR: 1LQ,1LR,1ZG				
	1.4 16V	74		<b>11.01</b>	<b>05.09</b>	PR: 1LQ,1LR,1ZG				
	1.4 FSI			<b>11.01</b>	<b>05.09</b>	PR: 1LQ,1LR,1ZG				
	1.4 TDI			<b>11.01</b>	<b>05.09</b>	PR: 1LQ,1LR,1ZG				
	1.6 16V	77		<b>05.06</b>	<b>05.09</b>	PR: 1LQ,1LR,1ZG				
	1.8 GTI	110		<b>09.05</b>	<b>05.09</b>	PR: 1LQ,1LR,1ZG				
	1.8 GTI	132		<b>06.06</b>	<b>05.09</b>	PR: 1LQ,1LR,1ZG				
	1.9 SDI			<b>11.01</b>	<b>05.09</b>	PR: 1LQ,1LR,1ZG				
	1.9 TDI	74		<b>11.01</b>	<b>05.09</b>	PR: 1LQ,1LR,1ZG				
	1.9 TDI	96		<b>10.03</b>	<b>05.09</b>	PR: 1LQ,1LR,1ZG				
	2.0	85		<b>04.02</b>	<b>05.09</b>	PR: 1LQ,1LR,1ZG				
	1.2			<b>11.01</b>	<b>05.09</b>	PR: 1ZF	<b>BA2154</b>			23130 19,6 + <b>VW</b>
	1.2	44		<b>04.07</b>	<b>05.09</b>	PR: 1ZF				
	1.2	51		<b>04.07</b>	<b>05.09</b>	PR: 1ZF				



















<sup>1)</sup> + cast iron / + ghisa / + fonte grise / + fundición de gris

**VOLKSWAGEN POLO IV (02-09)**

	1.4 16V 1.4 16V 1.4 16V 1.4 FSI 1.4 TDI 1.6 16V 1.8 GTI 1.8 GTI 1.9 SDI 1.9 TDI 1.9 TDI 2.0	55 74 77 110 132 74 96 85	05.06 11.01 11.01 11.01 11.01 05.06 09.05 06.06 11.01 11.01 10.03 04.02	05.09 PR: 1ZF 05.09 PR: 1ZF 05.09 PR: 1ZF 05.09 PR: 1ZF 05.09 PR: 1ZF 05.09 PR: 1ZF 05.09 PR: 1ZF 05.09 PR: 1ZF 05.09 PR: 1ZF 05.09 PR: 1ZF 05.09 PR: 1ZF 05.09 PR: 1ZF	BA2154	23130 19,6 +	VW
	1.2 1.2 1.2 1.4 16V 1.4 16V 1.4 16V 1.4 FSI 1.4 TDI 1.6 16V 1.8 GTI 1.8 GTI 1.9 SDI 1.9 TDI 1.9 TDI 2.0	44 51 55 74 77 110 132 74 96 85	11.01 04.07 04.07 05.06 11.01 11.01 11.01 11.01 05.06 09.05 06.06 11.01 11.01 10.03 04.02	05.09 PR: 1LN,1ZD,1ZH 05.09 PR: 1LN,1ZD,1ZH 05.09 PR: 1LN,1ZD,1ZH 05.09 PR: 1LN,1ZD,1ZH 05.09 PR: 1LN,1ZD,1ZH 05.09 PR: 1LN,1ZD,1ZH 05.09 PR: 1LN,1ZD,1ZH 05.09 PR: 1LN,1ZD,1ZH 05.09 PR: 1LN,1ZD,1ZH 05.09 PR: 1LN,1ZD,1ZH 05.09 PR: 1LN,1ZD,1ZH 05.09 PR: 1LN,1ZD,1ZH 05.09 PR: 1LN,1ZD,1ZH 05.09 PR: 1LN,1ZD,1ZH 05.09 PR: 1LN,1ZD,1ZH	BA2298	23843 18,8 +/WK/S	LUC
	1.2 1.2 1.2 1.4 16V 1.4 16V 1.4 16V 1.4 FSI 1.4 TDI 1.6 16V 1.8 GTI 1.8 GTI 1.9 SDI 1.9 TDI 1.9 TDI 2.0	44 51 55 74 77 110 132 74 96 85	11.01 04.07 04.07 05.06 11.01 11.01 11.01 11.01 05.06 09.05 06.06 11.01 11.01 10.03 04.02	05.09 PR: 1LJ 05.09 PR: 1LJ 05.09 PR: 1LJ 05.09 PR: 1LJ 05.09 PR: 1LJ 05.09 PR: 1LJ 05.09 PR: 1LJ 05.09 PR: 1LJ 05.09 PR: 1LJ 05.09 PR: 1LJ 05.09 PR: 1LJ 05.09 PR: 1LJ 05.09 PR: 1LJ 05.09 PR: 1LJ 05.09 PR: 1LJ	BA2205	23392 20,6 +/WK	ATE
	1.2 1.2 1.2 1.4 16V 1.4 16V 1.4 16V 1.4 FSI 1.4 TDI 1.6 16V 1.8 GTI 1.8 GTI 1.9 SDI 1.9 TDI 1.9 TDI 2.0	44 51 55 74 77 110 132 74 96 85	11.01 04.07 04.07 05.06 11.01 11.01 11.01 11.01 05.06 09.05 06.06 11.01 11.01 10.03 04.02	05.09 PR: 1LM,1ZN 05.09 PR: 1LM,1ZN 05.09 PR: 1LM,1ZN 05.09 PR: 1LM,1ZN 05.09 PR: 1LM,1ZN 05.09 PR: 1LM,1ZN 05.09 PR: 1LM,1ZN 05.09 PR: 1LM,1ZN 05.09 PR: 1LM,1ZN 05.09 PR: 1LM,1ZN 05.09 PR: 1LM,1ZN 05.09 PR: 1LM,1ZN 05.09 PR: 1LM,1ZN 05.09 PR: 1LM,1ZN	BAR18137	239 18,0 16,0 V L	
	1.2 1.2 1.2 1.4 16V 1.4 16V 1.4 16V 1.4 FSI 1.4 TDI 1.6 16V 1.8 GTI 1.8 GTI 1.9 SDI 1.9 TDI 1.9 TDI 2.0	44 51 55 74 77 110 132 74 96 85	11.01 04.07 04.07 05.06 11.01 11.01 11.01 11.01 05.06 09.05 06.06 11.01 11.01 10.03 04.02	05.09 PR: 1LQ,1LR,1ZF,1ZG 05.09 PR: 1LQ,1LR,1ZF,1ZG 05.09 PR: 1LQ,1LR,1ZF,1ZG 05.09 PR: 1LQ,1LR,1ZF,1ZG 05.09 PR: 1LQ,1LR,1ZF,1ZG 05.09 PR: 1LQ,1LR,1ZF,1ZG 05.09 PR: 1LQ,1LR,1ZF,1ZG 05.09 PR: 1LQ,1LR,1ZF,1ZG 05.09 PR: 1LQ,1LR,1ZF,1ZG 05.09 PR: 1LQ,1LR,1ZF,1ZG 05.09 PR: 1LQ,1LR,1ZF,1ZG 05.09 PR: 1LQ,1LR,1ZF,1ZG 05.09 PR: 1LQ,1LR,1ZF,1ZG 05.09 PR: 1LQ,1LR,1ZF,1ZG 05.09 PR: 1LQ,1LR,1ZF,1ZG	BAR22151	256 22,0 19,0 V L	
	1.2 1.2 1.2 1.4 16V 1.4 16V 1.4 16V 1.4 FSI 1.4 TDI 1.6 16V 1.8 GTI 1.8 GTI 1.9 SDI 1.9 TDI 1.9 TDI 2.0	44 51 55 74 77 110 132 74 96 85	11.01 04.07 04.07 05.06 11.01 11.01 11.01 11.01 05.06 09.05 06.06 11.01 11.01 10.03 04.02	05.09 PR: 1LN,1ZD,1ZH 05.09 PR: 1LN,1ZD,1ZH 05.09 PR: 1LN,1ZD,1ZH 05.09 PR: 1LN,1ZD,1ZH 05.09 PR: 1LN,1ZD,1ZH 05.09 PR: 1LN,1ZD,1ZH 05.09 PR: 1LN,1ZD,1ZH 05.09 PR: 1LN,1ZD,1ZH 05.09 PR: 1LN,1ZD,1ZH 05.09 PR: 1LN,1ZD,1ZH 05.09 PR: 1LN,1ZD,1ZH 05.09 PR: 1LN,1ZD,1ZH 05.09 PR: 1LN,1ZD,1ZH 05.09 PR: 1LN,1ZD,1ZH 05.09 PR: 1LN,1ZD,1ZH	BAR25113	288 25,0 22,0 V L	

	   kW							
<b>VOLKSWAGEN POLO IV (02-09)</b>								
	1.2 1.2 1.2 1.4 16V 1.4 16V 1.4 16V 1.4 FSI 1.4 TDI 1.6 16V 1.8 GTI 1.8 GTI 1.9 SDI 1.9 TDI 1.9 TDI 2.0	44 51 55 74 77 110 132 74 96 85		11.01 05.09 PR: 1LJ 04.07 05.09 PR: 1LJ 04.07 05.09 PR: 1LJ 05.06 05.09 PR: 1LJ 11.01 05.09 PR: 1LJ 11.01 05.09 PR: 1LJ 11.01 05.09 PR: 1LJ 11.01 05.09 PR: 1LJ 05.06 05.09 PR: 1LJ 09.05 05.09 PR: 1LJ 06.06 05.09 PR: 1LJ 11.01 05.09 PR: 1LJ 11.01 05.09 PR: 1LJ 10.03 05.09 PR: 1LJ 04.02 05.09 PR: 1LJ	BAR25123			312 25,0 23,0 VL
	1.4 16V 1.4 16V 1.4 16V 1.4 FSI 1.4 TDI 1.6 16V 1.8 GTI 1.8 GTI 1.9 TDI 1.9 TDI 2.0	55 74 77 110 132 74 96 85		05.06 05.09 PR: 1KD,1KS,1KV 11.01 05.09 PR: 1KD,1KS,1KV 11.01 05.09 PR: 1KD,1KS,1KV 11.01 05.09 PR: 1KD,1KS,1KV 11.01 05.09 PR: 1KD,1KS,1KV 05.06 05.09 PR: 1KD,1KS,1KV 09.05 05.09 PR: 1KD,1KS,1KV 06.06 05.09 PR: 1KD,1KS,1KV 11.01 05.09 PR: 1KD,1KS,1KV 10.03 05.09 PR: 1KD,1KS,1KV 04.02 05.09 PR: 1KD,1KS,1KV	BA2017 BA2032			20961 17,2 /S 20961 15,2 /S LUC LUC
	1.4 16V 1.4 16V 1.4 16V 1.4 FSI 1.4 TDI 1.6 16V 1.8 GTI 1.8 GTI 1.9 TDI 1.9 TDI 2.0	55 74 77 110 132 74 96 85		05.06 05.09 PR: 1KD,1KS,1KV 11.01 05.09 PR: 1KD,1KS,1KV 11.01 05.09 PR: 1KD,1KS,1KV 11.01 05.09 PR: 1KD,1KS,1KV 11.01 05.09 PR: 1KD,1KS,1KV 05.06 05.09 PR: 1KD,1KS,1KV 09.05 05.09 PR: 1KD,1KS,1KV 06.06 05.09 PR: 1KD,1KS,1KV 11.01 05.09 PR: 1KD,1KS,1KV 10.03 05.09 PR: 1KD,1KS,1KV 04.02 05.09 PR: 1KD,1KS,1KV	BAR09123			232 8,9 7,0
	1.2 1.2 1.2 1.4 16V 1.4 16V 1.4 16V 1.4 FSI 1.4 TDI 1.6 16V 1.8 GTI 1.8 GTI 1.9 SDI 1.9 TDI 1.9 TDI 2.0	44 51 55 74 77 110 132 74 96 85		11.01 05.09 04.07 05.09 04.07 05.09 05.06 05.09 11.01 05.09 11.01 05.09 11.01 05.09 11.01 05.09 05.06 05.09 09.05 05.09 06.06 05.09 11.01 05.09 11.01 05.09 10.03 05.09 04.02 05.09	BAH0033	2		L=140
	1.2 1.2 1.2 1.4 16V 1.4 FSI 1.4 TDI 1.9 SDI	44 51 55		11.01 05.09 PR: 1KB 04.07 05.09 PR: 1KB 04.07 05.09 PR: 1KB 11.01 05.09 PR: 1KB 11.01 05.09 PR: 1KB 11.01 05.09 PR: 1KB 11.01 05.09 PR: 1KB	BAW1701			Rz 17,46
	1.2 1.2 1.2 1.4 16V 1.4 FSI 1.4 TDI 1.9 SDI	44 51 55		11.01 05.09 PR: 1KB 04.07 05.09 PR: 1KB 04.07 05.09 PR: 1KB 11.01 05.09 PR: 1KB 11.01 05.09 PR: 1KB 11.01 05.09 PR: 1KB 11.01 05.09 PR: 1KB	BAE5001			200 x 40 HEB VW
<b>VOLKSWAGEN POLO V (09-)</b>								
	1.2 1.2 1.2 TDI 1.2 TSI 1.2 TSI 1.4 1.4 GTI 1.6 BiFuel 1.6 TDI 1.6 TDI	44 51 55 66 77 63 132 60 55		03.09 PR: 1ZG,1LR,1ZJ 03.09 PR: 1ZG,1LR,1ZJ 10.09 PR: 1ZG,1LR,1ZJ 05.11 PR: 1ZG,1LR,1ZJ 06.09 PR: 1ZG,1LR,1ZJ 03.09 PR: 1ZG,1LR,1ZJ 05.10 PR: 1ZG,1LR,1ZJ 01.11 PR: 1ZG,1LR,1ZJ 06.09 PR: 1ZG,1LR,1ZJ 03.09 PR: 1ZG,1LR,1ZJ	BA2154			23130 19,6 + VW
	1.2 1.2 1.2 TDI 1.2 TSI 1.2 TSI 1.4 1.4 GTI 1.6 BiFuel 1.6 TDI	44 51 55 66 77 63 132 60		03.09 PR: 1LN,1ZC,1ZD 03.09 PR: 1LN,1ZC,1ZD 10.09 PR: 1LN,1ZC,1ZD 05.11 PR: 1LN,1ZC,1ZD 06.09 PR: 1LN,1ZC,1ZD 03.09 PR: 1LN,1ZC,1ZD 05.10 PR: 1LN,1ZC,1ZD 01.11 PR: 1LN,1ZC,1ZD 06.09 PR: 1LN,1ZC,1ZD	BA2195			23587 19,6 +/WK ATE

											
<b>VOLKSWAGEN POLO V (09-)</b>											
	1.6 TDI	55		03.09	PR: 1LN,1ZC,1ZD		BA2195	23587 19,6 +WK ATE			
	1.2	44		03.09	PR: 1LR,1ZG,1ZJ		BAR22151	256 22,0 19,0 V L			
	1.2	51		03.09	PR: 1LR,1ZG,1ZJ						
	1.2 TDI	55		10.09	PR: 1LR,1ZG,1ZJ						
	1.2 TSI	66		05.11	PR: 1LR,1ZG,1ZJ						
	1.2 TSI	77		06.09	PR: 1LR,1ZG,1ZJ						
	1.4	63		03.09	PR: 1LR,1ZG,1ZJ						
	1.4 GTI	132		05.10	PR: 1LR,1ZG,1ZJ						
	1.6 BiFuel	60		01.11	PR: 1LR,1ZG,1ZJ						
	1.6 TDI			06.09	PR: 1LR,1ZG,1ZJ						
	1.6 TDI	55		03.09	PR: 1LR,1ZG,1ZJ						
	1.2	44		03.09	PR: 1ZC, 1ZD				BAR25113	288 25,0 22,0 V L	
	1.2	51		03.09	PR: 1ZC, 1ZD						
	1.2 TDI	55		10.09	PR: 1ZC, 1ZD						
	1.2 TSI	66		05.11	PR: 1ZC, 1ZD						
1.2 TSI	77		06.09	PR: 1ZC, 1ZD							
1.4	63		03.09	PR: 1ZC, 1ZD							
1.4 GTI	132		05.10	PR: 1ZC, 1ZD							
1.6 BiFuel	60		01.11	PR: 1ZC, 1ZD							
1.6 TDI			06.09	PR: 1ZC, 1ZD							
1.6 TDI	55		03.09	PR: 1ZC, 1ZD							
	1.2	44		03.09	PR: 1KK,1KT,1KV		BA2017	20961 17,2 /S LUC			
	1.2	51		03.09	PR: 1KK,1KT,1KV						
	1.2 TDI	55		10.09	PR: 1KK,1KT,1KV						
	1.2 TSI	66		05.11	PR: 1KK,1KT,1KV						
	1.2 TSI	77		06.09	PR: 1KK,1KT,1KV						
	1.4	63		03.09	PR: 1KK,1KT,1KV						
	1.4 GTI	132		05.10	PR: 1KK,1KT,1KV						
	1.6 BiFuel	60		01.11	PR: 1KK,1KT,1KV						
	1.6 TDI			06.09	PR: 1KK,1KT,1KV						
	1.6 TDI	55		03.09	PR: 1KK,1KT,1KV						
	1.2	44		03.09	PR: 2EJ				BA2017	20961 17,2 /S LUC	
	1.2	51		03.09	PR: 2EJ						
	1.2 TDI	55		10.09	PR: 2EJ						
	1.2 TSI	66		05.11	PR: 2EJ						
1.2 TSI	77		06.09	PR: 2EJ							
1.4	63		03.09	PR: 2EJ							
1.4 GTI	132		05.10	PR: 2EJ							
1.6 BiFuel	60		01.11	PR: 2EJ							
1.6 TDI			06.09	PR: 2EJ							
1.6 TDI	55		03.09	PR: 2EJ							
	1.2	44		03.09			BAH0033	L=140			
	1.2	51		03.09							
	1.2 TDI	55		10.09							
	1.2 TSI	66		05.11							
	1.2 TSI	77		06.09							
	1.4	63		03.09							
	1.4 GTI	132		05.10							
	1.6 BiFuel	60		01.11							
	1.6 TDI			06.09							
	1.6 TDI	55		03.09							
		1.2	44		03.09	PR: 1KB				BAW1701	Rz 17,46
		1.2	51		03.09	PR: 1KB					
		1.2 TDI	55		10.09	PR: 1KB					
		1.2 TSI	66		05.11	PR: 1KB					
1.2 TSI		77		06.09	PR: 1KB						
1.4		63		03.09	PR: 1KB						
1.6 BiFuel		60		01.11	PR: 1KB						
1.6 TDI				06.09	PR: 1KB						
1.6 TDI		55		03.09	PR: 1KB						
		1.2	44		03.09	PR: 1KB,1KM		BAE5001	200 x 40 HEB VW		
		1.2	51		03.09	PR: 1KB,1KM					
		1.2 TDI	55		10.09	PR: 1KB,1KM					
		1.2 TSI	66		05.11	PR: 1KB,1KM					
		1.2 TSI	77		06.09	PR: 1KB,1KM					
	1.4	63		03.09	PR: 1KB,1KM						
	1.6 BiFuel	60		01.11	PR: 1KB,1KM						
	1.6 TDI			06.09	PR: 1KB,1KM						
	1.6 TDI	55		03.09	PR: 1KB,1KM						
	<b>VOLKSWAGEN POLO Classic (96-01)</b>										
		1.4		6K-V-022628	12.95	- ABS				BA2141	20887 17,3 +/Zub VW
		1.4		6K-V-022628	12.95	+ ABS				BA2145	21866 19,7 + VW
		1.6	55	6K-V-022628	05.96						
		1.7 SDI		6K-V-022628	07.97					BA2153	21866 15,3 + VW
1.9 SDI			6K-V-022628	12.95							
1.4			6K-V-022629		09.01						
1.6		55	6K-V-022629		09.01						
1.7 SDI			6K-V-022629		09.01		BA2018	21945 16,3 /S LUC			
1.9 SDI			6K-V-022629		09.01						
1.6		55		05.96	09.01						
1.6		74		05.96	09.01						
1.8				03.98	09.01 + MEX						
1.9 TDI		66		09.96	09.01						

								
<b>VOLKSWAGEN POLO Classic (96-01)</b>								
	1.9 TDI 2.0	81 85		06.98 03.99	09.01 09.01 + MEX		BA2018	21945 16,3 /S LUC
	1.4 1.4 1.6 1.7 SDI 1.9 SDI		6K-V-022628 6K-V-022628 6K-V-022628 6K-V-022628 6K-V-022628	12.95 12.95 05.96 07.97 12.95	- ABS + ABS		BAR10151 BAR12106	239 9,9 8,0 239 12,0 10,0
	1.4 1.6 1.7 SDI 1.9 SDI		6K-V-022629 6K-V-022629 6K-V-022629 6K-V-022629				BAR20123	239 20,0 18,0 VL
	1.6 1.6 1.8 1.9 TDI 1.9 TDI 2.0	55 74 66 81 85		05.96 05.96 03.98 09.96 06.98 03.99	09.01 09.01 09.01 + MEX 09.01 09.01 09.01 + MEX		BAR20128	256 20,0 18,0 VL
	1.4 1.6 1.6 1.7 SDI 1.8 1.9 SDI 1.9 TDI 1.9 TDI 2.0	55 74		12.95 11.95 05.96 07.97 03.98 12.95 09.96 06.98 03.99	09.01 09.01 09.01 09.01 09.01 + MEX 09.01 09.01 09.01 09.01 + MEX		BAH0005	2 L=435
	1.9 TDI 1.9 TDI 1.9 TDI	81 81 81		06.98 06.98 10.99	09.99 - ABS 09.99 + ABS 09.01		BA2032 BA2017 BA2017 BA2032	20961 15,2 /S LUC 20961 17,2 /S LUC 20961 17,2 /S LUC 20961 15,2 /S LUC
	1.9 TDI 1.9 TDI	81 81		06.98 10.99	09.99 09.01		BAR10111 BAR09124	ohne Sensorring <sup>1)</sup> 226 10,0 8,0 232 8,9 7,0
	1.4 1.6 1.6 1.7 SDI 1.8 1.9 SDI 1.9 TDI 1.9 TDI 2.0	55 74		10.99 10.99 10.99 10.99 10.99 10.99 10.99 10.99 10.99	09.01 09.01 09.01 09.01 09.01 + MEX 09.01 09.01 09.01 09.01 + MEX		BAH0033	2 L=140
	1.4 1.6	55		12.95 11.95	09.01 - ABS 09.01 - ABS		BAW1701	+ GG <sup>2)</sup> Rz 17,46
	1.4 1.6 1.6 1.7 SDI 1.8 1.9 SDI 1.9 TDI 2.0	55 74		12.95 11.95 12.95 07.97 03.98 12.95 09.96 03.99	09.01 + ABS 09.01 + ABS 09.01 09.01 + MEX 09.01 09.01 09.01 09.01 + MEX		BAW1905	Rz 19,05
	1.4 1.6	55		12.95 11.95	09.99 - ABS 09.99 - ABS		BAE5003	180 x 31 HEB
	1.4 1.4 1.6 1.6 1.6 1.7 SDI 1.8 1.9 SDI 1.9 TDI 2.0	55 74		12.95 10.99 11.95 10.99 12.95 07.97 03.98 12.95 09.96 03.99	09.99 + ABS 09.01 09.99 + ABS 09.01 09.01 09.01 + MEX 09.01 09.01 09.01 09.01 + MEX		BAE5001	200 x 40 HEB VW
<b>VOLKSWAGEN POLO Variant (97-01)</b>								
	1.4 1.4 1.6 1.7 SDI 1.9 SDI		6K-V-022628 6K-V-022628 6K-V-022628 6K-V-022628 6K-V-022628	03.97 03.97 05.97 08.97 03.97	- ABS + ABS		BA2141 BA2145	20887 17,3 +/Zub VW 21866 19,7 + VW
	1.4 1.6 1.7 SDI 1.9 SDI		6K-V-022629 6K-V-022629 6K-V-022629 6K-V-022629				BA2153	21866 15,3 + VW
	1.6 1.8 1.9 TDI 1.9 TDI	74 66 81		05.97 05.97 01.97 06.98	09.01 09.01 09.01 09.01		BA2018	21945 16,3 /S LUC

<sup>1)</sup> without sensor ring / senza sensori / sans secours ABS / sin anillo sensor ABS

<sup>2)</sup> + cast iron / + ghisa / + fonte grise / + fundición de gris



















**VOLKSWAGEN POLO Variant (97-01)**

















	1.4		6K-V-022628	03.97	- ABS	BAR10151		239 9,9 8,0	
	1.4		6K-V-022628	03.97	+ ABS	BAR12106		239 12,0 10,0	
	1.6	55	6K-V-022628	05.97					
	1.7 SDI		6K-V-022628	08.97					
	1.9 SDI		6K-V-022628	03.97					
	1.4		6K-V-022629		09.01	BAR20123		239 20,0 18,0 V L	
	1.6	55	6K-V-022629		09.01				
	1.7 SDI		6K-V-022629		09.01				
	1.9 SDI		6K-V-022629		09.01				
	1.6	74		05.97	09.01	BAR20128		256 20,0 18,0 V L	
	1.8			05.97	09.01				
	1.9 TDI	66		01.97	09.01				
	1.9 TDI	81		06.98	09.01				
		1.4			03.97	09.01	BAH0005	2	L=435
		1.6			05.97	09.01			
		1.7 SDI			08.97	09.01			
1.8				05.97	09.01				
	1.9 SDI			03.97	09.01				
	1.9 TDI	66		01.97	09.01				
	1.9 TDI	81		06.98	09.01				
		1.4			03.97	09.01	BA2017		20961 17,2 /S
1.6				05.97	09.01	BA2032		20961 15,2 /S	
1.7 SDI				08.97	09.01			LUC	
1.8				05.97	09.01			LUC	
	1.9 SDI			03.97	09.01				
	1.9 TDI	66		01.97	09.01				
	1.9 TDI	81		06.98	09.01				
		1.4			03.97	09.01	BAR09124		232 8,9 7,0
1.6			6K-X-610 000		09.01	BAH0033	2	L=140	
1.7 SDI			6K-X-610 000		09.01				
1.8			6K-X-610 000		09.01				
	1.9 SDI		6K-X-610 000		09.01				
	1.9 TDI	66	6K-X-610 000		09.01				
	1.9 TDI	81	6K-X-610 000		09.01				
		1.4			03.97	09.01	BAW1905		Rz 19,05
1.6				05.97	09.01				
1.7 SDI				08.97	09.01				
1.8				05.97	09.01				
	1.9 SDI			03.97	09.01				
	1.9 TDI	66		01.97	09.01				
		1.4			03.97	09.01	BAE5001		200 x 40 HEB
		1.6			05.97	09.01			VW
1.7 SDI				08.97	09.01				
1.8				05.97	09.01				
	1.9 SDI			03.97	09.01				
	1.9 TDI	66		01.97	09.01				

**VOLKSWAGEN SCIROCCO (08-)**



	1.4 TSI	90		09.08	PR: 1LJ,1ZA,1ZD,1ZE	BA2195		23587 19,6 +/WK	ATE
	1.4 TSI	118		08.08	PR: 1LJ,1ZA,1ZD,1ZE				
	2.0 R			11.09	PR: 1LJ,1ZA,1ZD,1ZE				
	2.0 TDI			10.08	PR: 1LJ,1ZA,1ZD,1ZE				
	2.0 TDI	125		05.09	PR: 1LJ,1ZA,1ZD,1ZE				
	2.0 TSI			08.08	PR: 1LJ,1ZA,1ZD,1ZE				
	1.4 TSI	90		09.08	PR: 1ZE	BAR25145		288 24,9 22,0 V L	
	1.4 TSI	118		08.08	PR: 1ZE				
	2.0 R			11.09	PR: 1ZE				
	2.0 TDI			10.08	PR: 1ZE				
	2.0 TDI	125		05.09	PR: 1ZE				
	2.0 TSI			08.08	PR: 1ZE				
	1.4 TSI	90		09.08	PR: 1LJ,1ZA,1ZD	BAR25158		312 25,0 22,0 V L	
	1.4 TSI	118		08.08	PR: 1LJ,1ZA,1ZD				
	2.0 R			11.09	PR: 1LJ,1ZA,1ZD				
	2.0 TDI			10.08	PR: 1LJ,1ZA,1ZD				
	2.0 TDI	125		05.09	PR: 1LJ,1ZA,1ZD				
	2.0 TSI			08.08	PR: 1LJ,1ZA,1ZD				
	1.4 TSI	90		09.08	PR: 1KD	BA2017		20961 17,2 /S	LUC
	1.4 TSI	118		08.08	PR: 1KD				
	2.0 R			11.09	PR: 1KD				
	2.0 TDI			10.08	PR: 1KD				
	2.0 TDI	125		05.09	PR: 1KD				
	2.0 TSI			08.08	PR: 1KD				
	1.4 TSI	90		09.08	PR: 1KE	BA2196		23914 16,3 /WE/S	LUC
	1.4 TSI	118		08.08	PR: 1KE				
	2.0 R			11.09	PR: 1KE				
	2.0 TDI			10.08	PR: 1KE				
	2.0 TDI	125		05.09	PR: 1KE				
	2.0 TSI			08.08	PR: 1KE				
	1.4 TSI	90		09.08	PR: 1KW	BA2196		23914 16,3 /WE/S	LUC
	1.4 TSI	118		08.08	PR: 1KW				
	2.0 R			11.09	PR: 1KW				
	2.0 TDI			10.08	PR: 1KW				
	2.0 TDI	125		05.09	PR: 1KW				
	2.0 TSI			08.08	PR: 1KW				

								
<b>VOLKSWAGEN SCIROCCO (08-)</b>								
	1.4 TSI 1.4 TSI 2.0 R 2.0 TDI 2.0 TDI 2.0 TSI	90 118  125	09.08 08.08 11.09 10.08 05.09 08.08	PR: 1KE PR: 1KE PR: 1KE PR: 1KE PR: 1KE PR: 1KE	BAR12158			256 12,0 10,0
<b>VOLKSWAGEN SHARAN I (95-10)</b>								
	1.8 T 1.9 TDI 1.9 TDI 2.0 2.8 2.8 Syncro	110 66 81 85	7M-W-070000 09.97 7M-W-070000 09.95 7M-W-070000 09.96 7M-W-070000 09.95 7M-W-070000 09.95 7M-W-070000 11.96		BA2147 BA2269			21848 19,5 + 21849 19,6 +/WK ATE ATE
	1.8 T 1.9 TDI 1.9 TDI 1.9 TDI 2.0 2.0 TDI 2.8 2.8 Syncro	110 7M-X-000001 66 7M-X-000001 81 7M-X-000001 85 85 7M-X-000001 85 7M-X-000001 7M-X-000001 7M-X-000001	7M-1-070000 7M-1-070000 7M-1-070000 7M-1-070000 05.00 7M-1-070000 7M-1-070000 11.05 7M-Y-050000 7M-Y-050000		BA2269			21849 19,6 +/WK ATE
	1.9 TDI 1.9 TDI 1.9 TDI 2.0 2.0 TDI	66 7M-2-000001 85 7M-2-000001 96 85 7M-2-000001 7M-2-000001	06.10 06.10 11.02 06.10 06.10		BA2231			23418 19,6 +/WK ATE
	1.8 T 1.9 TDI 1.9 TDI 4motion 2.8 2.8 Syncro	110 7M-2-000001 110 85 7M-1-000001 7M-1-000001	06.10 06.10 05.00 06.10 06.10		BA2318			23269 20,1 +/WK ATE
	1.8 T 1.9 TDI 1.9 TDI 1.9 TDI 2.0 2.8 2.8 Syncro	110 66 81 85 85	7M-1-070000 09.97 7M-1-070000 09.95 09.96 7M-1-070000 05.00 7M-1-070000 09.95 09.95 11.96	04.00	BAR25114			288 25,0 21,0 V L
	1.9 TDI 1.9 TDI 1.9 TDI 2.0 2.0 TDI	66 7M-2-000001 85 7M-2-000001 96 85 7M-2-000001	06.10 06.10 11.02 06.10 11.05		BAR26115			300 26,0 22,0 V L
	1.8 T 1.9 TDI 1.9 TDI 1.9 TDI 2.0 2.8 2.8 Syncro	110 66 81 85 85	7M-1-070000 09.97 7M-1-070000 09.95 09.96 7M-1-070000 05.00 7M-1-070000 09.95 09.95 11.96	04.00 + Frontantrieb 1)	BAH0007	2		L=450
	1.8 T 1.9 TDI 1.9 TDI 1.9 TDI 1.9 TDI 1.9 TDI 4motion 2.0 2.0 TDI 2.8 2.8 Syncro	110 7M-2-070001 66 7M-2-070001 85 96 110 85 7M-2-070001 85 7M-2-070001	06.10 06.10 05.00 11.02 06.05 06.10 06.10 11.05 05.00 05.00		BAH0027	2		L=455
	1.8 T 1.9 TDI 1.9 TDI 2.0 2.8 2.8 Syncro	110 66 81 85	09.97 09.95 09.96 09.95 09.95 11.96	04.00 04.00 04.00 04.00 04.00	BA2017			20961 17,2 /S LUC
	1.8 T 1.9 TDI 1.9 TDI 1.9 TDI 2.0 2.0 TDI	110 66 85 96 85	7M-1-070000 05.00 05.00 05.00 11.02 05.00 11.05	06.10 06.10 06.10 06.10 06.10	BA2228			20961 17,2 +/WK/S LUC
	1.8 T 1.9 TDI 1.9 TDI 4motion 2.8 2.8 Syncro	110 7M-2-000001 110 85	06.10 06.05 05.00 05.00 05.00	06.10 06.10 06.10 06.10 06.10	BA2200			23446 16,5 +/WK/S LUC
	1.8 T 1.9 TDI 1.9 TDI 1.9 TDI 1.9 TDI 2.0 2.0 TDI 2.8	110 66 81 85 96 85	7M-1-070000 09.97 09.95 09.96 05.00 11.02 09.95 11.05 09.95	06.10 04.00 06.10 06.10 06.10 06.10 06.10 04.00	BAR10223			268 9,9 8,0

1) + front wheel drive / + trazione anteriore / + traction avant / + traccion delantera

	   kW							
<b>VOLKSWAGEN SHARAN I (95-10)</b>								
	2.8 Syncro		11.96	04.00		BAR10223		268 9,9 8,0
	1.8 T	110 7M-2-000001		06.10		BAR13194		294 13,5 11,5
	1.9 TDI	110	06.05	06.10				
	1.9 TDI 4motion	85	05.00	06.10				
	2.8		05.00	06.10				
	2.8 Syncro		05.00	06.10				
<b>VOLKSWAGEN SHARAN II (10-)</b>								
	1.4 TSI	110	07.10		PR: 1LJ	BAR25158		312 25,0 22,0 V L
	2.0 TDI		07.10		PR: 1LJ			
	2.0 TDI	125	07.10		PR: 1LJ			
	2.0 TDI 4motion		05.11		PR: 1LJ			
	2.0 TSI	147	10.10		PR: 1LJ			
	1.4 TSI	110	07.10			BAR12169		282 12,0 10,0
	2.0 TDI		07.10					
	2.0 TDI	125	07.10					
	2.0 TDI 4motion		05.11					
	2.0 TSI	147	10.10					
<b>VOLKSWAGEN TIGUAN (07-)</b>								
	1.4 TSI		11.07		PR: 1LJ,1ZD	BAR25158		312 25,0 22,0 V L
	1.4 TSI	90	08.10		PR: 1LJ,1ZD			
	1.4 TSI 4motion		09.07		PR: 1LJ,1ZD			
	2.0 TDI	81	04.10		PR: 1LJ,1ZD			
	2.0 TDI	103	03.08		PR: 1LJ,1ZD			
	2.0 TDI 4motion		11.07		PR: 1LJ,1ZD			
	2.0 TDI 4motion		01.08		PR: 1LJ,1ZD			
	2.0 TFSI 4motion		02.08		PR: 1LJ,1ZD			
	2.0 TSI 4motion		11.07		PR: 1LJ,1ZD			
	1.4 TSI		11.07			BAR12169		282 12,0 10,0
	1.4 TSI	90	08.10					
	1.4 TSI 4motion		09.07					
	2.0 TDI	81	04.10					
	2.0 TDI	103	03.08					
	2.0 TDI 4motion		11.07					
	2.0 TDI 4motion		01.08					
	2.0 TFSI 4motion		02.08					
	2.0 TSI 4motion		11.07					
<b>VOLKSWAGEN TOUAREG I (03-10)</b>								
	2.5 R5 TDI		01.06	03.10	PR: 1LE	BAV1052	2	Warnkontakt L=420mm
	3.0 V6 TDI		01.06	03.10	PR: 1LE			
	3.0 V6 TDI	176	10.07	03.10	PR: 1LE			
	3.2 V6		11.02	12.05	PR: 1LE			
	3.6 V6 FSI	206	01.06	03.10	PR: 1LE			
	4.2 V8	228	01.06	11.06	PR: 1LE			
	4.2 V8 FSI	257	12.06	03.10	PR: 1LE			
	5.0 TDI R50	258	01.08	03.10	PR: 1LE			
	5.0 V10 TDI	230	01.06	03.10	PR: 1LE			
	6.0 W12	331	01.06	11.06	PR: 1LE			
	2.5 R5 TDI		01.03	03.10	PR: 1LC	BAV1052	2	Warnkontakt L=420mm
	3.0 V6 TDI		11.04	03.10	PR: 1LC			
	3.2 V6		11.02	12.05	PR: 1LC			
	3.6 V6 FSI	206	01.06	03.10	PR: 1LC			
	4.2 V8	228	12.02	11.06	PR: 1LC	BAV1052	2	Warnkontakt L=420mm
	4.2 V8 FSI	257	12.06	03.10	PR: 1LC			
	5.0 V10 TDI	230	11.02	03.10	PR: 1LC			
	6.0 W12	331	08.04	11.06	PR: 1LC			
	2.5 R5 TDI		01.03	03.10	PR: 1LF	BAV1052	2	Warnkontakt L=420mm
	3.0 V6 TDI		11.04	03.10	PR: 1LF			
	3.0 V6 TDI	176	10.07	03.10	PR: 1LF			
	3.2 V6		11.02	12.05	PR: 1LF			
	3.6 V6 FSI	206	01.06	03.10	PR: 1LF			
	4.2 V8	228	12.02	11.06	PR: 1LF	BAV1052	2	Warnkontakt L=420mm
	4.2 V8 FSI	257	12.06	03.10	PR: 1LF			
	5.0 TDI R50	258	01.08	03.10	PR: 1LF			
	5.0 V10 TDI	230	11.02	03.10	PR: 1LF			
	6.0 W12	331	08.04	11.06	PR: 1LF			
	2.5 R5 TDI		01.03	03.10	PR: 1KF	BAV1053	2	Warnkontakt L=255mm
	3.0 V6 TDI		11.04	03.10	PR: 1KF			
	3.0 V6 TDI	176	10.07	03.10	PR: 1KF			
	3.2 V6		11.02	12.05	PR: 1KF			
	3.6 V6 FSI	206	01.06	03.10	PR: 1KF			
	4.2 V8	228	12.02	11.06	PR: 1KF			
	4.2 V8 FSI	257	12.06	03.10	PR: 1KF			
	5.0 TDI R50	258	01.08	03.10	PR: 1KF			
	5.0 V10 TDI	230	11.02	03.10	PR: 1KF			
	6.0 W12	331	08.04	11.06	PR: 1KF			
	2.5 R5 TDI		01.03	03.10	PR: 1KD,2ED	BAV1053	2	Warnkontakt L=255mm
	3.0 V6 TDI		11.04	03.10	PR: 1KD,2ED			
	3.0 V6 TDI	176	10.07	03.10	PR: 1KD,2ED			
	3.6 V6 FSI	206	01.06	03.10	PR: 1KD,2ED			
	4.2 V8 FSI	257	12.06	03.10	PR: 1KD,2ED			
	5.0 TDI R50	258	01.08	03.10	PR: 1KD,2ED			
	5.0 V10 TDI	230	11.02	03.10	PR: 1KD,2ED			

**VOLKSWAGEN TOURAN (03-)**

	1.2 TSI	77	05.10	PR: 1ZA,1ZD,1ZE,1ZP,1LJ	BA2195		23587 19,6 +WK	ATE
	1.4 FSI	103	01.06	PR: 1ZA,1ZD,1ZE,1ZP,1LJ				
	1.4 TSI	103	09.06	PR: 1ZA,1ZD,1ZE,1ZP,1LJ				
	1.4 TSI	125	11.06	PR: 1ZA,1ZD,1ZE,1ZP,1LJ				
	1.4 TSI EcoFuel	110	05.09	04.10 PR: 1ZA,1ZD,1ZE,1ZP,1LJ				
	1.6	75	07.03	PR: 1ZA,1ZD,1ZE,1ZP,1LJ				
	1.6 FSI	85	02.03	PR: 1ZA,1ZD,1ZE,1ZP,1LJ				
	1.6 TDI	85	05.10	PR: 1ZA,1ZD,1ZE,1ZP,1LJ				
	1.9 TDI	66	11.04	PR: 1ZA,1ZD,1ZE,1ZP,1LJ				
	1.9 TDI	74	02.03	PR: 1ZA,1ZD,1ZE,1ZP,1LJ				
	1.9 TDI	77	08.03	PR: 1ZA,1ZD,1ZE,1ZP,1LJ				
	2.0 Eco Fuel	80	02.06	PR: 1ZA,1ZD,1ZE,1ZP,1LJ				
2.0 FSI	85	10.04	PR: 1ZA,1ZD,1ZE,1ZP,1LJ					
2.0 FSI	110	10.03	PR: 1ZA,1ZD,1ZE,1ZP,1LJ					
2.0 TDI	81	02.03	PR: 1ZA,1ZD,1ZE,1ZP,1LJ					
2.0 TDI	103	08.03	PR: 1ZA,1ZD,1ZE,1ZP,1LJ					
2.0 TDI	125	02.06	PR: 1ZA,1ZD,1ZE,1ZP,1LJ					
	1.2 TSI	77	05.10	PR: 1ZE,1ZP	BAR25145		288 24,9 22,0 V L	
	1.4 FSI	103	01.06	PR: 1ZE,1ZP				
	1.4 TSI	103	09.06	PR: 1ZE,1ZP				
	1.4 TSI	125	11.06	PR: 1ZE,1ZP				
	1.4 TSI EcoFuel	110	05.09	04.10 PR: 1ZE,1ZP				
	1.6	75	07.03	PR: 1ZE,1ZP				
	1.6 FSI	85	02.03	PR: 1ZE,1ZP				
	1.6 TDI	85	05.10	PR: 1ZE,1ZP				
	1.9 TDI	66	11.04	PR: 1ZE,1ZP				
	1.9 TDI	74	02.03	PR: 1ZE,1ZP				
	1.9 TDI	77	08.03	PR: 1ZE,1ZP				
	2.0 Eco Fuel	80	02.06	PR: 1ZE,1ZP				
2.0 FSI	85	10.04	PR: 1ZE,1ZP					
2.0 FSI	110	10.03	PR: 1ZE,1ZP					
2.0 TDI	81	02.03	PR: 1ZE,1ZP					
2.0 TDI	103	08.03	PR: 1ZE,1ZP					
2.0 TDI	125	02.06	PR: 1ZE,1ZP					
	1.2 TSI	77	05.10	PR: 1LJ,1ZA,1ZD	BAR25158		312 25,0 22,0 V L	
	1.4 FSI	103	01.06	PR: 1LJ,1ZA,1ZD				
	1.4 TSI	103	09.06	PR: 1LJ,1ZA,1ZD				
	1.4 TSI	125	11.06	PR: 1LJ,1ZA,1ZD				
	1.4 TSI EcoFuel	110	05.09	04.10 PR: 1LJ,1ZA,1ZD				
	1.6	75	07.03	PR: 1LJ,1ZA,1ZD				
	1.6 FSI	85	02.03	PR: 1LJ,1ZA,1ZD				
	1.6 TDI	85	05.10	PR: 1LJ,1ZA,1ZD				
	1.9 TDI	66	11.04	PR: 1LJ,1ZA,1ZD				
	1.9 TDI	74	02.03	PR: 1LJ,1ZA,1ZD				
	1.9 TDI	77	08.03	PR: 1LJ,1ZA,1ZD				
	2.0 Eco Fuel	80	02.06	PR: 1LJ,1ZA,1ZD				
2.0 FSI	85	10.04	PR: 1LJ,1ZA,1ZD					
2.0 FSI	110	10.03	PR: 1LJ,1ZA,1ZD					
2.0 TDI	81	02.03	PR: 1LJ,1ZA,1ZD					
2.0 TDI	103	08.03	PR: 1LJ,1ZA,1ZD					
2.0 TDI	125	02.06	PR: 1LJ,1ZA,1ZD					
	1.4 FSI	103	01.06	PR: 1KF,1KJ	BA2196		23914 16,3 /WE/S	LUC
	1.4 TSI	103	09.06	PR: 1KF,1KJ				
	1.4 TSI	125	11.06	PR: 1KF,1KJ				
	1.4 TSI EcoFuel	110	05.09	04.10 PR: 1KF,1KJ				
	1.6	75	07.03	PR: 1KF,1KJ				
	1.6 FSI	85	02.03	PR: 1KF,1KJ				
	1.6 TDI	85	05.10	PR: 1KF,1KJ				
	1.9 TDI	66	11.04	PR: 1KF,1KJ				
	1.9 TDI	74	02.03	PR: 1KF,1KJ				
	1.9 TDI	77	08.03	PR: 1KF,1KJ				
	2.0 Eco Fuel	80	02.06	PR: 1KF,1KJ				
	2.0 FSI	85	10.04	PR: 1KF,1KJ				
2.0 FSI	110	10.03	PR: 1KF,1KJ					
2.0 TDI	81	02.03	PR: 1KF,1KJ					
2.0 TDI	103	08.03	PR: 1KF,1KJ					
2.0 TDI	125	02.06	PR: 1KF,1KJ					
	1.2 TSI	77	05.10	PR: 1KE	BA2196		23914 16,3 /WE/S	LUC
	1.4 FSI	103	01.06	PR: 1KE				
	1.4 TSI	103	09.06	PR: 1KE				
	1.4 TSI	125	11.06	PR: 1KE				
	1.4 TSI EcoFuel	110	05.09	04.10 PR: 1KE				
	1.6	75	07.03	PR: 1KE				
	1.6 FSI	85	02.03	PR: 1KE				
	1.6 TDI	85	05.10	PR: 1KE				
	1.9 TDI	66	11.04	PR: 1KE				
	1.9 TDI	74	02.03	PR: 1KE				
	1.9 TDI	77	08.03	PR: 1KE				
	2.0 Eco Fuel	80	02.06	PR: 1KE				
2.0 FSI	85	10.04	PR: 1KE					
2.0 FSI	110	10.03	PR: 1KE					
2.0 TDI	81	02.03	PR: 1KE					
2.0 TDI	103	08.03	PR: 1KE					
2.0 TDI	125	02.06	PR: 1KE					

**VOLKSWAGEN TOURAN (03-)**

	1.2 TSI	77		<b>05.10</b>	PR: 1KE,1KF	<b>BAR12158</b>		256 12,0 10,0			
	1.4 FSI	103		<b>01.06</b>	PR: 1KE,1KF						
	1.4 TSI	103		<b>09.06</b>	PR: 1KE,1KF						
	1.4 TSI	125		<b>11.06</b>	PR: 1KE,1KF						
	1.4 TSI EcoFuel	110		<b>05.09</b>	PR: 1KE,1KF						
	1.6	75		<b>07.03</b>	PR: 1KE,1KF						
	1.6 FSI	85		<b>02.03</b>	PR: 1KE,1KF						
	1.6 TDI			<b>05.10</b>	PR: 1KE,1KF						
	1.9 TDI	66		<b>11.04</b>	PR: 1KE,1KF						
	1.9 TDI	74		<b>02.03</b>	PR: 1KE,1KF						
	1.9 TDI	77		<b>08.03</b>	PR: 1KE,1KF						
	2.0 Eco Fuel	80		<b>02.06</b>	PR: 1KE,1KF						
	2.0 FSI	85		<b>10.04</b>	PR: 1KE,1KF						
	2.0 FSI	110		<b>10.03</b>	PR: 1KE,1KF						
	2.0 TDI	81		<b>02.03</b>	PR: 1KE,1KF						
	2.0 TDI	103		<b>08.03</b>	PR: 1KE,1KF						
	2.0 TDI	125		<b>02.06</b>	PR: 1KE,1KF						
	1.2 TSI	77		<b>05.10</b>	PR: 1KJ				<b>BAR12169</b>		282 12,0 10,0
	1.4 FSI	103		<b>01.06</b>	PR: 1KJ						
	1.4 TSI	103		<b>09.06</b>	PR: 1KJ						
1.4 TSI	125		<b>11.06</b>	PR: 1KJ							
1.4 TSI EcoFuel	110		<b>05.09</b>	PR: 1KJ							
1.6	75		<b>07.03</b>	PR: 1KJ							
1.6 FSI	85		<b>02.03</b>	PR: 1KJ							
1.6 TDI			<b>05.10</b>	PR: 1KJ							
1.9 TDI	66		<b>11.04</b>	PR: 1KJ							
1.9 TDI	74		<b>02.03</b>	PR: 1KJ							
1.9 TDI	77		<b>08.03</b>	PR: 1KJ							
2.0 Eco Fuel	80		<b>02.06</b>	PR: 1KJ							
2.0 FSI	85		<b>10.04</b>	PR: 1KJ							
2.0 FSI	110		<b>10.03</b>	PR: 1KJ							
2.0 TDI	81		<b>02.03</b>	PR: 1KJ							
2.0 TDI	103		<b>08.03</b>	PR: 1KJ							
2.0 TDI	125		<b>02.06</b>	PR: 1KJ							

**VOLKSWAGEN TRANSPORTER (T4) (90-03)**

	1.9 D	70-P-160001	70-X-250000		PR: 1LP	<b>BA2049</b>		21479 19,2 /S	<b>LUC</b>
	1.9 TD	70-P-160001	70-X-250000		PR: 1LP				
	2.0	70-P-160001	70-X-250000		PR: 1LP				
	2.4 D	70-P-160001	70-X-250000		PR: 1LP				
	2.4 D Syncro		70-X-250000	<b>11.92</b>	PR: 1LP				
	2.5	70-P-160001	70-X-250000		PR: 1LP				
	2.5 Syncro		70-X-250000	<b>11.92</b>	PR: 1LP				
	2.5 TDI		70-X-250000	<b>09.95</b>	PR: 1LP				
	2.5 TDI Syncro		70-X-250000	<b>09.95</b>	PR: 1LP				
	2.8		70-X-250000	<b>11.95</b>	PR: 1LP				
1.9 D	70-Y-000001			<b>09.03</b>	PR: 1LP	<b>BA2321</b>		21479 19,2 +/WK/S	<b>LUC</b>
1.9 TD	70-Y-000001			<b>09.03</b>	PR: 1LP				
2.0	70-Y-000001			<b>09.03</b>	PR: 1LP				
2.4 D	70-Y-000001			<b>09.03</b>	PR: 1LP				
2.4 D Syncro	70-Y-000001			<b>09.03</b>	PR: 1LP				
2.5	70-Y-000001			<b>09.03</b>	PR: 1LP				
2.5 Syncro	70-Y-000001			<b>09.03</b>	PR: 1LP				
2.5 TDI	70-Y-000001			<b>09.03</b>	PR: 1LP				
2.5 TDI Syncro	70-Y-000001			<b>09.03</b>	PR: 1LP				
2.8	70-Y-000001			<b>09.03</b>	PR: 1LP				
1.9 D		70-X-250000	<b>07.90</b>	PR: 1LE	<b>BA2322</b>		21635 18,2 + /Zub	<b>LUC</b>	
1.9 TD		70-X-250000	<b>10.92</b>	PR: 1LE					
2.0		70-X-250000	<b>07.90</b>	PR: 1LE					
2.4 D		70-X-250000	<b>07.90</b>	PR: 1LE					
2.4 D Syncro		70-X-250000	<b>11.92</b>	PR: 1LE					
2.5		70-X-250000	<b>10.90</b>	PR: 1LE					
2.5 Syncro		70-X-250000	<b>11.92</b>	PR: 1LE					
2.5 TDI		70-X-250000	<b>09.95</b>	PR: 1LE					
2.5 TDI Syncro		70-X-250000	<b>09.95</b>	PR: 1LE					
2.8		70-X-250000	<b>11.95</b>	PR: 1LE					
1.9 D		70-X-250000	<b>05.96</b>	PR: 1LU	<b>BA2171</b>		21883 19,6 +	<b>ATE</b>	
1.9 TD		70-X-250000	<b>05.96</b>	PR: 1LU					
2.0		70-X-250000	<b>05.96</b>	PR: 1LU					
2.4 D		70-X-250000	<b>05.96</b>	PR: 1LU					
2.4 D Syncro		70-X-250000	<b>07.95</b>	PR: 1LU					
2.5		70-X-250000	<b>05.96</b>	PR: 1LU					
2.5 Syncro		70-X-250000	<b>07.95</b>	PR: 1LU					
2.5 TDI		70-X-250000	<b>05.96</b>	PR: 1LU					
2.5 TDI Syncro		70-X-250000	<b>09.95</b>	PR: 1LU					
2.8		70-X-250000	<b>11.95</b>	PR: 1LU					
1.9 D	70-Y-000001			<b>09.03</b>	PR: 1LU	<b>BA2201</b>		21885 19,6 +/WK	<b>ATE</b>
1.9 TD	70-Y-000001			<b>09.03</b>	PR: 1LU				
2.0	70-Y-000001			<b>09.03</b>	PR: 1LU				
2.4 D	70-Y-000001			<b>09.03</b>	PR: 1LU				
2.4 D Syncro	70-Y-000001			<b>09.03</b>	PR: 1LU				
2.5	70-Y-000001			<b>09.03</b>	PR: 1LU				
2.5 Syncro	70-Y-000001			<b>09.03</b>	PR: 1LU				
2.5 TDI	70-Y-000001			<b>09.03</b>	PR: 1LU				
2.5 TDI Syncro	70-Y-000001			<b>09.03</b>	PR: 1LU				
2.8	70-Y-000001			<b>09.03</b>	PR: 1LU				

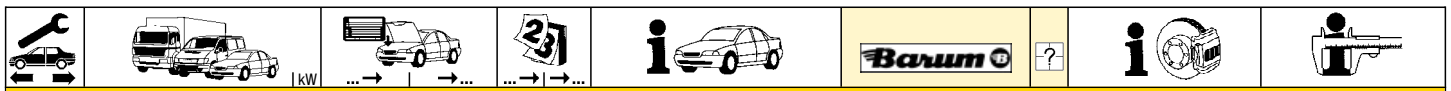

**VOLKSWAGEN TRANSPORTER (T4) (90-03)**

	1.9 D 1.9 TD 2.0 2.4 D 2.4 D Syncro 2.5 2.5 Syncro 2.5 TDI 2.5 TDI Syncro 2.8	70-1-000955 70-1-000955 70-1-000955 70-1-000955 70-1-000955 70-1-000955 70-1-000955 70-1-000955		09.03 PR: 1LB 09.03 PR: 1LB 09.03 PR: 1LB 09.03 PR: 1LB 07.95 09.03 PR: 1LB 09.03 PR: 1LB 07.95 09.03 PR: 1LB 09.03 PR: 1LB 09.95 09.03 PR: 1LB 09.03 PR: 1LB	BA2318		23269 20,1 +/WK	ATE
	1.9 D 1.9 TD 2.0 2.4 D 2.4 D Syncro 2.5 2.5 Syncro 2.5 TDI 2.5 TDI Syncro	70-P-160001 70-P-160001 70-P-160001 70-P-160001 70-P-160001		04.96 PR: 1LP 04.96 PR: 1LP 04.96 PR: 1LP 04.96 PR: 1LP 11.92 04.96 PR: 1LP 04.96 PR: 1LP 11.92 04.96 PR: 1LP 09.95 04.96 PR: 1LP 09.95 04.96 PR: 1LP	BAR18105		282 18,0 15,0	
	1.9 D 1.9 TD 2.0 2.4 D 2.4 D Syncro 2.5 2.5 Syncro 2.5 TDI 2.5 TDI Syncro 2.8			05.96 09.03 PR: 1LP 05.96 09.03 PR: 1LP 05.96 09.03 PR: 1LP 05.96 09.03 PR: 1LP 05.96 09.03 PR: 1LP 05.96 09.03 PR: 1LP 05.96 09.03 PR: 1LP 05.96 09.03 PR: 1LP 05.96 09.03 PR: 1LP 11.95 09.03 PR: 1LP	BAR18111		282 18,0 15,0 L	
	1.9 D 1.9 TD 2.0 2.4 D 2.4 D Syncro 2.5 2.5 Syncro 2.5 TDI			07.90 04.96 PR: 1LE,1LU 10.92 04.96 PR: 1LE,1LU 07.90 04.96 PR: 1LE,1LU 07.90 04.96 PR: 1LE,1LU 11.92 06.95 PR: 1LE,1LU 10.90 04.96 PR: 1LE,1LU 11.92 06.95 PR: 1LE,1LU 09.95 04.96 PR: 1LE,1LU	BAR24118		280 24,0 20,0 V L	
	1.9 D 1.9 TD 2.0 2.4 D 2.4 D Syncro 2.5 2.5 Syncro 2.5 TDI 2.5 TDI Syncro 2.8			05.96 09.03 PR: 1LE,1LU 05.96 09.03 PR: 1LE,1LU 05.96 09.03 PR: 1LE,1LU 05.96 09.03 PR: 1LE,1LU 07.95 09.03 PR: 1LE,1LU 05.96 09.03 PR: 1LE,1LU 07.95 09.03 PR: 1LE,1LU 05.96 09.03 PR: 1LE,1LU 09.95 09.03 PR: 1LE,1LU 11.95 09.03 PR: 1LE,1LU	BAR24128		280 24,0 20,0 V L	
	1.9 D 1.9 TD 2.0 2.4 D 2.5 2.5 TDI 2.8	70-1-000954 70-1-000954 70-1-000954 70-1-000954 70-1-000954 70-1-000954		05.97 PR: 1LB 05.97 PR: 1LB 05.97 PR: 1LB 05.97 PR: 1LB 05.97 PR: 1LB 05.97 PR: 1LB	BAR26115		300 26,0 22,0 V L	
	1.9 D 1.9 TD 2.0 2.4 D 2.4 D Syncro 2.5 2.5 Syncro 2.5 TDI 2.5 TDI Syncro 2.8			08.95 04.97 08.95 04.97 08.95 04.97 08.95 04.97 08.95 04.97 08.95 04.97 09.95 04.97 09.95 04.97 05.96 04.97	BAH0022	2	L=345	
	1.9 D 1.9 TD 2.0 2.4 D 2.4 D Syncro 2.5 2.5 Syncro 2.5 TDI 2.5 TDI Syncro 2.8	70-X-250000 70-X-250000 70-X-250000 70-X-250000 70-X-250000 70-X-250000 70-X-250000 70-X-250000 70-X-250000		05.97 05.97 05.97 05.97 05.97 05.97 05.97 05.97 05.97	BAH0022	2	- Belagverschleiß-Anzeige <sup>1)</sup>	L=345
	1.9 D 1.9 TD 2.0 2.4 D 2.4 D Syncro 2.5 2.5 Syncro 2.5 TDI 2.5 TDI Syncro 2.8			05.99 09.03 05.99 09.03 05.99 09.03 05.99 09.03 05.99 09.03 05.99 09.03 05.99 09.03 05.99 09.03 05.99 09.03	BAH0022	<input type="checkbox"/> PR: 2E2/ + Belagverschleiß-Anzeige <sup>2)</sup>	L=345	

<sup>1)</sup> - pad wear indicator / - indicatore usura guarniz.fr. / - indicat.d'usure d.garnitures / - indicad.desgaste la guarnic.

<sup>2)</sup> PR: 2E2/ + Brake wear indicator / PR: 2E2/ + Indicatore d'usura guarnizioni freni / PR: 2E2/ + Indicateur d'usure des garnitures / PR: 2E2/ + Indicador de desgaste de pastillas

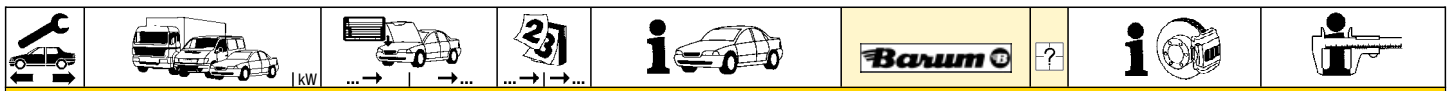

**VOLKSWAGEN TRANSPORTER (T4) (90-03)**

	1.9 D	70-T-200000		09.03	PR: 2E2	BA2202		23224 16,5 +/WK/S	LUC
	1.9 TD	70-T-200000		09.03	PR: 2E2				
	2.0	70-T-200000		09.03	PR: 2E2				
	2.4 D	70-T-200000		09.03	PR: 2E2				
	2.4 D Syncro	70-T-200000		09.03	PR: 2E2				
	2.5	70-T-200000		09.03	PR: 2E2				
	2.5 Syncro	70-T-200000		09.03	PR: 2E2				
	2.5 TDI	70-T-200000		09.03	PR: 2E2				
	2.5 TDI Syncro	70-T-200000		09.03	PR: 2E2				
	2.8	70-T-200000		09.03	PR: 2E2				
	1.9 D		05.97	09.03	PR: 2E3	BA2200		23446 16,5 +/WK/S	LUC
	1.9 TD		05.97	09.03	PR: 2E3				
	2.0		05.97	09.03	PR: 2E3				
	2.4 D		05.97	09.03	PR: 2E3				
	2.4 D Syncro		05.97	09.03	PR: 2E3				
	2.5		05.97	09.03	PR: 2E3				
	2.5 Syncro		05.97	09.03	PR: 2E3				
	2.5 TDI		05.97	09.03	PR: 2E3				
	2.5 TDI Syncro		05.97	09.03	PR: 2E3				
	2.8		05.97	09.03	PR: 2E3				
	1.9 D	70-T-200000		09.03	PR: 2E2	BAR12138		280 12,0 10,0	
	1.9 TD	70-T-200000		09.03	PR: 2E2				
	2.0	70-T-200000		09.03	PR: 2E2				
	2.4 D	70-T-200000		09.03	PR: 2E2				
	2.4 D Syncro		05.96	09.03	PR: 2E2				
	2.5	70-T-200000		09.03	PR: 2E2				
	2.5 Syncro		05.96	09.03	PR: 2E2				
	2.5 TDI	70-T-200000		09.03	PR: 2E2				
	2.5 TDI Syncro		05.96	09.03	PR: 2E2				
	2.8	70-T-200000		09.03	PR: 2E2				
	1.9 D		05.97	09.03	PR: 2E3	BAR13194		294 13,5 11,5	
	1.9 TD		05.97	09.03	PR: 2E3				
	2.0		05.97	09.03	PR: 2E3				
	2.4 D		05.97	09.03	PR: 2E3				
	2.4 D Syncro		05.97	09.03	PR: 2E3				
	2.5		05.97	09.03	PR: 2E3				
	2.5 Syncro		05.97	09.03	PR: 2E3				
	2.5 TDI		05.97	09.03	PR: 2E3				
	2.5 TDI Syncro		05.97	09.03	PR: 2E3				
	2.8		05.97	09.03	PR: 2E3				
	1.8		12.90	07.92		BAH0011	2	L=160	
	1.9 D	70-T-199999	07.90						
	1.9 TD	70-T-199999	10.92						
	2.0	70-T-199999	07.90						
	2.4 D	70-T-199999	07.90						
	2.4 D Syncro	70-T-199999	11.92						
	2.5	70-T-199999	10.90						
	2.5 Syncro	70-T-199999	11.92						
	2.5 TDI	70-T-199999	09.95						
	2.5 TDI Syncro	70-T-199999	09.95						
	1.9 D	70-T-200000		09.03		BAH0011 BAH0003	2 2	- Schlechtwegeausführung <sup>1)</sup> - 16" Rad/ am Bremsattel <sup>2)</sup>	L=160 L=160
	1.9 TD	70-T-200000		09.03					
	2.0	70-T-200000		09.03					
	2.4 D	70-T-200000		09.03					
	2.4 D Syncro	70-T-200000		09.03					
	2.5	70-T-200000		09.03					
	2.5 Syncro	70-T-200000		09.03					
	2.5 TDI	70-T-200000		09.03					
	2.5 TDI Syncro	70-T-200000		09.03					
	2.8	70-T-200000		09.03					
	1.8		12.90	07.92		BAW2002		Rz 20,64	
	1.9 D	70-T-199999	07.90						
	1.9 TD	70-T-199999	10.92						
	2.0	70-T-199999	07.90						
	2.4 D	70-T-199999	07.90						
	2.4 D Syncro	70-T-199999	11.92						
	2.5	70-T-199999	10.90						
	2.5 Syncro	70-T-199999	11.92						
	2.5 TDI	70-T-199999	09.95						
	2.5 TDI Syncro	70-T-199999	09.95						
	1.8		12.90	07.92		BAE5024		268 x 56 HEB	
	1.9 D	70-T-199999	07.90						
	1.9 TD	70-T-199999	10.92						
	2.0	70-T-199999	07.90						
	2.4 D	70-T-199999	07.90						
	2.4 D Syncro	70-T-199999	11.92						
	2.5	70-T-199999	10.90						
	2.5 Syncro	70-T-199999	11.92						
	2.5 TDI	70-T-199999	09.95						
	2.5 TDI Syncro	70-T-199999	09.95						

**VOLKSWAGEN TRANSPORTER (T5) (03-)**

	1.9 TDI	62	01.06	PR: 2E3	BA2242		23746 17,5 +/WK	ATE
	1.9 TDI	63	04.03	PR: 2E3				
	1.9 TDI	75	06.06	PR: 2E3				
	1.9 TDI	77	04.03	PR: 2E3				
↓	↓							

1) - rough road construction / - versione per percorsi accidentati / - version pour mauvaise route / - versión 4x4  
 2) - 16" wheel/on the br.caliper / - ruota 16", sulla pinza freno / - roue 16", sur étrier frein / - rueda 16", la pinza d. freno

**VOLKSWAGEN TRANSPORTER (T5) (03-)**

	2.0			06.03	PR: 2E3	BA2242		23746 17,5 +/WK	ATE
	2.0 BiTDI	132		09.09	PR: 2E3				
	2.0 BiTDI 4motion	132		09.09	PR: 2E3				
	2.0 TDI	62		09.09	PR: 2E3				
	2.0 TDI	75		09.09	PR: 2E3				
	2.0 TDI	84		05.11	PR: 2E3				
	2.0 TDI	100		05.10	PR: 2E3				
	2.0 TDI	103		09.09	PR: 2E3				
	2.0 TDI 4motion	100		05.10	PR: 2E3				
	2.0 TDI 4motion	103		09.09	PR: 2E3				
	2.0 TSI	150		05.11	PR: 2E3				
	2.0 TSI 4motion	150		07.11	PR: 2E3				
	2.5 TDI			02.03	PR: 2E3				
	2.5 TDI	96		02.03	PR: 2E3				
	2.5 TDI 4motion	96		07.04	PR: 2E3				
	2.5 TDI 4motion	128		07.04	PR: 2E3				
	3.2 V6			02.03	PR: 2E3				
	3.2 V6 4motion			07.04	PR: 2E3				
	1.9 TDI	62	7H-A-050000	01.06	PR: 2E4	BA2242		23746 17,5 +/WK	ATE
	1.9 TDI	63	7H-A-050000	04.03	PR: 2E4				
	1.9 TDI	75	7H-A-050000	06.06	PR: 2E4				
	1.9 TDI	77	7H-A-050000	04.03	PR: 2E4				
	2.0		7H-A-050000	06.03	PR: 2E4				
	2.0 BiTDI	132	7H-A-050000	09.09	PR: 2E4				
	2.0 BiTDI 4motion	132	7H-A-050000	09.09	PR: 2E4				
	2.0 TDI	62	7H-A-050000	09.09	PR: 2E4				
	2.0 TDI	75	7H-A-050000	09.09	PR: 2E4				
	2.0 TDI	103	7H-A-050000	09.09	PR: 2E4				
	2.0 TDI 4motion	103	7H-A-050000	09.09	PR: 2E4				
	2.5 TDI		7H-A-050000	02.03	PR: 2E4				
	2.5 TDI	96	7H-A-050000	02.03	PR: 2E4				
	2.5 TDI 4motion	96	7H-A-050000	07.04	PR: 2E4				
	2.5 TDI 4motion	128	7H-A-050000	07.04	PR: 2E4				
	3.2 V6		7H-A-050000	02.03	PR: 2E4				
	3.2 V6 4motion		7H-A-050000	07.04	PR: 2E4				
	1.9 TDI	62	7J-A-010000	01.06	PR: 2E4	BA2242		23746 17,5 +/WK	ATE
	1.9 TDI	63	7J-A-010000	04.03	PR: 2E4				
	1.9 TDI	75	7J-A-010000	06.06	PR: 2E4				
	1.9 TDI	77	7J-A-010000	04.03	PR: 2E4				
	2.0		7J-A-010000	06.03	PR: 2E4				
	2.0 BiTDI	132	7J-A-010000	09.09	PR: 2E4				
	2.0 BiTDI 4motion	132	7J-A-010000	09.09	PR: 2E4				
	2.0 TDI	62	7J-A-010000	09.09	PR: 2E4				
	2.0 TDI	75	7J-A-010000	09.09	PR: 2E4				
	2.0 TDI	103	7J-A-010000	09.09	PR: 2E4				
	2.0 TDI 4motion	103	7J-A-010000	09.09	PR: 2E4				
	2.5 TDI		7J-A-010000	02.03	PR: 2E4				
	2.5 TDI	96	7J-A-010000	02.03	PR: 2E4				
	2.5 TDI 4motion	96	7J-A-010000	07.04	PR: 2E4				
	2.5 TDI 4motion	128	7J-A-010000	07.04	PR: 2E4				
	3.2 V6		7J-A-010000	02.03	PR: 2E4				
	3.2 V6 4motion		7J-A-010000	07.04	PR: 2E4				
	1.9 TDI	63	7H-5-120000	04.03	PR: OWL,OWN,OWM,OWP,OWQ	BA2243		23326 17,4 /WK/S	LUC
	1.9 TDI	77	7H-5-120000	04.03	PR: OWL,OWN,OWM,OWP,OWQ				
	2.0		7H-5-120000	06.03	PR: OWL,OWN,OWM,OWP,OWQ				
	2.5 TDI		7H-5-120000	02.03	PR: OWL,OWN,OWM,OWP,OWQ				
	2.5 TDI	96	7H-5-120000	02.03	PR: OWL,OWN,OWM,OWP,OWQ				
	2.5 TDI 4motion	96	7H-5-120000	07.04	PR: OWL,OWN,OWM,OWP,OWQ				
	2.5 TDI 4motion	128	7H-5-120000	07.04	PR: OWL,OWN,OWM,OWP,OWQ				
	3.2 V6		7H-5-120000	02.03	PR: OWL,OWN,OWM,OWP,OWQ				
	3.2 V6 4motion		7H-5-120000	07.04	PR: OWL,OWN,OWM,OWP,OWQ				
	1.9 TDI	62	7J-A-010000	01.06	PR: 2E3,2E4	BA2243		23326 17,4 /WK/S	LUC
	1.9 TDI	63	7J-A-010000	04.03	PR: 2E3,2E4				
	1.9 TDI	75	7J-A-010000	06.06	PR: 2E3,2E4				
	1.9 TDI	77	7J-A-010000	04.03	PR: 2E3,2E4				
	2.0		7J-A-010000	06.03	PR: 2E3,2E4				
	2.0 BiTDI	132	7J-A-010000	09.09	PR: 2E3,2E4				
	2.0 BiTDI 4motion	132	7J-A-010000	09.09	PR: 2E3,2E4				
	2.0 TDI	62	7J-A-010000	09.09	PR: 2E3,2E4				
	2.0 TDI	75	7J-A-010000	09.09	PR: 2E3,2E4				
	2.0 TDI	103	7J-A-010000	09.09	PR: 2E3,2E4				
	2.0 TDI 4motion	103	7J-A-010000	09.09	PR: 2E3,2E4				
	2.5 TDI		7J-A-010000	02.03	PR: 2E3,2E4				
	2.5 TDI	96	7J-A-010000	02.03	PR: 2E3,2E4				
	2.5 TDI 4motion	96	7J-A-010000	07.04	PR: 2E3,2E4				
	2.5 TDI 4motion	128	7J-A-010000	07.04	PR: 2E3,2E4				
	3.2 V6		7J-A-010000	02.03	PR: 2E3,2E4				
	3.2 V6 4motion		7J-A-010000	07.04	PR: 2E3,2E4				
	1.9 TDI	62	7J-8-000788	01.06	PR: OWR,OE0,OE9	BA2327		24367 19,1 +/WK	ATE
	1.9 TDI	63	7J-8-000788	04.03	PR: OWR,OE0,OE9				
	1.9 TDI	75	7J-8-000788	06.06	PR: OWR,OE0,OE9				
	1.9 TDI	77	7J-8-000788	04.03	PR: OWR,OE0,OE9				
	2.0		7J-8-000788	06.03	PR: OWR,OE0,OE9				
	2.5 TDI		7J-8-000788	02.03	PR: OWR,OE0,OE9				
	2.5 TDI	96	7J-8-000788	02.03	PR: OWR,OE0,OE9				
	2.5 TDI 4motion	96	7J-8-000788	07.04	PR: OWR,OE0,OE9				
	2.5 TDI 4motion	128	7J-8-000788	07.04	PR: OWR,OE0,OE9				



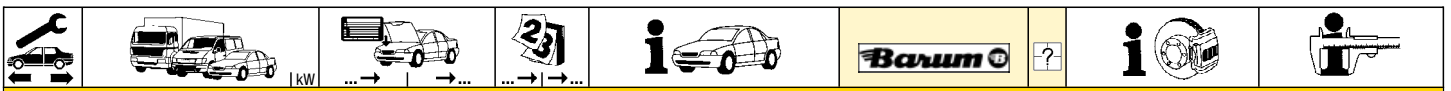

**VOLKSWAGEN TRANSPORTER (T5) (03-)**

	3.2 V6 3.2 V6 4motion	7J-8-000788 7J-8-000788	<b>02.03</b> <b>07.04</b>	PR: OWR,0E0,0E9 PR: OWR,0E0,0E9	<b>BA2327</b>	24367 19,1 +/WK	<b>ATE</b>	
	1.9 TDI 1.9 TDI 1.9 TDI 1.9 TDI 2.0 2.5 TDI 2.5 TDI 2.5 TDI 4motion 2.5 TDI 4motion 3.2 V6 3.2 V6 4motion	62 7J-8-000789 63 7J-8-000789 75 7J-8-000789 77 7J-8-000789 7J-8-000789 7J-8-000789 96 7J-8-000789 96 7J-8-000789 128 7J-8-000789 7J-8-000789 7J-8-000789	7J-8-030000 7J-8-030000 7J-8-030000 7J-8-030000 7J-8-030000 7J-8-030000 7J-8-030000 7J-8-030000 7J-8-030000 7J-8-030000 7J-8-030000	PR: OWR,0E0,0E9 PR: OWR,0E0,0E9 PR: OWR,0E0,0E9 PR: OWR,0E0,0E9 PR: OWR,0E0,0E9 PR: OWR,0E0,0E9 PR: OWR,0E0,0E9 PR: OWR,0E0,0E9 PR: OWR,0E0,0E9 PR: OWR,0E0,0E9 PR: OWR,0E0,0E9	<b>BA2243</b>	23326 17,4 /WK/S	<b>LUC</b>	
	1.9 TDI 1.9 TDI 1.9 TDI 1.9 TDI 2.0 2.0 BiTDI 2.0 BiTDI 4motion 2.0 TDI 2.0 TDI 2.0 TDI 2.0 TDI 4motion 2.5 TDI 2.5 TDI 2.5 TDI 4motion 2.5 TDI 4motion 3.2 V6 3.2 V6 4motion	62 7H-6-000001 63 7H-6-000001 75 7H-6-000001 77 7H-6-000001 7H-6-000001 132 7H-6-000001 132 7H-6-000001 62 7H-6-000001 75 7H-6-000001 103 7H-6-000001 103 7H-6-000001 7H-6-000001 96 7H-6-000001 96 7H-6-000001 128 7H-6-000001 7H-6-000001 7H-6-000001	7H-A-050000 7H-A-050000 7H-A-050000 7H-A-050000 7H-A-050000 7H-A-050000 7H-A-050000 7H-A-050000 7H-A-050000 7H-A-050000 7H-A-050000 7H-A-050000 7H-A-050000 7H-A-050000 7H-A-050000 7H-A-050000 7H-A-050000	PR: 2E3,2E4 PR: 2E3,2E4 PR: 2E3,2E4 PR: 2E3,2E4 PR: 2E3,2E4 PR: 2E3,2E4 PR: 2E3,2E4 PR: 2E3,2E4 PR: 2E3,2E4 PR: 2E3,2E4 PR: 2E3,2E4 PR: 2E3,2E4 PR: 2E3,2E4 PR: 2E3,2E4 PR: 2E3,2E4 PR: 2E3,2E4	<b>BA2243</b>	23326 17,4 /WK/S	<b>LUC</b>	
	1.9 TDI 1.9 TDI 1.9 TDI 1.9 TDI 2.0 2.5 TDI 2.5 TDI 2.5 TDI 4motion 2.5 TDI 4motion 3.2 V6 3.2 V6 4motion	62 63 75 77 7H-8-027999 96 96 128 7H-8-027999 7H-8-027999	<b>01.06</b> <b>04.03</b> <b>06.06</b> <b>04.03</b> <b>06.03</b> <b>02.03</b> <b>02.03</b> <b>07.04</b> <b>07.04</b> <b>02.03</b> <b>07.04</b>	PR: OWR PR: OWR PR: OWR PR: OWR PR: OWR PR: OWR PR: OWR PR: OWR PR: OWR PR: OWR PR: OWR	<b>BA2327</b>	24367 19,1 +/WK	<b>ATE</b>	
	1.9 TDI 1.9 TDI 1.9 TDI 1.9 TDI 2.0 2.5 TDI 2.5 TDI 2.5 TDI 4motion 2.5 TDI 4motion 3.2 V6 3.2 V6 4motion	62 7H-8-028000 63 7H-8-028000 75 7H-8-028000 77 7H-8-028000 7H-8-028000 96 7H-8-028000 96 7H-8-028000 128 7H-8-028000 7H-8-028000 7H-8-028000	7H-8-200000 7H-8-200000 7H-8-200000 7H-8-200000 7H-8-200000 7H-8-200000 7H-8-200000 7H-8-200000 7H-8-200000 7H-8-200000	PR: OWR PR: OWR PR: OWR PR: OWR PR: OWR PR: OWR PR: OWR PR: OWR PR: OWR PR: OWR	<b>BA2243</b>	23326 17,4 /WK/S	<b>LUC</b>	
	1.9 TDI 1.9 TDI 1.9 TDI 1.9 TDI 2.0 2.0 BiTDI 2.0 BiTDI 4motion 2.0 TDI 2.0 TDI 2.0 TDI 2.0 TDI 2.0 TDI 2.0 TDI 4motion 2.0 TDI 4motion 2.0 TSI 2.0 TSI 4motion 2.5 TDI 2.5 TDI 2.5 TDI 4motion 2.5 TDI 4motion 3.2 V6 3.2 V6 4motion	62 7H-A-200001 63 7H-A-200001 75 7H-A-200001 77 7H-A-200001 7H-A-200001 132 7H-A-200001 132 7H-A-200001 62 7H-A-200001 75 7H-A-200001 84 100 7H-A-200001 103 7H-A-200001 100 7H-A-200001 103 7H-A-200001 150 150 7H-A-200001 96 7H-A-200001 96 7H-A-200001 128 7H-A-200001 7H-A-200001 7H-A-200001	<b>05.11</b> <b>05.11</b> <b>07.11</b>			<b>BA2243</b>	23326 17,4 /WK/S	<b>LUC</b>
	1.9 TDI 1.9 TDI 1.9 TDI 1.9 TDI 2.0 2.0 BiTDI 2.0 BiTDI 4motion 2.0 TDI 2.0 TDI 2.0 TDI 2.0 TDI 2.0 TDI 2.0 TDI 4motion 2.0 TDI 4motion	62 7J-A-200001 63 7J-A-200001 75 7J-A-200001 77 7J-A-200001 7J-A-200001 132 7J-A-200001 132 7J-A-200001 62 7J-A-200001 75 7J-A-200001 100 7J-A-200001 103 7J-A-200001 100 7J-A-200001 103 7J-A-200001 100 7J-A-200001				<b>BA2243</b>	23326 17,4 /WK/S	<b>LUC</b>

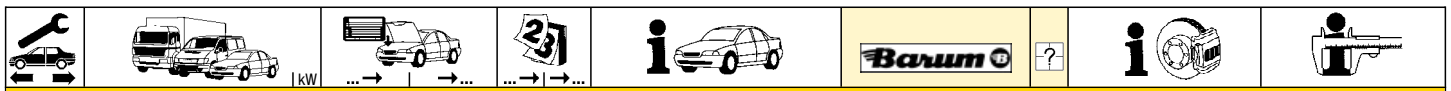

**VOLKSWAGEN TRANSPORTER (T5) (03-)**

	2.5 TDI 2.5 TDI 2.5 TDI 4motion 2.5 TDI 4motion 3.2 V6 3.2 V6 4motion	7J-A-200001 96 7J-A-200001 96 7J-A-200001 128 7J-A-200001 7J-A-200001 7J-A-200001				BA2243		23326 17,4 /WK/S	LUC	
	1.9 TDI 1.9 TDI 2.0 2.5 TDI 2.5 TDI 2.5 TDI 4motion 2.5 TDI 4motion 3.2 V6 3.2 V6 4motion	63 77  96 96 128	7H-5-120000 7H-5-120000 7H-5-120000 7H-5-120000 7H-5-120000 7H-5-120000 7H-5-120000 7H-5-120000 7H-5-120000	04.03 04.03 06.03 02.03 02.03 07.04 07.04 02.03 07.04	PR: OWL,OWN,OWM,OWP,OWQ PR: OWL,OWN,OWM,OWP,OWQ PR: OWL,OWN,OWM,OWP,OWQ PR: OWL,OWN,OWM,OWP,OWQ PR: OWL,OWN,OWM,OWP,OWQ PR: OWL,OWN,OWM,OWP,OWQ PR: OWL,OWN,OWM,OWP,OWQ PR: OWL,OWN,OWM,OWP,OWQ PR: OWL,OWN,OWM,OWP,OWQ	BAR22211		294 21,9 19,5 V L		
	1.9 TDI 1.9 TDI 1.9 TDI 1.9 TDI 2.0 2.0 BITDI 2.0 BITDI 4motion 2.0 TDI 2.0 TDI 2.0 TDI 2.0 TDI 4motion 2.5 TDI 2.5 TDI 2.5 TDI 4motion 2.5 TDI 4motion 3.2 V6 3.2 V6 4motion	62 63 75 77  132 132 62 75 103 103  96 96 128	7J-A-010000 7J-A-010000 7J-A-010000 7J-A-010000 7J-A-010000 7J-A-010000 7J-A-010000 7J-A-010000 7J-A-010000 7J-A-010000 7J-A-010000 7J-A-010000 7J-A-010000 7J-A-010000 7J-A-010000 7J-A-010000	01.06 04.03 06.06 04.03 06.03 09.09 09.09 09.09 09.09 09.09 09.09 02.03 02.03 07.04 07.04 02.03	PR: 2E3,2E4 PR: 2E3,2E4 PR: 2E3,2E4 PR: 2E3,2E4 PR: 2E3,2E4 PR: 2E3,2E4 PR: 2E3,2E4 PR: 2E3,2E4 PR: 2E3,2E4 PR: 2E3,2E4 PR: 2E3,2E4 PR: 2E3,2E4 PR: 2E3,2E4 PR: 2E3,2E4 PR: 2E3,2E4	BAR22211		294 21,9 19,5 V L		
	1.9 TDI 1.9 TDI 1.9 TDI 1.9 TDI 2.0 2.5 TDI 2.5 TDI 4motion 2.5 TDI 4motion 3.2 V6 3.2 V6 4motion	62 7J-8-000789 63 7J-8-000789 75 7J-8-000789 77 7J-8-000789  96 7J-8-000789 96 7J-8-000789 128 7J-8-000789 7J-8-000789 7J-8-000789	7J-8-030000 7J-8-030000 7J-8-030000 7J-8-030000 7J-8-030000 7J-8-030000 7J-8-030000 7J-8-030000 7J-8-030000 7J-8-030000		PR: OWR,0E0,0E9 PR: OWR,0E0,0E9 PR: OWR,0E0,0E9 PR: OWR,0E0,0E9 PR: OWR,0E0,0E9 PR: OWR,0E0,0E9 PR: OWR,0E0,0E9 PR: OWR,0E0,0E9 PR: OWR,0E0,0E9 PR: OWR,0E0,0E9	BAR22211		294 21,9 19,5 V L		
	1.9 TDI 1.9 TDI 1.9 TDI 1.9 TDI 2.0 2.0 BITDI 2.0 BITDI 4motion 2.0 TDI 2.0 TDI 2.0 TDI 2.0 TDI 4motion 2.5 TDI 2.5 TDI 2.5 TDI 4motion 2.5 TDI 4motion 3.2 V6 3.2 V6 4motion	62 7H-6-000001 63 7H-6-000001 75 7H-6-000001 77 7H-6-000001  132 7H-6-000001 132 7H-6-000001 62 7H-6-000001 75 7H-6-000001 103 7H-6-000001 103 7H-6-000001  96 7H-6-000001 96 7H-6-000001 128 7H-6-000001 7H-6-000001 7H-6-000001	7H-A-050000 7H-A-050000 7H-A-050000 7H-A-050000 7H-A-050000 7H-A-050000 7H-A-050000 7H-A-050000 7H-A-050000 7H-A-050000 7H-A-050000 7H-A-050000 7H-A-050000 7H-A-050000 7H-A-050000 7H-A-050000		PR: 2E3,2E4 PR: 2E3,2E4 PR: 2E3,2E4 PR: 2E3,2E4 PR: 2E3,2E4 PR: 2E3,2E4 PR: 2E3,2E4 PR: 2E3,2E4 PR: 2E3,2E4 PR: 2E3,2E4 PR: 2E3,2E4 PR: 2E3,2E4 PR: 2E3,2E4 PR: 2E3,2E4 PR: 2E3,2E4	BAR22211		294 21,9 19,5 V L		
	1.9 TDI 1.9 TDI 1.9 TDI 1.9 TDI 2.0 2.5 TDI 2.5 TDI 2.5 TDI 4motion 2.5 TDI 4motion 3.2 V6 3.2 V6 4motion	62 7H-8-028000 63 7H-8-028000 75 7H-8-028000 77 7H-8-028000  96 7H-8-028000 96 7H-8-028000 128 7H-8-028000 7H-8-028000 7H-8-028000	7H-8-200000 7H-8-200000 7H-8-200000 7H-8-200000 7H-8-200000 7H-8-200000 7H-8-200000 7H-8-200000 7H-8-200000 7H-8-200000		PR: OWR PR: OWR PR: OWR PR: OWR PR: OWR PR: OWR PR: OWR PR: OWR PR: OWR	BAR22211		294 21,9 19,5 V L		
	1.9 TDI 1.9 TDI 1.9 TDI 1.9 TDI 2.0 2.0 BITDI 2.0 BITDI 4motion 2.0 TDI 2.0 TDI 2.0 TDI 2.0 TDI 4motion 2.0 TDI 4motion 2.0 TDI 4motion 2.0 TSI 2.0 TSI 4motion	62 7H-A-200001 63 7H-A-200001 75 7H-A-200001 77 7H-A-200001  132 7H-A-200001 132 7H-A-200001 62 7H-A-200001 75 7H-A-200001 84 100 7H-A-200001 103 7H-A-200001 100 7H-A-200001 103 7H-A-200001 150 150			05.11		BAR22211		294 21,9 19,5 V L	
↓										























**VOLKSWAGEN TRANSPORTER (T5) (03-)**

	2.5 TDI	7H-A-200001				BAR22211		294 21,9 19,5 V L
	2.5 TDI	96 7H-A-200001						
	2.5 TDI 4motion	96 7H-A-200001						
	2.5 TDI 4motion	128 7H-A-200001						
	3.2 V6	7H-A-200001						
	3.2 V6 4motion	7H-A-200001						
	1.9 TDI	62 7J-A-200001				BAR22211		294 21,9 19,5 V L
	1.9 TDI	63 7J-A-200001						
	1.9 TDI	75 7J-A-200001						
	1.9 TDI	77 7J-A-200001						
	2.0	7J-A-200001						
	2.0 BiTDI	132 7J-A-200001						
	2.0 BiTDI 4motion	132 7J-A-200001						
	2.0 TDI	62 7J-A-200001						
	2.0 TDI	75 7J-A-200001						
	2.0 TDI	100 7J-A-200001						
	2.0 TDI	103 7J-A-200001						
	2.0 TDI 4motion	100 7J-A-200001						
	2.0 TDI 4motion	103 7J-A-200001						
	2.5 TDI	7J-A-200001						
	2.5 TDI	96 7J-A-200001						
	2.5 TDI 4motion	96 7J-A-200001						
	2.5 TDI 4motion	128 7J-A-200001						
	3.2 V6	7J-A-200001						
	3.2 V6 4motion	7J-A-200001						

**VOLKSWAGEN VENTO (92-98)**

	1.4		1H-T-015953	11.91			BA2132		20887 19,7 +/Zub	VW	
	1.6	55	1H-T-015953	09.92		+ Schaltgetriebe <sup>1)</sup>					
	1.6	55	1H-S-430000	09.92		+ Automatikgetriebe <sup>2)</sup>					
	1.8	55	1H-T-015953	01.92		+ Schaltgetriebe <sup>1)</sup>					
	1.8 CL/GL	66	1H-S-430000	01.92							
	1.9 D		1H-T-015953	11.91							
	1.9 TD	55	1H-S-430000	01.92							
	1.4		1H-T-015954		09.98	- ABS		BA2145		21866 19,7 +	VW
	1.6	55	1H-T-015954		09.98	+ Schaltgetriebe <sup>1)</sup>					
	1.8	55	1H-T-015954		09.98	+ Schaltgetriebe <sup>1)</sup>					
1.9 D		1H-T-015954		09.98	- ABS						
1.9 SDI			04.97	09.98	- ABS						
1.6	55	1H-S-430001		09.98	+ Automatikgetriebe <sup>2)</sup>		BA2038		20168 19,6 /S	LUC	
1.6 CL/GL	74		07.94	09.98							
1.8	55		01.92	09.98	+ Automatikgetriebe <sup>2)</sup>						
1.8 CL/GL	66	1H-S-430001		09.98							
1.9 TD	55	1H-S-430001		09.98							
1.9 TDI	66		07.93	09.98	- ABS						
1.4			05.96	09.96	+ ABS		BA2018		21945 16,3 /S	LUC	
1.6 GT	74		07.94	09.98							
1.8 GT	66		01.92	09.98							
1.9 D			05.96	09.96	+ ABS						
1.9 TDI	66		07.93	09.98							
1.9 TDI	81		02.96	09.98	+ ABS						
2.0 CL/GL			11.91	09.98							
1.4			10.96	09.98	+ ABS		BA2153		21866 15,3 +	VW	
1.9 D			10.96	09.98	+ ABS						
1.9 SDI			04.97	09.98	+ ABS						
2.0 GT		1H-S-560001		04.96			BA2038		20168 19,6 /S	LUC	
2.0 GT			05.96	09.98			BA2333		21911 20,3 +	ATE	
2.8 VR6		1H-S-560001		09.98							
	1.4			11.91	09.98	- ABS		BAR12106		239 12,0 10,0	
	1.6	55	1H-S-430000	09.92	09.98	+ Automatikgetriebe <sup>2)</sup>					
	1.6	55		09.92	09.98	+ Schaltgetriebe <sup>1)</sup>					
	1.8	55		01.92	09.98	+ Schaltgetriebe <sup>1)</sup>					
	1.8 CL/GL	66	1H-S-430000	01.92	09.98						
	1.9 D			11.91	09.98	- ABS					
	1.9 SDI			04.97	09.98	- ABS					
	1.9 TD	55	1H-S-430000	11.91	09.98						
	1.6	55	1H-S-430001		09.98	+ Automatikgetriebe <sup>2)</sup>		BAR13178		256 12,9 11,0	
	1.6 CL/GL	74		07.94	09.98						
	1.8	55		01.92	09.98	+ Automatikgetriebe <sup>2)</sup>					
	1.8 CL/GL	66	1H-S-430001		09.98						
	1.9 TD	55	1H-S-430001		09.98						
	1.9 TDI	66		07.93	09.98	- ABS					
	1.4			05.96	09.96	+ ABS		BAR20128		256 20,0 18,0 V L	
	1.6 GT	74		07.94	09.98						
	1.8 GT	66		01.92	09.98						
	1.9 D			05.96	09.96	+ ABS					
	1.9 TDI	66		07.93	09.98	+ ABS					
	1.9 TDI	81		02.96	09.98						
2.0 CL/GL			11.91	09.98							
1.4			10.96	09.98	+ ABS		BAR20123		239 20,0 18,0 V L		
1.9 D			10.96	09.98	+ ABS						
1.9 SDI			04.97	09.98	+ ABS						
2.0 GT			11.91	04.96			BAR22100		280 22,0 20,0 V L		
2.8 VR6		1H-S-560000	01.92								

<sup>1)</sup> + manual transmission / + scatola cambio velocità / + transmission mécanique / + cambio de velocidad  
<sup>2)</sup> + autom.transmission / + scatola cambio automatico / + transmission automatique / + cambio automático

								
<b>VOLKSWAGEN VENTO (92-98)</b>								
	1.4 1.6 1.8 1.9 D 1.9 SDI 1.9 TD 1.9 TDI 1.9 TDI 2.0 2.8 VR6			11.91 09.98 09.92 09.98 01.92 09.98 11.91 09.98 04.97 09.98 11.91 09.98 07.93 09.98 02.96 09.98 11.91 09.98 1H-S-560000 01.92		BAH0005	2	L=435
	1.6 GT 1.8 GT 1.9 GT TDI 2.0 2.0 GT 2.8 VR6	74 66		07.94 09.98 01.92 09.98 07.93 09.98 11.91 09.98 1H-P-240000 11.91 1H-P-240000 01.92		BA2032		20961 15,2/S LUC
	1.9 TDI 2.0 GT 2.8 VR6	81	1H-P-240001 1H-P-240001	02.96 09.98 09.98 09.98 09.98 09.98		BA2017		20961 17,2/S LUC
	1.6 1.8 GT 1.9 GT TDI 1.9 TDI 2.0 CL/GL 2.0 GT 2.8 VR6	74 66 81		07.94 09.98 01.92 09.98 07.93 09.98 02.96 09.98 11.91 09.98 11.91 09.98 01.92 09.98		BAR10111	für 4-Loch-Felge/- Sensorring <sup>1)</sup>	226 10,0 8,0
	2.0 GT 2.8 VR6			11.91 09.98 01.92 09.98		BAR10203		226 10,0 8,0
	1.4 1.6 1.8 1.9 D 1.9 SDI 1.9 TD 1.9 TDI	55 66		11.91 09.98 09.92 09.98 01.92 09.98 - GT 11.91 09.98 04.97 09.98 11.91 09.98 07.93 09.98 - GT		BAH0016	2	L=135
	1.6 GT 1.8 GT 1.9 GT TDI 1.9 TDI 2.0 2.8 VR6	74 66 81		07.94 09.98 01.92 09.98 07.93 09.98 02.96 09.98 11.91 09.98 01.92 09.98		BAH0016 BAH0003	2 2	am Bremsattel <sup>2)</sup> L=135 L=160
	1.4 1.6 1.8 1.8 CL/GL 1.9 D 1.9 SDI 1.9 TD	55 55 55 66	1H-S-430000 1H-S-430000	11.91 09.98 09.92 09.98 01.92 09.98 01.92 09.98 11.91 09.98 04.97 09.98 11.91 09.98		BAW1701	+ GG <sup>3)</sup>	Rz 17,46
	1.6 1.6 CL/GL 1.8 1.8 CL/GL 1.9 TD 1.9 TDI	55 74 55 66 55 66	1H-S-430001 1H-S-430001 1H-S-430001	09.98 09.98 07.94 09.98 01.92 09.98 09.98 09.98 09.98 09.98 07.93 09.98 - GT		BAW1905		Rz 19,05
	1.4 1.6 1.8 1.9 D 1.9 SDI 1.9 TD 1.9 TDI	55 55		11.91 09.98 09.92 09.98 01.92 09.98 - GT 11.91 09.98 04.97 09.98 11.91 09.98 07.93 09.98 - GT		BAE5001		200 x 40 HEB VW
<b>VOLKSWAGEN up (11-)</b>								
	1.0 1.0	44 55		12.11 12.11	PR: 1LA,1ZQ PR: 1LA,1ZQ	BA2154		23130 19,6 + VW
	1.0 1.0	44 55		12.11 12.11		BAW1701	2	Rz 17,46
	1.0 1.0	44 55		12.11 12.11		BAE5001		200 x 40 HEB VW
<b>VOLVO 440 (88-96)</b>								
	1.6 1.7 1.7 1.7 1.7 1.8 1.9 TD 2.0	61 EKC 006387 64 EKC 006387 70 EKC 006387 75 EKC 006387 78 EKC 006387 66 66 80 EKC 006387		12.96 12.96 07.89 12.96 12.96 12.96 12.96 12.96 08.91 12.96 07.94 12.96 07.96		BA2014		21217 17,5/S LUC

<sup>1)</sup> for 4-hole rim/-sensor ring / per cerch.4 fori/-sensore ruota / pour jante 4 trous/-roue codeuse / para llanta cuatro agujeros/-anillo sensor

<sup>2)</sup> on the brake caliper / sulla pinza freno / sur l'étrier de frein / a la pinza de freno

<sup>3)</sup> + cast iron / + ghisa / + fonte grise / + fundición de gris

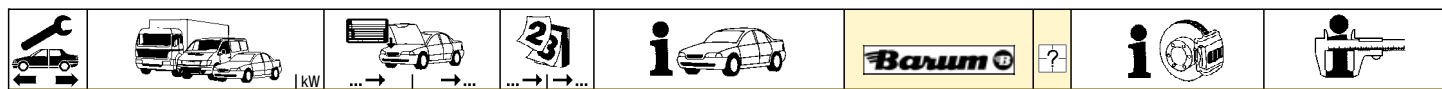

**VOLVO 460 (88-96)**

	1.6	61		07.92	07.96	BA2014		21217 17,5 /S	LUC
	1.7	64 EKC 006387			07.96				
	1.7	66 EKC 006387			07.96				
	1.7	75 EKC 006387			07.92				
	1.7	80 EKC 006387			07.92				
	1.8	66		08.91	07.96				
	1.9 TD	66		07.94	07.96				
	2.0	80 EKC 006387			07.96				
	2.0	81		08.92	07.95				

**VOLVO 480 (86-96)**

	1.7	70 EKC 538520		08.89	07.89	BA2014		21217 17,5 /S	LUC
	1.7	75			07.96				
	1.7	78 EKC 538520			07.89				

**VOLVO 850 Limousine (91-96)**

















	2.0	93		08.94	12.96	BA2244		21273 19,5 +/WE	ATE
	2.0	105		06.91	12.96				
	2.0 T	155		08.93	12.96				
	2.5	103		06.91	07.94				
	2.5	106		08.94	12.96				
	2.5	125		08.91	12.96				
	2.5 TDI	103		08.95	12.96				
	2.3 T5	166		08.93	07.96	BA2244		21273 19,5 +/WE	ATE
	2.3 T5 R	184		08.95	12.96				
	2.0	93		08.94	12.96	BAR26102		280 26,0 23,0 V	
	2.0	105		06.91	12.96				
	2.0 T	155		08.93	12.96				
	2.3 T5	166		08.93	07.96				
	2.3 T5 R	184		08.95	12.96				
	2.5	103		09.93	07.94				
	2.5	106		08.94	12.96				
	2.5	125		09.93	12.96				
	2.5 TDI	103		08.95	12.96				

**VOLVO 850 Kombi (92-96)**

























	2.0	93		08.94	12.96	BA2244		21273 19,5 +/WE	ATE
	2.0	105		02.93	12.96				
	2.0 T	155		02.93	12.96				
	2.5	103		08.92	07.94				
	2.5	106		08.94	12.96				
	2.5	125		09.92	12.96				
	2.5 AWD	142		04.96	12.96				
	2.5 TDI	103		08.95	12.96				
	2.3 T5	166		02.93	12.96	BA2244		21273 19,5 +/WE	ATE
	2.3 T5 R	184		08.95	12.96				
	2.0	93		08.94	12.96	BAR26102		280 26,0 23,0 V	
	2.0	105		02.93	12.96				
	2.0 T	155		02.93	12.96				
	2.3 T5	166		02.93	12.96				
	2.3 T5 R	184		08.95	12.96				
	2.5	103		09.93	07.94				
	2.5	106		08.94	12.96				
	2.5	125		08.93	12.96				
	2.5 AWD	142		04.96	12.96				
	2.5 TDI	103		08.95	12.96				

**VOLVO 940 I Limousine (90-95)**

	2.0 T	114		01.91	12.91	BA2181	+ ABS	20164 18,2	LUC
	2.3	96		08.90	12.91				
	2.3	114		08.90	07.91				
	2.3 T	121		08.90	12.91				
	2.3 T	140		08.91	12.91				
	2.4 D	60		08.90	12.91				
	2.4 TD	80		08.90	12.91				
	2.4 TD Intercooler	90		08.90	12.91				
	2.0	82		01.92	07.94	BA2181		20164 18,2	LUC
	2.0 T	114		01.92	07.95				
	2.3			08.92	07.94				
	2.3	96		01.92	12.94				
	2.3 T	121		01.92	07.94				
	2.3 T	140		01.92	07.93				
	2.4 D	60		01.92	12.94				
	2.4 TD	80		01.92	12.94				
	2.4 TD Intercooler	90		01.92	12.94				
	2.0 T	114		01.91	12.91	BAR26105	+ ABS	280 26,0 23,0 V	
	2.3	96		08.90	12.91				
	2.3	114		08.90	07.91				
	2.3 T	121		08.90	12.91				
	2.3 T	140		08.91	12.91				
	2.4 D	60		08.90	12.91				
	2.4 TD	80		08.90	12.91				
	2.4 TD Intercooler	90		08.90	12.91				
	2.0	82		01.92	07.94	BAR26105		280 26,0 23,0 V	
	2.0 T	114		01.92	07.95				
	2.3			08.92	07.94				

















										
<b>VOLVO 940 I Limousine (90-95)</b>										
	2.3	96		01.92	12.94		BAR26105	280 26,0 23,0 V		
	2.3 T	121		01.92	07.94					
	2.3 T	140		01.92	07.93					
	2.4 D	60		01.92	12.94					
	2.4 TD	80		01.92	12.94					
	2.4 TD Intercooler	90		01.92	12.94					
	2.0	82		01.92	07.94	- Multi-Link-Achse <sup>1)</sup>	BAR10189	281 9,6 8,4		
	2.0 T	114		01.91	07.95	- Multi-Link-Achse <sup>1)</sup>				
	2.3			08.92	07.94	- Multi-Link-Achse <sup>1)</sup>				
	2.3	96		08.90	12.94	- Multi-Link-Achse <sup>1)</sup>				
	2.3	114		08.90	07.91	- Multi-Link-Achse <sup>1)</sup>				
	2.3 T	121		08.90	07.94	- Multi-Link-Achse <sup>1)</sup>				
	2.3 T	140		08.91	07.93	- Multi-Link-Achse <sup>1)</sup>				
	2.4 D	60		08.90	12.94	- Multi-Link-Achse <sup>1)</sup>				
	2.4 TD	80		08.90	12.94	- Multi-Link-Achse <sup>1)</sup>				
	2.4 TD Intercooler	90		08.90	12.94	- Multi-Link-Achse <sup>1)</sup>				
<b>VOLVO 940 I Kombi (90-95)</b>										
	2.0 T	114		01.91	12.91		BA2181	+ ABS	20164 18,2	LUC
	2.3	96		08.90	12.91					
	2.3	114		08.90	07.91					
	2.3 T	121		08.90	12.91					
	2.3 T	140		08.91	12.91					
	2.4 D	60		08.90	12.91					
	2.4 TD	80		08.90	12.91					
	2.4 TD Intercooler	90		08.90	12.91					
	2.0	82		01.92	07.94		BA2181	+ ABS	20164 18,2	LUC
	2.0 T	114		01.92	07.95					
	2.3	85		08.92	07.94					
	2.3	96		01.92	07.94					
	2.3 T	121		01.92	07.94					
	2.3 T	140		01.92	07.93					
	2.4 D	60		01.92	07.95					
	2.4 TD	80		01.92	07.94					
	2.4 TD Intercooler	90		01.92	07.94					
	2.0	82		01.92	12.92		BAR26105	+ ABS	280 26,0 23,0 V	
	2.0 T	114		01.91	12.91					
	2.3	96		08.90	12.91					
	2.3	114		08.90	07.91					
	2.3 T	121		08.90	12.91					
	2.3 T	140		08.91	12.91					
	2.4 D	60		08.90	12.91					
	2.4 TD	80		08.90	12.91					
	2.4 TD Intercooler	90		08.90	12.91					
	2.0	82		01.93	07.94		BAR26105	+ ABS	280 26,0 23,0 V	
	2.0 T	114		01.92	07.95					
	2.3	85		08.92	07.94					
	2.3	96		01.92	07.94					
	2.3 T	121		01.92	07.94					
	2.3 T	140		01.92	07.93					
	2.4 D	60		01.92	07.95					
	2.4 TD	80		01.92	07.94					
	2.4 TD Intercooler	90		01.92	07.94					
	2.0	82		01.92	07.94	- Multi-Link-Achse <sup>1)</sup>	BAR10189		281 9,6 8,4	
	2.0 T	114		01.91	07.95	- Multi-Link-Achse <sup>1)</sup>				
	2.3	85		08.92	07.94	- Multi-Link-Achse <sup>1)</sup>				
	2.3	96		08.90	07.94	- Multi-Link-Achse <sup>1)</sup>				
	2.3	114		08.90	07.91	- Multi-Link-Achse <sup>1)</sup>				
	2.3 T	121		08.90	07.94	- Multi-Link-Achse <sup>1)</sup>				
	2.3 T	140		08.91	07.93	- Multi-Link-Achse <sup>1)</sup>				
	2.4 D	60		08.90	07.95	- Multi-Link-Achse <sup>1)</sup>				
	2.4 TD	80		08.90	07.94	- Multi-Link-Achse <sup>1)</sup>				
	2.4 TD Intercooler	90		08.90	07.94	- Multi-Link-Achse <sup>1)</sup>				
<b>VOLVO 940 II Limousine (95-98)</b>										
	2.0 T	114		04.96	10.98		BA2181		20164 18,2	LUC
	2.3	85		08.94	07.95					
	2.3	96		08.94	10.98					
	2.3 T	121		08.94	10.98					
	2.3 ti	99		01.95	10.98					
	2.4 TD Intercooler	90		08.94	10.98					
	2.0 T	114		04.96	10.98		BAR26105		280 26,0 23,0 V	
	2.3	85		08.94	07.95					
	2.3	96		08.94	10.98					
	2.3 T	121		08.94	10.98					
	2.3 ti	99		01.95	10.98					
	2.4 TD Intercooler	90		08.94	10.98					
	2.0 T	114		04.96	10.98	- Multi-Link-Achse <sup>1)</sup>	BAR10189		281 9,6 8,4	
	2.3	85		08.94	07.95	- Multi-Link-Achse <sup>1)</sup>				
	2.3	96		08.94	10.98	- Multi-Link-Achse <sup>1)</sup>				
	2.3 T	121		08.94	10.98	- Multi-Link-Achse <sup>1)</sup>				
	2.3 ti	99		01.95	10.98	- Multi-Link-Achse <sup>1)</sup>				
	2.4 TD Intercooler	90		08.94	10.98	- Multi-Link-Achse <sup>1)</sup>				

<sup>1)</sup> - multi link axle / - assale Multi-link / - essieu multi-link / - eje Multi-Link

								
<b>VOLVO 940 II Kombi (95-98)</b>								
	2.0 T 2.3 2.3 2.3 T 2.3 T 2.3 ti 2.4 TD Intercooler	114 85 96 121 126 99 90		04.96 08.94 08.94 08.94 08.95 01.95 08.94	10.98 07.95 10.98 10.98 10.98 10.98 10.98	BA2181		20164 18,2 LUC
	2.0 T 2.3 2.3 2.3 T 2.3 T 2.3 ti 2.4 TD Intercooler	114 85 96 121 126 99 90		04.96 08.94 08.94 08.94 08.95 01.95 08.94	10.98 07.95 10.98 10.98 10.98 10.98 10.98	BAR26105		280 26,0 23,0 V
	2.0 T 2.3 2.3 2.3 T 2.3 T 2.3 ti 2.4 TD Intercooler	114 85 96 121 126 99 90		04.96 08.94 08.94 08.94 08.95 01.95 08.94	10.98 07.95 10.98 10.98 10.98 10.98 10.98	BAR10189	- Multi-Link-Achse <sup>1)</sup> - Multi-Link-Achse <sup>1)</sup> - Multi-Link-Achse <sup>1)</sup> - Multi-Link-Achse <sup>1)</sup> - Multi-Link-Achse <sup>1)</sup> - Multi-Link-Achse <sup>1)</sup> - Multi-Link-Achse <sup>1)</sup>	281 9,6 8,4
<b>VOLVO 960 I Limousine (90-94)</b>								
	2.0 2.0 2.4 TD Intercooler 2.9	103 140 85 150		09.90 08.90 09.91 08.90	08.93 09.93 07.94 07.94	BA2181		20164 18,2 LUC
	2.0 2.0 2.4 TD Intercooler 2.9	103 140 85 150		09.90 08.90 09.91 08.90	08.93 09.93 07.94 07.94	BAR26105		280 26,0 23,0 V
	2.0 2.0 2.4 TD Intercooler 2.9	103 140 85 150		09.90 08.90 09.91 08.90	08.93 09.93 07.94 07.94	BAR10189	- Multi-Link-Achse <sup>1)</sup> - Multi-Link-Achse <sup>1)</sup> - Multi-Link-Achse <sup>1)</sup> - Multi-Link-Achse <sup>1)</sup>	281 9,6 8,4
<b>VOLVO 960 I Kombi (90-94)</b>								
	2.0 2.0 2.4 TD Intercooler 2.8 2.8 2.9	103 140 85 108 115 150		09.90 08.90 09.91 09.90 09.90 08.90	08.93 09.93 07.94 05.92 05.92 07.94	BA2181		20164 18,2 LUC
	2.0 2.0 2.4 TD Intercooler 2.8 2.8 2.9	103 140 85 108 115 150		09.90 08.90 09.91 09.90 09.90 08.90	08.93 09.93 07.94 05.92 05.92 07.94	BAR26105		280 26,0 23,0 V
	2.0 2.0 2.4 TD Intercooler 2.8 2.8 2.9	103 140 85 108 115 150		09.90 08.90 09.91 09.90 09.90 08.90	08.93 09.93 07.94 05.92 05.92 07.94	BAR10189	- Multi-Link-Achse <sup>1)</sup> - Multi-Link-Achse <sup>1)</sup> - Multi-Link-Achse <sup>1)</sup> - Multi-Link-Achse <sup>1)</sup> - Multi-Link-Achse <sup>1)</sup> - Multi-Link-Achse <sup>1)</sup>	281 9,6 8,4
<b>VOLVO 960 II Limousine (94-96)</b>								
	2.5 2.9	125 150		08.94 08.94	12.96 12.96	BA2181		20164 18,2 LUC
	2.5 2.9 2.9	125 150 150		08.94 01.95 08.94	12.96 12.96 12.94	BAR26102 BAR26105		280 26,0 23,0 V 280 26,0 23,0 V
	2.5 2.9	125 150		08.94 08.94	12.96 12.96	BAR10189	- Multi-Link-Achse <sup>1)</sup> - Multi-Link-Achse <sup>1)</sup>	281 9,6 8,4
<b>VOLVO 960 II Kombi (94-96)</b>								
	2.5 2.9	125 150		08.94 08.94	12.96 12.96	BA2181		20164 18,2 LUC
	2.5 2.9 2.9	125 150 150		08.94 01.95 08.94	12.96 12.96 12.94	BAR26102 BAR26105		280 26,0 23,0 V 280 26,0 23,0 V
	2.5 2.9	125 150		08.94 08.94	12.96 12.96	BAR10189	- Multi-Link-Achse <sup>1)</sup> - Multi-Link-Achse <sup>1)</sup>	281 9,6 8,4
<b>VOLVO C30 Coupe (06-)</b>								
	1.6 1.6 D 1.6 D Efficiency 1.6 D2 1.8 1.8 FlexiFuel	74 80 77 84 92 92		09.06 09.06 09.08 10.10 09.06 04.07		BA2234	+ 15"/16" Rad <sup>2)</sup>	23723 18,4+ ATE

<sup>1)</sup> - multi link axle / - assale Multi-link / - essieu multi-link / - eje Multi-Link

<sup>2)</sup> + 15"/16" wheel / + ruota 15"/16" / + roue 15"/16" / + rueda 15"/16"







									
<b>VOLVO C30 Coupe (06-)</b>									
	2.0	107		09.06		BA2234	+ 15"/16" Rad <sup>1)</sup>	23723 18,4 +	ATE
	2.0 D	100		09.06					
	2.0 D3	110		10.10					
	2.0 D4	130		10.10					
	2.4 D5	120		10.06					
	2.4 D5	132		09.06					
	2.4 i	125		09.06					
	2.5 T5	162		09.06					
	2.5 T5	169		03.07					
	1.6	74		09.06		BAR25162	+ 16" Rad <sup>2)</sup>	300 25,0 23,0 V L	
	1.6 D	80		09.06					
	1.6 D Efficiency	77		09.08					
	1.6 D2	84		10.10					
	1.8	92		09.06					
	1.8 FlexiFuel	92		04.07					
	2.0	107		09.06					
	2.0 D	100		09.06					
	2.0 D3	110		10.10					
	2.0 D4	130		10.10					
	2.4 D5	120		10.06					
	2.4 D5	132		09.06					
	2.4 i	125		09.06					
	2.5 T5	162		09.06					
	2.5 T5	169		03.07					
	1.6	74		09.06		BA2258		23482 16,4 +	ATE
	1.6 D	80		09.06					
	1.6 D Efficiency	77		09.08					
	1.6 D2	84		10.10					
	1.8	92		09.06					
	1.8 FlexiFuel	92		04.07					
	2.0	107		09.06					
	2.0 D	100		09.06					
	2.0 D3	110		10.10					
	2.0 D4	130		10.10					
	2.4 D5	120		10.06					
	2.4 D5	132		09.06					
	2.4 i	125		09.06					
	2.5 T5	162		09.06					
	2.5 T5	169		03.07					
<b>VOLVO C70 Coupe (97-02)</b>									
	2.0	132		03.97	12.98	BA2234	+ 15"/16" Rad <sup>1)</sup>	23723 18,4 +	ATE
	2.0 T	166		03.97	12.98				
	2.5 T	142		03.97	12.98				
	2.3 T5	176		03.97	12.98	BA2234	+ 15"/16" Rad <sup>1)</sup>	23723 18,4 +	ATE
	2.0	132		01.99		BA2244	+ 15"/16" Rad <sup>1)</sup>	21273 19,5 +/-WE	ATE
	2.0 T	120		03.00					
	2.0 T	166		01.99					
	2.5	121		09.99					
	2.5	125		11.99					
	2.5 T	142		01.99					
	2.3 T5	176		01.99		BA2244	+ 15"/16" Rad <sup>1)</sup>	21273 19,5 +/-WE	ATE
	2.0	132		03.97	09.02	BAR26102	+ 15" Rad <sup>3)</sup>	280 26,0 23,0 V	
	2.0 T	120		03.00	09.02				
	2.0 T	166		03.97	09.02				
	2.3 T5	176		03.97	09.02				
	2.5	121		03.99	09.02				
	2.5	125		11.99	09.02				
	2.5 T	142		03.97	09.02				
	2.0	132		03.97	09.02	BA2162		21035 15,5	ATE
	2.0 T	120		03.00	09.02				
	2.0 T	166		03.97	09.02				
	2.3 T5	176		03.97	09.02				
	2.5	121		03.99	09.02				
	2.5	125		11.99	09.02				
	2.5 T	142		03.97	09.02				
<b>VOLVO C70 I Cabrio (98-06)</b>									
	2.0	132		03.98	02.06	BA2244		21273 19,5 +/-WE	ATE
	2.0 T	120		03.00	02.06				
	2.4 T	147		07.02	02.06				
	2.5	125		06.98	02.06				
	2.5 T	142		03.98	02.06				
	2.0 T	166		03.98	02.06	BA2244		21273 19,5 +/-WE	ATE
	2.3 T5	176		03.98	02.06				
	2.3 T5	180		07.02	02.06				
	2.0	132		03.98	02.06	BAR26102	+ 15" Rad <sup>3)</sup>	280 26,0 23,0 V	
	2.0 T	120		03.00	02.06				
	2.0 T	166		03.98	02.06				
	2.3 T5	176		03.98	02.06				
	2.3 T5	180		07.02	02.06				
	2.4 T	147		07.02	02.06				
	2.5	125		06.98	02.06				
	2.5 T	142		03.98	02.06				

<sup>1)</sup> + 15"/16" wheel / + ruota 15"/16" / + roue 15"/16" / + rueda 15"/16"

<sup>2)</sup> + 16" wheel / + ruota 16" / + roue 16" / + rueda 16"

<sup>3)</sup> + 15" wheel / + ruota 15" / + roue 15" / + rueda 15"



VOLVO C70 I Cabrio (98-06)													
	2.0	132	03.98	02.06		BA2162				21035	15,5	ATE	
	2.0 T	120	03.00	02.06									
	2.0 T	166	03.98	02.06									
	2.3 T5	176	03.98	02.06									
	2.3 T5	180	07.02	02.06									
	2.4 T	147	07.02	02.06									
	2.5	125	06.98	02.06									
	2.5 T	142	03.98	02.06									
VOLVO C70 II Cabrio (06-)													
	2.0 D	100	06.08		- (USA) ↘	BA2234		- 17" Rad <sup>1)</sup>		23723	18,4 +	ATE	
	2.0 D3	110	10.10										
	2.0 D4	130	10.10										
	2.4	103	03.06		- (USA) ↘								
	2.4 D5	132	03.06		- (USA) ↘								
	2.4 i	125	03.06		- (USA) ↘								
	2.5 T5	162	03.06		- (USA) ↘								
	2.5 T5	169	03.07		- (USA) ↘								
	2.0 D3	110	10.10			BAR25162		+ 16" Rad <sup>2)</sup>		300	25,0 23,0 V L		
	2.0 D4	130	10.10										
	2.4	103	03.06										
	2.4 D5	132	03.06										
	2.4 i	125	03.06										
	2.5 T5	162	03.06										
	2.5 T5	169	03.07										
	2.0 D	100	06.08			BA2258				23482	16,4 +	ATE	
	2.0 D3	110	10.10										
	2.0 D4	130	10.10										
	2.4	103	03.06										
	2.4 D5	132	03.06										
	2.4 i	125	03.06										
	2.5 T5	162	03.06										
	2.5 T5	169	03.07										
VOLVO S40 I (95-03)													
	1.6	77	09.95	08.97		BA2268				21920	15,1 /WK/S	LUC	
	1.8 (1731)	85	07.95	08.97									
	1.9 T4	147	05.97	08.97									
	1.9 TD	66	07.95	08.97									
	2.0	100	07.95	08.97									
	2.0	103	07.95	08.97									
	1.6	77	09.97	08.99		BA2237				21983	17,3 /WK/Zub	LUC	
	1.6	80	03.99	12.03									
	1.8 (1731)	85	09.97	08.99									
	1.8 (1783)	90	03.99	12.03									
	1.8 i (1834)	90	06.01	12.03									
	1.8 i (1834)	92	03.98	12.03									
	1.9 DI	70	03.99	07.00									
	1.9 DI	75	07.00	12.03									
	1.9 DI	85	07.00	12.03									
	1.9 T4	147	09.97	07.00									
	1.9 TD	66	09.97	08.99									
	2.0	100	09.97	12.03									
	2.0	103	09.97	08.99									
	2.0 T	118	10.97	07.00									
	2.0 T	120	06.01	12.03									
	2.0 T	121	07.00	06.01									
	2.0 T4	147	07.00	12.03									
	1.6	77	09.95	08.97		BAR24136				256	24,0 21,5 V		
	1.8 (1731)	85	07.95	08.97									
	1.9 T4	147	05.97	08.97									
	1.9 TD	66	07.95	08.97									
	2.0	100	07.95	08.97									
	2.0	103	07.95	08.97									
	1.6	77	09.97	08.99		BAR24159				281	24,0 21,5 V		
	1.6	80	03.99	12.03									
	1.8 (1731)	85	09.97	08.99									
	1.8 (1783)	90	03.99	12.03									
	1.8 i (1834)	90	06.01	12.03									
	1.8 i (1834)	92	03.98	12.03									
	1.9 DI	70	03.99	07.00									
	1.9 DI	75	07.00	12.03									
	1.9 DI	85	07.00	12.03									
	1.9 T4	147	09.97	07.00									
	1.9 TD	66	09.97	08.99									
	2.0	100	09.97	12.03									
	2.0	103	09.97	08.99									
	2.0 T	118	10.97	07.00									
	2.0 T	120	06.01	12.03									
	2.0 T	121	07.00	06.01									
	2.0 T4	147	07.00	12.03									
	1.6	77	09.95	08.99		BA2226				21861	15,3 /WK/S	LUC	
	1.6	80	03.99	12.03									
	1.8 (1731)	85	07.95	08.99									
	1.8 (1783)	90	03.99	12.03									
	1.8 i (1834)	90	06.01	12.03									
	1.8 i (1834)	92	03.98	12.03									

1) - 17" wheel / - ruota 17" / - roue 17" / - rueda 17"  
2) + 16" wheel / + ruota 16" / + roue 16" / + rueda 16"

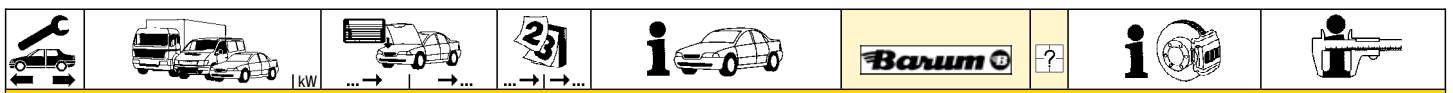







**VOLVO S40 I (95-03)**

	1.9 DI	70	03.99	07.00	BA2226		21861 15,3 /WK/S	LUC
	1.9 DI	75	07.00	12.03				
	1.9 DI	85	07.00	12.03				
	1.9 T4	147	05.97	07.00				
	1.9 TD	66	07.95	08.99				
	2.0	100	07.95	12.03				
	2.0	103	07.95	08.99				
	2.0 T	118	10.97	07.00				
	2.0 T	120	06.01	12.03				
	2.0 T	121	07.00	06.01				
2.0 T4	147	07.00	12.03					
	1.6	77	09.95	08.99	BAR10229		260 10,0 8,4	
	1.6	80	03.99	12.03				
	1.8 (1731)	85	07.95	08.99				
	1.8 (1783)	90	03.99	12.03				
	1.8 i (1834)	90	06.01	12.03				
	1.8 i (1834)	92	03.98	12.03				
	1.9 DI	70	03.99	07.00				
	1.9 DI	75	07.00	12.03				
	1.9 DI	85	07.00	12.03				
	1.9 T4	147	05.97	07.00				
	1.9 TD	66	07.95	08.99				
	2.0	100	07.95	12.03				
	2.0	103	07.95	08.99				
	2.0 T	118	10.97	07.00				
	2.0 T	120	06.01	12.03				
	2.0 T	121	07.00	06.01				
2.0 T4	147	07.00	12.03					

**VOLVO S40 II (04-)**

	1.6 D	80	04.07	- (USA) ↓	BA2234	- 17" Rad <sup>1)</sup>	23723 18,4 +	ATE
	1.6 D	81	01.05	- (USA) ↓				
	1.6 D2	84	10.10	- (USA) ↓				
	1.6 i	74	01.05	- (USA) ↓				
	1.8	92	04.04	- (USA) ↓				
	1.8 FlexiFuel	92	04.07	- (USA) ↓				
	2.0 D	100	01.04	- (USA) ↓				
	2.0 D3	110	10.10	- (USA) ↓				
	2.0 D4	96	07.05	- (USA) ↓				
	2.0 D4	130	10.10	- (USA) ↓				
	2.0 FlexiFuel	107	10.06	- (USA) ↓				
	2.0 i	107	10.06	- (USA) ↓				
	2.4	103	01.04	- (USA) ↓				
	2.4	125	01.04	- (USA) ↓				
	2.4 4X4	125	08.06	- (USA) ↓				
	2.4 D5	132	03.06	- (USA) ↓				
	2.5 T5	162	01.04	- (USA) ↓				
2.5 T5	169	03.07	- (USA) ↓					
2.5 T5 AWD	162	04.04	- (USA) ↓					
2.5 T5 AWD	169	03.07	- (USA) ↓					
	1.6 D	80	04.07		BAR25162	+ 16" Rad <sup>2)</sup>	300 25,0 23,0 V L	
	1.6 D	81	01.05					
	1.6 i	74	01.05					
	1.8	92	04.04					
	1.8 FlexiFuel	92	04.07					
	2.0 D	100	01.04					
	2.0 D4	96	07.05					
	2.0 FlexiFuel	107	10.06					
	2.0 i	107	10.06					
	2.4	103	01.04					
2.4	125	01.04						
2.4 4X4	125	08.06						
2.4 D5	132	03.06						
2.5 T5	162	01.04						
2.5 T5	169	03.07						
2.5 T5 AWD	162	04.04						
2.5 T5 AWD	169	03.07						
	1.6 D2	84	10.10		BAR25162	+ 16" Rad <sup>2)</sup>	300 25,0 23,0 V L	
	2.0 D3	110	10.10					
	2.0 D4	130	10.10					
	2.5 T5	162	01.04					
	1.6 D	80	04.07		BA2258		23482 16,4 +	ATE
	1.6 D	81	01.05					
	1.6 D2	84	10.10					
	1.6 i	74	01.05					
	1.8	92	04.04					
	1.8 FlexiFuel	92	04.07					
	2.0 D	100	01.04					
	2.0 D3	110	10.10					
	2.0 D4	96	07.05					
	2.0 D4	130	10.10					
	2.0 FlexiFuel	107	10.06					
	2.0 i	107	10.06					
	2.4	103	01.04					
	2.4	125	01.04					
	2.4 4X4	125	08.06					
	2.4 D5	132	03.06					
	2.5 T5	162	01.04					

1) - 17" wheel / - ruota 17" / - roue 17" / - rueda 17"  
 2) + 16" wheel / + ruota 16" / + roue 16" / + rueda 16"

VOLVO S40 II (04-)											
	2.5 T5 2.5 T5 AWD 2.5 T5 AWD	169 162 169	03.07 04.04 03.07			BA2258				23482 16,4 +	ATE
VOLVO S60 I (00-09)											
	2.0 T 2.3 T5 2.3 T5 2.4 2.4 2.4 Bi-Fuel 2.4 D 2.4 D 2.4 D5 2.4 D5 2.4 T 2.4 T AWD 2.4 T5 2.5 T 2.5 T AWD	132 184 195 103 125 103 93 96 120 136 147 147 191 154 154	09.01 08.00 07.00 11.00 11.00 06.02 09.05 12.01 07.01 09.05 11.00 11.01 04.04 02.04 04.04	01.09 04.04 09.02 01.09 01.09 01.09 01.09 01.09 01.09 01.09 01.09 01.09 01.09 01.09 01.09		BA2253		- 17" Rad 1)		23073 18,8 +	ATE
	2.0 T 2.3 T5 2.3 T5 2.4 2.4 2.4 Bi-Fuel 2.4 D 2.4 D 2.4 D5 2.4 D5 2.4 T 2.4 T AWD 2.4 T5 2.5 T 2.5 T AWD	132 184 195 103 125 103 93 96 120 136 147 147 191 154 154	09.01 08.00 07.00 11.00 11.00 06.02 09.05 12.01 07.01 09.05 11.00 11.01 04.04 02.04 04.04	01.09 04.04 09.02 01.09 01.09 01.09 01.09 01.09 01.09 01.09 01.09 01.09 01.09 01.09 01.09		BAR26122 BAR28123		+ 15" Rad 2) + 16" Rad 3)		286 26,0 23,0 V 305 27,9 25,0 V	
	2.0 T 2.3 T5 2.3 T5 2.4 2.4 2.4 Bi-Fuel 2.4 D 2.4 D 2.4 D5 2.4 D5 2.4 T 2.4 T AWD 2.4 T5 2.5 T 2.5 T AWD	132 184 195 103 125 103 93 96 120 136 147 147 191 154 154	09.01 08.00 07.00 11.00 11.00 06.02 09.05 12.01 07.01 09.05 11.00 11.01 04.04 02.04 04.04	01.09 04.04 09.02 01.09 01.09 01.09 01.09 01.09 01.09 01.09 01.09 01.09 01.09 01.09 01.09		BA2279				23076 17,2 +	ATE
VOLVO S60 II (10-)											
	1.6 D DRIVE 2.0 T D3 D5 D5 D5 AWD D5 AWD T3 T4 T4F T5 T6 AWD	84 149 120 151 158 151 158 110 132 132 176 224	01.11 04.10 04.10 04.10 06.11 04.10 06.11 04.10 04.10 04.11 04.10 04.10			BA2314		+ 16" Rad 3)		24123 20,2 +	ATE
						BA2314		+ 16" Rad 3)		24123 20,2 +	ATE
VOLVO S70 (97-00)											
	2.0 2.0 2.0 20V 2.0 20V 2.0 T 2.0 T 2.3 2.4 2.4 2.4 AWD 2.4 AWD 2.4 AWD 2.4 AWD 2.4 Blu-Fuel 2.4 T 2.5 2.5 2.5 Bifuel 2.5 Bifuel 2.5 TDI 2.5 TDi AWD	93 105 120 132 155 166 195 103 125 103 106 121 103 142 106 121 103 106 106 103 103	01.97 01.97 01.97 01.97 01.97 01.97 04.99 08.99 01.97 11.96 04.99 11.96 10.98 07.97 01.97 01.97 06.98 07.99 10.98 01.97 10.99	11.00 11.00 11.00 11.00 11.00 11.00 09.00 09.00 11.00 09.00 09.00 05.99 05.99 09.00 11.00 11.00 11.00 11.00 11.00 11.00 11.00 09.00		BA2244				21273 19,5 +/WE	ATE

1) - 17" wheel / - ruota 17" / - roue 17" / - rueda 17"  
2) + 15" wheel / + ruota 15" / + roue 15" / + rueda 15"  
3) + 16" wheel / + ruota 16" / + roue 16" / + rueda 16"









**VOLVO S70 (97-00)**

	2.3 T 2.3 T5	184 176	01.97 01.97	11.00 11.00	BA2244		21273 19,5 +WE	ATE
	2.0 2.0 2.0 20V 2.0 20V 2.0 T 2.0 T 2.3 2.3 T 2.3 T5 2.4 2.4 2.4 AWD 2.4 AWD 2.4 AWD 2.4 AWD 2.4 Blu-Fuel 2.4 T 2.5 2.5 2.5 Bifuel 2.5 Bifuel 2.5 TDI 2.5 TDi AWD	93 105 120 132 155 166 195 184 176 103 125 103 106 121 103 142 106 121 103 106 106 103 103	01.97 01.97 01.97 01.97 01.97 01.97 04.99 01.97 01.97 08.99 01.97 11.96 04.99 11.96 10.98 07.97 01.97 01.97 06.98 07.99 10.98 01.97 10.99	11.00 11.00 11.00 11.00 11.00 11.00 09.00 11.00 11.00 11.00 09.00 09.00 05.99 05.99 09.00 11.00 11.00 11.00 11.00 11.00 11.00 11.00 09.00	BAR26102	+ 15" Rad <sup>1)</sup>	280 26,0 23,0 V	
	2.0 2.0 2.0 20V 2.0 20V 2.0 T 2.0 T 2.3 2.3 T 2.3 T5 2.4 2.4 2.4 AWD 2.4 AWD 2.4 AWD 2.4 AWD 2.4 Blu-Fuel 2.4 T 2.5 2.5 2.5 Bifuel 2.5 Bifuel 2.5 TDI 2.5 TDi AWD	93 105 120 132 155 166 195 184 176 103 125 103 106 121 103 142 106 121 103 106 106 103 103	01.97 01.97 01.97 01.97 01.97 01.97 04.99 01.97 01.97 08.99 01.97 11.96 04.99 11.96 10.98 07.97 01.97 01.97 06.98 07.99 10.98 01.97 10.99	11.00 11.00 11.00 11.00 11.00 11.00 09.00 11.00 11.00 11.00 11.00 09.00 09.00 05.99 05.99 09.00 11.00 11.00 11.00 11.00 11.00 11.00 09.00	BA2162		21035 15,5	ATE

**VOLVO S80 I (98-06)**



	2.0 2.0 T 2.0 T 2.4 2.4 2.4 Bi-Fuel 2.4 D 2.4 D5 2.4 T 2.5 T 2.5 TDI 2.9 2.9 3.0	120 132 166 103 125 103 96 120 147 154 103 147 150 144	06.98 12.99 06.98 01.99 01.99 09.01 10.01 08.01 06.00 07.03 01.99 03.99 05.98 06.01	02.06 02.06 02.06 02.06 02.06 02.06 02.06 02.06 02.06 02.06 02.06 02.06 02.06 02.06	BA2253	- 17" Rad <sup>2)</sup>	23073 18,8 +	ATE
	2.8 T6 3.0 T6	200 200	05.98 06.01	02.06 02.06	BA2253	- 17" Rad <sup>2)</sup>	23073 18,8 +	ATE
	2.0 2.0 T 2.0 T 2.4 2.4 2.4 Bi-Fuel 2.4 D 2.4 D5 2.4 T 2.5 T 2.5 TDI 2.8 T6 2.9 2.9 3.0 3.0 T6	120 132 166 103 125 103 96 120 147 154 103 200 147 150 144 200	06.98 12.99 06.98 01.99 01.99 09.01 10.01 08.01 06.00 07.03 01.99 05.98 03.99 05.98 06.01 06.01	02.06 02.06 02.06 02.06 02.06 02.06 02.06 02.06 02.06 02.06 02.06 02.06 02.06 02.06 02.06 02.06	BAR26122 BAR28123	+ 15" Rad <sup>1)</sup> + 16" Rad <sup>3)</sup>	286 26,0 23,0 V 305 27,9 25,0 V	

<sup>1)</sup> + 15" wheel / + ruota 15" / + roue 15" / + rueda 15"  
<sup>2)</sup> - 17" wheel / - ruota 17" / - roue 17" / - rueda 17"  
<sup>3)</sup> + 16" wheel / + ruota 16" / + roue 16" / + rueda 16"



		kW		...		...		...		...		...		...		...		...			
<b>VOLVO S80 I (98-06)</b>																					
	2.0	120	06.98	02.06					BA2279					23076	17,2 +	ATE					
	2.0 T	132	12.99	02.06																	
	2.0 T	166	06.98	02.06																	
	2.4	103	01.99	02.06																	
	2.4	125	01.99	02.06																	
	2.4 Bi-Fuel	103	09.01	02.06																	
	2.4 D	96	10.01	02.06																	
	2.4 D5	120	08.01	02.06																	
	2.4 T	147	06.00	02.06																	
	2.5 T	154	07.03	02.06																	
	2.5 TDI	103	01.99	02.06																	
	2.8 T6	200	05.98	02.06																	
	2.9	147	03.99	02.06																	
	2.9	150	05.98	02.06																	
	3.0	144	06.01	02.06																	
	3.0 T6	200	06.01	02.06																	
<b>VOLVO S80 II (06-)</b>																					
	1.6 D DRIVE		01.10						BA2314					+ 16" Rad <sup>1)</sup>	24123	20,2 +	ATE				
	2.0	107	09.07																		
	2.0 D	100	09.07																		
	2.0 FlexiFuel	107	09.07																		
	2.0 T	149	01.10																		
	2.0 TDi	100	02.08																		
	2.4 D	120	03.06																		
	2.4 D	129	04.09																		
	2.4 D5	136	03.06																		
	2.4 D5	151	11.08																		
	2.4 D5	158	06.11																		
	2.4 D5 AWD	136	01.07																		
	2.4 D5 AWD	151	01.10																		
	2.4 D5 AWD	158	06.11																		
	2.5 T	147	03.06																		
	2.5 T	170	01.10																		
	2.5 T AWD	147	10.06																		
	2.5 T FlexFuel	147	04.08																		
	2.5 T FlexiFuel	170	01.10																		
	3.0 T6 AWD	210	01.07																		
	3.2		03.06																		
	3.2 AWD		01.07																		
	D3	120	01.10																		
	T4	132	10.10																		
	T4F	132	05.11																		
	T5	177	10.10																		
	4.4 V8 AWD	232	03.06						BA2314					+ 16" Rad <sup>1)</sup>	24123	20,2 +	ATE				
	T6 AWD	224	10.10																		
<b>VOLVO S90 (97-98)</b>																					
	2.5	125	11.96	10.98					BA2181						20164	18,2	LUC				
	2.5	132	11.96	10.97																	
	2.9	132	01.97	05.98																	
	2.9	150	01.97	05.98																	
	2.5	125	11.96	10.98					BAR26102						280	26,0	23,0 V				
	2.5	132	11.96	10.98																	
	2.9	132	01.97	05.98																	
	2.9	150	01.97	05.98																	
<b>VOLVO V40 (95-04)</b>																					
	1.6	77	12.95	08.97					BA2268						21920	15,1	/WK/S	LUC			
	1.8 (1731)	85	07.95	08.97																	
	1.9 T4	147	05.97	08.97																	
	1.9 TD	66	07.95	08.97																	
	2.0	100	07.95	08.97																	
	2.0	103	07.95	08.97																	
	1.6	77	09.97	08.99					BA2237						21983	17,3	/WK/Zub	LUC			
	1.6	80	03.99	07.04																	
	1.8 (1731)	85	09.97	08.99																	
	1.8 (1783)	90	03.99	07.04																	
	1.8 i (1834)	90	06.01	07.04																	
	1.8 i (1834)	92	03.98	07.04																	
	1.9 DI	70	03.99	07.00																	
	1.9 DI	75	07.00	07.04																	
	1.9 DI	85	07.00	07.04																	
	1.9 T4	147	09.97	07.00																	
	1.9 TD	66	09.97	08.99																	
	2.0	100	09.97	07.04																	
	2.0	103	09.97	08.99																	
	2.0 T	118	10.97	07.00																	
	2.0 T	120	06.01	07.04																	
	2.0 T	121	07.00	06.01																	
	2.0 T4	147	07.00	04.04																	
	1.6	77	12.95	08.97					BAR24136						256	24,0	21,5 V				
	1.8 (1731)	85	07.95	08.97																	
	1.9 T4	147	05.97	08.97																	
	1.9 TD	66	07.95	08.97																	
	2.0	100	07.95	08.97																	
	2.0	103	07.95	08.97																	

<sup>1)</sup> + 16" wheel / + ruota 16" / + roue 16" / + rueda 16"

**VOLVO V40 (95-04)**

	1.6 1.6 1.8 (1731) 1.8 (1783) 1.8 i (1834) 1.8 i (1834) 1.9 DI 1.9 DI 1.9 DI 1.9 T4 1.9 TD 2.0 2.0 2.0 T 2.0 T 2.0 T 2.0 T4	77 80 85 90 90 92 70 75 85 147 66 100 103 118 120 121 147		09.97 03.99 09.97 03.99 06.01 03.98 03.99 07.00 07.00 09.97 09.97 09.97 10.97 06.01 07.00 07.00	08.99 07.04 08.99 07.04 07.04 07.04 07.00 07.04 07.04 07.00 08.99 07.04 08.99 07.00 07.04 06.01 04.04	BAR24159		281 24,0 21,5 V
	1.6 1.6 1.8 (1731) 1.8 (1783) 1.8 i (1834) 1.8 i (1834) 1.9 DI 1.9 DI 1.9 DI 1.9 DI 1.9 T4 1.9 TD 2.0 2.0 2.0 T 2.0 T 2.0 T 2.0 T4	77 80 85 90 90 92 70 75 85 147 66 100 103 118 120 121 147		12.95 03.99 07.95 03.99 06.01 03.98 03.99 07.00 07.00 05.97 07.95 07.95 07.95 10.97 06.01 07.00 07.00	08.99 07.04 08.99 07.04 07.04 07.04 07.00 07.04 07.04 07.00 08.99 07.04 08.99 07.04 07.04 06.01 04.04	BA2226		21861 15,3 /WK/S LUC
	1.6 1.6 1.8 (1731) 1.8 (1783) 1.8 i (1834) 1.8 i (1834) 1.9 DI 1.9 DI 1.9 DI 1.9 DI 1.9 T4 1.9 TD 2.0 2.0 2.0 T 2.0 T 2.0 T 2.0 T4	77 80 85 90 90 92 70 75 85 147 66 100 103 118 120 121 147		12.95 03.99 07.95 03.99 06.01 03.98 03.99 07.00 07.00 05.97 07.95 07.95 07.95 10.97 06.01 07.00 07.00	08.99 07.04 08.99 07.04 07.04 07.04 07.00 07.04 07.04 07.00 08.99 07.04 08.99 07.04 07.04 06.01 04.04	BAR10229		260 10,0 8,4

**VOLVO V50 (04-)**

	1.6 D 1.6 D 1.6 D2 1.6 i 1.8 1.8 FlexiFuel 2.0 D 2.0 D3 2.0 D4 2.0 FlexiFuel 2.0 i 2.4 2.4 2.4 AWD 2.4 D5 2.4 Tdi 2.5 T5 2.5 T5 2.5 T5 AWD 2.5 T5 AWD	80 81 84 74 92 92 100 110 130 107 107 103 125 125 132 120 162 169 162 169		04.07 01.05 01.10 01.05 04.04 04.07 04.04 10.10 10.10 01.10 10.06 04.04 04.04 08.06 03.06 05.07 04.04 03.07 04.04 03.07	- (USA) ↓ - (USA) ↓	BA2234	- 17" Rad <sup>1)</sup>	23723 18,4 + ATE
	1.6 D 1.6 D 1.6 i 1.8 1.8 FlexiFuel 2.0 D 2.0 FlexiFuel 2.0 i 2.4 2.4 2.4 AWD 2.4 D5 2.4 Tdi 2.5 T5	80 81 74 92 92 100 107 107 103 125 125 132 120 162		04.07 01.05 01.05 04.04 04.07 04.04 01.10 10.06 04.04 04.04 08.06 03.06 05.07 04.04		BAR25162	+ 16" Rad <sup>2)</sup>	300 25,0 23,0 V L

1) - 17" wheel / - ruota 17" / - roue 17" / - rueda 17"  
2) + 16" wheel / + ruota 16" / + roue 16" / + rueda 16"

**VOLVO V50 (04-)**

	2.5 T5	169	03.07	BAR25162	+ 16" Rad <sup>1)</sup>	300 25,0 23,0 V L
	2.5 T5 AWD	162	04.04			
	2.5 T5 AWD	169	03.07			
	1.6 D2	84	01.10	BAR25162	+ 16" Rad <sup>1)</sup>	300 25,0 23,0 V L
	2.0 D3	110	10.10			
	2.0 D4	130	10.10			
	1.6 D	80	04.07	BA2258		23482 16,4 + ATE
	1.6 D	81	01.05			
	1.6 D2	84	01.10			
	1.6 i	74	01.05			
	1.8	92	04.04			
	1.8 FlexiFuel	92	04.07			
	2.0 D	100	04.04			
	2.0 D3	110	10.10			
	2.0 D4	130	10.10			
	2.0 FlexiFuel	107	01.10			
	2.0 i	107	10.06			
	2.4	103	04.04			
	2.4	125	04.04			
	2.4 AWD	125	08.06			
	2.4 D5	132	03.06			
	2.4 Tdi	120	05.07			
	2.5 T5	162	04.04			
2.5 T5	169	03.07				
2.5 T5 AWD	162	04.04				
2.5 T5 AWD	169	03.07				

**VOLVO V60 (10-)**

	1.6 DRiVe	84	06.11	BA2314	+ 16" Rad <sup>1)</sup>	24123 20,2 + ATE
	2.0 T	149	11.10			
	2.4 D5	158	06.11			
	2.4 D5 AWD	158	06.11			
	D 3	120	11.10			
	D 5	151	11.10			
	D 5 AWD	151	11.10			
	T3	110	11.10			
	T4	132	11.10			
	T4F	132	04.11			
	T5	177	11.10			
	T 6 AWD	224	11.10			

**VOLVO V70 I (97-00)**

	2.0	93	01.97	03.00	BA2244		21273 19,5 +/WE ATE				
	2.0	105	01.97	03.00							
	2.0 20V	120	01.97	03.00							
	2.0 20V	132	01.97	03.00							
	2.0 T	155	01.97	03.00							
	2.3 AWD		04.97	09.98							
	2.3 T5 AWD	176	01.97	03.00							
	2.4	103	08.99	03.00							
	2.4	125	01.97	03.00							
	2.4 AWD	121	10.98	05.99							
	2.4 Bi-Fuel	103	08.99	03.00							
	2.4 T	142	01.97	03.00							
	2.5	106	01.97	03.00							
	2.5	121	06.98	03.00							
	2.5 Bi-Fuel	106	10.98	08.99							
	2.5 T AWD	142	01.97	03.00							
	2.5 TDI	103	01.97	03.00							
	2.0 T	166	01.97	03.00	BA2244		21273 19,5 +/WE ATE				
	2.0 T AWD	166	01.97	03.00							
	2.3 T	184	01.97	03.00							
	2.3 T AWD	184	04.97	03.00							
	2.3 T5	176	01.97	03.00							
	2.5 AWD	195	03.99	03.00							
		2.0	93	01.97				03.00	BAR26102	+ 15" Rad <sup>2)</sup>	280 26,0 23,0 V
		2.0	105	01.97				03.00			
2.0 20V		120	01.97	03.00							
2.0 20V		132	01.97	03.00							
2.0 T		155	01.97	03.00							
2.0 T		166	01.97	03.00							
2.0 T AWD		166	01.97	03.00							
2.3 AWD			04.97	09.98							
2.3 T		184	01.97	03.00							
2.3 T AWD		184	04.97	03.00							
2.3 T5		176	01.97	03.00							
2.3 T5 AWD		176	01.97	03.00							
2.4		103	08.99	03.00							
2.4		125	01.97	03.00							
2.4 AWD		121	10.98	05.99							
2.4 Bi-Fuel		103	08.99	03.00							
2.4 T		142	01.97	03.00							
2.5		106	01.97	03.00							
2.5		121	06.98	03.00							
2.5 AWD	195	03.99	03.00								
2.5 Bi-Fuel	106	10.98	08.99								
2.5 T AWD	142	01.97	03.00								

<sup>1)</sup> + 16" wheel / + ruota 16" / + roue 16" / + rueda 16"  
<sup>2)</sup> + 15" wheel / + ruota 15" / + roue 15" / + rueda 15"

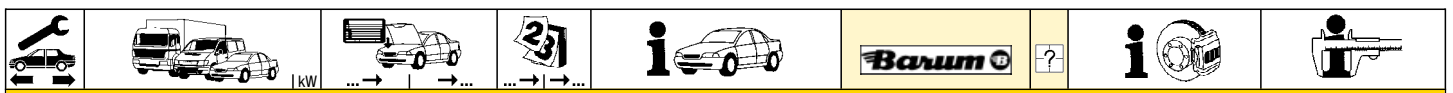

**VOLVO V70 I (97-00)**

	2.5 TDI	103		01.97	03.00	BAR26102	+ 15" Rad <sup>1)</sup>	280 26,0 23,0 V
	2.0	93		01.97	12.99	BA2162		23035 15,5 ATE
	2.0	105		01.97	12.99			
	2.0 20V	120		01.97	12.99			
	2.0 20V	132		01.97	12.99			
	2.0 T	155		01.97	12.99			
	2.0 T	166		01.97	12.99			
	2.3 AWD			04.97	09.98			
	2.3 T	184		01.97	12.99			
	2.3 T5	176		01.97	12.99			
	2.4	103		08.99	12.99			
	2.4	125		01.97	12.99			
	2.4 AWD	121		10.98	05.99			
	2.4 Bi-Fuel	103		08.99	12.99			
	2.4 T	142		01.97	12.99			
	2.5	106		01.97	12.99			
	2.5	121		06.98	12.99			
	2.5 Bi-Fuel	106		10.98	08.99			
	2.5 TDI	103		01.97	12.99			
	2.0	93		01.00	03.00	BA2279		23076 17,2 + ATE
	2.0	105		01.00	03.00			
	2.0 20V	120		01.00	03.00			
	2.0 20V	132		01.00	03.00			
	2.0 T	155		01.00	03.00			
	2.0 T	166		01.00	03.00			
	2.0 T AWD	166		01.00	03.00			
	2.3 T	184		01.00	03.00			
	2.3 T AWD	184		01.00	03.00			
	2.3 T5	176		01.00	03.00			
	2.3 T5 AWD	176		01.00	03.00			
	2.4	103		01.00	03.00			
	2.4	125		01.00	03.00			
	2.4 Bi-Fuel	103		01.00	03.00			
	2.4 T	142		01.00	03.00			
	2.5	106		01.00	03.00			
	2.5	121		01.00	03.00			
	2.5 AWD	195		01.00	03.00			
	2.5 T AWD	142		01.00	03.00			
	2.5 TDI	103		01.00	03.00			

**VOLVO V70 II (00-07)**

	2.0 T	132		07.01	07.07	BA2253	- 17" Rad <sup>2)</sup>	23073 18,8 + ATE
	2.3	195		10.00	09.04			
	2.4			03.00	07.07			
	2.4	103		03.00	07.07			
	2.4 4X4	121		03.00	09.03			
	2.4 Bi-Fuel	103		09.01	07.07			
	2.4 D	93		05.05	07.07			
	2.4 D	96		12.01	07.07			
	2.4 D5	120		08.01	07.07			
	2.4 D5	136		12.05	07.07			
	2.4 D5 AWD	120		03.03	07.07			
	2.4 D5 AWD	136		12.05	07.07			
	2.4 T	147		03.00	07.07			
	2.4 T AWD	147		09.01	07.07			
	2.5 T	154		04.04	07.07			
	2.5 T AWD	154		09.02	07.07			
	2.5 TDI	103		03.00	07.07			
	2.3 T5	184		03.00	07.07	BA2253	- 17" Rad <sup>2)</sup>	23073 18,8 + ATE
	2.4 T5	191		04.04	07.07			
	2.0 T	132		07.01	07.07	BAR26122 BAR28123	+ 15" Rad <sup>1)</sup> + 16" Rad <sup>3)</sup>	286 26,0 23,0 V 305 27,9 25,0 V
	2.3	195		10.00	09.04			
	2.3 T5	184		03.00	07.07			
	2.4			03.00	07.07			
	2.4	103		03.00	07.07			
	2.4 4X4	121		03.00	09.03			
	2.4 Bi-Fuel	103		09.01	07.07			
	2.4 D	93		05.05	07.07			
	2.4 D	96		12.01	07.07			
	2.4 D5	120		08.01	07.07			
	2.4 D5	136		12.05	07.07			
	2.4 D5 AWD	120		03.03	07.07			
	2.4 D5 AWD	136		12.05	07.07			
	2.4 T	147		03.00	07.07			
	2.4 T AWD	147		09.01	07.07			
	2.4 T5	191		04.04	07.07			
	2.5 T	154		04.04	07.07			
	2.5 T AWD	154		09.02	07.07			
	2.5 TDI	103		03.00	07.07			
	2.0 T	132		07.01	07.07	BA2279		23076 17,2 + ATE
	2.3	195		10.00	09.04			
	2.3 T5	184		03.00	07.07			
	2.4			03.00	07.07			
	2.4	103		03.00	07.07			
	2.4 4X4	121		03.00	09.03			

<sup>1)</sup> + 15" wheel / + ruota 15" / + roue 15" / + rueda 15"

<sup>2)</sup> - 17" wheel / - ruota 17" / - roue 17" / - rueda 17"

<sup>3)</sup> + 16" wheel / + ruota 16" / + roue 16" / + rueda 16"



<b>VOLVO V70 II (00-07)</b>															
	2.4 Bi-Fuel	103		09.01	07.07			BA2279						23076 17,2 +	ATE
	2.4 D	93		05.05	07.07										
	2.4 D	96		12.01	07.07										
	2.4 D5	120		08.01	07.07										
	2.4 D5	136		12.05	07.07										
	2.4 D5 AWD	120		03.03	07.07										
	2.4 D5 AWD	136		12.05	07.07										
	2.4 T	147		03.00	07.07										
	2.4 T AWD	147		09.01	07.07										
	2.4 T5	191		04.04	07.07										
	2.5 T	154		04.04	07.07										
	2.5 T AWD	154		09.02	07.07										
	2.5 TDI	103		03.00	07.07										
<b>VOLVO V70 III (07-)</b>															
	1.6 DRIVe			01.10				BA2314		+ 16" Rad <sup>1)</sup>				24123 20,2 +	ATE
	1.6 T4F	132		01.11											
	2.0	107		10.07											
	2.0 D	100		10.07											
	2.0 D3	120		03.10											
	2.0 FlexiFuel	107		09.07											
	2.0 T	149		01.10											
	2.4 D	120		08.07											
	2.4 D	129		10.09											
	2.4 D5	136		08.07											
	2.4 D5	151		12.09											
	2.4 D5	158		06.11											
	2.4 D5 AWD	136		10.07											
	2.4 D5 AWD	151		12.09											
	2.4 D5 AWD	158		06.11											
	2.5 T	147		08.07											
	2.5 T	170		10.09											
	2.5 T FlexiFuel	147		04.08											
	2.5 T FlexiFuel	170		10.09											
	3.0 T6 AWD	210		08.07											
	3.0 T6 AWD	224		04.11											
	3.2	175		08.07											
	3.2 AWD	175		08.07											
	T4	132		10.10											
	T5	177		01.10											
<b>VOLVO V90 (97-98)</b>															
	2.5	125		11.96	10.98			BA2181						20164 18,2	LUC
	2.5	132		11.96	10.97										
	2.9	132		01.97	12.98										
	2.9	150		01.97	12.98										
	2.5	125		11.96	10.98			BAR26102						280 26,0 23,0 V	
	2.5	132		11.96	10.97										
	2.9	132		01.97	12.98										
	2.9	150		01.97	12.98										
<b>VOLVO XC70 I CROSS COUNTRY (00-07)</b>															
	2.4 AWD	121		03.00	09.03			BA2253						23073 18,8 +	ATE
	2.4 D5 AWD	136		12.05	07.07										
	2.4 T XC AWD			11.97	09.02										
	2.5 D5 XC AWD	120		09.02	07.07										
	2.5 T XC AWD	154		09.02	07.07										
	2.4 AWD	121		03.00	09.03			BAR26122		+ 15" Rad <sup>2)</sup>				286 26,0 23,0 V	
	2.4 D5 AWD	136		12.05	07.07			BAR28123		+ 16" Rad <sup>1)</sup>				305 27,9 25,0 V	
	2.4 T XC AWD			11.97	09.02										
	2.5 D5 XC AWD	120		09.02	07.07										
	2.5 T XC AWD	154		09.02	07.07										
	2.4 AWD	121		03.00	09.03			BA2279						23076 17,2 +	ATE
	2.4 D5 AWD	136		12.05	07.07										
	2.4 T XC AWD			11.97	09.02										
	2.5 D5 XC AWD	120		09.02	07.07										
	2.5 T XC AWD	154		09.02	07.07										
<b>VOLVO XC70 II CROSS COUNTRY (07-)</b>															
	2.0 D3	120		08.11				BA2314		+ 16" Rad <sup>1)</sup>				24123 20,2 +	ATE
	2.0 D3 AWD	120		08.11											
	2.4 D	129		01.10											
	2.4 D AWD	120		08.07											
	2.4 D5 AWD	136		08.07											
	2.4 D5 AWD	151		12.09											
	2.4 D5 AWD	158		06.11											
	3.0 T6 AWD	210		01.08											
	3.0 T6 AWD	224		01.10											
	3.2	179		08.07											
	3.2 AWD	175		08.07											
	3.2 AWD	179		08.07											

<sup>1)</sup> + 16" wheel / + ruota 16" / + roue 16" / + rueda 16"

<sup>2)</sup> + 15" wheel / + ruota 15" / + roue 15" / + rueda 15"





# Neue Artikel

Nouvelles références / Codici nuovi / Novo artigos /  
Nowe artykuły / Nové výrobky

 			 		
BA2255	OPEL	ASTRA H / GTC / Vauxhall Astra MKV (04-10)	BA2262	FORD	TRANSIT (00-06)
BA2255	OPEL	ASTRA H Caravan/Vau. Astra MKV Estate (04-10)	BA2263	MERCEDES BENZ	VIANO (BM639) (03-)
BA2255	OPEL	ASTRA H TwinTop (06-)	BA2263	MERCEDES BENZ	VITO (BM639) (03-)
BA2255	OPEL	COMBO / Vauxhall Combo (01-)	BA2264	MERCEDES BENZ	VIANO (BM639) (03-)
BA2255	OPEL	CORSA C / Vauxhall Corsa MK II (00-06)	BA2264	MERCEDES BENZ	VITO (BM639) (03-)
BA2255	OPEL	CORSA D / Vauxhall Corsa MK III (06-)	BA2265	CITROEN	JUMPER (06-)
BA2255	OPEL	MERIVA A / Vauxhall Meriva A (02-10)	BA2265	FIAT	DUCATO (06-)
BA2255	OPEL	MERIVA B (10-)	BA2265	PEUGEOT	BOXER (06-)
BA2255	OPEL	ZAFIRA II / Vauxhall Zafira II (05-11)	BA2266	MERCEDES BENZ	A-Klasse (W169 ) (04-11)
BA2256	OPEL	CORSA D / Vauxhall Corsa MK III (06-)	BA2266	MERCEDES BENZ	B-Klasse (W245) (05-11)
BA2257	MAZDA	323 Limousine/323 F/323 P/323 S (98-03)	BA2267	MINI	R50/R53 (00-06)
BA2257	MAZDA	6 Limousine (GG) (02-07)	BA2267	MINI	R52 Cabrio (04-08)
BA2257	MAZDA	6 Kombi (GY) (02-07)	BA2268	MINI	R52 Cabrio (04-08)
BA2257	MAZDA	6 (07-)	BA2268	MITSUBISHI	CARISMA (95-06)
BA2257	MAZDA	626 (97-02)	BA2268	MITSUBISHI	COLT (04-)
BA2257	MAZDA	626 Kombi (98-02)	BA2268	MITSUBISHI	COLT CZC Cabriolet (06-08)
BA2257	MAZDA	PREMACY (99-05)	BA2268	MITSUBISHI	SPACE STAR (98-06)
BA2258	FORD	C-MAX (07-10)	BA2268	MITSUBISHI	SPACE STAR (98-06)
BA2258	FORD	C-MAX / GRAND C-MAX (10-)	BA2268	SMART	FORFOUR (BM454) (04-06)
BA2258	FORD	FOCUS II (05-11)	BA2268	SMART	FORFOUR (BM454) (04-06)
BA2258	FORD	FOCUS III (11-)	BA2268	VOLVO	S40 I (95-03)
BA2258	FORD	FOCUS C-MAX (03-07)	BA2268	VOLVO	V40 (95-04)
BA2258	MAZDA	3 (03-09)	BA2269	FORD	GALAXY I (95-06)
BA2258	MAZDA	3 (09-)	BA2269	SEAT	ALHAMBRA I (7V) (96-10)
BA2258	MAZDA	5 (05-)	BA2269	SEAT	ALHAMBRA I (7V) (96-10)
BA2258	MAZDA	PREMACY (05-)	BA2269	VOLKSWAGEN	SHARAN I (95-10)
BA2258	OPEL	GT (07-09)	BA2271	ALFA ROMEO	147 (01-10)
BA2258	OPEL	SIGNUM / Vauxhall Signum (03-08)	BA2271	ALFA ROMEO	156 (97-05)
BA2258	SAAB	9-3 Limousine (YS3F) (03-)	BA2271	ALFA ROMEO	GT (04-10)
BA2258	SAAB	9-3 SportCombi (05-)	BA2271	ALFA ROMEO	GT (04-10)
BA2258	SAAB	9-3 Cabriolet (YS3F) (03-)	BA2271	FIAT	LINEA (07-11)
BA2258	SAAB	9-3 X (09-)	BA2271	LANCIA	LYBRA (99-05)
BA2258	VOLVO	C30 Coupe (06-)	BA2272	LANCIA	LYBRA (99-05)
BA2258	VOLVO	C70 II Cabrio (06-)	BA2272	MINI	R50/R53 (00-06)
BA2258	VOLVO	S40 II (04-)	BA2272	MINI	R52 Cabrio (04-08)
BA2258	VOLVO	V50 (04-)	BA2273	MINI	R52 Cabrio (04-08)
BA2259	AUDI	A4 (B6/B7) (01-08)	BA2273	NISSAN	ALMERA (N16) (00-06)
BA2259	AUDI	A4 Cabrio (02-08)	BA2273	NISSAN	ALMERA (N16) (00-06)
BA2259	AUDI	A6 (4F2/C6) Limousine (04-11)	BA2273	NISSAN	PRIMERA (P11E) Limousine (96-02)
BA2259	AUDI	A6 (4F5/C6) Avant (05-11)	BA2273	NISSAN	PRIMERA (P11E) Limousine (96-02)
BA2259	AUDI	A6 Allroad (06-11)	BA2273	NISSAN	PRIMERA (W11) Kombi (98-02)
BA2259	AUDI	A8 (03-09)	BA2274	NISSAN	PRIMERA (W11) Kombi (98-02)
BA2259	SEAT	EXEO / ST (09-)	BA2274	HONDA	CITY (08-)
BA2260	OPEL	AGILA (00-07)	BA2274	HONDA	CITY (08-)
BA2260	SUBARU	JUSTY (G3X) (03-07)	BA2274	HONDA	CIVIC (3-türig) (91-95)
BA2260	SUZUKI	IGNIS II (03-)	BA2274	HONDA	CIVIC (3-türig) (91-95)
BA2260	SUZUKI	WAGON R+ (00-)	BA2274	HONDA	CIVIC (4-türig) (91-95)
BA2261	NISSAN	INTERSTAR (X70) (02-)	BA2274	HONDA	CIVIC (3/4-türig) (95-01)
BA2261	OPEL	MOVANO A (98-10)	BA2274	HONDA	CIVIC (3/4-türig) (95-01)
BA2261	RENAULT	MASTER II Bus (JD/ND_) (98-06)	BA2274	HONDA	CIVIC COUPE (94-95)
BA2261	RENAULT	MASTER II Kasten (FD_) (98-06)	BA2274	HONDA	CIVIC COUPE (94-95)
BA2261	RENAULT	MASTER II Pritsche/Fahrgestell (ED/HD/UD_) (98-06)	BA2274	HONDA	CIVIC COUPE (96-01)
BA2261	RENAULT	MASTER III Bus (JD_) (06-)	BA2274	HONDA	CIVIC COUPE (96-01)
BA2261	RENAULT	MASTER III Kasten (FD_) (06-)	BA2274	HONDA	JAZZ (02-08)
BA2261	RENAULT	MASTER III Pritsche/Fahrgestell (ED/HD/UD_) (06-)	BA2274	HONDA	JAZZ (08-)
BA2261	RENAULT	MASTER III Pritsche/Fahrgestell (ED/HD/UD_) (06-)	BA2274	HONDA	JAZZ (08-)
BA2261	RENAULT	MASTER III Pritsche/Fahrgestell (ED/HD/UD_) (06-)	BA2274	HONDA	LOGO (99-02)
BA2261	RENAULT	MASTER III Pritsche/Fahrgestell (ED/HD/UD_) (06-)	BA2275	CITROEN	JUMPER (06-)
BA2261	RENAULT	MASTER III Pritsche/Fahrgestell (ED/HD/UD_) (06-)	BA2275	FIAT	DUCATO (06-)
BA2261	RENAULT	MASTER III Pritsche/Fahrgestell (ED/HD/UD_) (06-)	BA2275	FIAT	DUCATO (06-)
BA2261	RENAULT	MASTER III Pritsche/Fahrgestell (ED/HD/UD_) (06-)	BA2275	PEUGEOT	BOXER (06-)
BA2261	RENAULT	MASTER III Pritsche/Fahrgestell (ED/HD/UD_) (06-)	BA2276	PEUGEOT	BOXER (06-)
BA2261	RENAULT	MASTER III Pritsche/Fahrgestell (ED/HD/UD_) (06-)	BA2276	FORD	COUGAR (98-00)
BA2261	RENAULT	MASTER III Pritsche/Fahrgestell (ED/HD/UD_) (06-)	BA2276	FORD	COUGAR (98-00)
BA2261	RENAULT	MASTER III Pritsche/Fahrgestell (ED/HD/UD_) (06-)	BA2276	FORD	MONDEO I (93-96)
BA2261	RENAULT	MASTER III Pritsche/Fahrgestell (ED/HD/UD_) (06-)	BA2276	FORD	MONDEO I (93-96)
BA2261	RENAULT	MASTER III Pritsche/Fahrgestell (ED/HD/UD_) (06-)	BA2276	FORD	MONDEO II (96-00)
BA2261	RENAULT	MASTER III Pritsche/Fahrgestell (ED/HD/UD_) (06-)	BA2276	FORD	MONDEO II (96-00)
BA2261	RENAULT	MASTER III Pritsche/Fahrgestell (ED/HD/UD_) (06-)	BA2277	MERCEDES BENZ	Transporter (BM 906) SPRINTER (06-)
BA2261	RENAULT	MASTER III Pritsche/Fahrgestell (ED/HD/UD_) (06-)	BA2277	MERCEDES BENZ	Transporter (BM 906) SPRINTER (06-)
BA2261	RENAULT	MASTER III Pritsche/Fahrgestell (ED/HD/UD_) (06-)	BA2277	VOLKSWAGEN	CRAFTER (06-)
BA2261	RENAULT	MASTER III Pritsche/Fahrgestell (ED/HD/UD_) (06-)	BA2277	VOLKSWAGEN	CRAFTER (06-)
BA2261	RENAULT	MASTER III Pritsche/Fahrgestell (ED/HD/UD_) (06-)	BA2278	HONDA	ACCORD (98-02)
BA2261	RENAULT	MASTER III Pritsche/Fahrgestell (ED/HD/UD_) (06-)	BA2278	HONDA	ACCORD (98-02)
BA2261	RENAULT	MASTER III Pritsche/Fahrgestell (ED/HD/UD_) (06-)	BA2278	MG	ZR (01-05)
BA2261	RENAULT	MASTER III Pritsche/Fahrgestell (ED/HD/UD_) (06-)	BA2278	MG	ZR (01-05)
BA2261	RENAULT	MASTER III Pritsche/Fahrgestell (ED/HD/UD_) (06-)	BA2278	MG	ZS (01-05)
BA2261	RENAULT	MASTER III Pritsche/Fahrgestell (ED/HD/UD_) (06-)	BA2278	MG	ZS (01-05)
BA2261	RENAULT	MASTER III Pritsche/Fahrgestell (ED/HD/UD_) (06-)	BA2278	NISSAN	ALMERA TINO (V10M) (00-05)
BA2261	RENAULT	MASTER III Pritsche/Fahrgestell (ED/HD/UD_) (06-)	BA2278	NISSAN	ALMERA TINO (V10M) (00-05)
BA2261	RENAULT	MASTER III Pritsche/Fahrgestell (ED/HD/UD_) (06-)	BA2278	NISSAN	PRIMERA (P12E) Limousine (02-08)
BA2261	RENAULT	MASTER III Pritsche/Fahrgestell (ED/HD/UD_) (06-)	BA2278	NISSAN	PRIMERA (P12E) Limousine (02-08)
BA2261	RENAULT	MASTER III Pritsche/Fahrgestell (ED/HD/UD_) (06-)	BA2278	NISSAN	PRIMERA (W12) Kombi (02-08)
BA2261	RENAULT	MASTER III Pritsche/Fahrgestell (ED/HD/UD_) (06-)	BA2278	NISSAN	PRIMERA (W12) Kombi (02-08)





# Neue Artikel

Nouvelles références / Codici nuovi / Novo artigos /  
Nowe artykuły / Nové výrobky

 			 		
BA2279	VOLVO	S60 I (00-09)	BA2285	LANCIA	PHEDRA (02-10)
BA2279	VOLVO	S80 I (98-06)	BA2285	PEUGEOT	807 (02-)
BA2279	VOLVO	V70 I (97-00)	BA2285	PEUGEOT	EXPERT Kombi (95-06)
BA2279	VOLVO	V70 II (00-07)	BA2285	PEUGEOT	EXPERT Kasten (95-06)
BA2279	VOLVO	XC70 I CROSS COUNTRY (00-07)	BA2285	PEUGEOT	EXPERT Pritsche/Fahrgestell (95-06)
BA2280	HONDA	ACCORD (90-93)	BA2286	FORD	COUGAR (98-00)
BA2280	HONDA	ACCORD (93-98)	BA2286	FORD	MONDEO I (93-96)
BA2280	HONDA	ACCORD Coupe (98-03)	BA2286	FORD	MONDEO II (96-00)
BA2280	HONDA	CIVIC (3-türig) (01-05)	BA2287	FORD	MONDEO III (00-06)
BA2280	HONDA	CIVIC (5-türig) (97-01)	BA2287	JAGUAR	X-Type (CF1) Limousine (01-)
BA2280	HONDA	CIVIC (5-türig) (01-05)	BA2287	JAGUAR	X-Type (CF1) Kombi (04-)
BA2280	HONDA	CIVIC Hatchback (FK/FN) (05-)	BA2288	RENAULT	LAGUNA II Limousine (BG_) (01-07)
BA2280	HONDA	CIVIC Stufenheck (FD) (05-)	BA2288	RENAULT	LAGUNA II Grandtour (KG_) (01-07)
BA2280	HONDA	CIVIC AERODECK (98-01)	BA2289	CITROEN	BERLINGO (MF) Kombi (96-08)
BA2280	HONDA	CIVIC COUPE (01-04)	BA2289	CITROEN	C3 (02-09)
BA2280	HONDA	INSIGHT (09-)	BA2289	CITROEN	C3 II (09-)
BA2280	HONDA	INTEGRA R (97-01)	BA2289	CITROEN	XSARA Picasso (N68) (00-10)
BA2280	HONDA	PRELUDE (92-96)	BA2289	FIAT	DOBLO (01-10)
BA2280	HONDA	PRELUDE (96-00)	BA2289	FIAT	IDEA (04-)
BA2280	HONDA	S2000 (99-04)	BA2289	LANCIA	MUSA (04-)
BA2280	MG	ZR (01-05)	BA2290	MERCEDES BENZ	V-Klasse (BM638) (96-03)
BA2280	ROVER	600-Serie (RH) (93-99)	BA2290	MERCEDES BENZ	VITO (BM638) (96-03)
BA2280	SUZUKI	SWIFT III (05-)	BA2291	HYUNDAI	ELANTRA (06-)
BA2280	SUZUKI	SX4 (06-)	BA2291	HYUNDAI	GETZ (02-09)
BA2281	MERCEDES BENZ	VIANO (BM639) (03-)	BA2291	HYUNDAI	GRANDEUR (99-05)
BA2281	MERCEDES BENZ	VITO (BM639) (03-)	BA2291	HYUNDAI	GRANDEUR (05-)
BA2281	MERCEDES BENZ	Transporter (BM 906) SPRINTER (06-)	BA2291	HYUNDAI	HIGHWAY VAN (00-04)
BA2281	VOLKSWAGEN	CRAFTER (06-)	BA2291	HYUNDAI	MATRIX (01-08)
BA2282	CITROEN	C2 (03-09)	BA2291	HYUNDAI	SANTA FE (SM) (01-06)
BA2282	CITROEN	C3 (02-09)	BA2291	HYUNDAI	SONATA (98-04)
BA2282	CITROEN	C3 II (09-)	BA2291	HYUNDAI	SONATA (05-)
BA2283	ALFA ROMEO	MITO (08-)	BA2291	HYUNDAI	TRAJET (00-08)
BA2283	FIAT	500 (07-)	BA2291	HYUNDAI	TUCSON (04-)
BA2283	FIAT	500C Cabrio (09-)	BA2291	HYUNDAI	XG (98-05)
BA2283	FIAT	FIORINO / FIORINO QUBO (08-)	BA2291	HYUNDAI	XG (05-)
BA2283	FIAT	GRANDE PUNTO (06-11)	BA2291	KIA	MAGENTIS (01-05)
BA2283	FIAT	LINEA (07-11)	BA2291	KIA	MAGENTIS (05-)
BA2283	FIAT	PANDA (03-)	BA2291	KIA	SPORTAGE (04-10)
BA2283	FIAT	PANDA SUV (06-)	BA2292	HYUNDAI	ACCENT II (00-05)
BA2284	DACIA	DUSTER (HS_) (10-)	BA2292	HYUNDAI	GETZ (02-09)
BA2284	DACIA	LOGAN Express (FS_) (09-)	BA2292	HYUNDAI	LANTRA/ELANTRA (95-00)
BA2284	DACIA	LOGAN MCV Kombi (KS_) (07-)	BA2293	TOYOTA	CELICA (99-05)
BA2284	DACIA	LOGAN Pick-up (US_) (08-)	BA2293	TOYOTA	COROLLA (02-04)
BA2284	NISSAN	MICRA (K12E) (03-)	BA2293	TOYOTA	COROLLA VERSO (02-04)
BA2284	NISSAN	MICRA C+C (CK12E) (05-)	BA2293	TOYOTA	PRIUS (00-03)
BA2284	NISSAN	NOTE (E11E) (06-)	BA2293	TOYOTA	PRIUS (03-)
BA2284	RENAULT	CLIO III (BR_/CR_) (05-)	BA2293	TOYOTA	YARIS (99-05)
BA2284	RENAULT	CLIO III Grandtour (KR_) (08-)	BA2293	TOYOTA	YARIS VERSO (99-05)
BA2284	RENAULT	MODUS/GRAND MODUS (JP0_) (04-)	BA2294	TOYOTA	CELICA (99-05)
BA2285	CITROEN	C8 (02-)	BA2294	TOYOTA	COROLLA (02-04)
BA2285	CITROEN	JUMPY Kombi (95-06)	BA2294	TOYOTA	COROLLA VERSO (02-04)
BA2285	CITROEN	JUMPY Kasten (95-06)	BA2294	TOYOTA	IQ (09-)
BA2285	CITROEN	JUMPY Pritsche/Fahrgestell (99-06)	BA2294	TOYOTA	MR2 (00-05)
BA2285	FIAT	SCUDO (95-06)	BA2294	TOYOTA	PRIUS (00-03)
BA2285	FIAT	ULYSSE (02-11)	BA2294	TOYOTA	PRIUS (03-)

# Neue Artikel

Nouvelles références / Codici nuovi / Novo artigos /  
Nowe artykuły / Nové výrobky

 			 		
BA2294	TOYOTA	YARIS (99-05)	BA2309	BMW	X1 (09-)
BA2294	TOYOTA	YARIS VERSO (99-05)	BA2310	MERCEDES BENZ	A-Klasse (W169 ) (04-11)
BA2295	TOYOTA	AVENSIS (03-09)	BA2310	MERCEDES BENZ	B-Klasse (W245) (05-11)
BA2295	TOYOTA	COROLLA VERSO (04-)	BA2311	BMW	1er Reihe/E81/E87 Limousine (04-11)
BA2296	CITROEN	C1 (05-)	BA2311	BMW	3er Reihe/E90 Limousine (05-)
BA2296	PEUGEOT	107 (05-)	BA2313	FORD	FOCUS II (05-11)
BA2296	TOYOTA	AYGO (05-)	BA2313	FORD	GALAXY II (06-)
BA2298	SEAT	CORDOBA III (6L2) (02-09)	BA2313	FORD	KUGA (08-)
BA2298	SEAT	IBIZA IV (6L1) (02-10)	BA2313	FORD	MONDEO IV (07-)
BA2298	SKODA	FABIA I (6Y) (99-07)	BA2313	FORD	S-MAX (06-)
BA2298	SKODA	FABIA II (5J) (07-)	BA2314	FORD	GALAXY II (06-)
BA2298	SKODA	ROOMSTER (5J) (06-)	BA2314	FORD	MONDEO IV (07-)
BA2298	VOLKSWAGEN	POLO IV (02-09)	BA2314	FORD	S-MAX (06-)
BA2299	FIAT	BRAVO (07-)	BA2314	LAND ROVER	FREELANDER 2 (FA) (07-)
BA2299	FIAT	STILO / STILO Multi Wagon (01-08)	BA2314	VOLVO	S60 II (10-)
BA2299	LANCIA	DELTA (08-)	BA2314	VOLVO	S80 II (06-)
BA2300	CITROEN	C4 I Limousine (04-)	BA2314	VOLVO	V60 (10-)
BA2300	CITROEN	C4 I Coupe (04-10)	BA2314	VOLVO	V70 III (07-)
BA2300	PEUGEOT	207 Limousine (06-)	BA2314	VOLVO	XC70 II CROSS COUNTRY (07-)
BA2300	PEUGEOT	307 Limousine (00-07)	BA2315	ALFA ROMEO	147 (01-10)
BA2300	PEUGEOT	307 Break (02-08)	BA2315	ALFA ROMEO	156 (97-05)
BA2300	PEUGEOT	307 CC (03-09)	BA2315	ALFA ROMEO	GT (04-10)
BA2300	PEUGEOT	307 SW (02-08)	BA2315	FIAT	BRAVO (95-01)
BA2301	OPEL	AGILA (08-)	BA2315	FIAT	MAREA (96-02)
BA2301	SUZUKI	SPLASH (08-)	BA2315	FIAT	MULTIPLA (98-08)
BA2301	SUZUKI	SWIFT III (05-)	BA2315	FIAT	PUNTO (03-06)
BA2302	FIAT	500 (07-)	BA2315	LANCIA	LYBRA (99-05)
BA2302	FIAT	500C Cabrio (09-)	BA2316	RENAULT	SCENIC II (JM_) (03-09)
BA2302	FORD	KA II (09-)	BA2316	RENAULT	GRAND SCENIC (JM_) (04-09)
BA2303	ALFA ROMEO	MITO (08-)	BA2317	RENAULT	CLIO III (BR_/CR_) (05-)
BA2303	FIAT	BRAVO (07-)	BA2317	RENAULT	MEGANE II Limousine 3/5-türig (BM/CM_) (02-)
BA2303	FIAT	MULTIPLA (98-08)	BA2317	RENAULT	MEGANE II Limousine 4-türig (LM_) (03-)
BA2303	FIAT	STILO / STILO Multi Wagon (01-08)	BA2317	RENAULT	MEGANE II Coupe/Cabrio (EM_) (03-)
BA2303	LANCIA	DELTA (08-)	BA2317	RENAULT	MEGANE II Grandtour (KM_) (03-)
BA2304	FORD	TRANSIT (06-)	BA2317	RENAULT	SCENIC II (JM_) (03-09)
BA2305	FORD	TRANSIT (06-)	BA2318	FORD	GALAXY I (95-06)
BA2306	FORD	TRANSIT (06-)	BA2318	SEAT	ALHAMBRA I (7V) (96-10)
BA2307	BMW	1er Reihe/E81/E87 Limousine (04-11)	BA2318	VOLKSWAGEN	SHARAN I (95-10)
BA2307	BMW	1er Reihe/E82 Coupe (07-)	BA2318	VOLKSWAGEN	TRANSPORTER (T4) (90-03)
BA2307	BMW	1er Reihe/E88 Cabrio (08-)	BA2320	OPEL	MOVANO A (98-10)
BA2307	MINI	R55 Clubman (07-)	BA2320	RENAULT	MASTER II Bus (JD/ND_) (98-06)
BA2307	MINI	R56 (06-)	BA2320	RENAULT	MASTER II Kasten (FD_) (98-06)
BA2307	MINI	R57 Cabrio (09-)	BA2320	RENAULT	MASTER II Pritsche/Fahrgestell (ED/HD/UD_) (98-06)
BA2307	MINI	R58 Coupé (11-)	BA2321	VOLKSWAGEN	TRANSPORTER (T4) (90-03)
BA2307	MINI	R59 Roadster (12-)	BA2322	VOLKSWAGEN	TRANSPORTER (T4) (90-03)
BA2308	BMW	1er Reihe/E81/E87 Limousine (04-11)	BA2323	CITROEN	JUMPER Bus (94-02)
BA2308	BMW	3er Reihe/E90 Limousine (05-)	BA2323	CITROEN	JUMPER Kasten (94-02)
BA2308	MINI	R60 Countryman (10-)	BA2323	CITROEN	JUMPER Pritsche/Fahrgestell (94-02)
BA2309	BMW	1er Reihe/E81/E87 Limousine (04-11)	BA2323	CITROEN	JUMPER (02-06)
BA2309	BMW	1er Reihe/E82 Coupe (07-)	BA2323	FIAT	DUCATO (94-02)
BA2309	BMW	1er Reihe/E88 Cabrio (08-)	BA2323	FIAT	DUCATO (02-06)
BA2309	BMW	3er Reihe/E90 Limousine (05-)	BA2323	PEUGEOT	BOXER Bus (94-02)
BA2309	BMW	3er Reihe/E91 Touring (05-)	BA2323	PEUGEOT	BOXER Kasten (94-02)
BA2309	BMW	3er Reihe/E92 Coupe (06-)	BA2323	PEUGEOT	BOXER Pritsche/Fahrgestell (94-02)
BA2309	BMW	3er Reihe/E93 Cabrio (07-)	BA2323	PEUGEOT	BOXER (02-06)





# Neue Artikel

Nouvelles références / Codici nuovi / Novo artigos /  
Nowe artykuły / Nové výrobky

 			 		
BA2324	CITROEN	JUMPER Bus (94-02)	BAE5001	Classic PKW	AUDI 80 (87-91)
BA2324	CITROEN	JUMPER Kasten (94-02)	BAE5001	Classic PKW	AUDI 90 (87-91)
BA2324	CITROEN	JUMPER Pritsche/Fahrgestell (94-02)	BAE5001	Classic PKW	VOLKSWAGEN JETTA II (84-92)
BA2324	CITROEN	JUMPER (02-06)	BAE5001	SEAT	AROSA (6H) (97-05)
BA2324	FIAT	DUCATO (94-02)	BAE5001	SEAT	CORDOBA I (93-99)
BA2324	FIAT	DUCATO (02-06)	BAE5001	SEAT	CORDOBA II (6K2) (99-02)
BA2324	PEUGEOT	BOXER Bus (94-02)	BAE5001	SEAT	CORDOBA III (6L2) (02-09)
BA2324	PEUGEOT	BOXER Kasten (94-02)	BAE5001	SEAT	IBIZA II (93-99)
BA2324	PEUGEOT	BOXER Pritsche/Fahrgestell (94-02)	BAE5001	SEAT	IBIZA III (6K1) (99-02)
BA2324	PEUGEOT	BOXER (02-06)	BAE5001	SEAT	IBIZA IV (6L1) (02-10)
BA2325	CITROEN	JUMPER Bus (94-02)	BAE5001	SEAT	IBIZA V / ST / SPORTCOUPE (08-)
BA2325	CITROEN	JUMPER Kasten (94-02)	BAE5001	SEAT	Mii (12-)
BA2325	CITROEN	JUMPER Pritsche/Fahrgestell (94-02)	BAE5001	SEAT	TOLEDO I (1L) (91-98)
BA2325	FIAT	DUCATO (94-02)	BAE5001	SKODA	CITIGO (12-)
BA2325	PEUGEOT	BOXER Bus (94-02)	BAE5001	SKODA	FABIA I (6Y) (99-07)
BA2325	PEUGEOT	BOXER Kasten (94-02)	BAE5001	SKODA	FABIA II (5J) (07-)
BA2325	PEUGEOT	BOXER Pritsche/Fahrgestell (94-02)	BAE5001	SKODA	FAVORIT (781) (87-95)
BA2326	TOYOTA	AVENSIS (03-09)	BAE5001	SKODA	FELICIA I (791/795) (95-97)
BA2326	TOYOTA	COROLLA VERSO (04-)	BAE5001	SKODA	FELICIA II (6U) (98-01)
BA2326	TOYOTA	PREVIA (05-)	BAE5001	SKODA	FELICIA PICK-UP (797) (97-00)
BA2327	VOLKSWAGEN	TRANSPORTER (T5) (03-)	BAE5001	SKODA	FORMAN (785) (91-95)
BA2328	CITROEN	JUMPER (06-)	BAE5001	SKODA	PICK-UP (93-95)
BA2328	FIAT	DUCATO (06-)	BAE5001	VOLKSWAGEN	CADDY Pickup (97-02)
BA2328	PEUGEOT	BOXER (06-)	BAE5001	VOLKSWAGEN	FOX (05-)
BA2329	CITROEN	JUMPY (07-)	BAE5001	VOLKSWAGEN	GOLF II (84-93)
BA2329	FIAT	SCUDO (07-)	BAE5001	VOLKSWAGEN	GOLF III (92-97)
BA2329	PEUGEOT	EXPERT Tepee (07-)	BAE5001	VOLKSWAGEN	GOLF III Variant (93-99)
BA2330	CITROEN	JUMPY (07-)	BAE5001	VOLKSWAGEN	GOLF III Cabriolet (94-02)
BA2330	FIAT	SCUDO (07-)	BAE5001	VOLKSWAGEN	LUPO (98-05)
BA2330	PEUGEOT	EXPERT Tepee (07-)	BAE5001	VOLKSWAGEN	PASSAT (88-93)
BA2331	TOYOTA	COROLLA (02-04)	BAE5001	VOLKSWAGEN	POLO III (95-01)
BA2331	TOYOTA	COROLLA (04-06)	BAE5001	VOLKSWAGEN	POLO IV (02-09)
BA2332	FIAT	PUNTO (93-00)	BAE5001	VOLKSWAGEN	POLO V (09-)
BA2332	FIAT	PUNTO (00-03)	BAE5001	VOLKSWAGEN	POLO Classic (96-01)
BA2332	FIAT	PUNTO (03-06)	BAE5001	VOLKSWAGEN	POLO Variant (97-01)
BA2332	LANCIA	Y (96-03)	BAE5001	VOLKSWAGEN	VENTO (92-98)
BA2333	AUDI	A3 (96-03)	BAE5001	VOLKSWAGEN	up (11-)
BA2333	AUDI	TT Coupe (98-06)	BAE5002	CITROEN	SAXO (96-04)
BA2333	AUDI	TT Roadster (99-06)	BAE5002	CITROEN	XSARA (N1) Limousine (97-05)
BA2333	SEAT	IBIZA IV (6L1) (02-10)	BAE5002	CITROEN	XSARA (N0) Coupe (97-05)
BA2333	SEAT	LEON I (1M1) (99-05)	BAE5002	CITROEN	ZX (N2) Limousine (91-97)
BA2333	SEAT	TOLEDO II (1M2) (98-04)	BAE5002	DACIA	LOGAN Express (FS_) (09-)
BA2333	SKODA	OCTAVIA I (1U) (97-10)	BAE5002	DACIA	LOGAN Limousine (LS_) (04-)
BA2333	VOLKSWAGEN	GOLF III (92-97)	BAE5002	PEUGEOT	106 (96-04)
BA2333	VOLKSWAGEN	GOLF III Variant (93-99)	BAE5002	PEUGEOT	206 Limousine (98-09)
BA2333	VOLKSWAGEN	GOLF IV (98-03)	BAE5002	PEUGEOT	206 SW (02-07)
BA2333	VOLKSWAGEN	GOLF IV Variant (99-06)	BAE5002	PEUGEOT	306 Limousine (3/5-türig) (93-01)
BA2333	VOLKSWAGEN	NEW BEETLE (98-10)	BAE5002	PEUGEOT	306 Limousine (4-türig) (94-01)
BA2333	VOLKSWAGEN	PASSAT (94-96)	BAE5002	PEUGEOT	306 Cabriolet (94-03)
BA2333	VOLKSWAGEN	VENTO (92-98)	BAE5002	RENAULT	CLIO II Limousine (BB_/CB_) (98-)
BA2334	FIAT	DOBLO (01-10)	BAE5002	RENAULT	CLIO II Kasten (SB_) (98-)
BA2335	DACIA	LOGAN MCV Kombi (KS_) (07-)	BAE5002	RENAULT	LAGUNA I Limousine (B56/556_) (93-00)
BA2335	DACIA	LOGAN Pick-up (US_) (08-)	BAE5002	RENAULT	LOGAN (LS_) (04-)
BA2335	DACIA	SANDERO (08-)	BAE5002	RENAULT	LOGAN Kombi (KS_) (04-)
BAE5001	AUDI	A2 (00-05)	BAE5002	RENAULT	SANDERO (BS_) (09-)



# Neue Artikel

Nouvelles références / Codici nuovi / Novo artigos /  
Nowe artykuły / Nové výrobky

 			 		
BAE5002	RENAULT	THALIA (LB_) (98-)	BAE5008	RENAULT	CLIO I Limousine (B/C 57_) (90-98)
BAE5002	RENAULT	TWINGO I Limousine (C06_) (93-07)	BAE5008	RENAULT	CLIO I Kasten (S 57_) (91-98)
BAE5002	RENAULT	TWINGO I Kasten (S06_) (93-07)	BAE5008	RENAULT	EXPRESS/RAPID (F40_) (85-98)
BAE5003	Classic PKW	AUDI 80 (79-81)	BAE5008	RENAULT	R19 (3/5-türig) (B53/C53/S53_) (88-95)
BAE5003	Classic PKW	AUDI 80 (82-84)	BAE5008	RENAULT	R19 CHAMADE (L53_) (89-95)
BAE5003	Classic PKW	AUDI 80 (84-87)	BAE5008	RENAULT	R19 Cabriolet (D53_) (91-96)
BAE5003	Classic PKW	AUDI COUPE (81-88)	BAE5008	RENAULT	TWINGO I Limousine (C06_) (93-07)
BAE5003	Classic PKW	VOLKSWAGEN DERBY/POLO Stufenheck (77-88)	BAE5008	RENAULT	TWINGO I Kasten (S06_) (93-07)
BAE5003	Classic PKW	VOLKSWAGEN GOLF I Cabriolet (79-93)	BAE5009	SEAT	INCA (6K9) (96-03)
BAE5003	Classic PKW	VOLKSWAGEN GOLF I (74-83)	BAE5009	SKODA	OCTAVIA I (1U) (97-10)
BAE5003	Classic PKW	VOLKSWAGEN JETTA I (79-83)	BAE5009	SKODA	ROOMSTER (5J) (06-)
BAE5003	Classic PKW	VOLKSWAGEN JETTA II (84-92)	BAE5009	VOLKSWAGEN	CADDY II (96-03)
BAE5003	Classic PKW	VOLKSWAGEN PASSAT Limousine (85-88)	BAE5010	FIAT	PUNTO (00-03)
BAE5003	Classic PKW	VOLKSWAGEN PASSAT/SANTANA Limousine (73-84)	BAE5010	FIAT	PUNTO (03-06)
BAE5003	Classic PKW	VOLKSWAGEN POLO I (75-81)	BAE5011	CHEVROLET	LANOS (05-)
BAE5003	Classic PKW	VOLKSWAGEN SCIROCCO I (74-83)	BAE5011	DAEWOO	ARANOS (95-97)
BAE5003	Classic PKW	VOLKSWAGEN SCIROCCO II (84-92)	BAE5011	DAEWOO	CIELO (94-98)
BAE5003	SEAT	AROSA (6H) (97-05)	BAE5011	DAEWOO	ESPERO (95-99)
BAE5003	SEAT	CORDOBA I (93-99)	BAE5011	DAEWOO	LANOS (97-02)
BAE5003	SEAT	IBIZA II (93-99)	BAE5011	DAEWOO	NEXIA (95-97)
BAE5003	SEAT	TOLEDO I (1L) (91-98)	BAE5011	DAEWOO	NUBIRA (97-99)
BAE5003	VOLKSWAGEN	GOLF II (84-93)	BAE5011	DAEWOO	NUBIRA (99-05)
BAE5003	VOLKSWAGEN	LUPO (98-05)	BAE5011	OPEL	ASTRA F / Vauxhall Astra MKIII (91-01)
BAE5003	VOLKSWAGEN	POLO II (81-94)	BAE5011	OPEL	ASTRA G / Vauxhall Astra MKIV (98-04)
BAE5003	VOLKSWAGEN	POLO III (95-01)	BAE5011	OPEL	VECTRA A / Vauxhall Cavalier (89-95)
BAE5003	VOLKSWAGEN	POLO Classic (96-01)	BAE5012	OPEL	ASTRA F / Vauxhall Astra MKIII (91-01)
BAE5004	FORD	ESCORT VII (95-00)	BAE5012	OPEL	ASTRA G / Vauxhall Astra MKIV (98-04)
BAE5004	FORD	FIESTA IV (96-02)	BAE5012	OPEL	VECTRA B / Vauxhall Vectra (96-02)
BAE5004	FORD	KA I (96-08)	BAE5012	OPEL	ZAFIRA I / Vauxhall Zafira I (99-05)
BAE5004	FORD	PUMA (97-01)	BAE5013	BMW	3er Reihe/E36 (91-00)
BAE5004	MAZDA	121 (96-03)	BAE5014	CITROEN	AX (86-98)
BAE5005	Classic PKW	OPEL CORSA A / Vauxhall Nova (83-92)	BAE5014	CITROEN	SAXO (96-04)
BAE5005	OPEL	ASTRA F / Vauxhall Astra MKIII (91-01)	BAE5014	PEUGEOT	106 (91-96)
BAE5005	OPEL	CORSA B / Vauxhall Corsa (93-00)	BAE5014	PEUGEOT	106 (96-04)
BAE5005	OPEL	TIGRA / Vauxhall Tigra (94-00)	BAE5015	FORD	ESCORT VII (95-00)
BAE5006	AUDI	80 (91-95)	BAE5015	FORD	FIESTA IV (96-02)
BAE5006	AUDI	100 (91-94)	BAE5016	FIAT	BRAVA (95-01)
BAE5006	Classic PKW	AUDI 100 (76-79)	BAE5016	FIAT	BRAVO (95-01)
BAE5006	Classic PKW	AUDI 100 (80-81)	BAE5016	FIAT	PUNTO (93-00)
BAE5006	Classic PKW	AUDI 100 (82)	BAE5016	LANCIA	Y (96-03)
BAE5006	Classic PKW	AUDI 100 (83-90)	BAE5017	NISSAN	KUBISTAR (X76) Kombi (03-)
BAE5006	Classic PKW	VOLKSWAGEN CADDY I (83-92)	BAE5017	RENAULT	KANGOO I (KC_) (98-07)
BAE5006	Classic PKW	VOLKSWAGEN JETTA II (84-92)	BAE5017	RENAULT	KANGOO Express/Rapid (FC_) (98-07)
BAE5006	SEAT	INCA (6K9) (96-03)	BAE5018	FORD	TRANSIT (00-06)
BAE5006	VOLKSWAGEN	CADDY II (96-03)	BAE5018	FORD	TRANSIT (06-)
BAE5006	VOLKSWAGEN	GOLF II (84-93)	BAE5019	CITROEN	BERLINGO (MF) Kombi (96-08)
BAE5006	VOLKSWAGEN	GOLF III (92-97)	BAE5019	CITROEN	BERLINGO (M_) Kasten (96-08)
BAE5006	VOLKSWAGEN	GOLF III Variant (93-99)	BAE5019	CITROEN	XSARA Picasso (N68) (00-10)
BAE5006	VOLKSWAGEN	PASSAT (88-93)	BAE5019	PEUGEOT	PARTNER Kombi (96-08)
BAE5006	VOLKSWAGEN	PASSAT (94-96)	BAE5019	PEUGEOT	PARTNER Kasten (96-08)
BAE5007	MERCEDES BENZ	A-Klasse (W168) (97-04)	BAE5020	CITROEN	AX (86-98)
BAE5008	Classic PKW	RENAULT R5 SUPER (85-96)	BAE5020	CITROEN	SAXO (96-04)
BAE5008	Classic PKW	RENAULT R9 (82-89)	BAE5020	Classic PKW	PEUGEOT 205 (83-90)
BAE5008	Classic PKW	RENAULT R11 (83-89)	BAE5020	PEUGEOT	106 (91-96)
BAE5008	Classic PKW	RENAULT R21 Limousine (B48/L48_) (86-93)	BAE5020	PEUGEOT	106 (96-04)

# Neue Artikel

Nouvelles références / Codici nuovi / Novo artigos /  
Nowe artykuły / Nové výrobky

 			 		
BAE5020	PEUGEOT	205 (91-98)	BAE5035	TOYOTA	CARINA E (92-97)
BAE5020	PEUGEOT	309 (85-93)	BAE5035	TOYOTA	CELICA (89-93)
BAE5021	FORD	FIESTA III (89-96)	BAE5035	TOYOTA	COROLLA (87-92)
BAE5022	RENAULT	MEGANE I Limousine 3/5-türig (BA/SA_) (96-02)	BAE5035	TOYOTA	COROLLA (92-97)
BAE5022	RENAULT	MEGANE I Classic (LA_) (96-02)	BAE5035	TOYOTA	COROLLA (97-02)
BAE5022	RENAULT	MEGANE I Coach (DA_) (95-03)	BAE5036	FORD	FIESTA IV (96-02)
BAE5022	RENAULT	MEGANE I Cabrio (EA_) (96-03)	BAE5036	FORD	FIESTA V (02-08)
BAE5023	CITROEN	JUMPER Bus (94-02)	BAE5036	FORD	FUSION (02-)
BAE5023	CITROEN	JUMPER Kasten (94-02)	BAE5036	FORD	KA I (96-08)
BAE5023	CITROEN	JUMPER Pritsche/Fahrgestell (94-02)	BAE5036	FORD	PUMA (97-01)
BAE5023	FIAT	DUCATO (94-02)	BAE5036	FORD	STREET KA (03-06)
BAE5023	PEUGEOT	BOXER Bus (94-02)	BAE5036	MAZDA	121 (96-03)
BAE5023	PEUGEOT	BOXER Kasten (94-02)	BAE5036	MAZDA	2 (03-07)
BAE5023	PEUGEOT	BOXER Pritsche/Fahrgestell (94-02)	BAE5036	MAZDA	DEMIO (03-)
BAE5024	VOLKSWAGEN	TRANSPORTER (T4) (90-03)	BAE5037	CITROEN	EVASION (94-02)
BAE5025	OPEL	CORSA C / Vauxhall Corsa MK II (00-06)	BAE5037	CITROEN	JUMPY Kombi (95-06)
BAE5025	OPEL	TIGRA TWIN TOP / Vau. Tigra Twin Top (04-09)	BAE5037	CITROEN	JUMPY Kasten (95-06)
BAE5026	RENAULT	LAGUNA I Grandtour (K56_) (95-00)	BAE5037	CITROEN	JUMPY Pritsche/Fahrgestell (99-06)
BAE5026	RENAULT	MEGANE I Grandtour (KA_) (98-03)	BAE5037	FIAT	SCUDO (95-06)
BAE5026	RENAULT	MEGANE SCENIC (JA_) (96-99)	BAE5037	FIAT	ULYSSE (94-02)
BAE5026	RENAULT	SCENIC I (JA_) (99-03)	BAE5037	LANCIA	ZETA (94-02)
BAE5027	MAZDA	323 Limousine/323 F (89-94)	BAE5037	PEUGEOT	806 (94-02)
BAE5027	MAZDA	323 Limousine/323 C/323 F/323 S (94-98)	BAE5037	PEUGEOT	EXPERT Kombi (95-06)
BAE5027	MAZDA	MX-3 (91-98)	BAE5037	PEUGEOT	EXPERT Kasten (95-06)
BAE5028	FORD	TRANSIT (00-06)	BAE5037	PEUGEOT	EXPERT Pritsche/Fahrgestell (95-06)
BAE5029	FIAT	MAREA (96-02)	BAE5038	FIAT	BRAVA (95-01)
BAE5029	FIAT	MULTIPLA (98-08)	BAE5038	FIAT	BRAVO (95-01)
BAE5029	FIAT	PALIO / PALIO WEEKEND EUROPA (97-06)	BAE5038	FIAT	MAREA (96-02)
BAE5030	FORD	MONDEO I (93-96)	BAE5039	FORD	FIESTA IV (96-02)
BAE5030	FORD	MONDEO II (96-00)	BAE5039	FORD	KA I (96-08)
BAE5031	FORD	MONDEO I (93-96)	BAE5039	MAZDA	121 (96-03)
BAE5031	FORD	MONDEO II (96-00)	BAE5040	SMART	CABRIO (BM450) (00-03)
BAE5032	CITROEN	JUMPER Bus (94-02)	BAE5040	SMART	CITY COUPE (BM450) (98-04)
BAE5032	CITROEN	JUMPER Kasten (94-02)	BAE5040	SMART	CROSSBLADE (BM450) (02-04)
BAE5032	CITROEN	JUMPER Pritsche/Fahrgestell (94-02)	BAE5040	SMART	FORTWO CABRIO (BM450) (04-07)
BAE5032	CITROEN	JUMPER (02-06)	BAE5040	SMART	FORTWO COUPE (BM450) (04-07)
BAE5032	FIAT	DUCATO (94-02)	BAE5040	SMART	ROADSTER (BM452) (03-05)
BAE5032	FIAT	DUCATO (02-06)	BAE5040	SMART	ROADSTER COUPE (BM452) (03-05)
BAE5032	PEUGEOT	BOXER Bus (94-02)	BAE5041	FORD	FOCUS I (98-04)
BAE5032	PEUGEOT	BOXER Kasten (94-02)	BAE5042	CITROEN	JUMPER Bus (94-02)
BAE5032	PEUGEOT	BOXER Pritsche/Fahrgestell (94-02)	BAE5042	CITROEN	JUMPER Kasten (94-02)
BAE5032	PEUGEOT	BOXER (02-06)	BAE5042	CITROEN	JUMPER Pritsche/Fahrgestell (94-02)
BAE5033	OPEL	ASTRA G / Vauxhall Astra MKIV (98-04)	BAE5042	CITROEN	JUMPY (07-)
BAE5033	OPEL	ASTRA H / GTC / Vauxhall Astra MKV (04-10)	BAE5042	FIAT	DUCATO (94-02)
BAE5033	OPEL	ASTRA H Caravan/Vau. Astra MKV Estate (04-10)	BAE5042	FIAT	SCUDO (07-)
BAE5033	OPEL	COMBO / Vauxhall Combo (01-)	BAE5042	PEUGEOT	BOXER Bus (94-02)
BAE5033	OPEL	ZAFIRA I / Vauxhall Zafira I (99-05)	BAE5042	PEUGEOT	BOXER Kasten (94-02)
BAE5034	FORD	TOURNEO (94-00)	BAE5042	PEUGEOT	BOXER Pritsche/Fahrgestell (94-02)
BAE5034	FORD	TRANSIT (95-00)	BAE5042	PEUGEOT	EXPERT Tepee (07-)
BAE5035	Classic PKW	TOYOTA CAMRY (82-86)	BAH0017	BMW	3er Reihe/E46 (98-06)
BAE5035	Classic PKW	TOYOTA CAMRY (86-91)	BAH0017	BMW	Z4 Roadster/E85 (03-08)
BAE5035	Classic PKW	TOYOTA CARINA II (83-87)	BAH0017	BMW	Z4 Coupe/E86 (06-08)
BAE5035	Classic PKW	TOYOTA CELICA (85-89)	BAH0018	MERCEDES BENZ	C-Klasse (W202) Limousine (93-00)
BAE5035	Classic PKW	TOYOTA CORONA (82-87)	BAH0018	MERCEDES BENZ	C-Klasse (S202) Kombi (96-01)
BAE5035	TOYOTA	CARINA II (87-92)	BAH0018	MERCEDES BENZ	C-Klasse (W203) Limousine (00-07)

# Neue Artikel

Nouvelles références / Codici nuovi / Novo artigos /





Nowe artykuły / Nové výrobky

 			 		
BAH0018	MERCEDES BENZ	C-Klasse (S203) Kombi (01-07)	BAH0029	FORD	PUMA (97-01)
BAH0018	MERCEDES BENZ	C-Klasse (CL203) Sportcoupe (01-08)	BAH0030	FORD	FIESTA III (89-96)
BAH0018	MERCEDES BENZ	C-Klasse (CLC203) Coupe (08-10)	BAH0031	PEUGEOT	206 Limousine (98-09)
BAH0018	MERCEDES BENZ	C-Klasse (W204) Limousine (07-)	BAH0031	PEUGEOT	206 CC (00-07)
BAH0018	MERCEDES BENZ	C-Klasse (S204) Kombi (07-)	BAH0031	PEUGEOT	206 SW (02-07)
BAH0018	MERCEDES BENZ	C-Klasse (C204) Coupe (11-)	BAH0031	PEUGEOT	206 PLUS (09-)
BAH0018	MERCEDES BENZ	CLK-Klasse (C208) Coupe (97-02)	BAH0032	FORD	FIESTA III (89-96)
BAH0018	MERCEDES BENZ	CLK-Klasse (A208) Cabrio (98-03)	BAH0033	AUDI	A1 / A1 Sportback (10-)
BAH0018	MERCEDES BENZ	CLK-Klasse (C209) Coupe (02-09)	BAH0033	AUDI	A3 (96-03)
BAH0018	MERCEDES BENZ	CLK-Klasse (A209) Cabrio (03-09)	BAH0033	AUDI	TT Coupe (98-06)
BAH0018	MERCEDES BENZ	E-Klasse (W210) Limousine (95-02)	BAH0033	AUDI	TT Roadster (99-06)
BAH0018	MERCEDES BENZ	E-Klasse (S210) Kombi (96-03)	BAH0033	SEAT	AROSA (6H) (97-05)
BAH0018	MERCEDES BENZ	E-Klasse (C207) Coupe (09-)	BAH0033	SEAT	CORDOBA II (6K2) (99-02)
BAH0018	MERCEDES BENZ	E-Klasse (A207) Cabrio (10-)	BAH0033	SEAT	CORDOBA III (6L2) (02-09)
BAH0018	MERCEDES BENZ	SLK-Klasse (R170) (96-04)	BAH0033	SEAT	IBIZA III (6K1) (99-02)
BAH0018	MERCEDES BENZ	SLK-Klasse (R171) (04-11)	BAH0033	SEAT	IBIZA IV (6L1) (02-10)
BAH0018	MERCEDES BENZ	SLK-Klasse (R172) (11-)	BAH0033	SEAT	IBIZA V / ST / SPORTCOUPE (08-)
BAH0019	SEAT	AROSA (6H) (97-05)	BAH0033	SEAT	LEON I (1M1) (99-05)
BAH0019	VOLKSWAGEN	LUPO (98-05)	BAH0033	SEAT	TOLEDO II (1M2) (98-04)
BAH0019	VOLKSWAGEN	PASSAT (94-96)	BAH0033	SKODA	FABIA I (6Y) (99-07)
BAH0019	VOLKSWAGEN	POLO III (95-01)	BAH0033	SKODA	FABIA II (5J) (07-)
BAH0020	MERCEDES BENZ	Transporter (BM 901/902) SPRINTER (95-06)	BAH0033	SKODA	OCTAVIA I (1U) (97-10)
BAH0020	MERCEDES BENZ	Transporter (BM 903/904) SPRINTER (95-06)	BAH0033	SKODA	ROOMSTER (5J) (06-)
BAH0020	VOLKSWAGEN	LT/- 4x4 (96-06)	BAH0033	VOLKSWAGEN	BORA (98-04)
BAH0021	AUDI	A4 (B6/B7) (01-08)	BAH0033	VOLKSWAGEN	FOX (05-)
BAH0021	AUDI	A4 Cabrio (02-08)	BAH0033	VOLKSWAGEN	GOLF IV (98-03)
BAH0021	SEAT	EXEO / ST (09-)	BAH0033	VOLKSWAGEN	GOLF IV Variant (99-06)
BAH0022	VOLKSWAGEN	TRANSPORTER (T4) (90-03)	BAH0033	VOLKSWAGEN	LUPO (98-05)
BAH0023	AUDI	A3 (96-03)	BAH0033	VOLKSWAGEN	NEW BEETLE (98-10)
BAH0023	SEAT	LEON I (1M1) (99-05)	BAH0033	VOLKSWAGEN	NEW BEETLE Cabriolet (03-10)
BAH0023	SEAT	TOLEDO II (1M2) (98-04)	BAH0033	VOLKSWAGEN	POLO III (95-01)
BAH0023	SKODA	OCTAVIA I (1U) (97-10)	BAH0033	VOLKSWAGEN	POLO IV (02-09)
BAH0023	VOLKSWAGEN	BORA (98-04)	BAH0033	VOLKSWAGEN	POLO V (09-)
BAH0023	VOLKSWAGEN	GOLF IV (98-03)	BAH0033	VOLKSWAGEN	POLO Classic (96-01)
BAH0023	VOLKSWAGEN	GOLF IV Variant (99-06)	BAH0033	VOLKSWAGEN	POLO Variant (97-01)
BAH0023	VOLKSWAGEN	NEW BEETLE (98-10)	BAR08106	CITROEN	SAXO (96-04)
BAH0023	VOLKSWAGEN	NEW BEETLE Cabriolet (03-10)	BAR08106	CITROEN	XSARA (N1) Limousine (97-05)
BAH0023	VOLKSWAGEN	POLO III (95-01)	BAR08106	CITROEN	XSARA (N2) Kombi (97-05)
BAH0024	Classic PKW	RENAULT R21 Limousine (B48/L48_) (86-93)	BAR08106	CITROEN	XSARA (N0) Coupe (97-05)
BAH0024	RENAULT	CLIO I Limousine (B/C 57_) (90-98)	BAR08106	CITROEN	ZX (N2) Limousine (91-97)
BAH0024	RENAULT	CLIO I Kasten (S 57_) (91-98)	BAR08106	CITROEN	ZX (N2) Kombi (93-98)
BAH0024	RENAULT	R21 NEVADA (K48_) (86-95)	BAR08106	PEUGEOT	106 (96-04)
BAH0024	RENAULT	TWINGO I Limousine (C06_) (93-07)	BAR08106	PEUGEOT	206 Limousine (98-09)
BAH0024	RENAULT	TWINGO I Kasten (S06_) (93-07)	BAR08106	PEUGEOT	206 CC (00-07)
BAH0025	BMW	5er Reihe/E39 (96-03)	BAR08106	PEUGEOT	206 SW (02-07)
BAH0026	AUDI	100 (91-94)	BAR08106	PEUGEOT	306 Limousine (3/5-türig) (93-01)
BAH0026	AUDI	100 Quattro (91-94)	BAR08106	PEUGEOT	306 Limousine (4-türig) (94-01)
BAH0026	AUDI	A6 / A6 Avant (4A/C4) (94-97)	BAR08106	PEUGEOT	306 Cabriolet (94-03)
BAH0027	FORD	GALAXY I (95-06)	BAR08106	PEUGEOT	306 Kombi (97-02)
BAH0027	SEAT	ALHAMBRA I (7V) (96-10)	BAR09118	Classic PKW	MERCEDES BENZ (W124) E-Klasse (85-93)
BAH0027	VOLKSWAGEN	SHARAN I (95-10)	BAR09118	Classic PKW	MERCEDES BENZ (W201) 190-190 E26 (82-93)
BAH0028	MERCEDES BENZ	C-Klasse (W202) Limousine (93-00)	BAR09118	MERCEDES BENZ	E-Klasse (W124) (93-97)
BAH0028	MERCEDES BENZ	CL-Klasse (C140) Coupe (96-99)	BAR09120	MERCEDES BENZ	C-Klasse (W202) Limousine (93-00)
BAH0028	MERCEDES BENZ	S-Klasse (W140) (93-98)	BAR09122	CITROEN	XANTIA (X1) Limousine (93-97)
BAH0029	FORD	FIESTA IV (96-02)	BAR09122	CITROEN	XANTIA (X2) Limousine (98-03)



# Neue Artikel

Nouvelles références / Codici nuovi / Novo artigos /  
Nowe artykuły / Nové výrobky

 			 		
BAR09122	CITROEN	XANTIA (X2) Kombi (98-03)	BAR10203	VOLKSWAGEN	PASSAT (88-93)
BAR09124	SEAT	AROSA (6H) (97-05)	BAR10203	VOLKSWAGEN	PASSAT (94-96)
BAR09124	SEAT	CORDOBA II (6K2) (99-02)	BAR10203	VOLKSWAGEN	VENTO (92-98)
BAR09124	SEAT	IBIZA II (93-99)	BAR10204	OPEL	ASTRA F / Vauxhall Astra MKIII (91-01)
BAR09124	SEAT	IBIZA III (6K1) (99-02)	BAR10204	OPEL	VECTRA A / Vauxhall Cavalier (89-95)
BAR09124	VOLKSWAGEN	LUPO (98-05)	BAR10205	OPEL	CALIBRA / Vauxhall Calibra (89-97)
BAR09124	VOLKSWAGEN	POLO III (95-01)	BAR10205	OPEL	VECTRA A / Vauxhall Cavalier (89-95)
BAR09124	VOLKSWAGEN	POLO Classic (96-01)	BAR10211	BMW	3er Reihe/E36 (91-00)
BAR09124	VOLKSWAGEN	POLO Variant (97-01)	BAR10215	NISSAN	ALMERA (N16) (00-06)
BAR09133	AUDI	A3 (96-03)	BAR10215	NISSAN	PRIMERA (P10E) Limousine (90-96)
BAR09133	AUDI	TT Coupe (98-06)	BAR10215	NISSAN	PRIMERA (P11E) Limousine (96-02)
BAR09133	AUDI	TT Roadster (99-06)	BAR10215	NISSAN	PRIMERA (W11) Kombi (98-02)
BAR09133	SKODA	OCTAVIA I (1U) (97-10)	BAR10219	RENAULT	LAGUNA I Limousine (B56/556_) (93-00)
BAR09133	VOLKSWAGEN	BORA (98-04)	BAR10219	RENAULT	LAGUNA I Grandtour (K56_) (95-00)
BAR09133	VOLKSWAGEN	GOLF IV (98-03)	BAR10219	RENAULT	SAFRANE (B54_) (92-00)
BAR09133	VOLKSWAGEN	GOLF IV Variant (99-06)	BAR10224	AUDI	A4 (B5) (95-01)
BAR09138	TOYOTA	COROLLA (02-04)	BAR10224	VOLKSWAGEN	PASSAT (97-05)
BAR09138	TOYOTA	COROLLA (04-06)	BAR10227	BMW	5er Reihe/E39 (96-03)
BAR09139	TOYOTA	COROLLA (02-04)	BAR10228	MERCEDES BENZ	V-Klasse (BM638) (96-03)
BAR09139	TOYOTA	COROLLA VERSO (02-04)	BAR10228	MERCEDES BENZ	VITO (BM638) (96-03)
BAR09139	TOYOTA	PRIUS (00-03)	BAR10229	MITSUBISHI	CARISMA (95-06)
BAR09139	TOYOTA	YARIS (99-05)	BAR10229	MITSUBISHI	SPACE STAR (98-06)
BAR09139	TOYOTA	YARIS VERSO (99-05)	BAR10229	VOLVO	S40 I (95-03)
BAR10185	Classic PKW	MERCEDES BENZ (R107) 280 SL-560 SL (71-89)	BAR10229	VOLVO	V40 (95-04)
BAR10185	Classic PKW	MERCEDES BENZ (R113) 230 SL-280 SL (63-71)	BAR10230	PEUGEOT	406 Limousine (95-04)
BAR10185	Classic PKW	MERCEDES BENZ (W108) 250 S-300 SEb (65-72)	BAR10230	PEUGEOT	406 Kombi (96-04)
BAR10185	Classic PKW	MERCEDES BENZ (W109) 300 SEL (65-72)	BAR10230	PEUGEOT	406 Coupe (97-05)
BAR10185	Classic PKW	MERCEDES BENZ (W111) 220-280 (59-71)	BAR10258	AUDI	A6 / A6 Avant (4B/C5) (97-05)
BAR10185	Classic PKW	MERCEDES BENZ (W114) 230.6-280 CE (67-76)	BAR10259	AUDI	A6 / A6 Avant (4B/C5) (97-05)
BAR10185	Classic PKW	MERCEDES BENZ (W115) 200-240 D 3,0 (67-76)	BAR10260	AUDI	A6 / A6 Avant (4B/C5) (97-05)
BAR10185	Classic PKW	MERCEDES BENZ (W116) 280 S-450 SEL 6,9 (72-80)	BAR10260	AUDI	A6 Allroad (00-05)
BAR10185	Classic PKW	MERCEDES BENZ (W123) 200-300 TD Turbo (76-85)	BAR10273	BMW	Z3 (95-02)
BAR10185	Classic PKW	MERCEDES BENZ (W126) 260 SE-560 SEC (80-91)	BAR10278	MERCEDES BENZ	CLS-Klasse (C218) Coupe (10-)
BAR10189	Classic PKW	VOLVO 240 Kombi (74-93)	BAR10278	MERCEDES BENZ	E-Klasse (W211) Limousine (02-09)
BAR10189	Classic PKW	VOLVO 240 Limousine (74-93)	BAR10278	MERCEDES BENZ	E-Klasse (S211) Kombi (03-09)
BAR10189	Classic PKW	VOLVO 260 Coupe (77-78)	BAR10278	MERCEDES BENZ	E-Klasse (W212) Limousine (09-)
BAR10189	Classic PKW	VOLVO 260 Kombi (75-82)	BAR10278	MERCEDES BENZ	E-Klasse (S212) Kombi (09-)
BAR10189	Classic PKW	VOLVO 260 Limousine (74-82)	BAR10280	MERCEDES BENZ	VIANO (BM639) (03-)
BAR10189	Classic PKW	VOLVO 740 Kombi (85-92)	BAR10280	MERCEDES BENZ	VITO (BM639) (03-)
BAR10189	Classic PKW	VOLVO 740 Limousine (83-92)	BAR10285	NISSAN	ALMERA TINO (V10M) (00-05)
BAR10189	Classic PKW	VOLVO 760 Kombi (82-92)	BAR10285	NISSAN	PRIMERA (P12E) Limousine (02-08)
BAR10189	Classic PKW	VOLVO 760 Limousine (82-92)	BAR10285	NISSAN	PRIMERA (W12) Kombi (02-08)
BAR10189	VOLVO	940 I Limousine (90-95)	BAR10304	MITSUBISHI	COLT (04-)
BAR10189	VOLVO	940 I Kombi (90-95)	BAR10304	MITSUBISHI	COLT CZC Cabriolet (06-08)
BAR10189	VOLVO	940 II Limousine (95-98)	BAR10304	SMART	FORFOUR (BM454) (04-06)
BAR10189	VOLVO	940 II Kombi (95-98)	BAR11115	Classic PKW	LADA NOVA (2104/2105) (75-96)
BAR10189	VOLVO	960 I Limousine (90-94)	BAR11115	Classic PKW	LADA 1200-1600 (2101/2102/2103/2106) (73-86)
BAR10189	VOLVO	960 I Kombi (90-94)	BAR11115	LADA	TOSCANA (2107) (83-96)
BAR10189	VOLVO	960 II Limousine (94-96)	BAR11151	RENAULT	AVANTIME (01-03)
BAR10189	VOLVO	960 II Kombi (94-96)	BAR11151	RENAULT	ESPACE III (JE_) (96-02)
BAR10191	Classic PKW	OPEL OMEGA A / Vauxhall Carlton (87-93)	BAR12124	BMW	5er Reihe/E34 (88-96)
BAR10191	Classic PKW	OPEL SENATOR B / Vauxhall Royal (88-93)	BAR12125	LADA	110 Stufenheck (2110) (95-07)
BAR10203	Classic PKW	VOLKSWAGEN CORRADO (88-95)	BAR12125	LADA	111 Kombi (2111) (95-08)
BAR10203	SEAT	TOLEDO I (1L) (91-98)	BAR12125	LADA	112 Fließheck (2112) (95-08)
BAR10203	VOLKSWAGEN	GOLF III (92-97)	BAR12125	LADA	FORMA (2108) (89-95)

# Neue Artikel

Nouvelles références / Codici nuovi / Novo artigos /  
Nowe artykuły / Nové výrobky

 			 		
BAR12125	LADA	SAMARA (2108/2109) (86-99)	BAR18107	NISSAN	100 NX (B13) (90-94)
BAR12131	OPEL	OMEGA B / Vauxhall Omega (94-03)	BAR18107	NISSAN	SUNNY (N14) Limousine (90-95)
BAR12137	NISSAN	MICRA (K11E) (92-02)	BAR18107	NISSAN	SUNNY (Y10) Kombi (90-00)
BAR12142	MERCEDES BENZ	Transporter (BM 901/902) SPRINTER (95-06)	BAR18108	CITROEN	JUMPER Bus (94-02)
BAR12142	VOLKSWAGEN	LT/- 4x4 (96-06)	BAR18108	CITROEN	JUMPER Kasten (94-02)
BAR12144	MERCEDES BENZ	A-Klasse (W168) (97-04)	BAR18108	CITROEN	JUMPER Pritsche/Fahrgestell (94-02)
BAR12149	MERCEDES BENZ	E-Klasse (S210) Kombi (96-03)	BAR18108	FIAT	DUCATO (94-02)
BAR12157	FIAT	CROMA (05-10)	BAR18108	PEUGEOT	BOXER Bus (94-02)
BAR12157	OPEL	SIGNUM / Vauxhall Signum (03-08)	BAR18108	PEUGEOT	BOXER Kasten (94-02)
BAR12157	OPEL	VECTRA C (F68,F69)/Vau. Vectra MK II (02-08)	BAR18108	PEUGEOT	BOXER Pritsche/Fahrgestell (94-02)
BAR12157	OPEL	VECTRA C Caravan (F35) / Vau. MK II (03-08)	BAR18113	MAZDA	121 (91-96)
BAR12157	SAAB	9-3 Limousine (YS3F) (03-)	BAR18113	MAZDA	323 Limousine/323 F (89-94)
BAR12157	SAAB	9-3 SportCombi (05-)	BAR18113	MAZDA	323 Limousine/323 C/323 F/323 S (94-98)
BAR12157	SAAB	9-3 Cabriolet (YS3F) (03-)	BAR18113	MAZDA	MX-5 (89-98)
BAR12157	SAAB	9-3 X (09-)	BAR18124	TOYOTA	STARLET (89-96)
BAR12184	FIAT	GRANDE PUNTO (06-11)	BAR18124	TOYOTA	STARLET (96-99)
BAR12184	OPEL	CORSA D / Vauxhall Corsa MK III (06-)	BAR19109	HYUNDAI	ACCENT I (94-99)
BAR13137	Classic PKW	MERCEDES BENZ (W114) 230.6-280 CE (67-76)	BAR19109	HYUNDAI	PONY/EXCEL (89-94)
BAR13137	Classic PKW	MERCEDES BENZ (W115) 200-240 D 3,0 (67-76)	BAR19109	HYUNDAI	PONY/EXCEL (94-95)
BAR13137	Classic PKW	MERCEDES BENZ (W123) 200-300 TD Turbo (76-85)	BAR19109	HYUNDAI	S-COUPE (90-96)
BAR13160	Classic PKW	AUDI 80 (87-91)	BAR20114	VOLKSWAGEN	LT/- 4x4 (75-96)
BAR13160	Classic PKW	AUDI 80 Quattro (87-91)	BAR20126	Classic PKW	RENAULT ESPACE I (J/S 11_) (84-90)
BAR13160	Classic PKW	AUDI 90 (87-91)	BAR20126	Classic PKW	RENAULT FUEGO (80-92)
BAR13160	Classic PKW	AUDI 100 (76-79)	BAR20126	Classic PKW	RENAULT R18 Limousine (78-86)
BAR13160	Classic PKW	AUDI 100 (80-81)	BAR20126	Classic PKW	RENAULT R18 Variable (79-86)
BAR13160	Classic PKW	AUDI 100 (82)	BAR20126	Classic PKW	RENAULT R25 (84-92)
BAR13160	Classic PKW	AUDI 100 (83-90)	BAR20126	RENAULT	ESPACE II (J/S 63_) (91-96)
BAR13166	AUDI	80 (91-95)	BAR20155	CITROEN	EVASION (94-02)
BAR13167	Classic PKW	BMW 3er Reihe/E30 (82-93)	BAR20155	CITROEN	JUMPY Kombi (95-06)
BAR13182	SKODA	FAVORIT (781) (87-95)	BAR20155	CITROEN	JUMPY Kasten (95-06)
BAR13182	SKODA	FELICIA I (791/795) (95-97)	BAR20155	FIAT	SCUDO (95-06)
BAR13182	SKODA	FELICIA II (6U) (98-01)	BAR20155	FIAT	ULYSSE (94-02)
BAR13182	SKODA	FELICIA PICK-UP (797) (97-00)	BAR20155	PEUGEOT	806 (94-02)
BAR13182	SKODA	FORMAN (785) (91-95)	BAR20155	PEUGEOT	EXPERT Kombi (95-06)
BAR13182	SKODA	PICK-UP (93-95)	BAR20155	PEUGEOT	EXPERT Kasten (95-06)
BAR13182	VOLKSWAGEN	CADDY Pickup (97-02)	BAR20171	OPEL	OMEGA B / Vauxhall Omega (94-03)
BAR13184	CITROEN	BERLINGO (MF) Kombi (96-08)	BAR20183	BMW	5er Reihe/E60 Limousine (03-10)
BAR13184	CITROEN	BERLINGO (M_) Kasten (96-08)	BAR20183	BMW	5er Reihe/E61 Touring (04-10)
BAR13184	CITROEN	C2 (03-09)	BAR20183	BMW	6er Reihe/E63 Coupe (04-11)
BAR13184	CITROEN	C3 (02-09)	BAR20183	BMW	6er Reihe/E64 Cabrio (04-11)
BAR13184	CITROEN	C3 II (09-)	BAR22100	Classic PKW	VOLKSWAGEN CORRADO (88-95)
BAR13184	PEUGEOT	PARTNER Kombi (96-08)	BAR22100	SEAT	TOLEDO I (1L) (91-98)
BAR13184	PEUGEOT	PARTNER Kasten (96-08)	BAR22100	VOLKSWAGEN	GOLF III (92-97)
BAR16100	Classic PKW	MERCEDES BENZ Transporter (BM 601) 207 D-210 D	BAR22100	VOLKSWAGEN	PASSAT (88-93)
BAR16100	Classic PKW	MERCEDES BENZ Transporter (BM 602) 307 D-310 D	BAR22100	VOLKSWAGEN	PASSAT (94-96)
BAR16100	Classic PKW	MERCEDES BENZ Transporter (BM 611) 407 D-410 D	BAR22100	VOLKSWAGEN	VENTO (92-98)
BAR16100	Classic PKW	MERCEDES BENZ Transporter (BM 667) 507 D-510	BAR22103	BMW	5er Reihe/E34 (88-96)
BAR16105	Classic PKW	ALFA ROMEO AR 6 (85-89)	BAR22103	BMW	7er Reihe/E32 (86-94)
BAR16105	Classic PKW	CITROEN C25 (81-94)	BAR22108	AUDI	80 (91-95)
BAR16105	Classic PKW	FIAT DUCATO (81-93)	BAR22108	AUDI	80 Quattro (92-95)
BAR16105	Classic PKW	PEUGEOT J5 (81-94)	BAR22108	AUDI	CABRIO (91-00)
BAR16105	FIAT	TALENTO (88-94)	BAR22108	AUDI	COUPE (89-96)
BAR18107	Classic PKW	NISSAN SUNNY (B12) Coupe (86-90)	BAR22108	AUDI	COUPE Quattro (87-96)
BAR18107	Classic PKW	NISSAN SUNNY (B12) Kombi (86-90)	BAR22122	Classic PKW	BMW 3er Reihe/E30 (82-93)
BAR18107	Classic PKW	NISSAN SUNNY (N13) (86-90)	BAR22122	Classic PKW	BMW Z1 (88-91)

# Neue Artikel

Nouvelles références / Codici nuovi / Novo artigos /  
Nowe artykuły / Nové výrobky

 			 		
BAR22132	MERCEDES BENZ	C-Klasse (W202) Limousine (93-00)	BAR22197	LANCIA	YPSILON (11-)
BAR22132	MERCEDES BENZ	C-Klasse (S202) Kombi (96-01)	BAR22197	PEUGEOT	BIPPER (08-)
BAR22147	ALFA ROMEO	155 (92-97)	BAR22206	MG	ZT Limousine (01-05)
BAR22147	Classic PKW	LANCIA DELTA (86-93)	BAR22206	MG	ZT-T Kombi (01-05)
BAR22147	Classic PKW	LANCIA THEMA (89-92)	BAR22206	ROVER	75-Serie (RJ) (99-04)
BAR22147	FIAT	500 (07-)	BAR22206	ROVER	75 Serie (RX) (04-)
BAR22147	FIAT	500C Cabrio (09-)	BAR22209	BMW	3er Reihe/E46 (98-06)
BAR22147	FIAT	BRAVO (95-01)	BAR22211	VOLKSWAGEN	TRANSPORTER (T5) (03-)
BAR22147	FIAT	BRAVO (07-)	BAR24103	Classic PKW	RENAULT R20 (76-84)
BAR22147	FIAT	COUPE (94-00)	BAR24103	Classic PKW	RENAULT R30 (75-84)
BAR22147	FIAT	CROMA (91-96)	BAR24103	Classic PKW	RENAULT TRAFIC I Bus (T5/T6/T7) (80-89)
BAR22147	FIAT	DOBLO (01-10)	BAR24103	Classic PKW	RENAULT TRAFIC I Kasten (T1/T2/T3/T4) (80-89)
BAR22147	FIAT	FIORINO / FIORINO QUBO (08-)	BAR24103	Classic PKW	RENAULT TRAFIC I PROPULSION (PXX) (81-89)
BAR22147	FIAT	IDEA (04-)	BAR24103	OPEL	ARENA (97-01)
BAR22147	FIAT	LINEA (07-11)	BAR24103	RENAULT	TRAFIC I Propulsion (PXX) (89-97)
BAR22147	FIAT	MAREA (96-02)	BAR24103	RENAULT	TRAFIC I Kasten (TXX) (89-01)
BAR22147	FIAT	STILO / STILO Multi Wagon (01-08)	BAR24103	RENAULT	TRAFIC I Bus (TXW) (89-01)
BAR22147	LANCIA	DEDRA (94-99)	BAR24112	Classic PKW	FORD ESCORT / ORION (81-85)
BAR22147	LANCIA	DELTA (94-99)	BAR24112	Classic PKW	FORD ESCORT / ORION (86-90)
BAR22147	LANCIA	DELTA (08-)	BAR24112	Classic PKW	FORD SIERRA (82-86)
BAR22147	LANCIA	LYBRA (99-05)	BAR24112	Classic PKW	FORD SIERRA (87-93)
BAR22147	LANCIA	MUSA (04-)	BAR24136	Classic PKW	MITSUBISHI SAPPORO (87-90)
BAR22147	LANCIA	THEMA (92-94)	BAR24136	HYUNDAI	SANTAMO (98-02)
BAR22162	MERCEDES BENZ	V-Klasse (BM638) (96-03)	BAR24136	KIA	JOICE (00-03)
BAR22162	MERCEDES BENZ	VITO (BM638) (96-03)	BAR24136	MITSUBISHI	CARISMA (95-06)
BAR22163	AUDI	A3 (96-03)	BAR24136	MITSUBISHI	GALANT (4-türig) (87-92)
BAR22163	AUDI	TT Coupe (98-06)	BAR24136	MITSUBISHI	GALANT (5-türig) (88-92)
BAR22163	AUDI	TT Roadster (99-06)	BAR24136	MITSUBISHI	GALANT (92-96)
BAR22163	SEAT	LEON I (1M1) (99-05)	BAR24136	MITSUBISHI	GALANT (96-03)
BAR22163	SEAT	TOLEDO II (1M2) (98-04)	BAR24136	MITSUBISHI	LANCER Kombi (92-96)
BAR22163	SKODA	OCTAVIA I (1U) (97-10)	BAR24136	MITSUBISHI	SANTAMO (99-03)
BAR22163	VOLKSWAGEN	BORA (98-04)	BAR24136	MITSUBISHI	SPACE RUNNER (91-99)
BAR22163	VOLKSWAGEN	GOLF IV (98-03)	BAR24136	MITSUBISHI	SPACE STAR (98-06)
BAR22163	VOLKSWAGEN	GOLF IV Variant (99-06)	BAR24136	MITSUBISHI	SPACE WAGON (91-98)
BAR22163	VOLKSWAGEN	NEW BEETLE (98-10)	BAR24136	VOLVO	S40 I (95-03)
BAR22168	MERCEDES BENZ	A-Klasse (W168) (97-04)	BAR24136	VOLVO	V40 (95-04)
BAR22196	MERCEDES BENZ	Transporter (BM 903/904) SPRINTER (95-06)	BAR24138	CITROEN	JUMPER Bus (94-02)
BAR22196	VOLKSWAGEN	LT/- 4x4 (96-06)	BAR24138	CITROEN	JUMPER Kasten (94-02)
BAR22197	ALFA ROMEO	MITO (08-)	BAR24138	CITROEN	JUMPER Pritsche/Fahrgestell (94-02)
BAR22197	CITROEN	NEMO (08-)	BAR24138	CITROEN	JUMPER (02-06)
BAR22197	FIAT	500 (07-)	BAR24138	CITROEN	JUMPER (06-)
BAR22197	FIAT	500C Cabrio (09-)	BAR24138	FIAT	DUCATO (94-02)
BAR22197	FIAT	BRAVO (07-)	BAR24138	FIAT	DUCATO (02-06)
BAR22197	FIAT	DOBLO (01-10)	BAR24138	FIAT	DUCATO (06-)
BAR22197	FIAT	FIORINO / FIORINO QUBO (08-)	BAR24138	PEUGEOT	BOXER Bus (94-02)
BAR22197	FIAT	IDEA (04-)	BAR24138	PEUGEOT	BOXER Kasten (94-02)
BAR22197	FIAT	LINEA (07-11)	BAR24138	PEUGEOT	BOXER Pritsche/Fahrgestell (94-02)
BAR22197	FIAT	PANDA (03-)	BAR24138	PEUGEOT	BOXER (02-06)
BAR22197	FIAT	PANDA SUV (06-)	BAR24138	PEUGEOT	BOXER (06-)
BAR22197	FIAT	PANDA (12-)	BAR24139	PEUGEOT	406 Limousine (95-04)
BAR22197	FIAT	PUNTO (00-03)	BAR24139	PEUGEOT	406 Kombi (96-04)
BAR22197	FIAT	STILO / STILO Multi Wagon (01-08)	BAR24146	HYUNDAI	SANTAMO (98-02)
BAR22197	LANCIA	DEDRA (94-99)	BAR24146	KIA	JOICE (00-03)
BAR22197	LANCIA	MUSA (04-)	BAR24146	MITSUBISHI	SANTAMO (99-03)
BAR22197	LANCIA	YPSILON (03-11)	BAR24146	MITSUBISHI	SPACE RUNNER (91-99)

# Neue Artikel

Nouvelles références / Codici nuovi / Novo artigos /  
Nowe artykuły / Nové výrobky

 			 		
BAR24146	MITSUBISHI	SPACE WAGON (91-98)	BAR25162	FORD	FOCUS C-MAX (03-07)
BAR24159	MITSUBISHI	CARISMA (95-06)	BAR25162	FORD	KUGA (08-)
BAR24159	VOLVO	S40 I (95-03)	BAR25162	VOLVO	C30 Coupe (06-)
BAR24159	VOLVO	V40 (95-04)	BAR25162	VOLVO	C70 II Cabrio (06-)
BAR24162	OPEL	MOVANO A (98-10)	BAR25162	VOLVO	S40 II (04-)
BAR24162	RENAULT	MASTER II Bus (JD/ND_) (98-06)	BAR25162	VOLVO	V50 (04-)
BAR24162	RENAULT	MASTER II Kasten (FD_) (98-06)	BAR26102	VOLVO	850 Limousine (91-96)
BAR24162	RENAULT	MASTER II Pritsche/Fahrgestell (ED/HD/UD_) (98-06)	BAR26102	VOLVO	850 Kombi (92-96)
BAR24164	MAZDA	323 Limousine/323 F/323 P/323 S (98-03)	BAR26102	VOLVO	960 II Limousine (94-96)
BAR24166	OPEL	COMBO / Vauxhall Combo (01-)	BAR26102	VOLVO	960 II Kombi (94-96)
BAR24166	OPEL	CORSA C / Vauxhall Corsa MK II (00-06)	BAR26102	VOLVO	C70 Coupe (97-02)
BAR24166	OPEL	MERIVA A / Vauxhall Meriva A (02-10)	BAR26102	VOLVO	C70 I Cabrio (98-06)
BAR24166	OPEL	TIGRA TWIN TOP / Vau. Tigra Twin Top (04-09)	BAR26102	VOLVO	S70 (97-00)
BAR24170	MITSUBISHI	GALANT (96-03)	BAR26102	VOLVO	S90 (97-98)
BAR24171	RENAULT	ESPACE III (JE_) (96-02)	BAR26102	VOLVO	V70 I (97-00)
BAR24171	RENAULT	LAGUNA I Limousine (B56/556_) (93-00)	BAR26102	VOLVO	V90 (97-98)
BAR24171	RENAULT	LAGUNA I Grandtour (K56_) (95-00)	BAR26104	CITROEN	EVASION (94-02)
BAR24171	RENAULT	SAFRANE (B54_) (92-00)	BAR26104	CITROEN	JUMPY Kombi (95-06)
BAR24171	RENAULT	SCENIC I (JA_) (99-03)	BAR26104	CITROEN	JUMPY Kasten (95-06)
BAR24181	BMW	5er Reihe/E60 Limousine (03-10)	BAR26104	CITROEN	JUMPY Pritsche/Fahrgestell (99-06)
BAR24181	BMW	5er Reihe/E61 Touring (04-10)	BAR26104	FIAT	SCUDO (95-06)
BAR24192	MITSUBISHI	COLT (04-)	BAR26104	FIAT	ULYSSE (94-02)
BAR24192	MITSUBISHI	COLT CZC Cabriolet (06-08)	BAR26104	LANCIA	ZETA (94-02)
BAR24192	SMART	FORFOUR (BM454) (04-06)	BAR26104	PEUGEOT	806 (94-02)
BAR25115	VOLKSWAGEN	PASSAT (97-05)	BAR26104	PEUGEOT	EXPERT Kombi (95-06)
BAR25124	TOYOTA	CARINA E (92-97)	BAR26104	PEUGEOT	EXPERT Kasten (95-06)
BAR25124	TOYOTA	CELICA (93-99)	BAR26104	PEUGEOT	EXPERT Pritsche/Fahrgestell (95-06)
BAR25124	TOYOTA	CELICA (99-05)	BAR26105	Classic PKW	VOLVO 740 Kombi (85-92)
BAR25138	BMW	3er Reihe/E46 (98-06)	BAR26105	Classic PKW	VOLVO 740 Limousine (83-92)
BAR25138	BMW	Z4 Roadster/E85 (03-08)	BAR26105	VOLVO	940 I Limousine (90-95)
BAR25138	BMW	Z4 Coupe/E86 (06-08)	BAR26105	VOLVO	940 I Kombi (90-95)
BAR25141	FIAT	CROMA (05-10)	BAR26105	VOLVO	940 II Limousine (95-98)
BAR25141	OPEL	SIGNUM / Vauxhall Signum (03-08)	BAR26105	VOLVO	940 II Kombi (95-98)
BAR25141	OPEL	VECTRA C (F68,F69)/Vau. Vectra MK II (02-08)	BAR26105	VOLVO	960 I Limousine (90-94)
BAR25141	OPEL	VECTRA C Caravan (F35) / Vau. MK II (03-08)	BAR26105	VOLVO	960 I Kombi (90-94)
BAR25141	SAAB	9-3 Limousine (YS3F) (03-)	BAR26105	VOLVO	960 II Limousine (94-96)
BAR25141	SAAB	9-3 SportCombi (05-)	BAR26105	VOLVO	960 II Kombi (94-96)
BAR25141	SAAB	9-3 Cabriolet (YS3F) (03-)	BAR26106	CITROEN	XANTIA (X1) Limousine (93-97)
BAR25141	SAAB	9-3 X (09-)	BAR26106	CITROEN	XANTIA (X1) Kombi (95-97)
BAR25142	OPEL	ASTRA G / Vauxhall Astra MKIV (98-04)	BAR26106	CITROEN	XANTIA (X2) Limousine (98-03)
BAR25142	OPEL	ASTRA H / GTC / Vauxhall Astra MKV (04-10)	BAR26106	CITROEN	XANTIA (X2) Kombi (98-03)
BAR25142	OPEL	ASTRA H Caravan/Vau. Astra MKV Estate (04-10)	BAR26106	PEUGEOT	406 Limousine (95-04)
BAR25142	OPEL	ASTRA H TwinTop (06-)	BAR26106	PEUGEOT	406 Kombi (96-04)
BAR25142	OPEL	CORSA D / Vauxhall Corsa MK III (06-)	BAR26106	PEUGEOT	406 Coupe (97-05)
BAR25142	OPEL	MERIVA A / Vauxhall Meriva A (02-10)	BAR26108	NISSAN	SERENAVANETTE CARGO (C23M/963) (92-01)
BAR25142	OPEL	MERIVA B (10-)	BAR26109	FORD	MAVERICK (93-96)
BAR25142	OPEL	VECTRA B / Vauxhall Vectra (96-02)	BAR26109	FORD	MAVERICK (97-98)
BAR25142	OPEL	ZAFIRA I / Vauxhall Zafira I (99-05)	BAR26109	NISSAN	PICK-UP (D22) (98-07)
BAR25142	OPEL	ZAFIRA II / Vauxhall Zafira II (05-11)	BAR26109	NISSAN	TERRANO I (WD21) (87-97)
BAR25142	SAAB	9-5 Limousine (YS3E) (97-10)	BAR26109	NISSAN	TERRANO II (R20) (93-06)
BAR25142	SAAB	9-5 Kombi (YS3E) (98-10)	BAR26116	MERCEDES BENZ	M-Klasse (W163) (98-05)
BAR25162	FORD	C-MAX (07-10)	BAR26122	VOLVO	S60 I (00-09)
BAR25162	FORD	C-MAX / GRAND C-MAX (10-)	BAR26122	VOLVO	S80 I (98-06)
BAR25162	FORD	FOCUS II (05-11)	BAR26122	VOLVO	V70 II (00-07)
BAR25162	FORD	FOCUS III (11-)	BAR26122	VOLVO	XC70 I CROSS COUNTRY (00-07)





# Neue Artikel

Nouvelles références / Codici nuovi / Novo artigos /  
Nowe artykuły / Nové výrobky

 			 		
BAR26138	TOYOTA	AVENSIS (03-09)	BAV1002	Classic PKW	BMW 3er Reihe/E30 (82-93)
BAR26138	TOYOTA	COROLLA VERSO (04-)	BAV1002	Classic PKW	BMW Z1 (88-91)
BAR28101	BMW	5er Reihe/E34 (88-96)	BAV1003	BMW	5er Reihe/E34 (88-96)
BAR28101	BMW	7er Reihe/E32 (86-94)	BAV1003	BMW	7er Reihe/E32 (86-94)
BAR28102	Classic PKW	MERCEDES BENZ (W126) 260 SE-560 SEC (80-91)	BAV1003	BMW	8er Reihe/E31 (90-99)
BAR28123	VOLVO	S60 I (00-09)	BAV1003	Classic PKW	BMW 5er Reihe/E28 (81-87)
BAR28123	VOLVO	S80 I (98-06)	BAV1003	Classic PKW	BMW 6er Reihe/E24 (76-89)
BAR28123	VOLVO	V70 II (00-07)	BAV1004	Classic PKW	MERCEDES BENZ (R107) 280 SL-560 SL (71-89)
BAR28123	VOLVO	XC70 I CROSS COUNTRY (00-07)	BAV1004	Classic PKW	MERCEDES BENZ (R129) SL-Klasse (89-93)
BAR28129	NISSAN	INTERSTAR (X70) (02-)	BAV1004	Classic PKW	MERCEDES BENZ (W116) 280 S-450 SEL 6,9 (72-80)
BAR28129	OPEL	MOVANO A (98-10)	BAV1004	Classic PKW	MERCEDES BENZ (W123) 200-300 TD Turbo (76-85)
BAR28129	RENAULT	MASTER II Bus (JD/ND_) (98-06)	BAV1004	Classic PKW	MERCEDES BENZ (W124) E-Klasse (85-93)
BAR28129	RENAULT	MASTER II Kasten (FD_) (98-06)	BAV1004	Classic PKW	MERCEDES BENZ (W126) 260 SE-560 SEC (80-91)
BAR28129	RENAULT	MASTER II Pritsche/Fahrgestell (ED/HD/UD_) (98-06)	BAV1004	Classic PKW	MERCEDES BENZ (W201) 190-190 E 2,6 (82-93)
BAR28129	RENAULT	MASTER III Bus (JD_) (06-)	BAV1004	Classic PKW	MERCEDES BENZ G-Klasse (W460) (79-93)
BAR28129	RENAULT	MASTER III Kasten (FD_) (06-)	BAV1004	Classic PKW	MERCEDES BENZ Transporter (BM 601) 207 D-210 D
BAR28129	RENAULT	MASTER III Pritsche/Fahrgestell (ED/HD/UD_) (06-)	BAV1004	Classic PKW	MERCEDES BENZ Transporter (BM 602) 307 D-310 D
BAR28132	NISSAN	PRIMASTAR (X83) Bus (01-)	BAV1004	Classic PKW	MERCEDES BENZ Transporter (BM 611) 407 D-410 D
BAR28132	NISSAN	PRIMASTAR (X83) Van (02-)	BAV1004	Classic PKW	MERCEDES BENZ Transporter (BM 667) 507 D-510
BAR28132	OPEL	VIVARO (01-)	BAV1004	MERCEDES BENZ	A-Klasse (W168) (97-04)
BAR28132	RENAULT	TRAFIC II (JL/FL/EL) (01-)	BAV1004	MERCEDES BENZ	C-Klasse (W202) Limousine (93-00)
BAR28136	CITROEN	C8 (02-)	BAV1004	MERCEDES BENZ	C-Klasse (S202) Kombi (96-01)
BAR28136	CITROEN	JUMPY Kombi (95-06)	BAV1004	MERCEDES BENZ	CL-Klasse (C140) Coupe (96-99)
BAR28136	CITROEN	JUMPY Kasten (95-06)	BAV1004	MERCEDES BENZ	CLK-Klasse (C208) Coupe (97-02)
BAR28136	CITROEN	JUMPY Pritsche/Fahrgestell (99-06)	BAV1004	MERCEDES BENZ	CLK-Klasse (A208) Cabrio (98-03)
BAR28136	FIAT	SCUDO (95-06)	BAV1004	MERCEDES BENZ	E-Klasse (W124) (93-97)
BAR28136	FIAT	ULYSSE (02-11)	BAV1004	MERCEDES BENZ	E-Klasse (W210) Limousine (95-02)
BAR28136	LANCIA	PHEDRA (02-10)	BAV1004	MERCEDES BENZ	E-Klasse (S210) Kombi (96-03)
BAR28136	PEUGEOT	807 (02-)	BAV1004	MERCEDES BENZ	S-Klasse (W140) (91-93)
BAR28136	PEUGEOT	EXPERT Kombi (95-06)	BAV1004	MERCEDES BENZ	S-Klasse (W140) (93-98)
BAR28136	PEUGEOT	EXPERT Kasten (95-06)	BAV1004	MERCEDES BENZ	SL-Klasse (R129) (93-01)
BAR28136	PEUGEOT	EXPERT Pritsche/Fahrgestell (95-06)	BAV1004	MERCEDES BENZ	SLK-Klasse (R170) (96-04)
BAR28140	NISSAN	ALMERA TINO (V10M) (00-05)	BAV1005	BMW	3er Reihe/E36 (91-00)
BAR28140	NISSAN	MAXIMA (CA33) (00-06)	BAV1006	BMW	3er Reihe/E36 (91-00)
BAR28140	NISSAN	PRIMERA (P12E) Limousine (02-08)	BAV1006	BMW	Z3 (95-02)
BAR28140	NISSAN	PRIMERA (W12) Kombi (02-08)	BAV1007	Classic PKW	BMW 3er Reihe/E30 (82-93)
BAR28140	NISSAN	X-TRAIL (T30) (01-07)	BAV1007	Classic PKW	BMW 5er Reihe/E28 (81-87)
BAR28142	MERCEDES BENZ	CLS-Klasse (C219) Coupe (04-10)	BAV1007	Classic PKW	BMW 6er Reihe/E24 (76-89)
BAR28142	MERCEDES BENZ	E-Klasse (W211) Limousine (02-09)	BAV1007	Classic PKW	BMW Z1 (88-91)
BAR28142	MERCEDES BENZ	E-Klasse (S211) Kombi (03-09)	BAV1008	Classic PKW	MERCEDES BENZ G-Klasse (W461) (90-)
BAR30101	BMW	5er Reihe/E39 (96-03)	BAV1008	MERCEDES BENZ	G-Klasse (W463) (90-)
BAR30101	BMW	7er Reihe/E32 (86-94)	BAV1008	MERCEDES BENZ	G-Klasse (W463) Cabrio (90-)
BAR30101	BMW	7er Reihe/E38 (93-01)	BAV1008	MERCEDES BENZ	V-Klasse (BM638) (96-03)
BAR30101	BMW	8er Reihe/E31 (90-99)	BAV1008	MERCEDES BENZ	VITO (BM638) (96-03)
BAR30109	BMW	X3 (03-10)	BAV1008	MERCEDES BENZ	Transporter (BM 901/902) SPRINTER (95-06)
BAR30109	BMW	X5 (00-07)	BAV1008	MERCEDES BENZ	Transporter (BM 903/904) SPRINTER (95-06)
BAR30173	BMW	5er Reihe/E60 Limousine (03-10)	BAV1008	MERCEDES BENZ	Transporter (BM 905) SPRINTER (01-06)
BAR30173	BMW	5er Reihe/E61 Touring (04-10)	BAV1008	VOLKSWAGEN	LT/- 4x4 (96-06)
BAR30173	BMW	6er Reihe/E63 Coupe (04-11)	BAV1009	BMW	5er Reihe/E39 (96-03)
BAR30173	BMW	6er Reihe/E64 Cabrio (04-11)	BAV1010	BMW	5er Reihe/E39 (96-03)
BAR32115	MERCEDES BENZ	CL-Klasse (C215) Coupe (99-06)	BAV1010	BMW	Z8 (00-03)
BAR32115	MERCEDES BENZ	S-Klasse (W220) (98-06)	BAV1011	BMW	3er Reihe/E36 (91-00)
BAV1001	Classic PKW	MERCEDES BENZ (W124) E-Klasse (85-93)	BAV1011	BMW	Z3 (95-02)
BAV1001	Classic PKW	MERCEDES BENZ (W201) 190-190 E 2,6 (82-93)	BAV1012	BMW	3er Reihe/E46 (98-06)
BAV1001	MERCEDES BENZ	E-Klasse (W124) (93-97)	BAV1012	BMW	Z4 Roadster/E85 (03-08)

# Neue Artikel

Nouvelles références / Codici nuovi / Novo artigos /  
Nowe artykuły / Nové výrobky

 			 		
<b>BAV1013</b>	BMW	3er Reihe/E46 (98-06)	<b>BAV1033</b>	MERCEDES BENZ	Transporter (BM 905) SPRINTER (01-06)
<b>BAV1014</b>	OPEL	ASTRA G / Vauxhall Astra MKIV (98-04)	<b>BAV1033</b>	MERCEDES BENZ	Transporter VARIO (96-)
<b>BAV1014</b>	OPEL	ZAFIRA I / Vauxhall Zafira I (99-05)	<b>BAV1034</b>	MERCEDES BENZ	Transporter (BM 905) SPRINTER (01-06)
<b>BAV1014</b>	SAAB	9-3 Limousine (YS3D) (98-02)	<b>BAV1035</b>	Classic PKW	BMW 3er Reihe/E21 (75-83)
<b>BAV1014</b>	SAAB	9-3 Coupe (YS3D) (98-02)	<b>BAV1035</b>	Classic PKW	BMW 5er Reihe/E12 (72-81)
<b>BAV1014</b>	SAAB	9-3 Cabriolet (YS3D) (98-03)	<b>BAV1035</b>	Classic PKW	BMW 5er Reihe/E28 (81-87)
<b>BAV1014</b>	SAAB	9-5 Limousine (YS3E) (97-10)	<b>BAV1035</b>	Classic PKW	BMW 6er Reihe/E24 (76-89)
<b>BAV1014</b>	SAAB	9-5 Kombi (YS3E) (98-10)	<b>BAV1035</b>	Classic PKW	BMW 7er Reihe/E23 (77-86)
<b>BAV1014</b>	SAAB	900 (94-98)	<b>BAV1036</b>	BMW	7er Reihe/E38 (93-01)
<b>BAV1015</b>	BMW	5er Reihe/E39 (96-03)	<b>BAV1037</b>	BMW	7er Reihe/E65/E66 (02-08)
<b>BAV1016</b>	OPEL	VECTRA B / Vauxhall Vectra (96-02)	<b>BAV1038</b>	MINI	R50/R53 (00-06)
<b>BAV1017</b>	OPEL	OMEGA B / Vauxhall Omega (94-03)	<b>BAV1038</b>	MINI	R52 Cabrio (04-08)
<b>BAV1018</b>	BMW	X5 (00-07)	<b>BAV1039</b>	MINI	R50/R53 (00-06)
<b>BAV1019</b>	BMW	X5 (00-07)	<b>BAV1039</b>	MINI	R52 Cabrio (04-08)
<b>BAV1020</b>	OPEL	SIGNUM / Vauxhall Signum (03-08)	<b>BAV1040</b>	BMW	5er Reihe/E60 Limousine (03-10)
<b>BAV1020</b>	OPEL	VECTRA C (F68,F69)/Vau. Vectra MK II (02-08)	<b>BAV1040</b>	BMW	6er Reihe/E63 Coupe (04-11)
<b>BAV1020</b>	OPEL	VECTRA C Caravan (F35) / Vau. MK II (03-08)	<b>BAV1040</b>	BMW	6er Reihe/E64 Cabrio (04-11)
<b>BAV1021</b>	BMW	3er Reihe/E46 (98-06)	<b>BAV1041</b>	BMW	5er Reihe/E61 Touring (04-10)
<b>BAV1022</b>	BMW	7er Reihe/E65/E66 (02-08)	<b>BAV1042</b>	BMW	1er Reihe/E81/E87 Limousine (04-11)
<b>BAV1023</b>	MERCEDES BENZ	C-Klasse (S203) Kombi (01-07)	<b>BAV1042</b>	BMW	1er Reihe/E82 Coupe (07-)
<b>BAV1023</b>	MERCEDES BENZ	CLK-Klasse (A209) Cabrio (03-09)	<b>BAV1042</b>	BMW	1er Reihe/E88 Cabrio (08-)
<b>BAV1023</b>	MERCEDES BENZ	CLS-Klasse (C219) Coupe (04-10)	<b>BAV1042</b>	BMW	3er Reihe/E90 Limousine (05-)
<b>BAV1023</b>	MERCEDES BENZ	E-Klasse (W211) Limousine (02-09)	<b>BAV1042</b>	BMW	3er Reihe/E91 Touring (05-)
<b>BAV1023</b>	MERCEDES BENZ	E-Klasse (S211) Kombi (03-09)	<b>BAV1042</b>	BMW	3er Reihe/E92 Coupe (06-)
<b>BAV1023</b>	MERCEDES BENZ	S-Klasse (W220) (98-06)	<b>BAV1042</b>	BMW	3er Reihe/E93 Cabrio (07-)
<b>BAV1023</b>	MERCEDES BENZ	SL-Klasse (R230) (01-11)	<b>BAV1043</b>	BMW	1er Reihe/E81/E87 Limousine (04-11)
<b>BAV1023</b>	MERCEDES BENZ	SLK-Klasse (R171) (04-11)	<b>BAV1043</b>	BMW	1er Reihe/E82 Coupe (07-)
<b>BAV1024</b>	MERCEDES BENZ	M-Klasse (W163) (98-05)	<b>BAV1043</b>	BMW	1er Reihe/E88 Cabrio (08-)
<b>BAV1025</b>	BMW	5er Reihe/E60 Limousine (03-10)	<b>BAV1043</b>	BMW	3er Reihe/E90 Limousine (05-)
<b>BAV1025</b>	BMW	5er Reihe/E61 Touring (04-10)	<b>BAV1043</b>	BMW	3er Reihe/E91 Touring (05-)
<b>BAV1025</b>	BMW	6er Reihe/E63 Coupe (04-11)	<b>BAV1043</b>	BMW	3er Reihe/E92 Coupe (06-)
<b>BAV1025</b>	BMW	6er Reihe/E64 Cabrio (04-11)	<b>BAV1043</b>	BMW	3er Reihe/E93 Cabrio (07-)
<b>BAV1026</b>	MERCEDES BENZ	V-Klasse (BM638) (96-03)	<b>BAV1044</b>	MINI	R55 Clubman (07-)
<b>BAV1026</b>	MERCEDES BENZ	VITO (BM638) (96-03)	<b>BAV1044</b>	MINI	R56 (06-)
<b>BAV1026</b>	MERCEDES BENZ	Transporter (BM 901/902) SPRINTER (95-06)	<b>BAV1044</b>	MINI	R57 Cabrio (09-)
<b>BAV1026</b>	MERCEDES BENZ	Transporter (BM 903/904) SPRINTER (95-06)	<b>BAV1045</b>	MINI	R55 Clubman (07-)
<b>BAV1026</b>	MERCEDES BENZ	Transporter (BM 905) SPRINTER (01-06)	<b>BAV1045</b>	MINI	R56 (06-)
<b>BAV1026</b>	VOLKSWAGEN	LT/- 4x4 (96-06)	<b>BAV1045</b>	MINI	R57 Cabrio (09-)
<b>BAV1027</b>	OPEL	ASTRA F / Vauxhall Astra MKIII (91-01)	<b>BAV1046</b>	MAYBACH	(W240) (02-)
<b>BAV1027</b>	OPEL	CALIBRA / Vauxhall Calibra (89-97)	<b>BAV1046</b>	MERCEDES BENZ	A-Klasse (W169 ) (04-11)
<b>BAV1027</b>	OPEL	VECTRA A / Vauxhall Cavalier (89-95)	<b>BAV1046</b>	MERCEDES BENZ	B-Klasse (W245) (05-11)
<b>BAV1028</b>	OPEL	ASTRA F / Vauxhall Astra MKIII (91-01)	<b>BAV1046</b>	MERCEDES BENZ	C-Klasse (W203) Limousine (00-07)
<b>BAV1028</b>	OPEL	CALIBRA / Vauxhall Calibra (89-97)	<b>BAV1046</b>	MERCEDES BENZ	C-Klasse (S203) Kombi (01-07)
<b>BAV1028</b>	OPEL	VECTRA A / Vauxhall Cavalier (89-95)	<b>BAV1046</b>	MERCEDES BENZ	C-Klasse (CL203) Sportcoupe (01-08)
<b>BAV1029</b>	Classic PKW	OPEL OMEGA A / Vauxhall Carlton (87-93)	<b>BAV1046</b>	MERCEDES BENZ	C-Klasse (CLC203) Coupe (08-10)
<b>BAV1030</b>	OPEL	VECTRA B / Vauxhall Vectra (96-02)	<b>BAV1046</b>	MERCEDES BENZ	C-Klasse (W204) Limousine (07-)
<b>BAV1031</b>	BMW	3er Reihe/E36 (91-00)	<b>BAV1046</b>	MERCEDES BENZ	C-Klasse (S204) Kombi (07-)
<b>BAV1031</b>	BMW	Z3 (95-02)	<b>BAV1046</b>	MERCEDES BENZ	C-Klasse (C204) Coupe (11-)
<b>BAV1032</b>	Classic PKW	MERCEDES BENZ G-Klasse (W460) (79-93)	<b>BAV1046</b>	MERCEDES BENZ	CL-Klasse (C215) Coupe (99-06)
<b>BAV1032</b>	Classic PKW	MERCEDES BENZ G-Klasse (W461) (90-)	<b>BAV1046</b>	MERCEDES BENZ	CL-Klasse (C216) Coupe (06-)
<b>BAV1032</b>	MERCEDES BENZ	G-Klasse (W463) (90-)	<b>BAV1046</b>	MERCEDES BENZ	CLK-Klasse (C209) Coupe (02-09)
<b>BAV1032</b>	MERCEDES BENZ	G-Klasse (W463) Cabrio (90-)	<b>BAV1046</b>	MERCEDES BENZ	CLK-Klasse (A209) Cabrio (03-09)
<b>BAV1033</b>	Classic PKW	MERCEDES BENZ Transporter (BM 668) 609 D	<b>BAV1046</b>	MERCEDES BENZ	CLS-Klasse (C219) Coupe (04-10)
<b>BAV1033</b>	Classic PKW	MERCEDES BENZ Transporter (BM 669) 709 D/711 D	<b>BAV1046</b>	MERCEDES BENZ	CLS-Klasse (C218) Coupe (10-)
<b>BAV1033</b>	Classic PKW	MERCEDES BENZ Transporter (BM 670) 809 D-814 D	<b>BAV1046</b>	MERCEDES BENZ	CLS-Klasse (X218) Shooting Brake (12-)

# Neue Artikel





Nouvelles références / Codici nuovi / Novo artigos /  
Nowe artykuły / Nové výrobky

 			 		
BAW1046	MERCEDES BENZ	E-Klasse (W211) Limousine (02-09)	BAW1906	FIAT	SCUDO (95-06)
BAW1046	MERCEDES BENZ	E-Klasse (S211) Kombi (03-09)	BAW1906	FIAT	ULYSSE (94-02)
BAW1046	MERCEDES BENZ	E-Klasse (W212) Limousine (09-)	BAW1906	LANCIA	ZETA (94-02)
BAW1046	MERCEDES BENZ	E-Klasse (S212) Kombi (09-)	BAW1906	PEUGEOT	806 (94-02)
BAW1046	MERCEDES BENZ	E-Klasse (C207) Coupe (09-)	BAW1906	PEUGEOT	EXPERT Kombi (95-06)
BAW1046	MERCEDES BENZ	E-Klasse (A207) Cabrio (10-)	BAW1906	PEUGEOT	EXPERT Kasten (95-06)
BAW1046	MERCEDES BENZ	GLK-Klasse (X204) (08-)	BAW1906	PEUGEOT	EXPERT Pritsche/Fahrgestell (95-06)
BAW1046	MERCEDES BENZ	M-Klasse (W166) (11-)	BAW1907	DACIA	LOGAN Express (FS_) (09-)
BAW1046	MERCEDES BENZ	S-Klasse (W220) (98-06)	BAW1907	DACIA	LOGAN Limousine (LS_) (04-)
BAW1046	MERCEDES BENZ	S-Klasse (W221) (06-)	BAW1907	RENAULT	CLIO II Limousine (BB_/CB_) (98-)
BAW1046	MERCEDES BENZ	SL-Klasse (R230) (01-11)	BAW1907	RENAULT	CLIO II Kasten (SB_) (98-)
BAW1046	MERCEDES BENZ	SL-Klasse (R231) (12-)	BAW1907	RENAULT	LOGAN (LS_) (04-)
BAW1046	MERCEDES BENZ	SLK-Klasse (R171) (04-11)	BAW1907	RENAULT	LOGAN Kombi (KS_) (04-)
BAW1046	MERCEDES BENZ	SLK-Klasse (R172) (11-)	BAW1907	RENAULT	SANDERO (BS0_) (09-)
BAW1046	MERCEDES BENZ	SLR-Klasse (C199) Coupe (04-09)	BAW1907	RENAULT	THALIA (LB_) (98-)
BAW1046	MERCEDES BENZ	VANEO (BM414) (02-05)	BAW1908	RENAULT	MEGANE I Limousine 3/5-türig (BA/SA_) (96-02)
BAW1047	MERCEDES BENZ	M-Klasse (W163) (98-05)	BAW1908	RENAULT	MEGANE I Classic (LA_) (96-02)
BAW1048	MERCEDES BENZ	VIANO (BM639) (03-)	BAW1908	RENAULT	MEGANE I Coach (DA_) (95-03)
BAW1048	MERCEDES BENZ	VITO (BM639) (03-)	BAW1908	RENAULT	MEGANE I Cabrio (EA_) (96-03)
BAW1048	MERCEDES BENZ	Transporter (BM 906) SPRINTER (06-)	BAW1909	CITROEN	AX (86-98)
BAW1048	VOLKSWAGEN	CRAFTER (06-)	BAW1909	CITROEN	SAXO (96-04)
BAW1049	OPEL	OMEGA B / Vauxhall Omega (94-03)	BAW1909	PEUGEOT	106 (91-96)
BAW1050	PORSCHE	911 (996) (97-05)	BAW1909	PEUGEOT	106 (96-04)
BAW1050	PORSCHE	911 TARGA (996) (01-05)	BAW1910	CITROEN	AX (86-98)
BAW1050	PORSCHE	911 CABRIO (996) (98-05)	BAW1910	CITROEN	SAXO (96-04)
BAW1050	PORSCHE	911 COUPE (997) (04-)	BAW1910	PEUGEOT	106 (91-96)
BAW1050	PORSCHE	911 CABRIO (997) (05-)	BAW1910	PEUGEOT	106 (96-04)
BAW1050	PORSCHE	BOXSTER (986) (96-04)	BAW1911	HONDA	CIVIC (5-türig) (94-96)
BAW1051	PORSCHE	BOXSTER (986) (96-04)	BAW1911	HONDA	CIVIC AERODECK (98-01)
BAW1051	PORSCHE	BOXSTER (987) (05-11)	BAW1911	HYUNDAI	ACCENT II (00-05)
BAW1051	PORSCHE	CAYMAN (987C) (05-)	BAW1911	HYUNDAI	ELANTRA (00-06)
BAW1052	AUDI	Q7 (06-)	BAW1911	HYUNDAI	LANTRA (00-03)
BAW1052	PORSCHE	CAYENNE I (03-10)	BAW1911	HYUNDAI	MATRIX (01-08)
BAW1052	VOLKSWAGEN	TOUAREG I (03-10)	BAW1911	ROVER	25-Serie (RF) (99-)
BAW1053	AUDI	Q7 (06-)	BAW1911	ROVER	45-Serie (RT) (00-)
BAW1053	PORSCHE	CAYENNE I (03-10)	BAW1911	ROVER	200 II-Serie (RF) (96-00)
BAW1053	VOLKSWAGEN	TOUAREG I (03-10)	BAW1911	ROVER	400-Serie (RT) (95-00)
BAW1054	IVECO	DAILY I / GRINTA (78-99)	BAW1912	CITROEN	AX (86-98)
BAW1054	IVECO	DAILY II (99-06)	BAW1912	CITROEN	SAXO (96-04)
BAW1055	LAND ROVER	DISCOVERY III (04-09)	BAW1912	PEUGEOT	106 (91-96)
BAW1055	LAND ROVER	RANGE ROVER SPORT (LS) (05-)	BAW1912	PEUGEOT	106 (96-04)
BAW1056	LAND ROVER	DISCOVERY III (04-09)	BAW1913	CITROEN	AX (86-98)
BAW1056	LAND ROVER	RANGE ROVER SPORT (LS) (05-)	BAW1913	CITROEN	SAXO (96-04)
BAW1706	MERCEDES BENZ	A-Klasse (W168) (97-04)	BAW1913	PEUGEOT	106 (91-96)
BAW1707	DACIA	LOGAN Express (FS_) (09-)	BAW1913	PEUGEOT	106 (96-04)
BAW1707	DACIA	LOGAN Limousine (LS_) (04-)	BAW1914	FORD	FIESTA IV (96-02)
BAW1707	DACIA	SANDERO (08-)	BAW1914	FORD	FIESTA V (02-08)
BAW1707	RENAULT	CLIO II Limousine (BB_/CB_) (98-)	BAW1914	FORD	FUSION (02-)
BAW1707	RENAULT	CLIO II Kasten (SB_) (98-)	BAW1914	FORD	KA I (96-08)
BAW1707	RENAULT	SANDERO (BS0_) (09-)	BAW1914	FORD	PUMA (97-01)
BAW1707	RENAULT	THALIA (LB_) (98-)	BAW1914	FORD	STREET KA (03-06)
BAW1906	CITROEN	EVASION (94-02)	BAW1914	MAZDA	121 (96-03)
BAW1906	CITROEN	JUMPY Kombi (95-06)	BAW1914	MAZDA	2 (03-07)
BAW1906	CITROEN	JUMPY Kasten (95-06)	BAW1914	MAZDA	DEMIO (03-)
BAW1906	CITROEN	JUMPY Pritsche/Fahrgestell (99-06)	BAW2007	Classic PKW	FORD CONSUL / GRANADA (72-85)

# Neue Artikel

Nouvelles références / Codici nuovi / Novo artigos /

Nowe artykuły / Nové výrobky

 			 		
<b>BAW2007</b>	Classic PKW	FORD SIERRA (82-86)	<b>BAW2501</b>	RENAULT	MASTER I Pritsche/Fahrgestell (80-98)
<b>BAW2007</b>	Classic PKW	FORD SIERRA (87-93)	<b>BAW2600</b>	CITROEN	JUMPER Bus (94-02)
<b>BAW2007</b>	Classic PKW	FORD TAUNUS / CORTINA (GB) (70-82)	<b>BAW2600</b>	CITROEN	JUMPER Kasten (94-02)
<b>BAW2007</b>	FORD	ESCORT / ORION (91-94)	<b>BAW2600</b>	CITROEN	JUMPER Pritsche/Fahrgestell (94-02)
<b>BAW2007</b>	FORD	ESCORT VII (95-00)	<b>BAW2600</b>	CITROEN	JUMPER (02-06)
<b>BAW2007</b>	FORD	FOCUS I (98-04)	<b>BAW2600</b>	FIAT	DUCATO (94-02)
<b>BAW2007</b>	LAND ROVER	FREELANDER (LN) (98-06)	<b>BAW2600</b>	FIAT	DUCATO (02-06)
<b>BAW2008</b>	ALFA ROMEO	145 (94-01)	<b>BAW2600</b>	PEUGEOT	BOXER Bus (94-02)
<b>BAW2008</b>	ALFA ROMEO	146 (94-01)	<b>BAW2600</b>	PEUGEOT	BOXER Kasten (94-02)
<b>BAW2008</b>	FIAT	MAREA (96-02)	<b>BAW2600</b>	PEUGEOT	BOXER Pritsche/Fahrgestell (94-02)
<b>BAW2008</b>	FIAT	MULTIPLA (98-08)	<b>BAW2600</b>	PEUGEOT	BOXER (02-06)
<b>BAW2008</b>	FIAT	PALIO / PALIO WEEKEND EUROPA (97-06)	<b>BAW2800</b>	CITROEN	JUMPER Bus (94-02)
<b>BAW2008</b>	FIAT	TEMPRA (93-96)	<b>BAW2800</b>	CITROEN	JUMPER Kasten (94-02)
<b>BAW2008</b>	FIAT	TIPO (93-95)	<b>BAW2800</b>	CITROEN	JUMPER Pritsche/Fahrgestell (94-02)
<b>BAW2009</b>	FIAT	500 (07-)	<b>BAW2800</b>	FIAT	DUCATO (94-02)
<b>BAW2009</b>	FIAT	500C Cabrio (09-)	<b>BAW2800</b>	PEUGEOT	BOXER Bus (94-02)
<b>BAW2009</b>	FIAT	PANDA (03-)	<b>BAW2800</b>	PEUGEOT	BOXER Kasten (94-02)
<b>BAW2009</b>	FIAT	PUNTO (93-00)	<b>BAW2800</b>	PEUGEOT	BOXER Pritsche/Fahrgestell (94-02)
<b>BAW2009</b>	FORD	KA II (09-)			
<b>BAW2009</b>	LANCIA	Y (96-03)			
<b>BAW2010</b>	FORD	TOURNEO (94-00)			
<b>BAW2010</b>	FORD	TRANSIT (92-94)			
<b>BAW2010</b>	FORD	TRANSIT (95-00)			
<b>BAW2010</b>	NISSAN	TERRANO II (R20) (93-06)			
<b>BAW2202</b>	BMW	3er Reihe/E36 (91-00)			
<b>BAW2203</b>	FORD	MONDEO I (93-96)			
<b>BAW2203</b>	FORD	MONDEO II (96-00)			
<b>BAW2204</b>	SMART	CABRIO (BM450) (00-03)			
<b>BAW2204</b>	SMART	CITY COUPE (BM450) (98-04)			
<b>BAW2204</b>	SMART	CROSSBLADE (BM450) (02-04)			
<b>BAW2204</b>	SMART	FORTWO CABRIO (BM450) (04-07)			
<b>BAW2204</b>	SMART	FORTWO COUPE (BM450) (04-07)			
<b>BAW2205</b>	CITROEN	BERLINGO (MF) Kombi (96-08)			
<b>BAW2205</b>	CITROEN	BERLINGO (M_) Kasten (96-08)			
<b>BAW2205</b>	CITROEN	XSARA Picasso (N68) (00-10)			
<b>BAW2205</b>	PEUGEOT	PARTNER Kombi (96-08)			
<b>BAW2205</b>	PEUGEOT	PARTNER Kasten (96-08)			
<b>BAW2206</b>	SMART	CABRIO (BM450) (00-03)			
<b>BAW2206</b>	SMART	CITY COUPE (BM450) (98-04)			
<b>BAW2206</b>	SMART	CROSSBLADE (BM450) (02-04)			
<b>BAW2206</b>	SMART	FORTWO CABRIO (BM450) (04-07)			
<b>BAW2206</b>	SMART	FORTWO COUPE (BM450) (04-07)			
<b>BAW2207</b>	NISSAN	KUBISTAR (X76) Kombi (03-)			
<b>BAW2207</b>	RENAULT	KANGOO I (KC_) (98-07)			
<b>BAW2207</b>	RENAULT	KANGOO Express/Rapid (FC_) (98-07)			
<b>BAW2500</b>	FORD	TRANSIT (92-94)			
<b>BAW2500</b>	FORD	TRANSIT (95-00)			
<b>BAW2500</b>	FORD	TRANSIT (00-06)			
<b>BAW2500</b>	FORD	TRANSIT (06-)			
<b>BAW2501</b>	Classic PKW	ALFA ROMEO AR 6 (85-89)			
<b>BAW2501</b>	Classic PKW	CITROEN C25 (81-94)			
<b>BAW2501</b>	Classic PKW	FIAT DUCATO (81-93)			
<b>BAW2501</b>	Classic PKW	PEUGEOT J5 (81-94)			
<b>BAW2501</b>	RENAULT	MASTER I Bus (80-98)			
<b>BAW2501</b>	RENAULT	MASTER I Kasten (80-98)			





# Abbildungen Scheibenbremsbeläge

Illustrations plaquettes de frein à disque / Illustrazioni pastiglie freno /

Figuras Calços do travão de disco / Rysunki okładzin hamulców tarczowych /

Zobrazení obložení kotoučových brzd

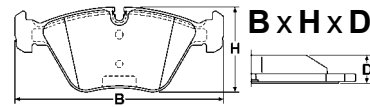

Maßstab - échelle - scala - escala - skala - měřítko 1:2

## BA2010



HONDA, MG, ROVER

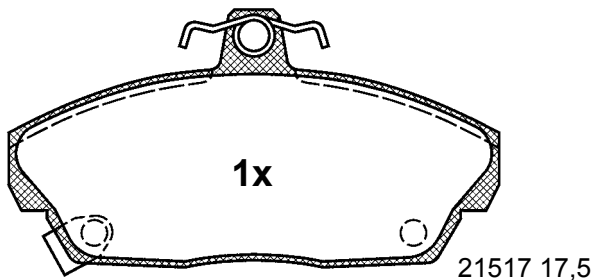
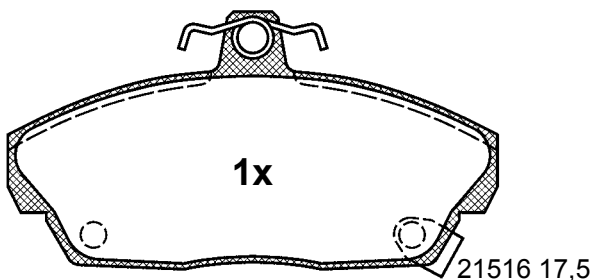
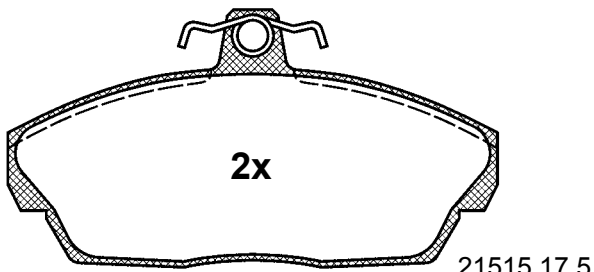

129,1 x 68,7 x 17,5

## BA2011



MG, ROVER

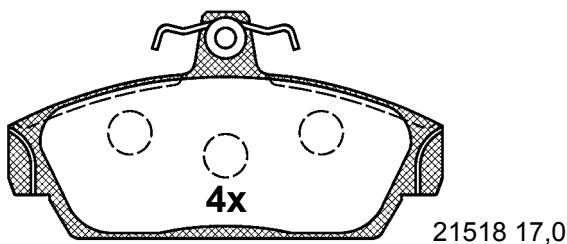

115,2 x 60,4 x 17,0

## BA2012



ROVER

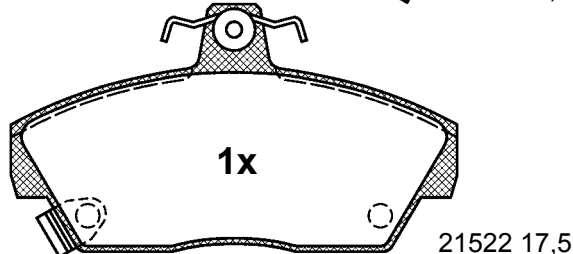
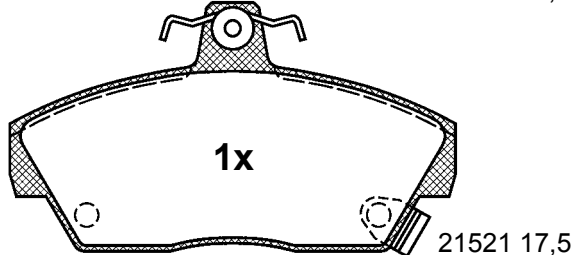
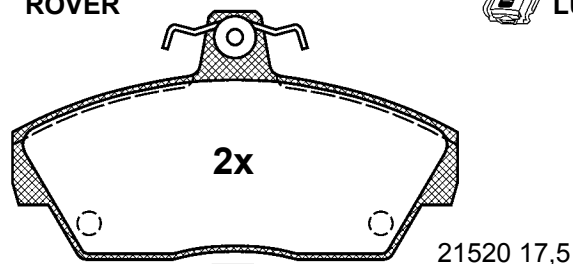

117,5 x 65,6 x 17,5

## BA2013



RENAULT

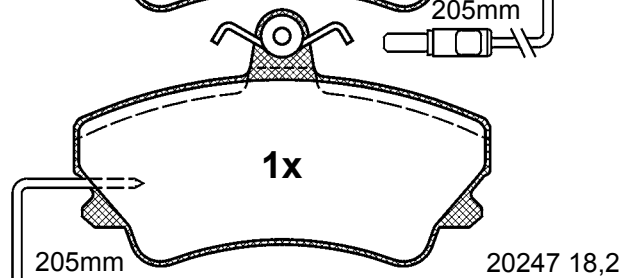
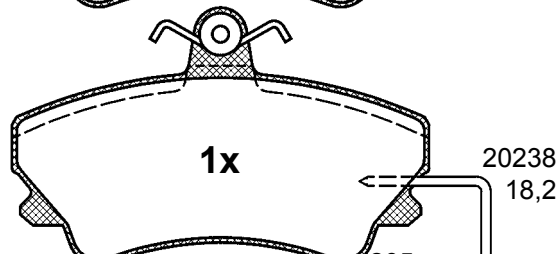
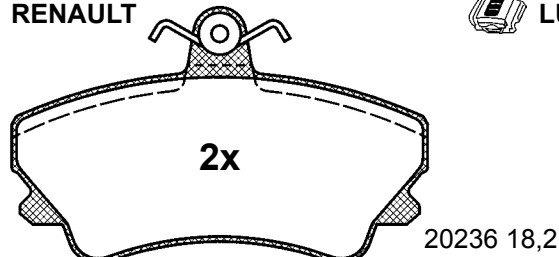

110,0 x 67,9 x 18,2

# Abbildungen Scheibenbremsbeläge

Illustrations plaquettes de frein à disque / Illustrazioni pastiglie freno /  
Figuras Calços do travão de disco / Rysunki okładzin hamulców tarczowych /  
Zobrazení obložení kotoučových brzd

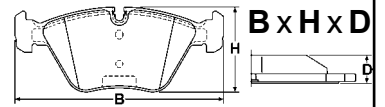

Maßstab - échelle - scala - escala - skala - měřítko 1:2

## BA2014

 VOLVO

 LUC

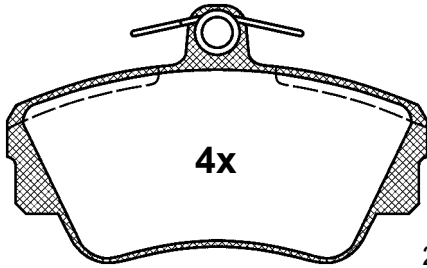

21217 17,5

109,9 x 67,5 x 17,5

## BA2017



AUDI, CITROEN, FIAT, FORD,  
LANCIA, PEUGEOT, SEAT,  
SKODA, VOLKSWAGEN

 LUC

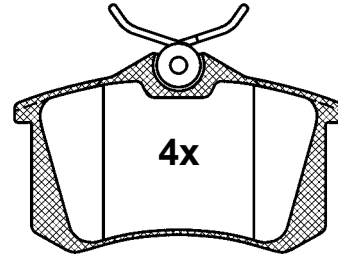

20961 17,2

87,1 x 52,9 x 17,2

## BA2015

 PEUGEOT

 LUC

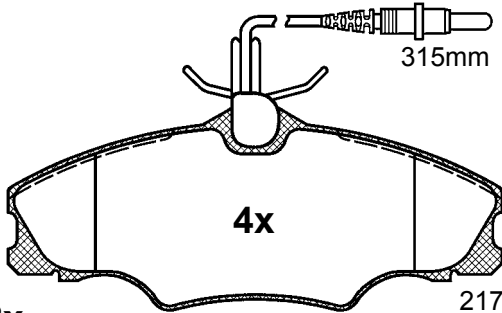

21724 18,2  
(21749)

129,8 x 53,0 x 18,2

## BA2018



SEAT, VOLKSWAGEN

 LUC

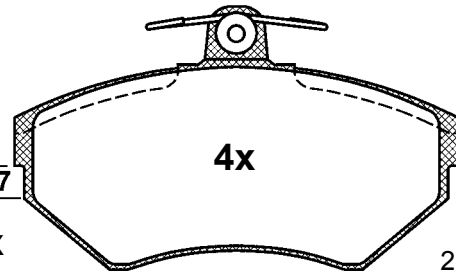

21945 16,3

118,8 x 69,6 x 16,3

## BA2019



RENAULT

 LUC

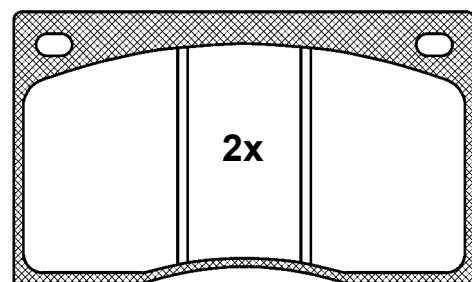

20380 15,6

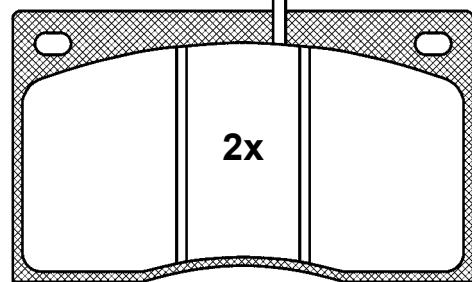
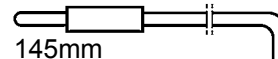

21110 15,6

119,7 x 71,0 x 15,6

## BA2016

 CITROEN, PEUGEOT

 LUC

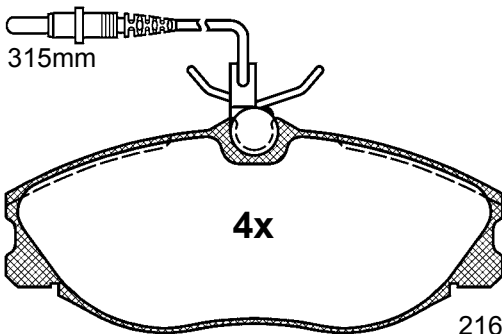

21674 19,3

129,9 x 56,5 x 19,3

# Abbildungen Scheibenbremsbeläge

Illustrations plaquettes de frein à disque / Illustrazioni pastiglie freno /  
Figuras Calços do travão de disco / Rysunki okładzin hamulców tarczowych /  
Zobrazení obložení kotoučových brzd

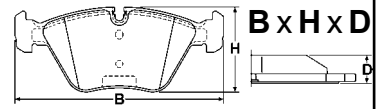

Maßstab - échelle - scala - escala - skala - měřítko 1:2

## BA2020



CITROËN

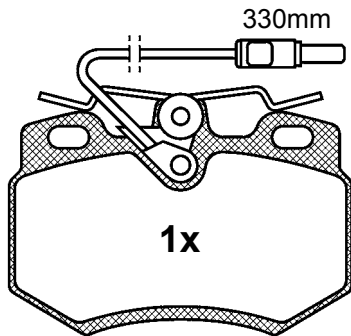

21616 17,5

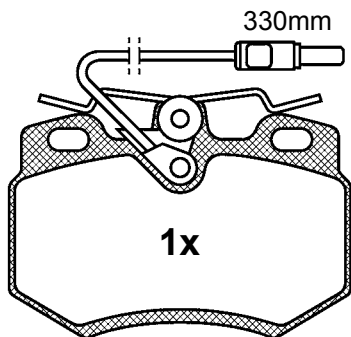

21616 17,5

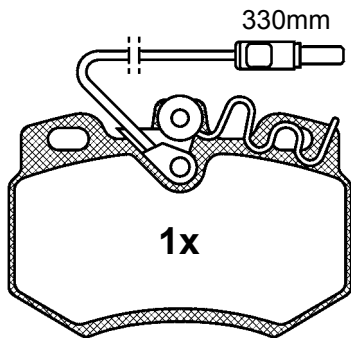

21614 17,5

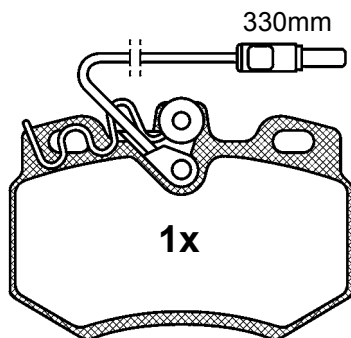

21615 17,5



89,8 x 62,9 x 17,5

## BA2021



CITROËN, PEUGEOT

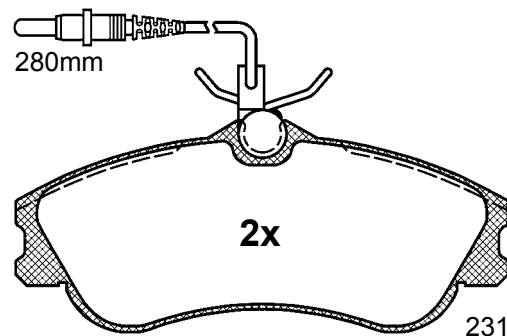

23124 19,0

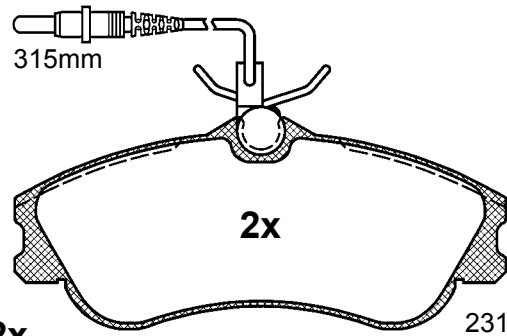

23125 19,0



129,8 x 56,0 x 19,0

## BA2022



RENAULT

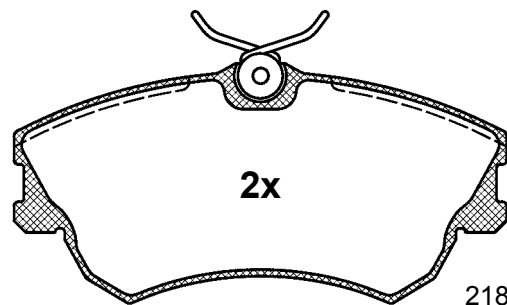

21888 18,0

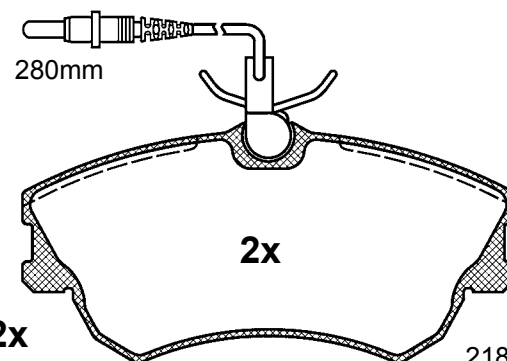

21889 18,0



129,9 x 63,1 x 18,0

# Abbildungen Scheibenbremsbeläge

Illustrations plaquettes de frein à disque / Illustrazioni pastiglie freno /  
Figuras Calços do travão de disco / Rysunki okładzin hamulców tarczowych /  
Zobrazení obložení kotoučových brzd

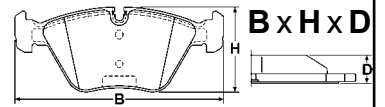

Maßstab - échelle - scala - escala - skala - měřítko 1:2

## BA2023



DACIA, RENAULT

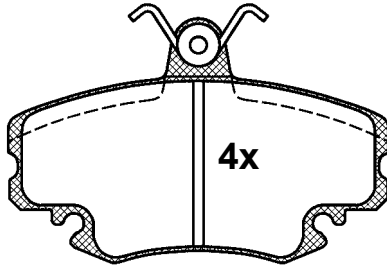

21463 18,0

100,0 x 64,9 x 18,0



M8x21

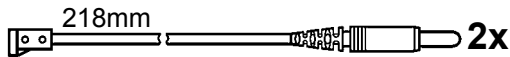

2x

## BA2025



VOLKSWAGEN

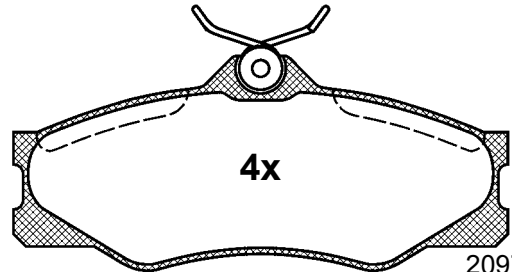

20979 19,7



M8x21

130,0 x 56,7 x 19,7

## BA2024



ALFA ROMEO, CITROEN, FIAT,  
PEUGEOT

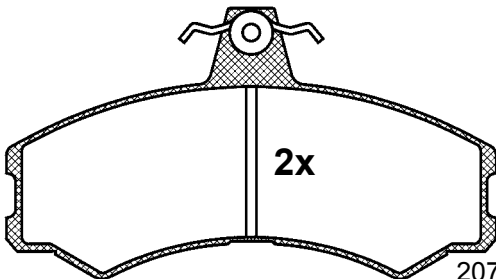

20741 19,2

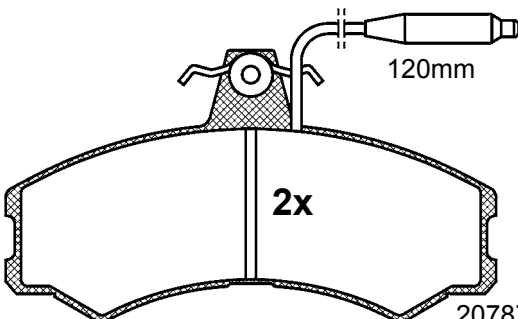

20787 19,2



M8x21

129,9 x 71,5 x 19,2

## BA2026



BMW

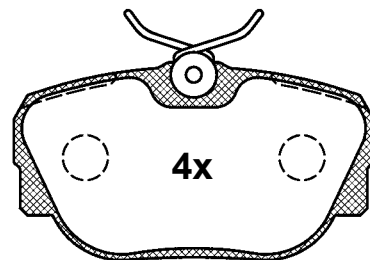

21173 17,0



M8x21

94,7 x 52,1 x 17,0

## BA2027



MERCEDES BENZ

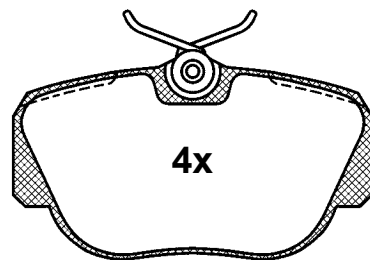

21055 16,9



M8x21

94,8 x 53,0 x 16,9

# Abbildungen Scheibenbremsbeläge

Illustrations plaquettes de frein à disque / Illustrazioni pastiglie freno /  
Figuras Calços do travão de disco / Rysunki okładzin hamulców tarczowych /  
Zobrazení obložení kotoučových brzd

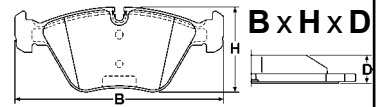

Maßstab - échelle - scala - escala - skala - měřítko 1:2

## BA2028

AUDI

LUC

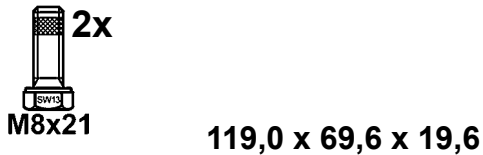
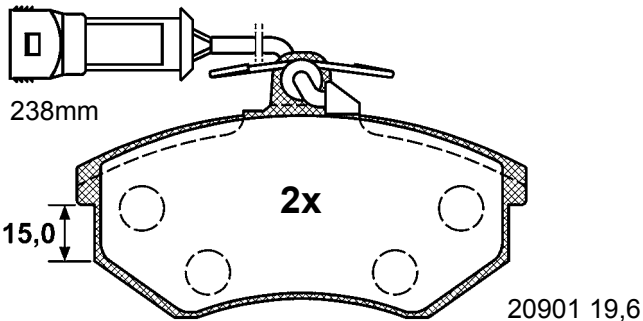
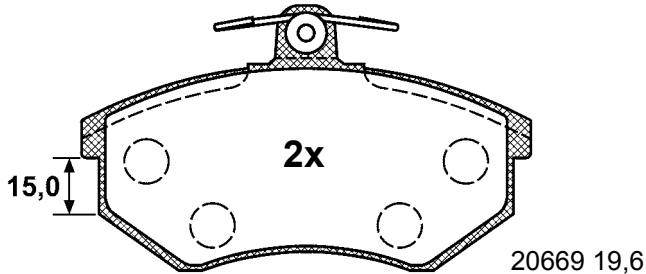

## BA2030

FORD

LUC

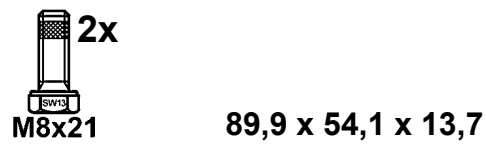
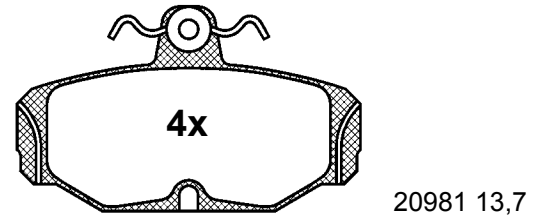

## BA2031

AUDI

LUC

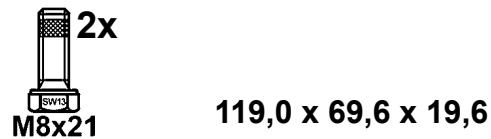
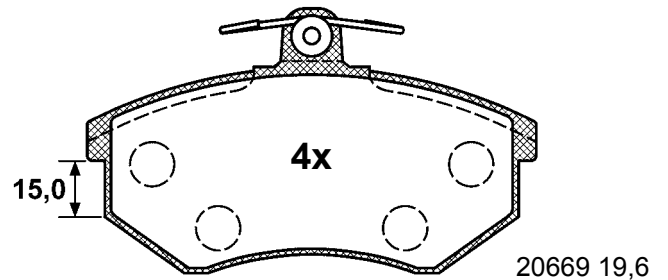

## BA2029

MERCEDES BENZ

LUC

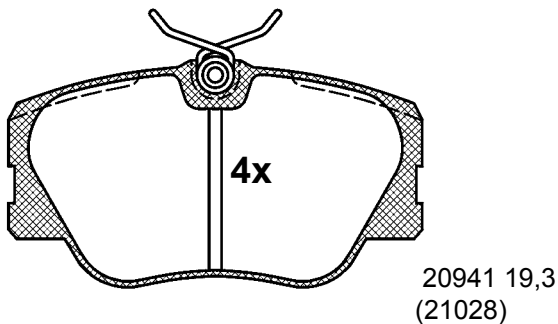

109,5 x 59,8 x 19,3

## BA2032

AUDI, PEUGEOT, SEAT, SKODA,  
VOLKSWAGEN

LUC

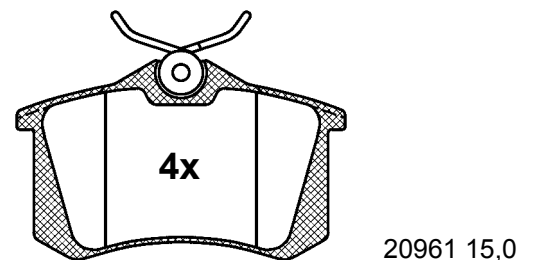

87,1 x 52,9 x 15,0

# Abbildungen Scheibenbremsbeläge

Illustrations plaquettes de frein à disque / Illustrazioni pastiglie freno /  
Figuras Calços do travão de disco / Rysunki okładzin hamulców tarczowych /  
Zobrazení obložení kotoučových brzd

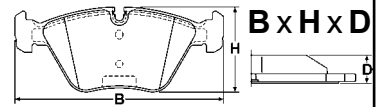

Maßstab - échelle - scala - escala - skala - měřítko 1:2

## BA2033



FIAT, LANCIA

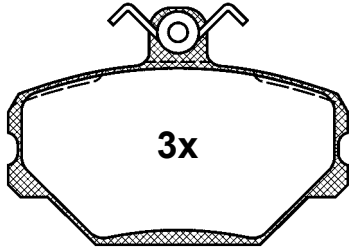

21100 17,0

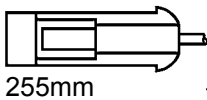

255mm

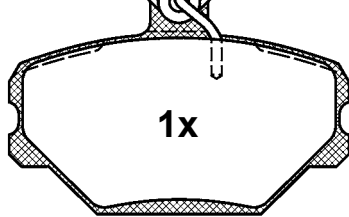

21105 17,0



90,1 x 63,3 x 17,0

## BA2036



PEUGEOT

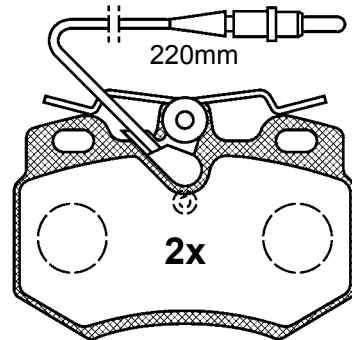

20989 17,5

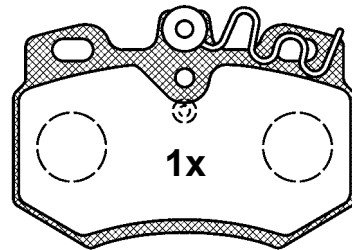

21022 17,5

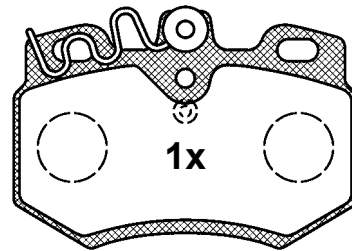

21023 17,5



89,8 x 62,9 x 17,5

## BA2034



ALFA ROMEO, FIAT, LANCIA

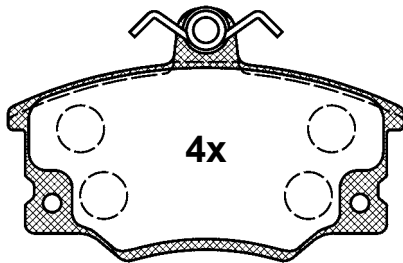

20838 17,1  
(20833)  
(20834)



104,2 x 67,0 x 17,1

## BA2037



SEAT, VOLKSWAGEN

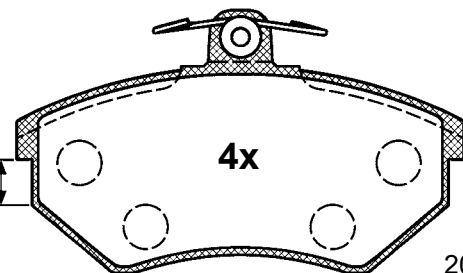

20168 16,3



ALFA ROMEO, FIAT, LANCIA

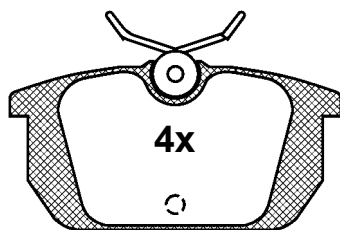

21103 14,4



87,2 x 44,7 x 14,4



118,9 x 69,6 x 16,3

# Abbildungen Scheibenbremsbeläge

Illustrations plaquettes de frein à disque / Illustrazioni pastiglie freno /  
Figuras Calços do travão de disco / Rysunki okładzin hamulców tarczowych /  
Zobrazení obložení kotoučových brzd

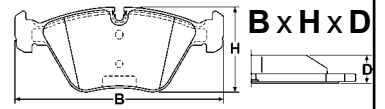

Maßstab - échelle - scala - escala - skala - měřítko 1:2

## BA2038



SEAT, VOLKSWAGEN

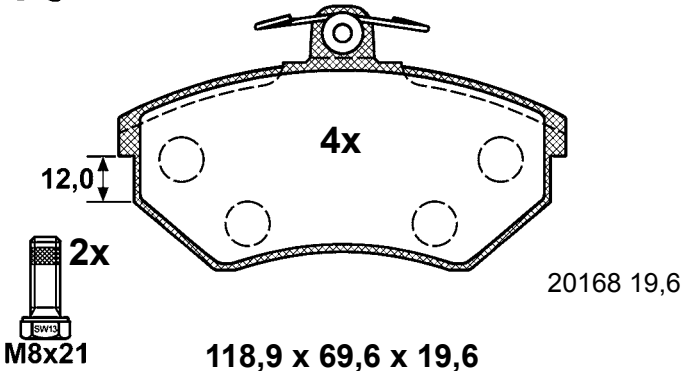

20168 19,6

## BA2043



PEUGEOT

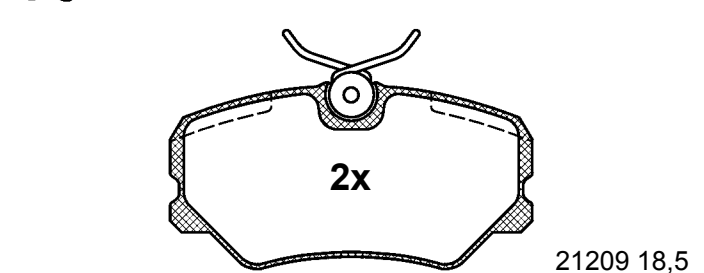

21209 18,5

## BA2039



SKODA, VOLKSWAGEN

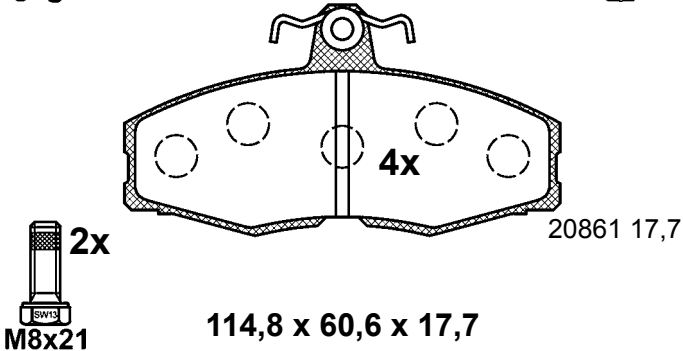

20861 17,7

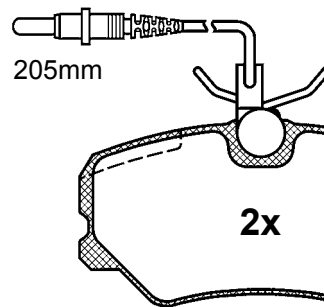

205mm



M8x21

95,0 x 48,9 x 18,5

21210 18,5

## BA2040



LADA

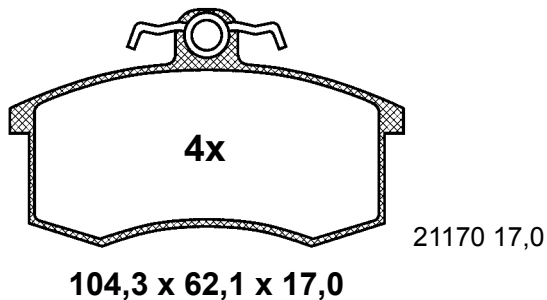

21170 17,0

104,3 x 62,1 x 17,0

## BA2044



MERCEDES BENZ

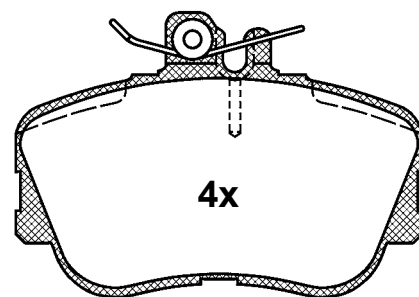

21439 20,3

## BA2041



LADA

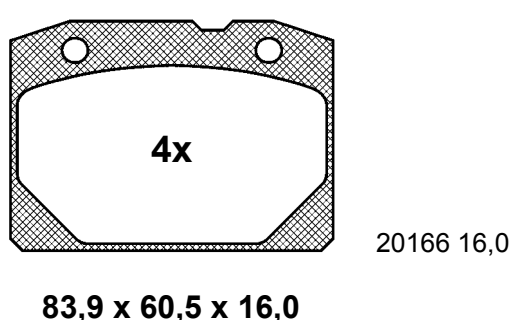

20166 16,0

83,9 x 60,5 x 16,0



M8x21

109,5 x 74,8 x 20,3



# Abbildungen Scheibenbremsbeläge

Illustrations plaquettes de frein à disque / Illustrazioni pastiglie freno /  
Figuras Calços do travão de disco / Rysunki okładzin hamulców tarczowych /  
Zobrazení obložení kotoučových brzd

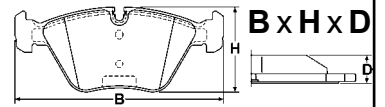

Maßstab - échelle - scala - escala - skala - měřítko 1:2

## BA2045



CITROEN, FIAT, PEUGEOT

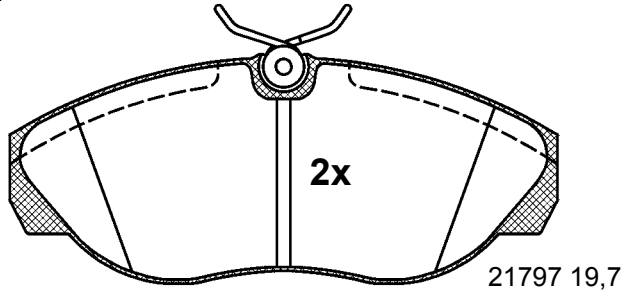

21797 19,7

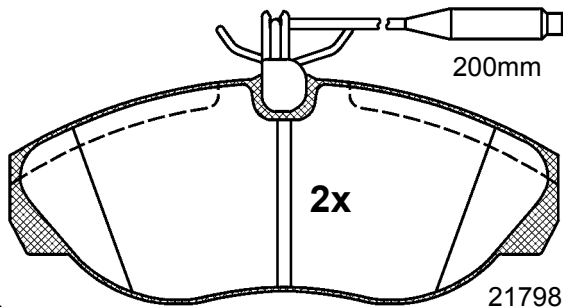

21798 19,7



145,0 x 61,0 x 19,7

## BA2047



CITROEN, FIAT, LANCIA, PEUGEOT

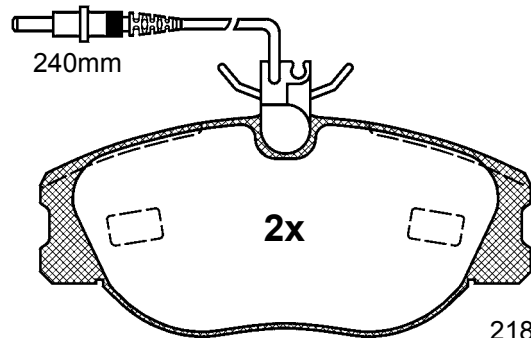

21801 19,0

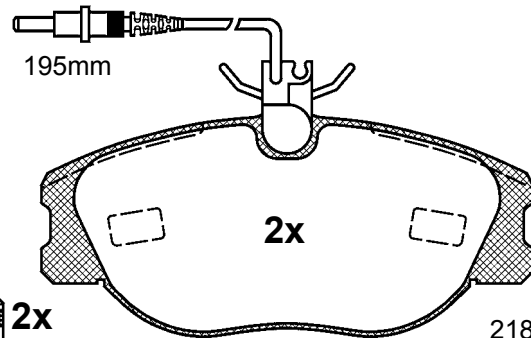

21802 19,0



130,0 x 58,8 x 19,0

## BA2046



CITROEN, FIAT, PEUGEOT

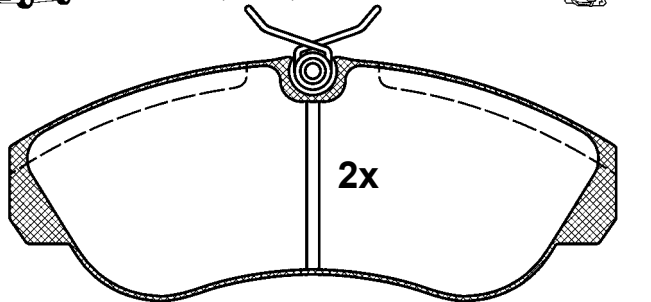

21799 19,7

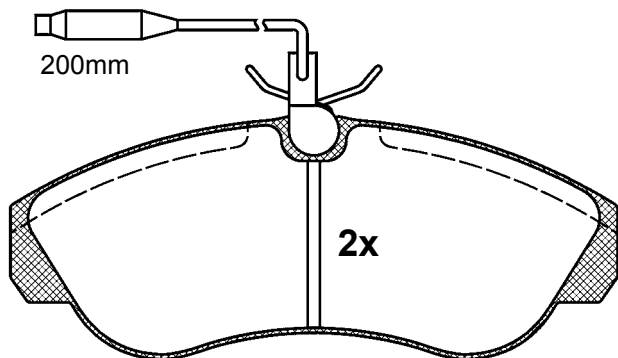

21800 19,7



159,8 x 64,3 x 19,7

## BA2048



CITROEN

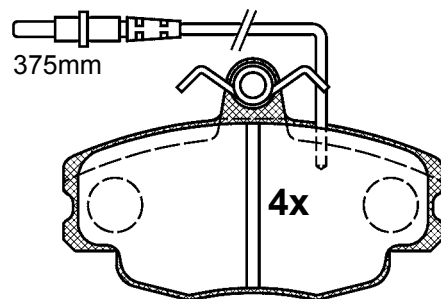

21460 18,2  
(21613)



100,0 x 63,5 x 18,2

# Abbildungen Scheibenbremsbeläge

Illustrations plaquettes de frein à disque / Illustrazioni pastiglie freno /  
Figuras Calços do travão de disco / Rysunki okładzin hamulców tarczowych /  
Zobrazení obložení kotoučových brzd

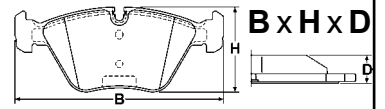

Maßstab - échelle - scala - escala - skala - měřítko 1:2

## BA2049



VOLKSWAGEN



LUC

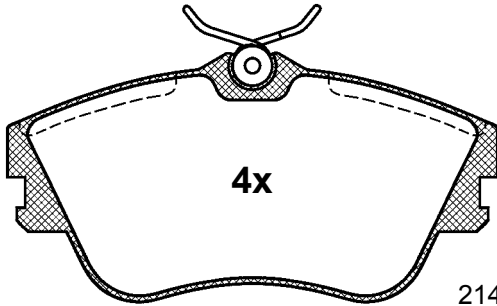

4x

21479 19,2



2x

M8x21

129,5 x 65,2 x 19,2

## BA2050



RENAULT



LUC

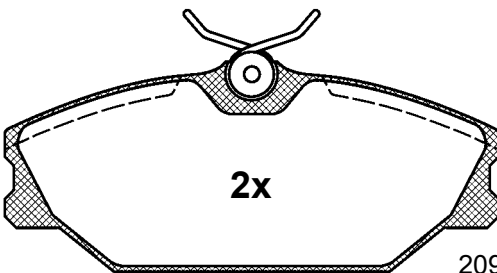

2x

20919 18,3



280mm

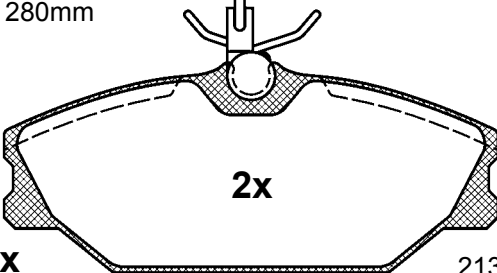

2x

21388 18,3



4x

M8x21

129,9 x 55,5 x 18,3

## BA2052



AUDI



LUC

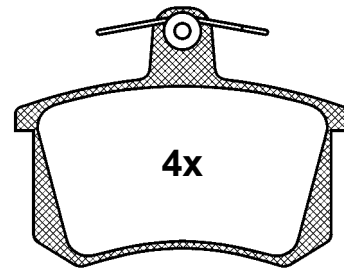

4x

21144 16,6



4x

M8x21

86,8 x 66,8 x 16,6

## BA2053



BMW, MG, ROVER, SAAB



ATE

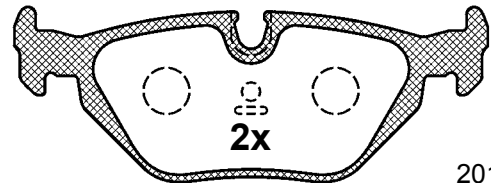

2x

20180 17,3

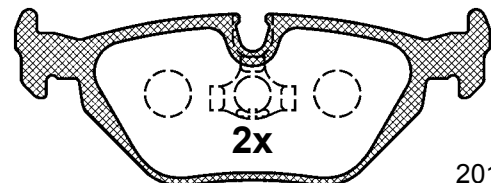

2x

20181 17,3

123,1 x 44,9 x 17,3

## BA2054



BMW



ATE

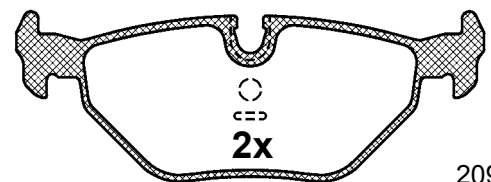

2x

20995 17,3

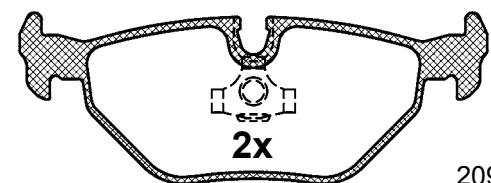

2x

20996 17,3

123,1 x 44,9 x 17,3

# Abbildungen Scheibenbremsbeläge

Illustrations plaquettes de frein à disque / Illustrazioni pastiglie freno /  
Figuras Calços do travão de disco / Rysunki okładzin hamulców tarczowych /  
Zobrazení obložení kotoučových brzd

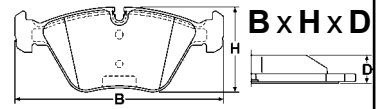

Maßstab - échelle - scala - escala - skala - měřítko 1:2

## BA2055



PEUGEOT, RENAULT

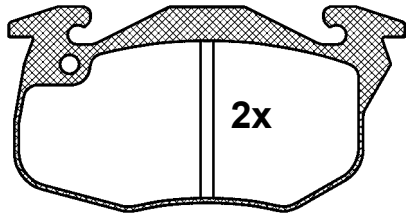

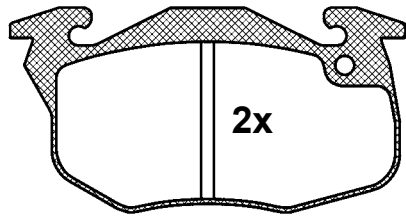

20905 18,0  
(20986)



20906 18,0  
(20987)

105,1 x 54,4 x 18,0

205mm   **2x**

## BA2060



RENAULT

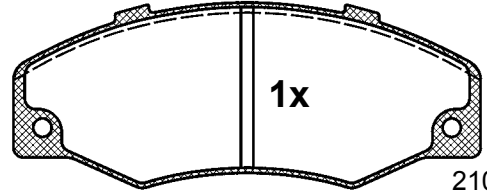

21016 17,0

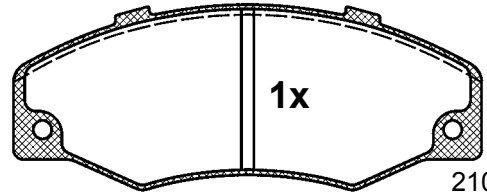

21016 17,0

## BA2056



CITROEN

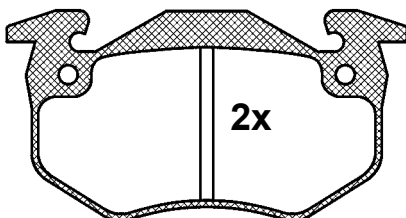



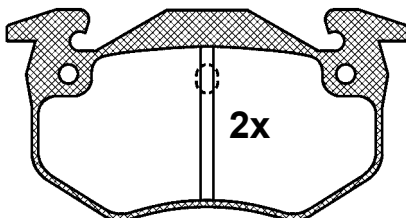

20635 18,0  
(20636)



20859 18,0  
(20860)

105,1 x 54,9 x 18,0

160mm   **2x**

245mm   **2x**

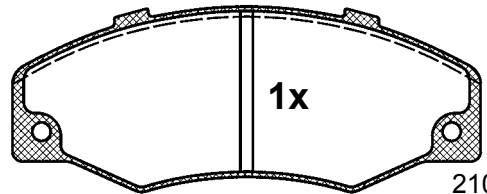

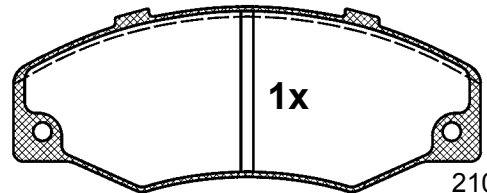

21086 17,0



21087 17,0

123,1 x 48,8 x 17,0

380mm   **2x**

# Abbildungen Scheibenbremsbeläge

Illustrations plaquettes de frein à disque / Illustrazioni pastiglie freno /

Figuras Calços do travão de disco / Rysunki okładzin hamulców tarczowych /

Zobrazení obložení kotoučových brzd

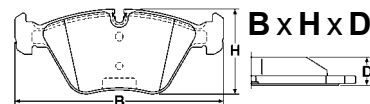

Maßstab - échelle - scala - escala - skala - měřítko 1:2

## BA2062



AUTOBIANCHI, FIAT, SEAT

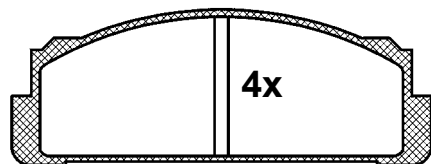

20073 17,3

108,8 x 39,0 x 17,3

## BA2066



PEUGEOT

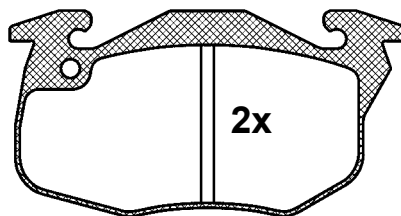



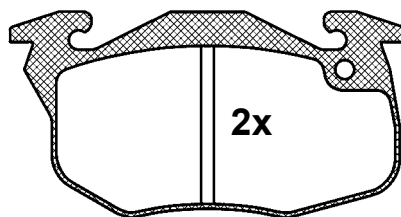

20905 18,0



20906 18,0

105,0 x 54,3 x 18,0

180mm   **2x**

305mm   **2x**

## BA2064



FIAT, SEAT

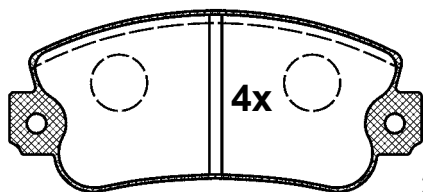

20775 18,0

108,9 x 47,4 x 18,0

## BA2068



MERCEDES BENZ

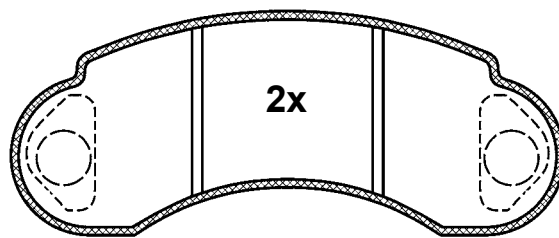

20932 14,0

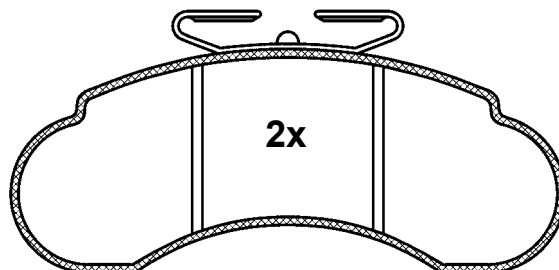

20934 14,0



145,7 x 59,2 x 14,0

## BA2065



AUTOBIANCHI, FIAT, LANCIA, SEAT



2x

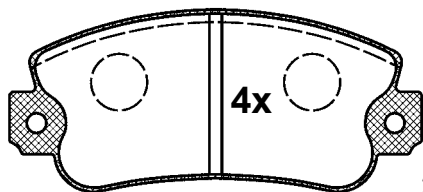

20775 18,0  
(20776)  
(20777)

108,9 x 47,4 x 18,0

# Abbildungen Scheibenbremsbeläge

Illustrations plaquettes de frein à disque / Illustrazioni pastiglie freno /  
Figuras Calços do travão de disco / Rysunki okładzin hamulców tarczowych /  
Zobrazení obložení kotoučových brzd

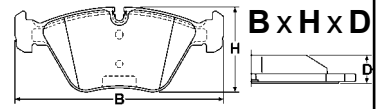

Maßstab - échelle - scala - escala - skala - měřítko 1:2

## BA2071

FIAT

BDX

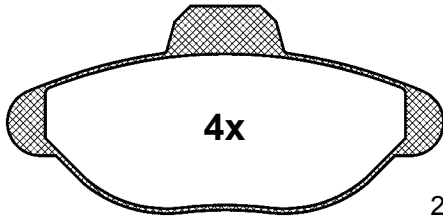

21365 17,0

115,0 x 54,8 x 17,0

## BA2074

CITROEN, PEUGEOT

BDX

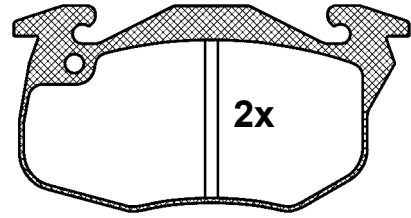

20905 18,0

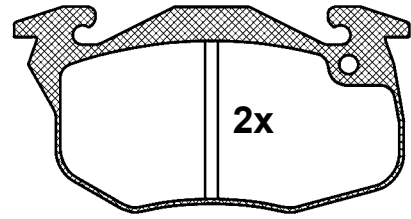

20906 18,0

105,1 x 54,4 x 18,0

280mm 2x

375mm 2x

## BA2072

FIAT, LANCIA

BDX

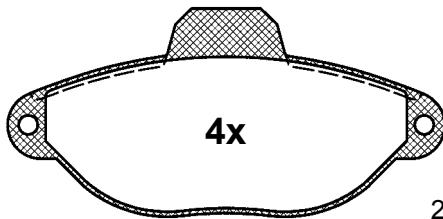

21436 17,0

115,0 x 55,2 x 17,0

## BA2075

RENAULT

BDX

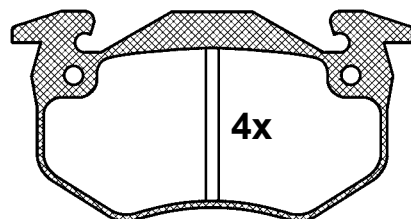

20634 15,0

105,1 x 54,9 x 15,0

## BA2073

FIAT, LANCIA

BDX

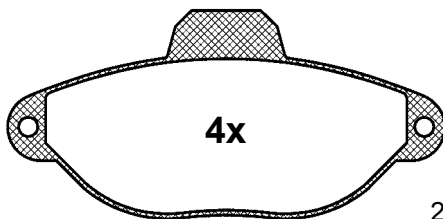

21436 17,0

115,0 x 55,2 x 17,0

475mm 2x

## BA2076

CITROEN, PEUGEOT, RENAULT

BDX

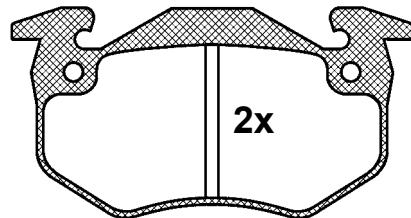

20973 11,0

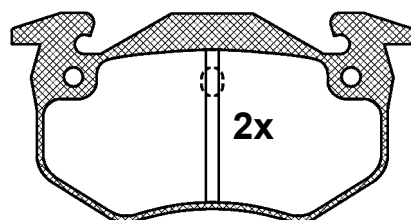

20974 11,0

105,1 x 54,9 x 11,0

# Abbildungen Scheibenbremsbeläge

Illustrations plaquettes de frein à disque / Illustrazioni pastiglie freno /

Figuras Calços do travão de disco / Rysunki okładzin hamulców tarczowych /

Zobrazení obložení kotoučových brzd

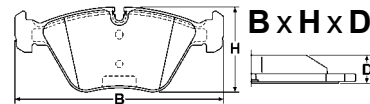

Maßstab - échelle - scala - escala - skala - měřítko 1:2

## BA2077



RENAULT

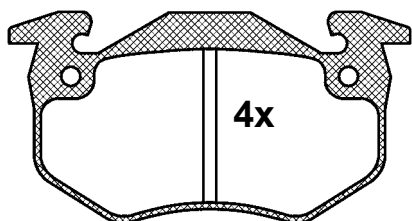

20634 15,0  
(21096)  
(21097)

105,1 x 54,9 x 15,0

205mm 2x

## BA2079



CITROEN, FIAT, PEUGEOT

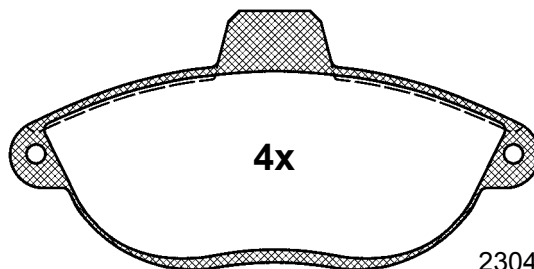

23042 18,7

139,7 x 68,7 x 18,7

280mm 2x

## BA2080



FORD

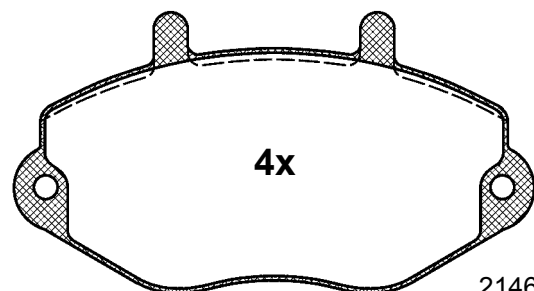

21469 19,0

139,0 x 72,0 x 19,0

## BA2078



CITROEN

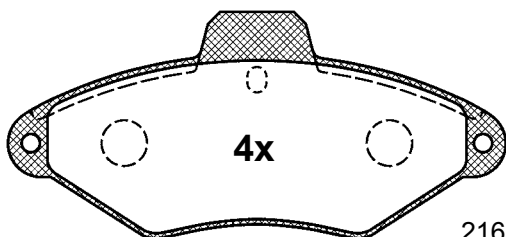

21631 17,0

131,0 x 60,7 x 17,0

155mm 2x

365mm 2x

## BA2081



FORD

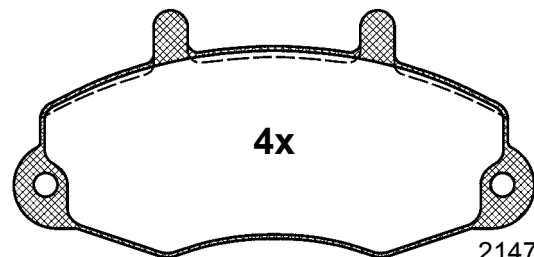

21470 19,0

138,9 x 64,1 x 19,0

# Abbildungen Scheibenbremsbeläge

Illustrations plaquettes de frein à disque / Illustrazioni pastiglie freno /  
 Figuras Calços do travão de disco / Rysunki okładzin hamulców tarczowych /  
 Zobrazení obložení kotoučových brzd

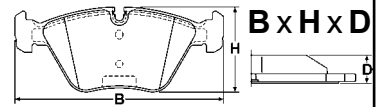

Maßstab - échelle - scala - escala - skala - měřítko 1:2

## BA2082



RENAULT, TALBOT

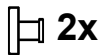
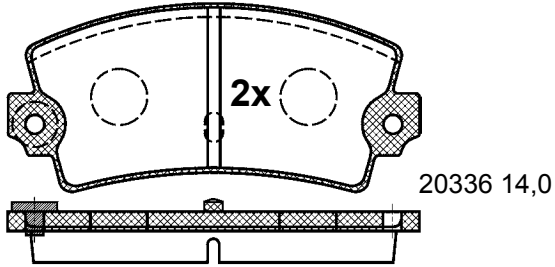

2x

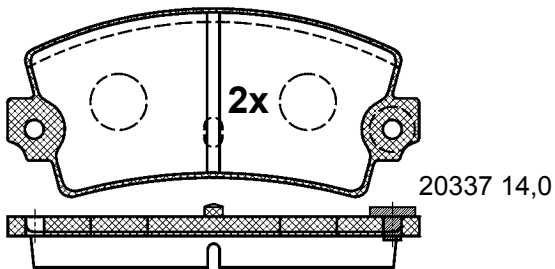

108,9 x 49,8 x 14,0

## BA2084



FORD

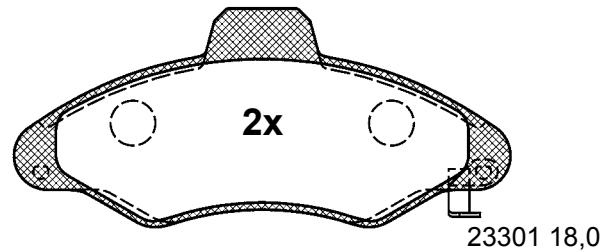
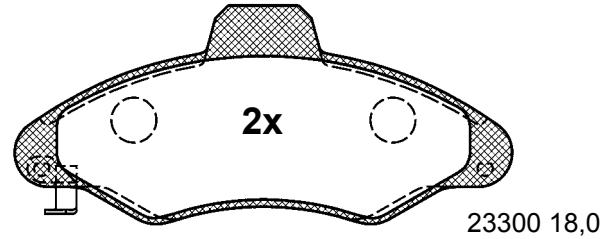

131,1 x 57,5 x 18,0

## BA2083



CITROEN, PEUGEOT

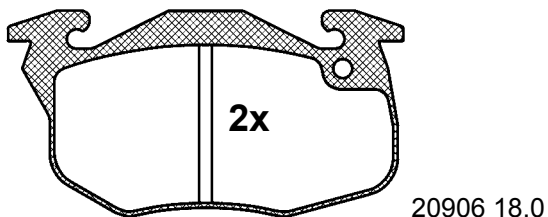
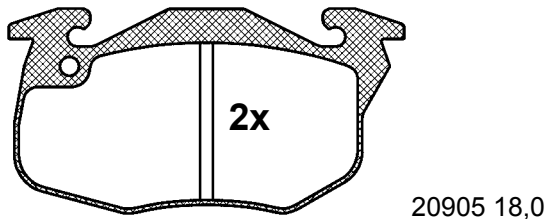

105,1 x 54,4 x 18,0

## BA2086



OPEL, RENAULT, VAUXHALL

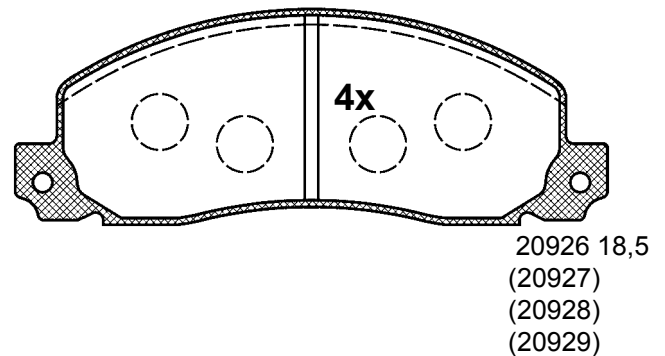

155,8 x 56,6 x 18,5

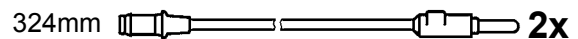

# Abbildungen Scheibenbremsbeläge

Illustrations plaquettes de frein à disque / Illustrazioni pastiglie freno /  
Figuras Calços do travão de disco / Rysunki okładzin hamulców tarczowych /  
Zobrazení obložení kotoučových brzd

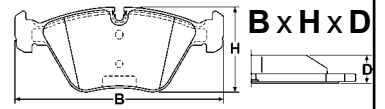

Maßstab - échelle - scala - escala - skala - měřítko 1:2

## BA2089



PEUGEOT



BOS

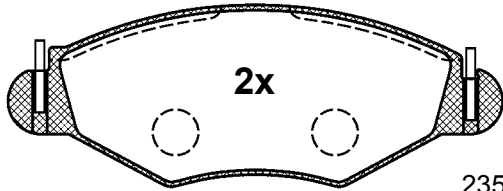

23597 18,0

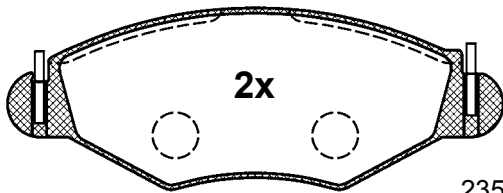

23598 18,0

2x



M8x20

131,0 x 47,3 x 18,0

## BA2091



MERCEDES BENZ



BOS

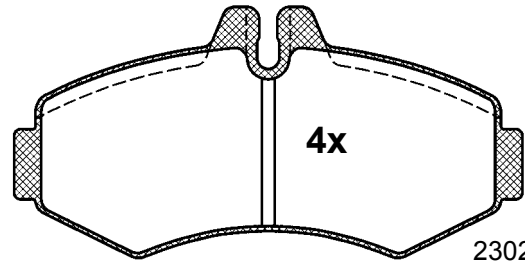

23022 20,9

134,6 x 64,4 x 20,9

## BA2093



MERCEDES BENZ



ATE

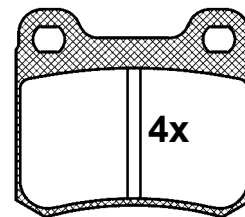

20687 13,5

61,7 x 54,4 x 13,5

## BA2090



CITROEN, NISSAN, RENAULT



BOS

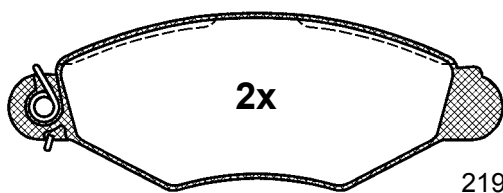

21980 18,0

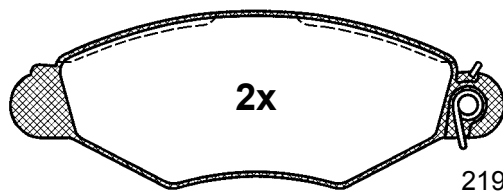

21981 18,0

2x



M8x20

130,8 x 47,2 x 18,0

## BA2094



MERCEDES BENZ



ATE

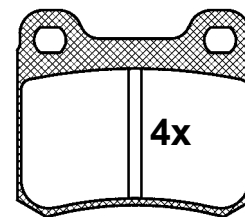

20687 15,5

61,7 x 54,4 x 15,5



# Abbildungen Scheibenbremsbeläge

Illustrations plaquettes de frein à disque / Illustrazioni pastiglie freno /  
 Figuras Calços do travão de disco / Rysunki okładzin hamulców tarczowych /  
 Zobrazení obložení kotoučových brzd

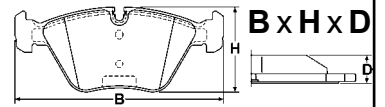

Maßstab - échelle - scala - escala - skala - měřítko 1:2

## BA2095



OPEL, SAAB, VAUXHALL

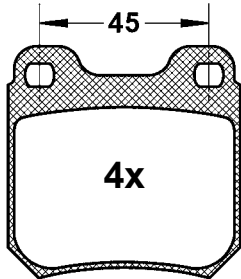

21050 15,7

61,8 x 61,3 x 15,7

## BA2097



CITROEN, PEUGEOT

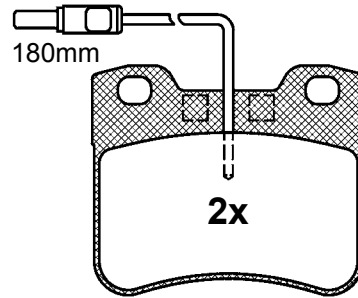

21191 17,0

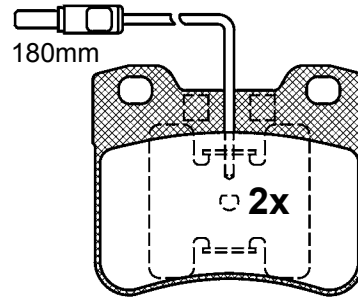

21267 17,0

72,1 x 60,5 x 17,0

## BA2096



CITROEN

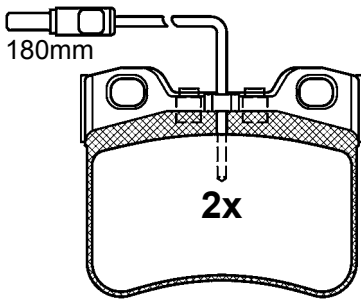

21179 16,8

72,1 x 60,5 x 16,8

## BA2098



OPEL, SAAB, VAUXHALL

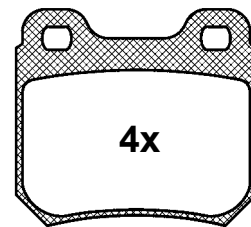

21140 15,7

61,6 x 57,4 x 15,7

## BA2099



PEUGEOT

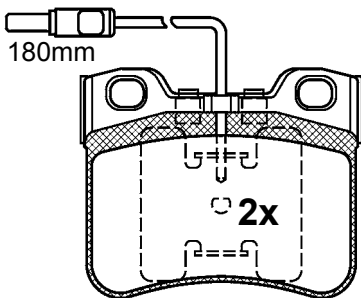

21289 16,8

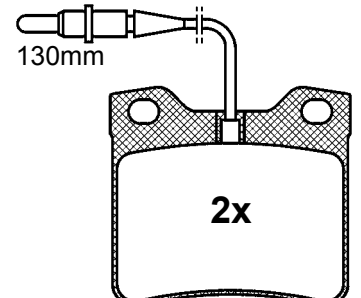

21278 17,0

21279 17,0

63,6 x 57,1 x 17,0

# Abbildungen Scheibenbremsbeläge

Illustrations plaquettes de frein à disque / Illustrazioni pastiglie freno /

Figuras Calços do travão de disco / Rysunki okładzin hamulców tarczowych /

Zobrazení obložení kotoučových brzd

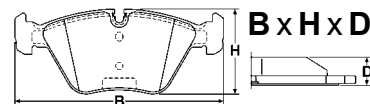

Maßstab - échelle - scala - escala - skala - měřítko 1:2

## BA2100



CITROEN, PEUGEOT



ATE

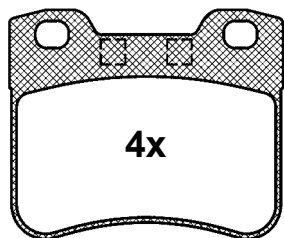

21857 16,8

72,1 x 60,5 x 16,8

## BA2107



RENAULT



BRE

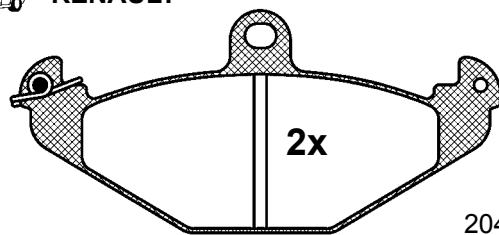

20410 15,0

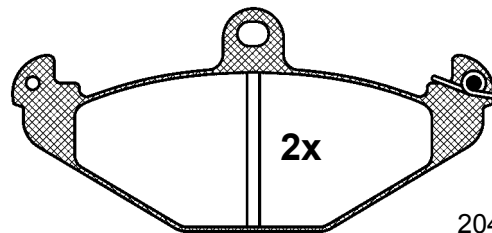

20423 15,0

125,9 x 58,4 x 15,0

## BA2101



MERCEDES BENZ



ATE

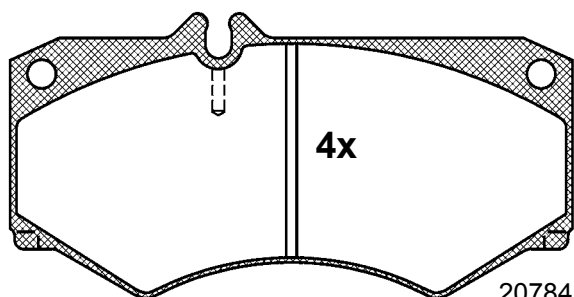

20784 18,0

149,1 x 75,0 x 18,0

## BA2108



BMW



ATE

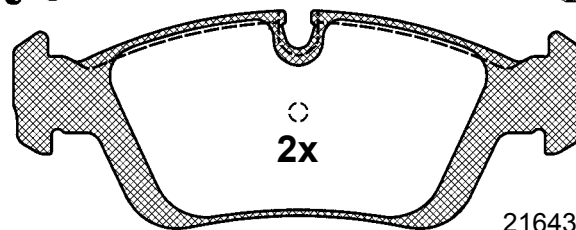

21643 17,8

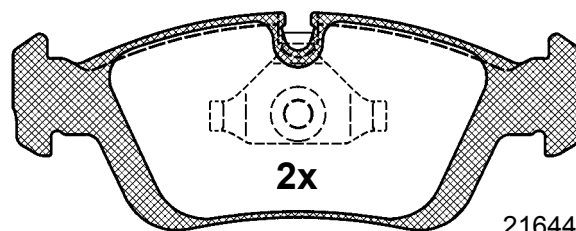

21644 17,8

151,4 x 57,7 x 17,8

## BA2106



CITROEN



CIT

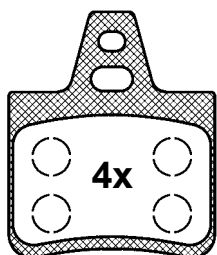

20162 15,4

53,8 x 64,9 x 15,4

## BA2109



VOLKSWAGEN



ATE

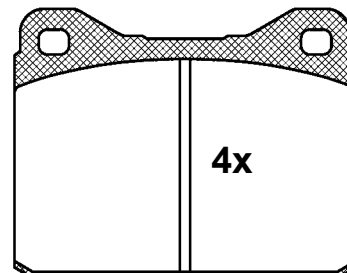

20280 18,5

89,6 x 73,9 x 18,5

# Abbildungen Scheibenbremsbeläge

Illustrations plaquettes de frein à disque / Illustrazioni pastiglie freno /  
Figuras Calços do travão de disco / Rysunki okładzin hamulców tarczowych /  
Zobrazení obložení kotoučových brzd

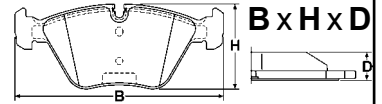

Maßstab - échelle - scala - escala - skala - měřítko 1:2

## BA2110



FORD, MAZDA

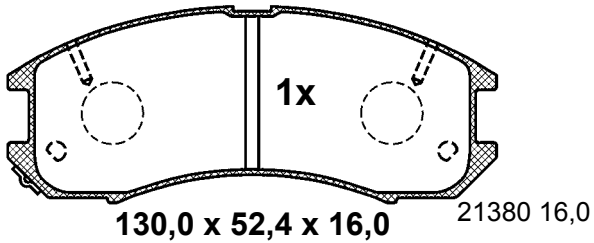
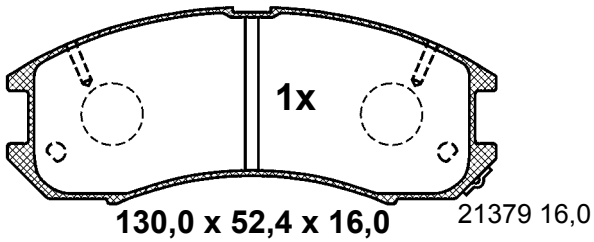
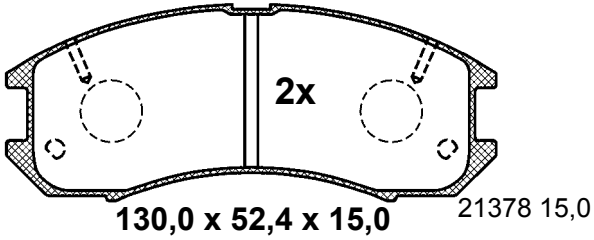

## BA2112



MITSUBISHI

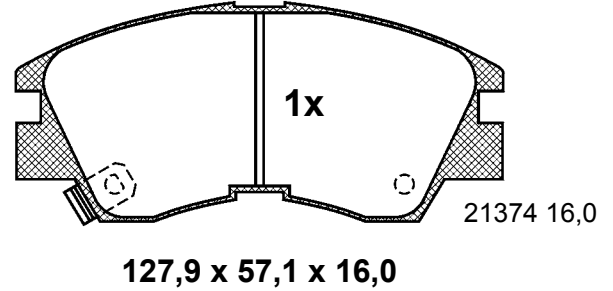
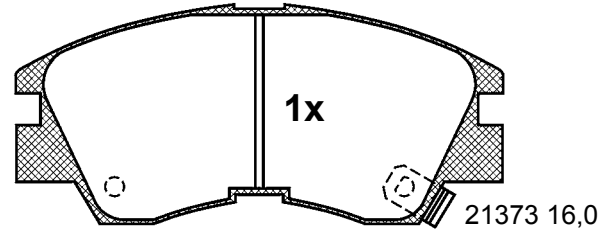
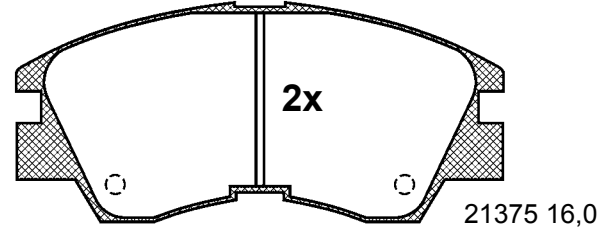

## BA2111



HONDA, HYUNDAI

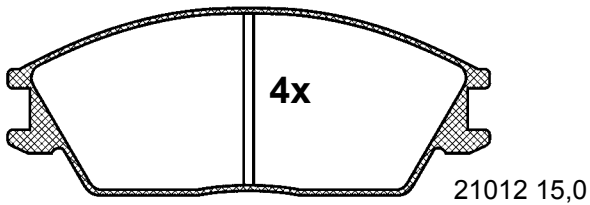

127,0 x 49,0 x 15,0

## BA2113



NISSAN

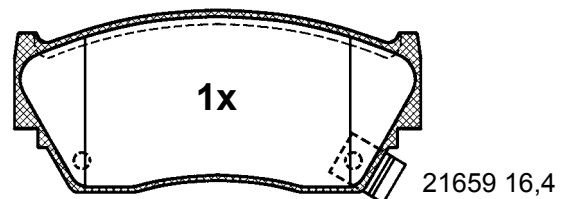
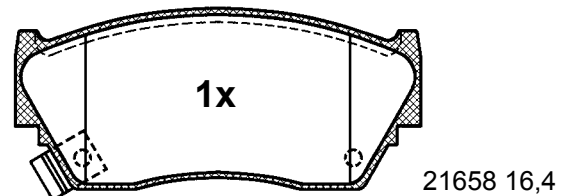
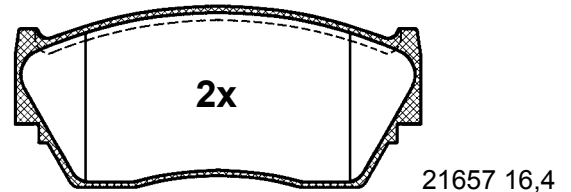

108,3 x 47,9 x 16,4

# Abbildungen Scheibenbremsbeläge

Illustrations plaquettes de frein à disque / Illustrazioni pastiglie freno /

Figuras Calços do travão de disco / Rysunki okładzin hamulców tarczowych /

Zobrazení obložení kotoučových brzd

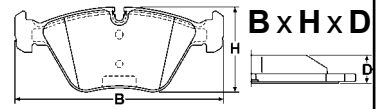

Maßstab - échelle - scala - escala - skala - měřítko 1:2

## BA2114



ISUZU, OPEL, VAUXHALL



AKE

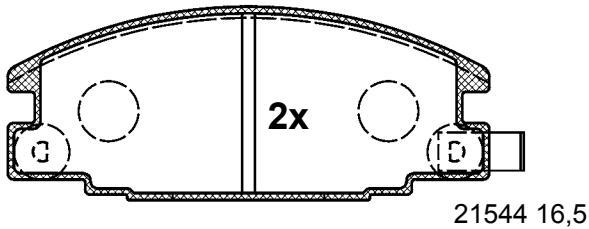
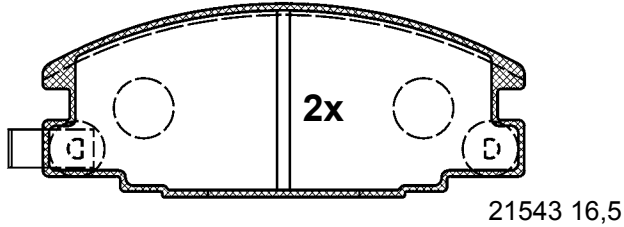

127,1 x 50,9 x 16,5

## BA2116



TOYOTA



SUM

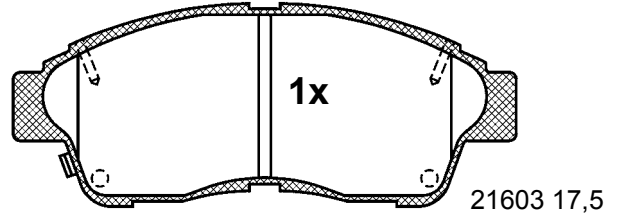
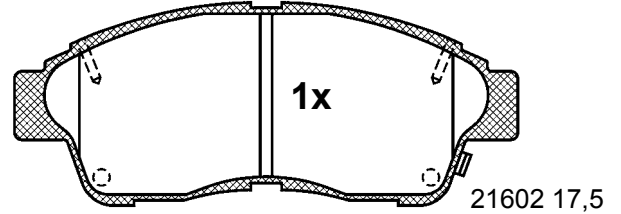
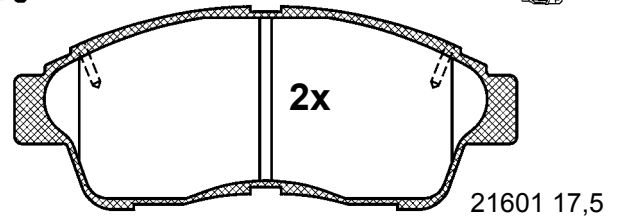

132,9 x 53,0 x 17,5

## BA2115



KIA, MAZDA



SUM

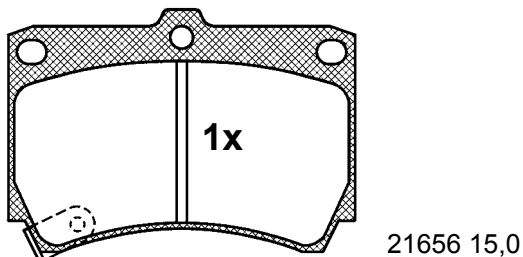
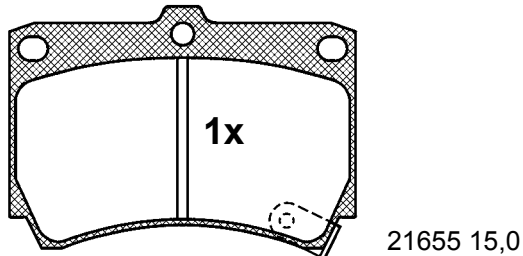
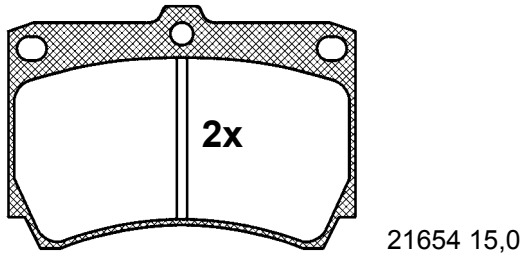

91,6 x 64,0 x 15,0

## BA2117



MITSUBISHI, PROTON



SUM

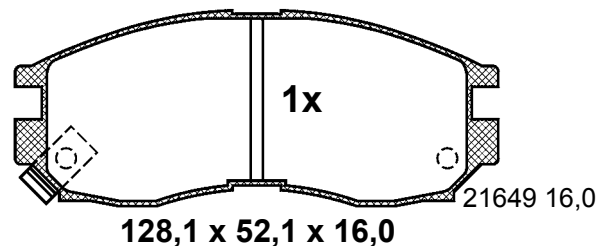
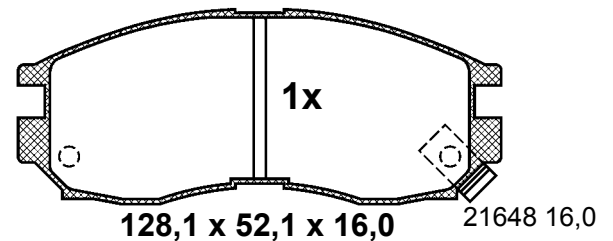
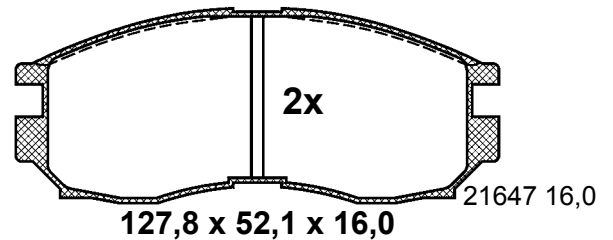

# Abbildungen Scheibenbremsbeläge

Illustrations plaquettes de frein à disque / Illustrazioni pastiglie freno /  
Figuras Calços do travão de disco / Rysunki okładzin hamulców tarczowych /  
Zobrazení obložení kotoučových brzd

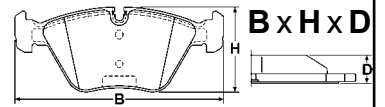

Maßstab - échelle - scala - escala - skala - měřítko 1:2

## BA2118



FORD, MAZDA



SUM

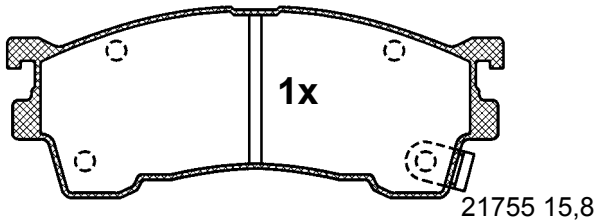
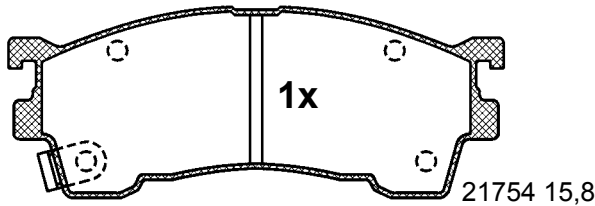
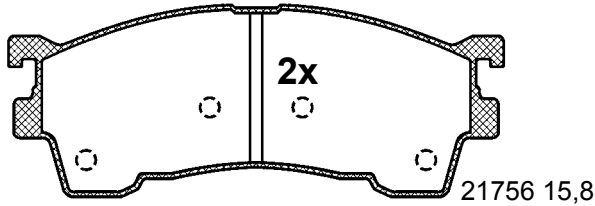

132,1 x 51,6 x 15,8

## BA2121



TOYOTA



AKE

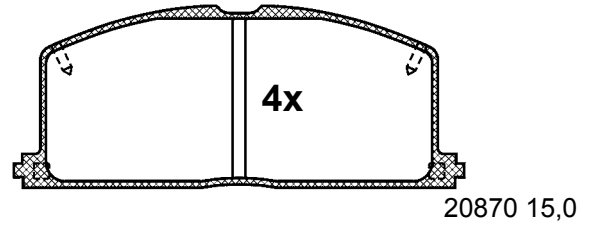

119,8 x 47,6 x 15,0

## BA2122



DAEWOO



AKE

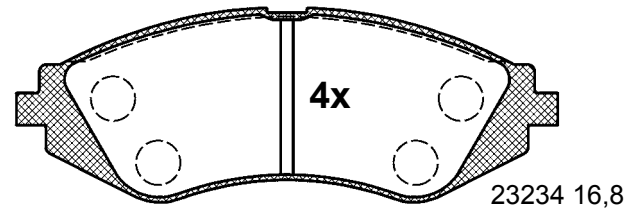

143,0 x 51,4 x 16,8

## BA2119



FORD, NISSAN



LUC

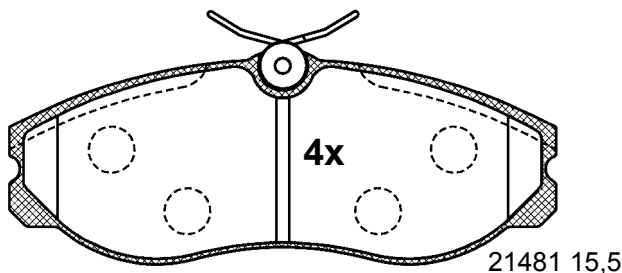

144,9 x 55,6 x 15,5

## BA2123



CHEVROLET, DAEWOO

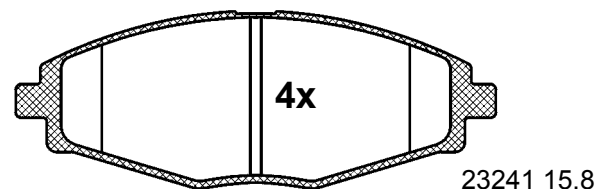

127,1 x 48,2 x 15,8

## BA2124



MERCEDES BENZ



ATE

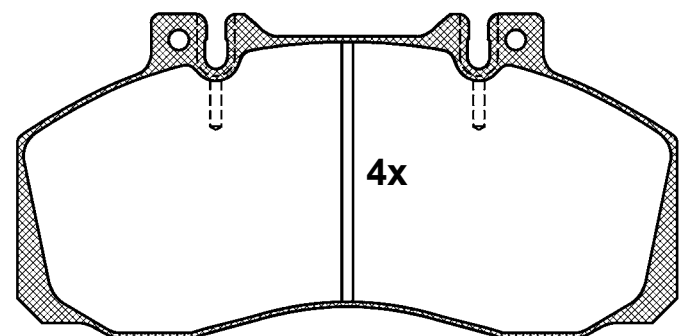

174,9 x 85,7 x 22,0

# Abbildungen Scheibenbremsbeläge

Illustrations plaquettes de frein à disque / Illustrazioni pastiglie freno /  
Figuras Calços do travão de disco / Rysunki okładzin hamulców tarczowych /  
Zobrazení obložení kotoučových brzd

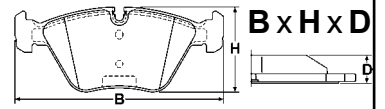

Maßstab - échelle - scala - escala - skala - měřítko 1:2

## BA2125

BMW

ATE

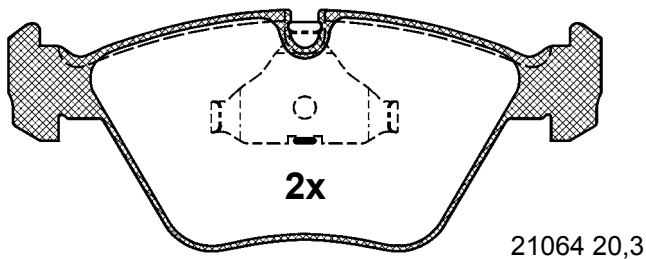
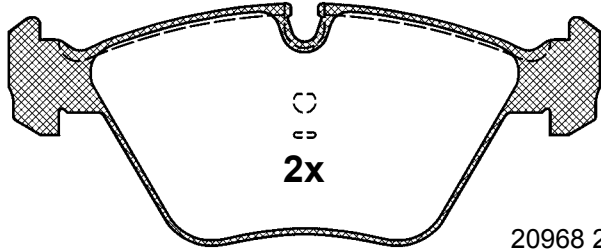

156,4 x 64,0 x 20,3

## BA2132

SEAT, VOLKSWAGEN

VW

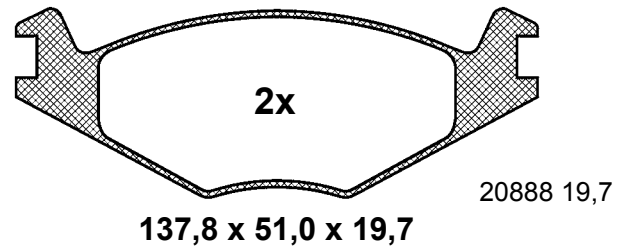
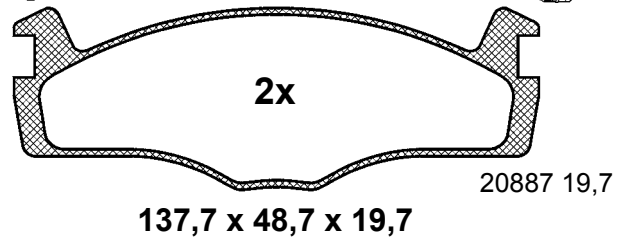

## BA2133

SEAT, VOLKSWAGEN

VW

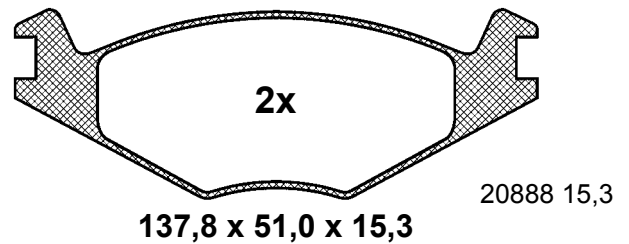
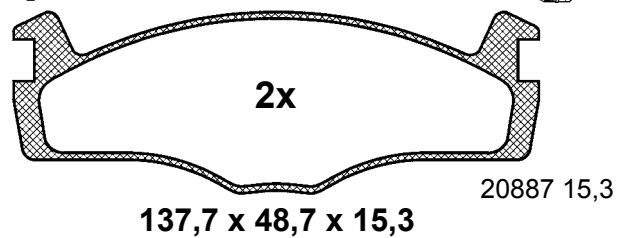

## BA2126

SKODA

ATE

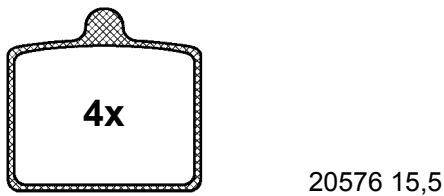

50,6 x 48,8 x 15,5

## BA2131

SEAT, VOLKSWAGEN

VW

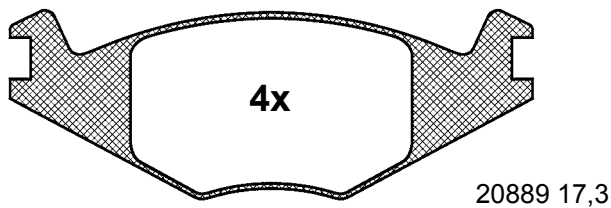

137,8 x 51,0 x 17,3



## BA2134

OPEL, VAUXHALL

DEL

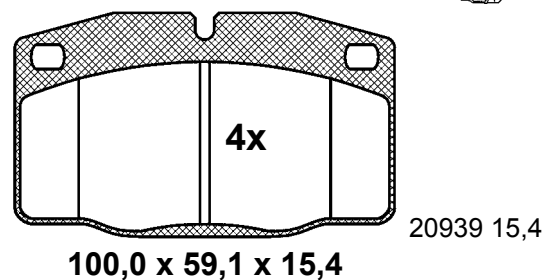

# Abbildungen Scheibenbremsbeläge

Illustrations plaquettes de frein à disque / Illustrazioni pastiglie freno /  
Figuras Calços do travão de disco / Rysunki okładzin hamulców tarczowych /  
Zobrazení obložení kotoučových brzd

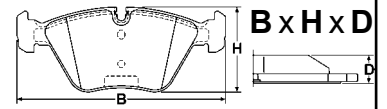

Maßstab - échelle - scala - escala - skala - měřítko 1:2

## BA2135

AUDI

ATE

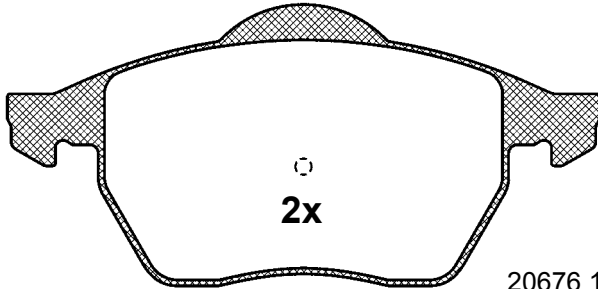

20676 19,5

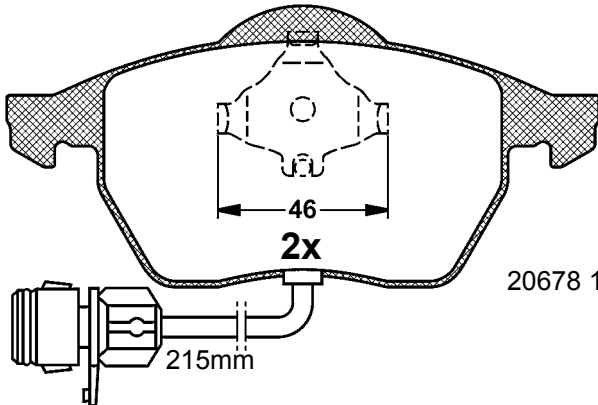

20678 19,5

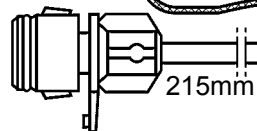

156,3 x 74,1 x 19,5

## BA2137

CHEVROLET, DAEWOO, OPEL,  
VAUXHALL

ATE

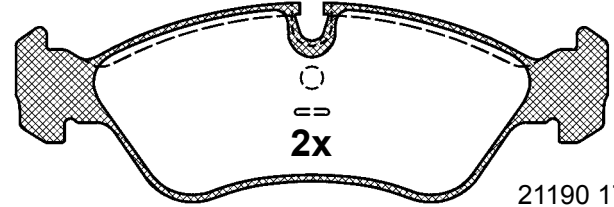

21190 17,5

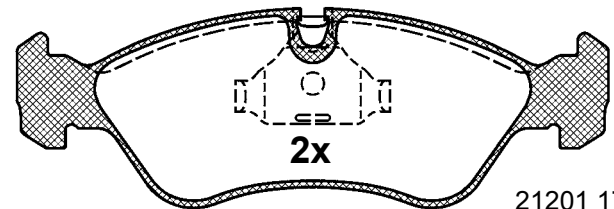

21201 17,5

156,4 x 52,6 x 17,5

## BA2136

CHEVROLET, DAEWOO, OPEL,  
VAUXHALL

ATE

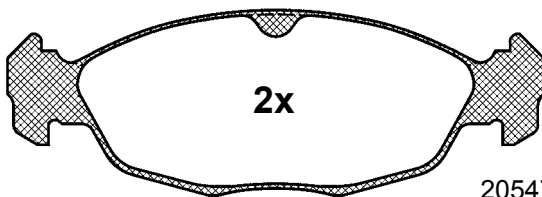

20547 16,8

141,3 x 48,1 x 16,8

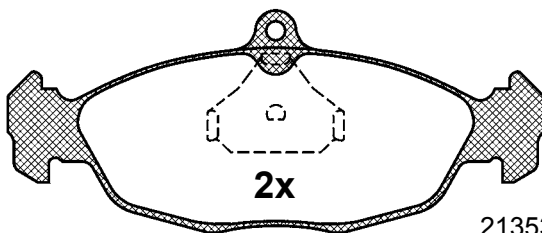

21353 16,8

140,1 x 58,3 x 16,8

## BA2138

FORD

ATE

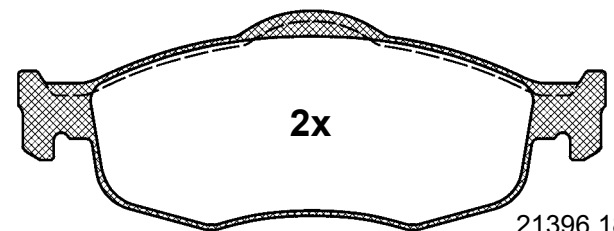

21396 18,0

156,4 x 58,6 x 18,0

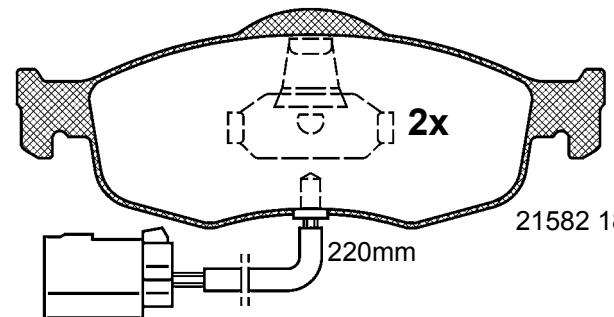

21582 18,0

155,2 x 58,6 x 18,0

# Abbildungen Scheibenbremsbeläge

Illustrations plaquettes de frein à disque / Illustrazioni pastiglie freno /

Figuras Calços do travão de disco / Rysunki okładzin hamulców tarczowych /

Zobrazení obložení kotoučových brzd

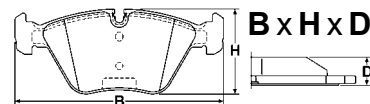

Maßstab - échelle - scala - escala - skala - měřítko 1:2

## BA2139

FORD

ATE

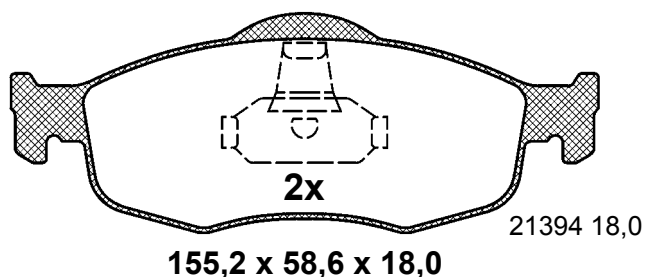
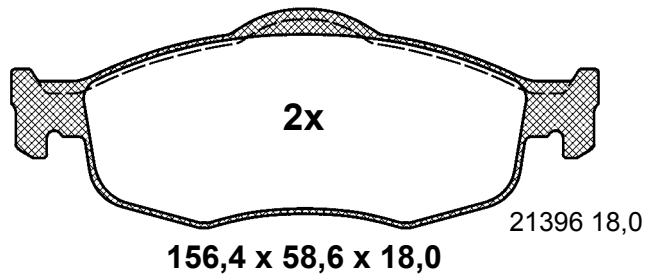

## BA2141

SEAT, VOLKSWAGEN

VW

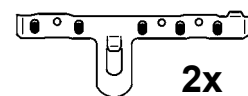
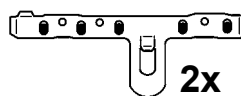
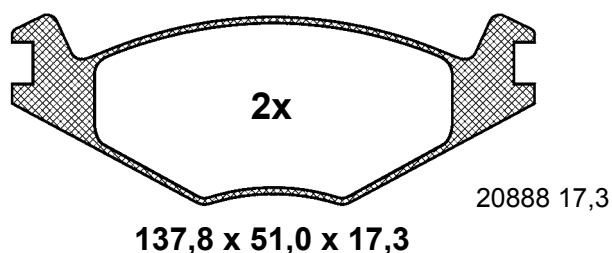
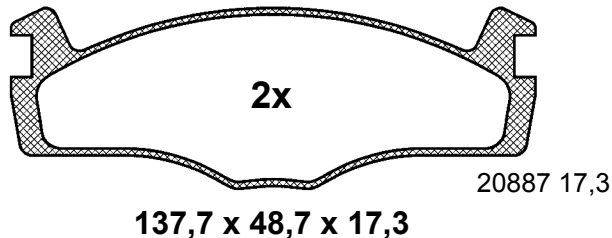

## BA2140

PEUGEOT

ATE

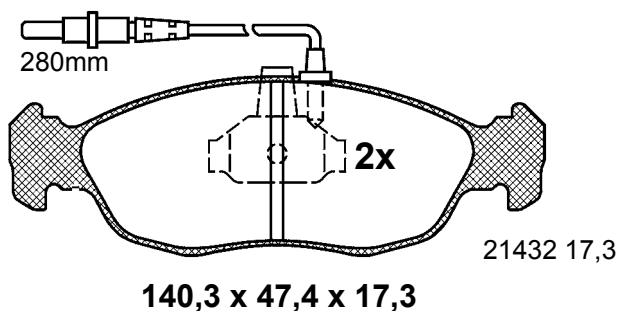
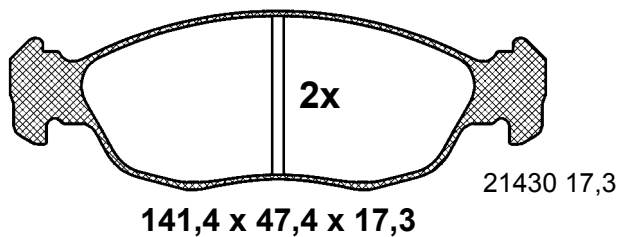

## BA2142

FIAT, LANCIA

ATE

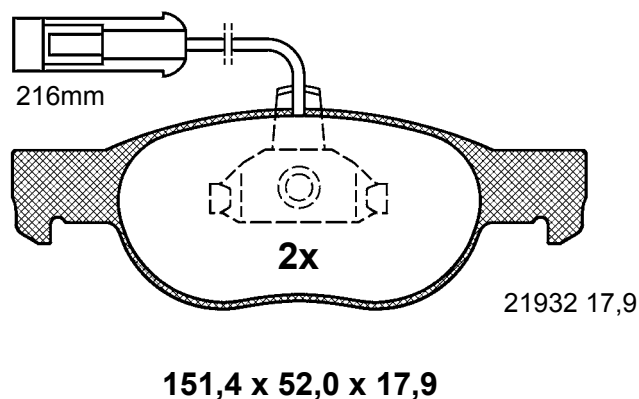
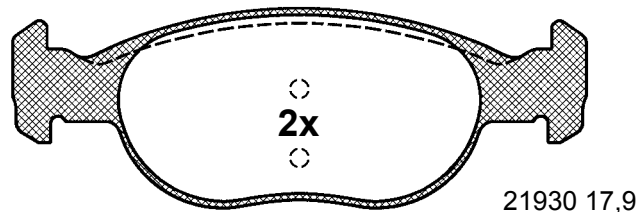



# Abbildungen Scheibenbremsbeläge

Illustrations plaquettes de frein à disque / Illustrazioni pastiglie freno /  
 Figuras Calços do travão de disco / Rysunki okładzin hamulców tarczowych /  
 Zobrazení obložení kotoučových brzd

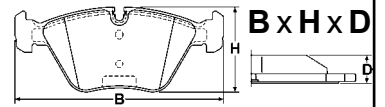

Maßstab - échelle - scala - escala - skala - měřítko 1:2

## BA2143



FIAT, LANCIA



ATE

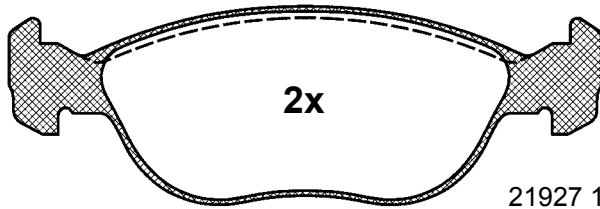

21927 17,9

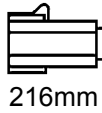

216mm

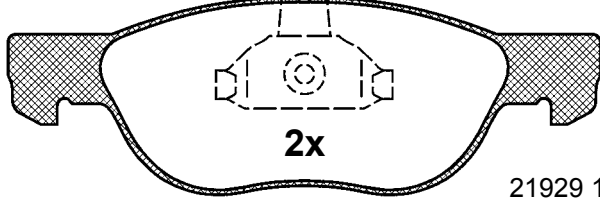

21929 17,9

156,4 x 52,6 x 17,9

## BA2145



SEAT, VOLKSWAGEN



VW

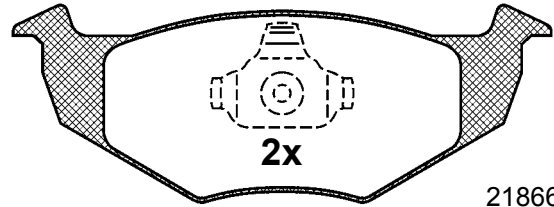

21866 19,7

141,7 x 50,8 x 19,7

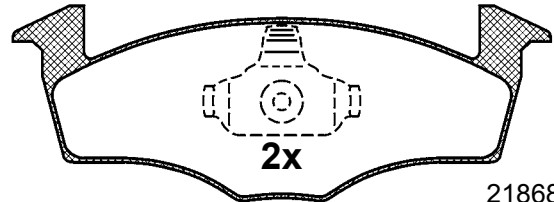

21868 19,7

141,7 x 50,5 x 19,7

## BA2144



FORD, MAZDA



ATE

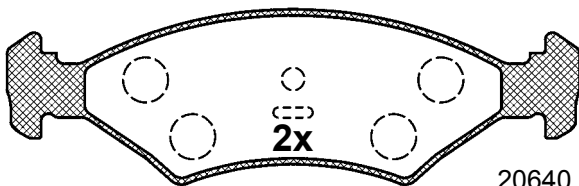

20640 18,0

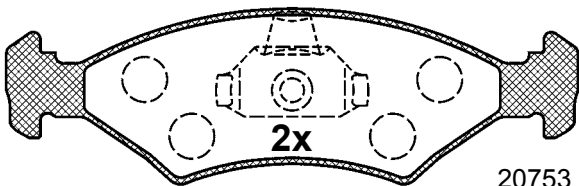

20753 18,0

151,4 x 46,1 x 18,0

## BA2146



FORD, MAZDA



ATE

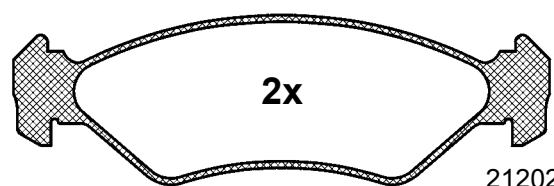

21202 17,0

141,4 x 44,5 x 17,0

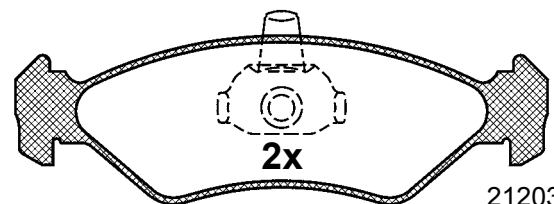

21203 17,0

140,1 x 44,5 x 17,0

# Abbildungen Scheibenbremsbeläge

Illustrations plaquettes de frein à disque / Illustrazioni pastiglie freno /  
Figuras Calços do travão de disco / Rysunki okładzin hamulców tarczowych /  
Zobrazení obložení kotoučových brzd

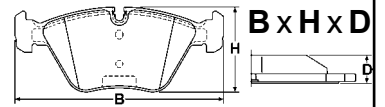

Maßstab - échelle - scala - escala - skala - měřítko 1:2

## BA2147



FORD, SEAT, VOLKSWAGEN

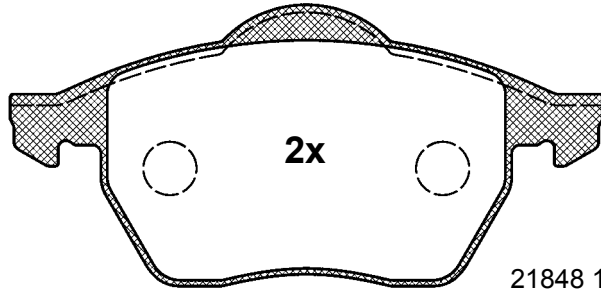

21848 19,5

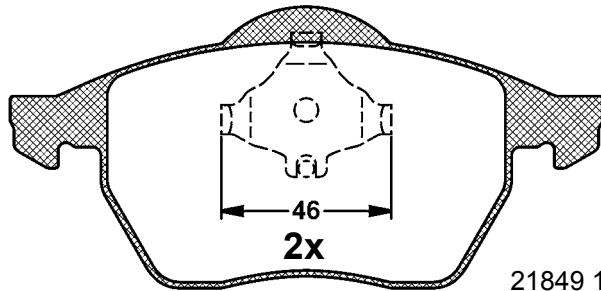

21849 19,5

156,3 x 74,2 x 19,5

## BA2149



MERCEDES BENZ, VOLKSWAGEN

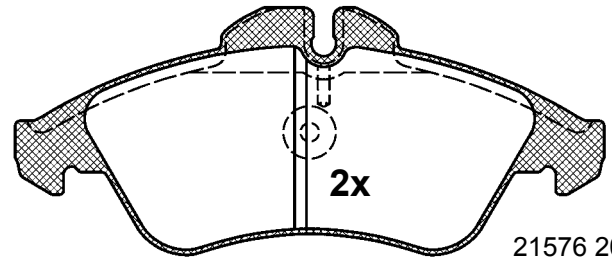

21576 20,5

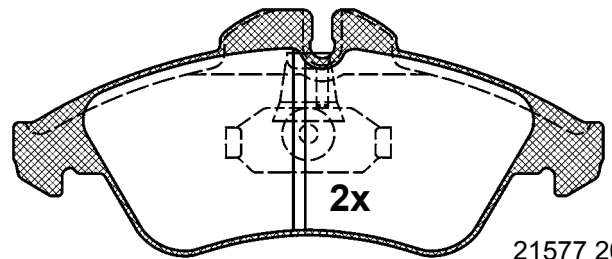

21577 20,5

156,4 x 64,9 x 20,5

## BA2148



AUDI, VOLKSWAGEN

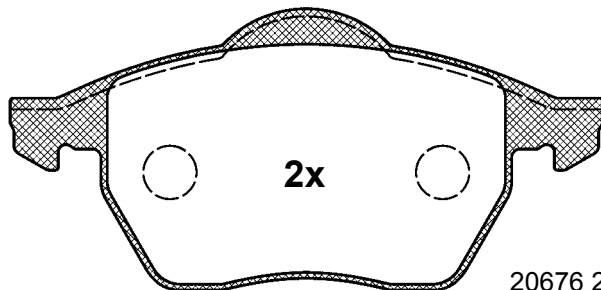

20676 20,6

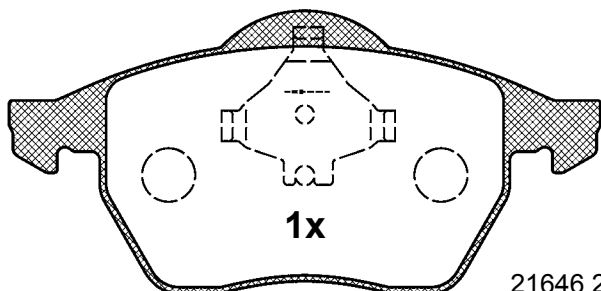

21646 20,6

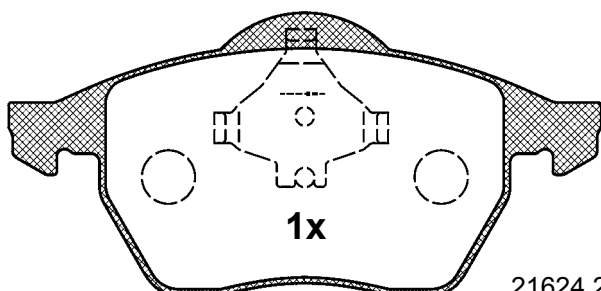

21624 20,6

156,3 x 74,1 x 20,6

## BA2150



MERCEDES BENZ

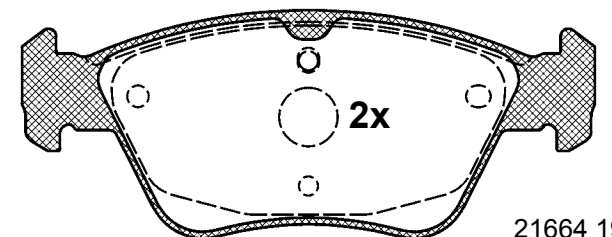

21664 19,1

151,4 x 60,1 x 19,1

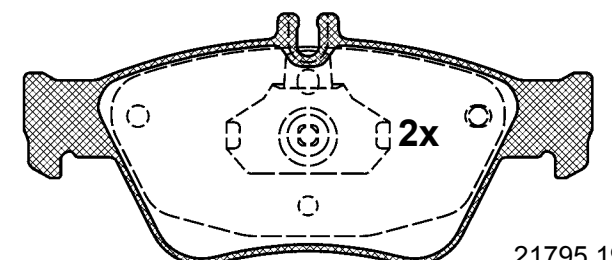

21795 19,1

150,3 x 66,2 x 19,1

# Abbildungen Scheibenbremsbeläge

Illustrations plaquettes de frein à disque / Illustrazioni pastiglie freno /  
Figuras Calços do travão de disco / Rysunki okładzin hamulców tarczowych /  
Zobrazení obložení kotoučových brzd

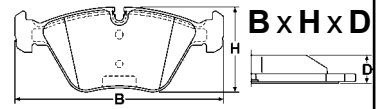

Maßstab - échelle - scala - escala - skala - měřítko 1:2

## BA2151



CITROËN, PEUGEOT



ATE

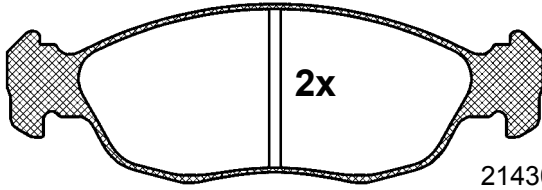

2x

21430 17,3

141,4 x 47,4 x 17,3

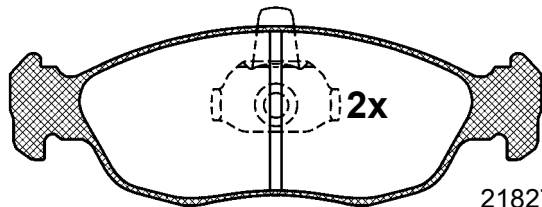

2x

21827 17,3

140,3 x 47,4 x 17,3

## BA2153



SEAT, VOLKSWAGEN



VW

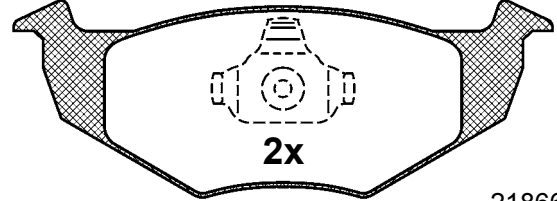

2x

21866 15,3

141,7 x 50,8 x 15,3

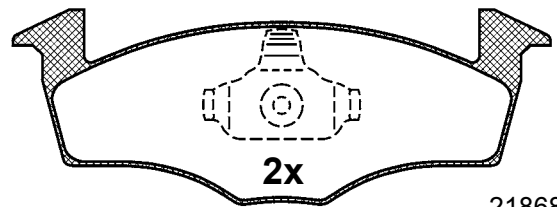

2x

21868 15,3

141,7 x 50,5 x 15,3

## BA2152



SEAT, SKODA, VOLKSWAGEN



VW

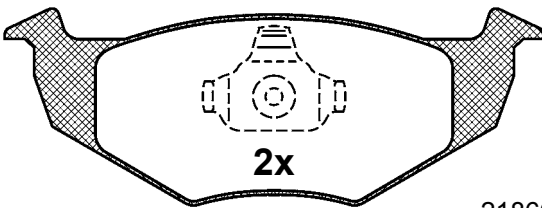

2x

21866 17,3

141,7 x 50,8 x 17,3

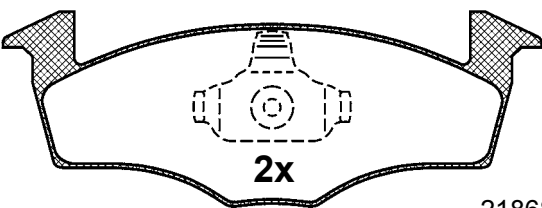

2x

21868 17,3

141,7 x 50,5 x 17,3

## BA2154



AUDI, SEAT, SKODA,  
VOLKSWAGEN



VW

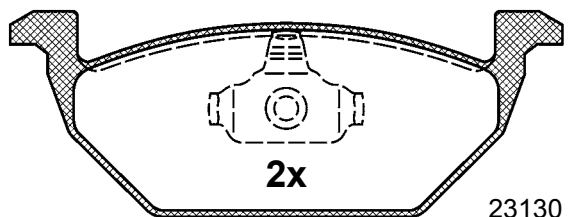

2x

23130 19,6

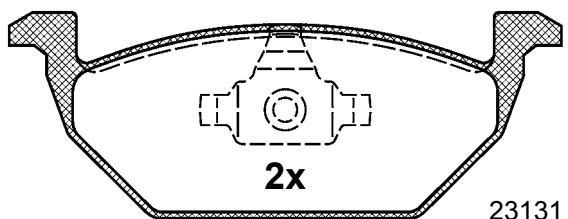

2x

23131 19,6

146,1 x 54,8 x 19,6

# Abbildungen Scheibenbremsbeläge

Illustrations plaquettes de frein à disque / Illustrazioni pastiglie freno /

Figuras Calços do travão de disco / Rysunki okładzin hamulców tarczowych /

Zobrazení obložení kotoučových brzd

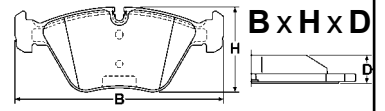

Maßstab - échelle - scala - escala - skala - měřítko 1:2

## BA2155



AUDI, SEAT, SKODA,  
VOLKSWAGEN



VW

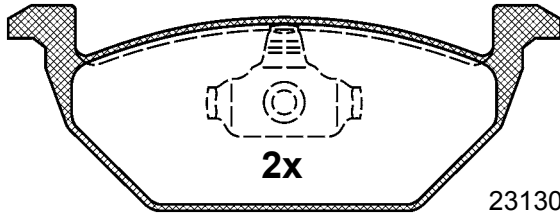

23130 19,6

## BA2160



AUDI, VOLKSWAGEN



LUC

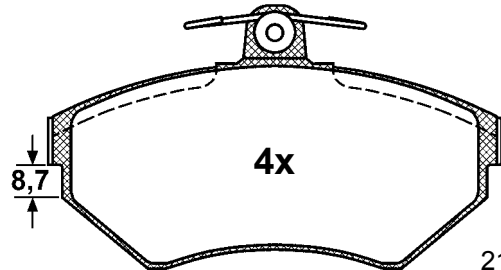

21945 19,6



118,8 x 69,6 x 19,6

## BA2161



MERCEDES BENZ



ATE

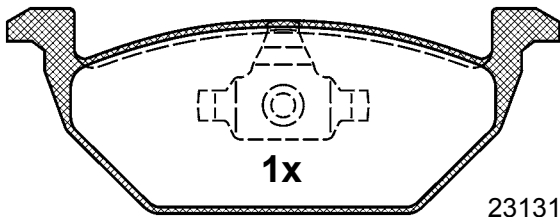

23131 19,6

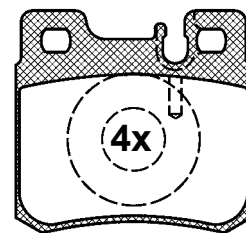

21197 15,0

61,7 x 58,4 x 15,0

## BA2162



MERCEDES BENZ, VOLVO



ATE

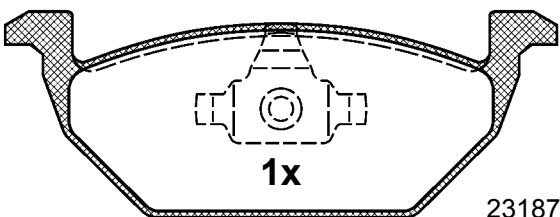

23187 19,6

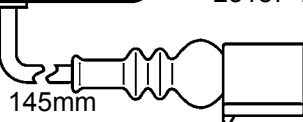

146,1 x 54,8 x 19,6

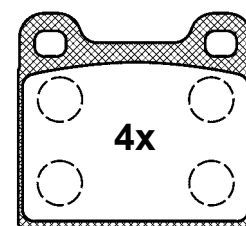

21035 15,5

61,8 x 56,6 x 15,5

# Abbildungen Scheibenbremsbeläge

Illustrations plaquettes de frein à disque / Illustrazioni pastiglie freno /  
 Figuras Calços do travão de disco / Rysunki okładzin hamulców tarczowych /  
 Zobrazení obložení kotoučových brzd

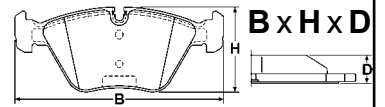

Maßstab - échelle - scala - escala - skala - měřítko 1:2

## BA2163



CHRYSLER, MERCEDES BENZ

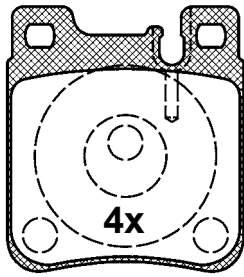

21305 15,5

61,7 x 69,7 x 15,5

## BA2166



BMW

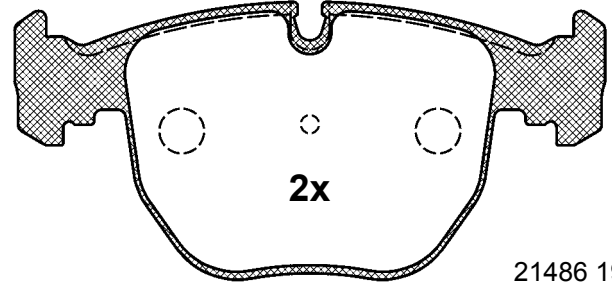

21486 19,3

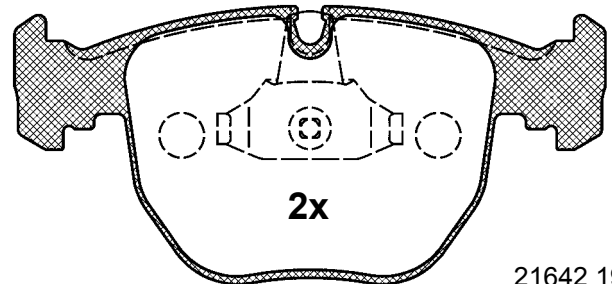

21642 19,3

156,4 x 73,4 x 19,3

## BA2164



CHRYSLER, MERCEDES BENZ

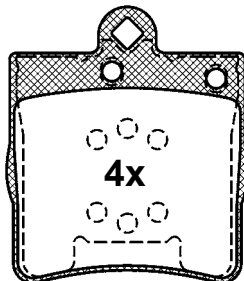

21919 15,8

63,7 x 72,9 x 15,8

## BA2167



BMW, LAND ROVER

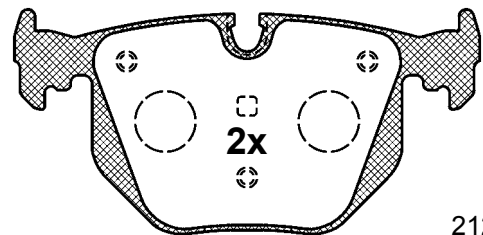

21282 17,3

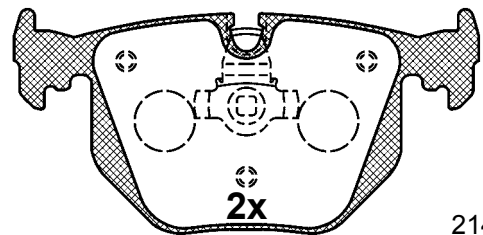

21487 17,3

123,2 x 59,5 x 17,3

# Abbildungen Scheibenbremsbeläge

Illustrations plaquettes de frein à disque / Illustrazioni pastiglie freno /

Figuras Calços do travão de disco / Rysunki okładzin hamulców tarczowych /

Zobrazení obložení kotoučových brzd

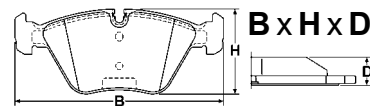

Maßstab - échelle - scala - escala - skala - měřítko 1:2

## BA2168



CHRYSLER, MERCEDES BENZ



ATE

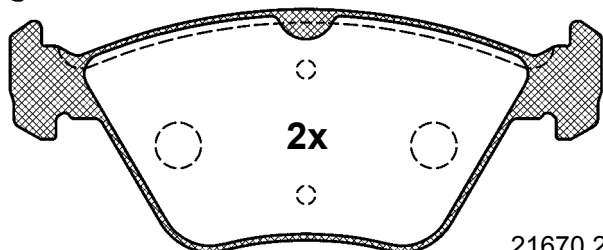

156,4 x 63,7 x 20,3

21670 20,3

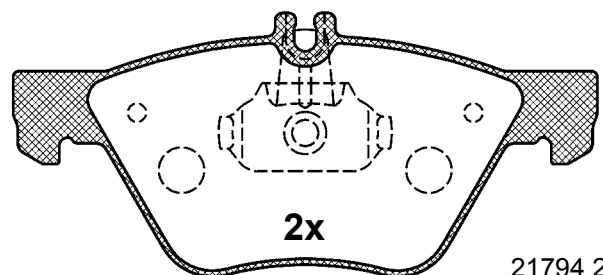

155,3 x 69,6 x 20,3

21794 20,3

## BA2170



BMW



ATE

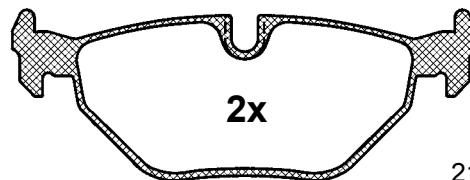

123,0 x 44,8 x 17,3

21891 17,3

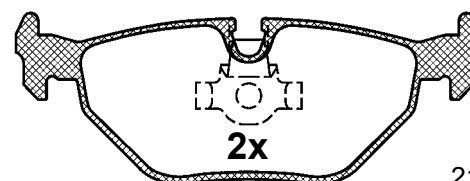

122,0 x 44,8 x 17,3

21691 17,3

## BA2169



BMW



ATE

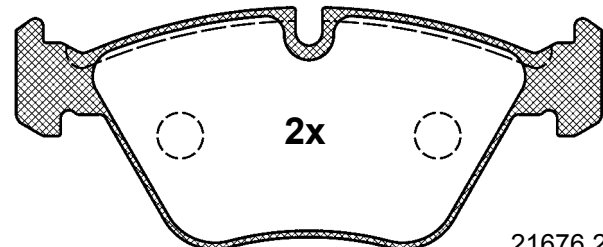

154,6 x 63,6 x 20,3

21676 20,3

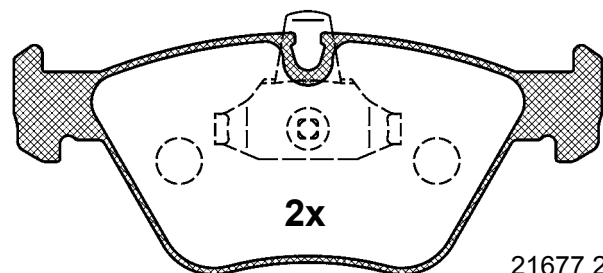

155,1 x 63,6 x 20,3

21677 20,3

## BA2171



VOLKSWAGEN



ATE

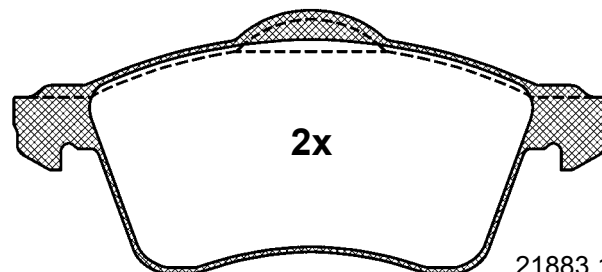

21883 19,6

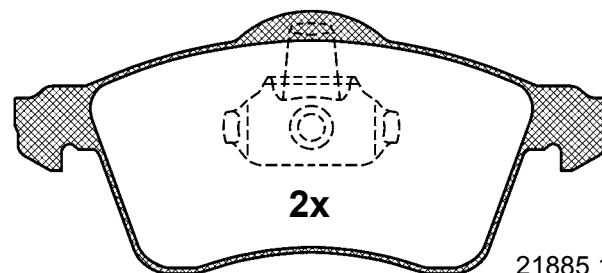

21885 19,6

156,2 x 68,6 x 19,6

# Abbildungen Scheibenbremsbeläge

Illustrations plaquettes de frein à disque / Illustrazioni pastiglie freno /  
Figuras Calços do travão de disco / Rysunki okładzin hamulców tarczowych /  
Zobrazení obložení kotoučových brzd

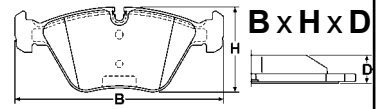

Maßstab - échelle - scala - escala - skala - měřítko 1:2

## BA2172



AUDI, SEAT, SKODA,  
VOLKSWAGEN

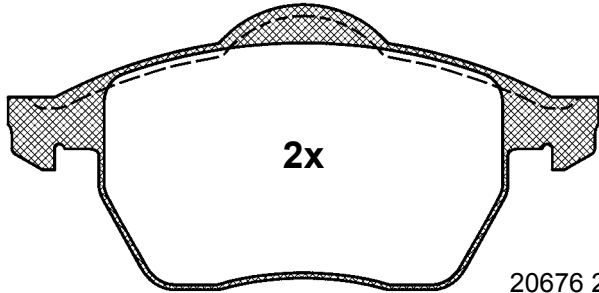

20676 20,6

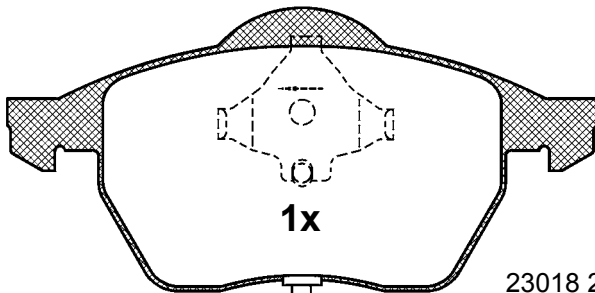

23018 20,6

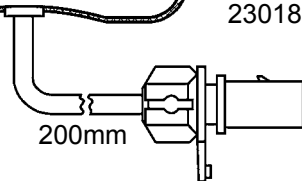

200mm

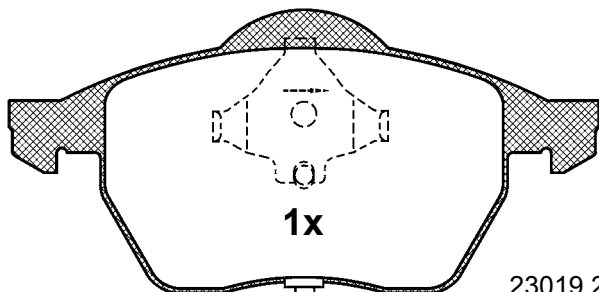

23019 20,6

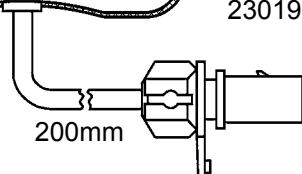

200mm

156,3 x 74,1 x 20,6

## BA2173



OPEL, VAUXHALL

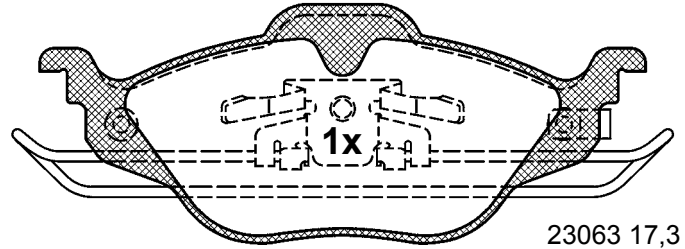

23063 17,3

160,0 x 63,0 x 17,3

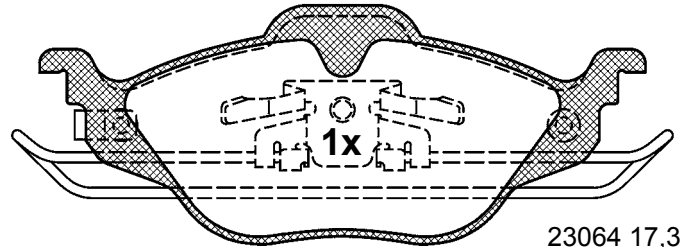

23064 17,3

160,0 x 63,0 x 17,3

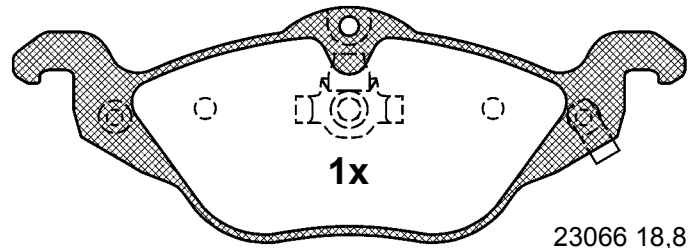

23066 18,8

177,6 x 62,1 x 18,8

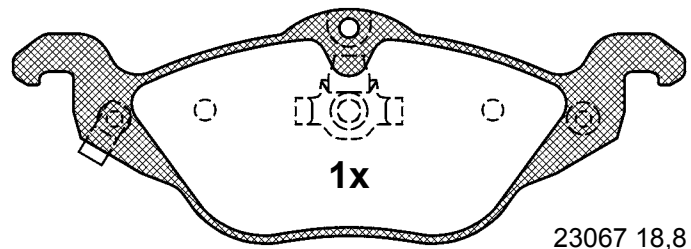

23067 18,8

177,6 x 62,1 x 18,8

# Abbildungen Scheibenbremsbeläge

Illustrations plaquettes de frein à disque / Illustrazioni pastiglie freno /  
Figuras Calços do travão de disco / Rysunki okładzin hamulców tarczowych /  
Zobrazení obložení kotoučových brzd

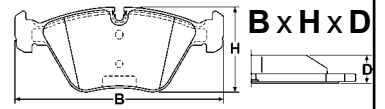

Maßstab - échelle - scala - escala - skala - měřítko 1:2

## BA2174



MERCEDES BENZ



ATE

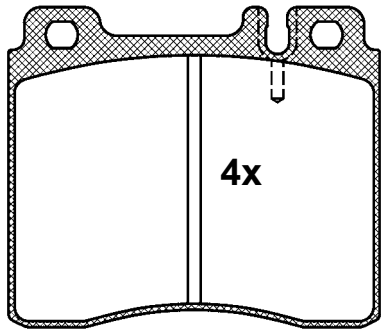

21303 18,8

99,5 x 84,5 x 18,8

## BA2177



MERCEDES BENZ



LUC

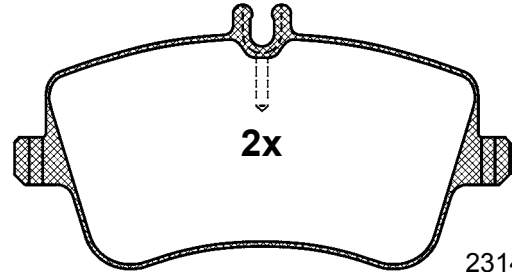

23144 19,8

131,0 x 69,9 x 19,8

## BA2175



OPEL, VAUXHALL



LUC

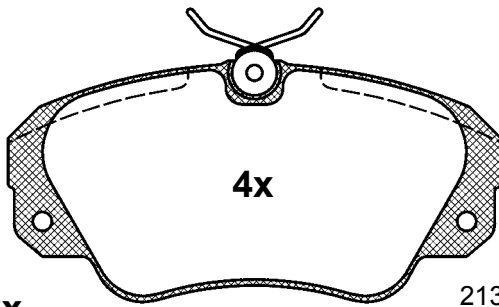

21368 18,3

129,9 x 64,0 x 18,3

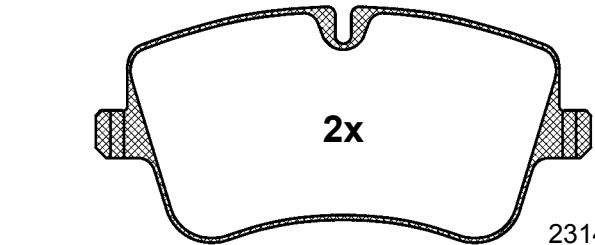

23145 19,8

131,0 x 62,2 x 19,8

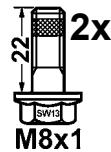

## BA2178



AUDI



LUC

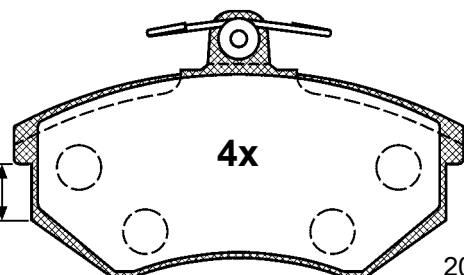

20669 16,3

119,0 x 69,6 x 16,3



## BA2176



MERCEDES BENZ



LUC

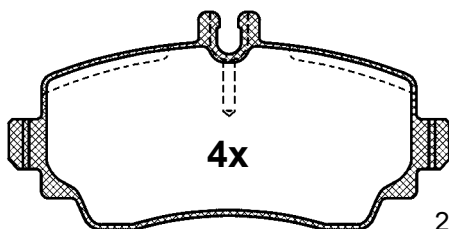

23070 17,0

116,5 x 57,1 x 17,0

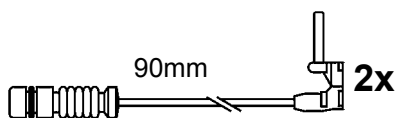
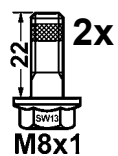



# Abbildungen Scheibenbremsbeläge

Illustrations plaquettes de frein à disque / Illustrazioni pastiglie freno /  
Figuras Calços do travão de disco / Rysunki okładzin hamulców tarczowych /  
Zobrazení obložení kotoučových brzd

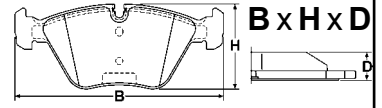

Maßstab - échelle - scala - escala - skala - měřítko 1:2

## BA2181

 VOLVO

 LUC

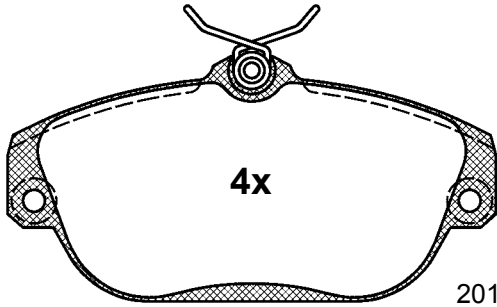

20164 18,2

129,0 x 64,8 x 18,2

## BA2184

 MERCEDES BENZ

 BRE

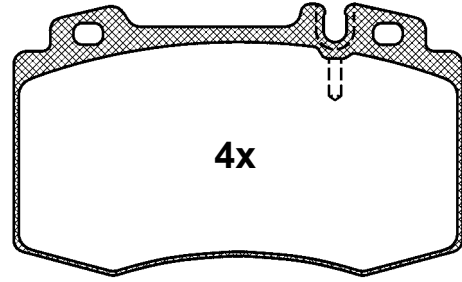

23271 17,7

119,6 x 71,5 x 17,7

## BA2182

 MERCEDES BENZ

 ATE

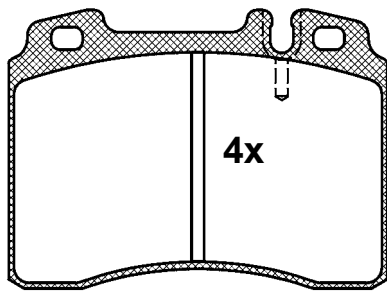

21153 17,5

99,8 x 73,6 x 17,5

## BA2185

 BMW, STEYR

 ATE

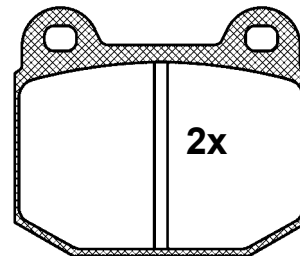

16,5

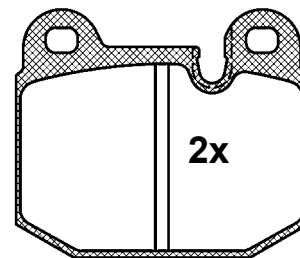

20588 16,5

77,0 x 65,3 x 16,5

# Abbildungen Scheibenbremsbeläge

Illustrations plaquettes de frein à disque / Illustrazioni pastiglie freno /

Figuras Calços do travão de disco / Rysunki okładzin hamulców tarczowych /

Zobrazení obložení kotoučových brzd

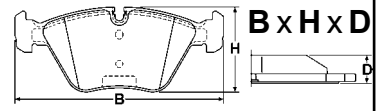

Maßstab - échelle - scala - escala - skala - měřítko 1:2

## BA2187



LAND ROVER

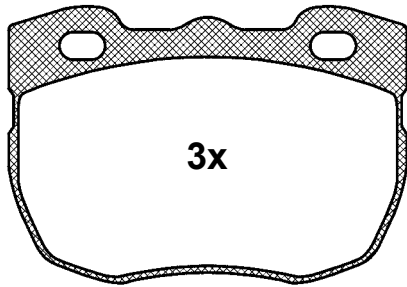

3x

21459 18,5

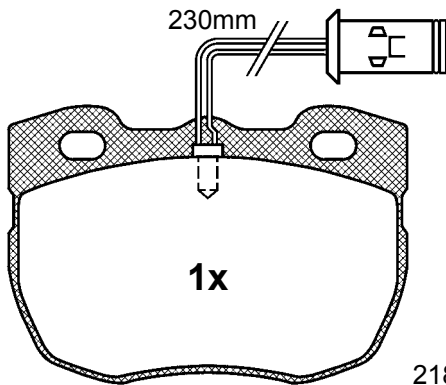

230mm

1x

21897 18,5

104,8 x 72,4 x 18,5

## BA2189



BMW

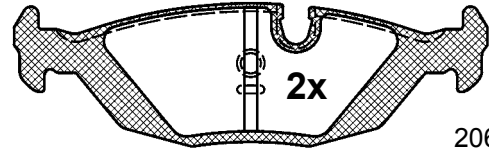

2x

20675 17,0

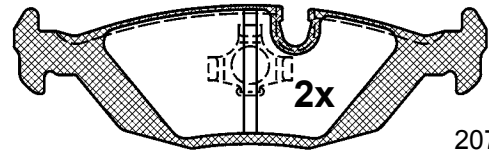

2x

20756 17,0

125,1 x 38,0 x 17,0

## BA2188



BMW

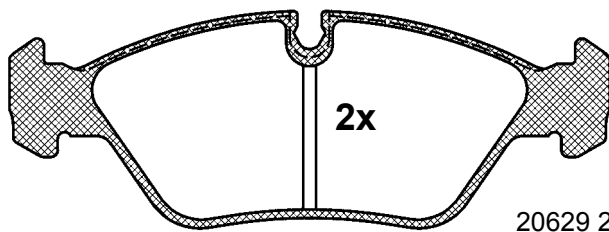

2x

20629 20,0

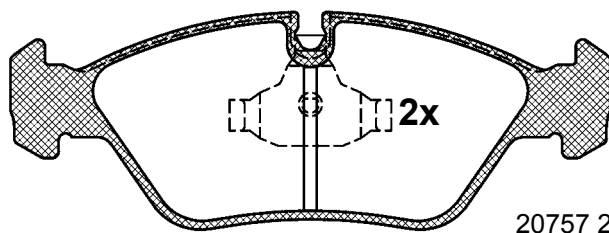

2x

20757 20,0

158,4 x 57,2 x 20,0

## BA2190



BMW, MG, ROVER

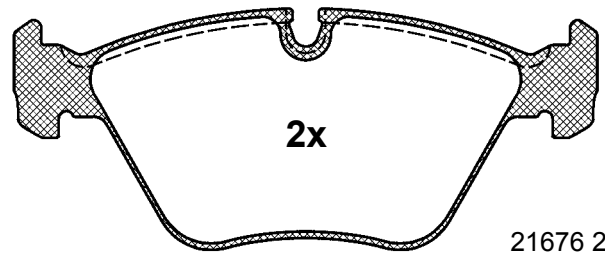

2x

21676 20,3

156,4 x 63,6 x 20,3

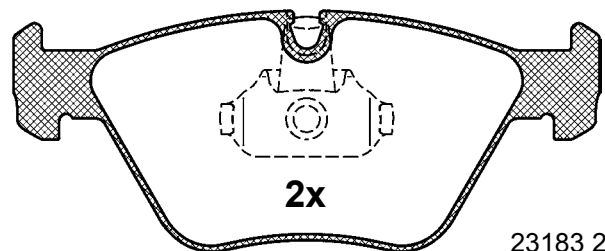

2x

23183 20,3

155,1 x 63,6 x 20,3

# Abbildungen Scheibenbremsbeläge

Illustrations plaquettes de frein à disque / Illustrazioni pastiglie freno /  
 Figuras Calços do travão de disco / Rysunki okładzin hamulców tarczowych /  
 Zobrazení obložení kotoučových brzd

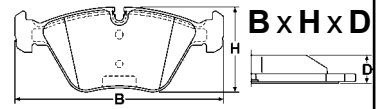

Maßstab - échelle - scala - escala - skala - měřítko 1:2

## BA2191



MERCEDES BENZ

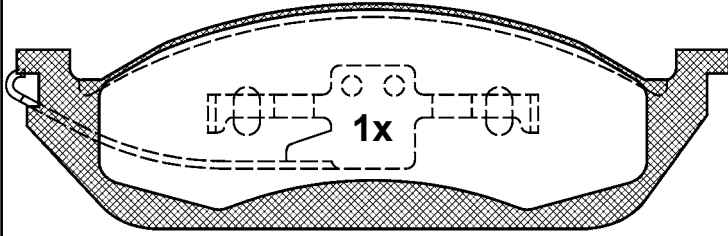

187,9 x 59,1 x 16,3

23193 16,3

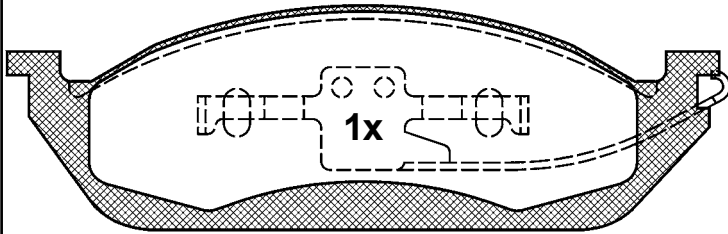

187,9 x 59,1 x 16,3

23194 16,3

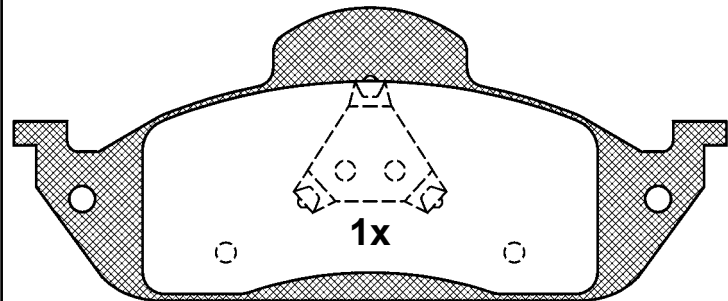

187,9 x 77,3 x 17,3

23195 17,3

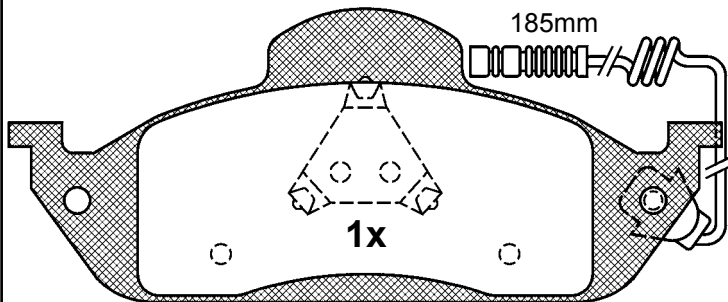

187,9 x 77,3 x 17,3

23196 17,3

## BA2192



MERCEDES BENZ

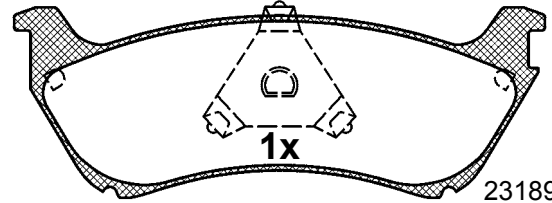

23189 16,7

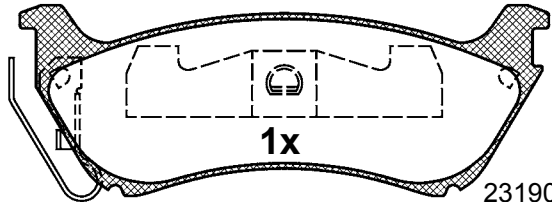

23190 16,7

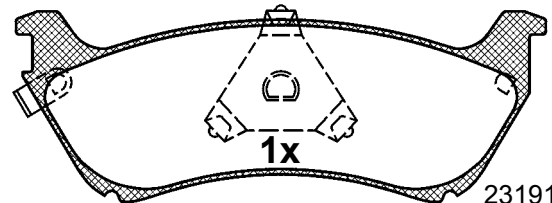

23191 16,7

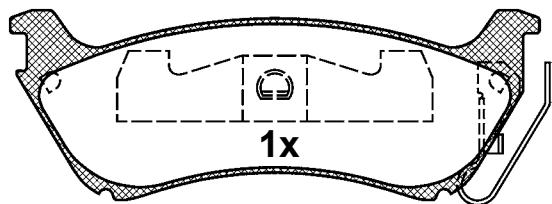

23192 16,7

140,1 x 50,0 x 16,7

# Abbildungen Scheibenbremsbeläge

Illustrations plaquettes de frein à disque / Illustrazioni pastiglie freno /  
Figuras Calços do travão de disco / Rysunki okładzin hamulców tarczowych /  
Zobrazení obložení kotoučových brzd

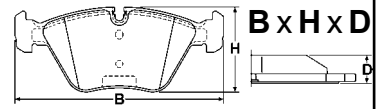

Maßstab - échelle - scala - escala - skala - měřítko 1:2

## BA2193

BMW

ATE

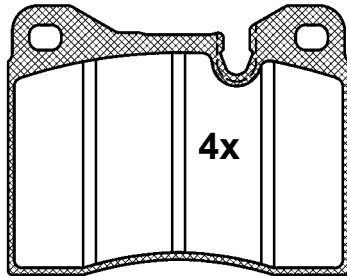

20437 19,0

89,7 x 70,6 x 19,0

## BA2195

AUDI, SEAT, SKODA,  
VOLKSWAGEN

ATE

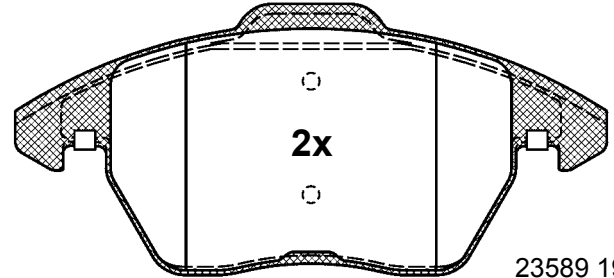

23589 19,6

156,3 x 71,6 x 19,6

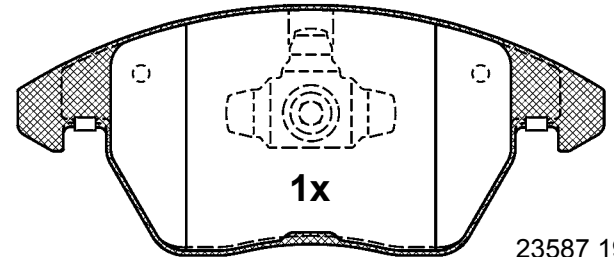

23587 19,6

155,0 x 66,1 x 19,6

## BA2194

KIA, OPEL, VAUXHALL

LUC

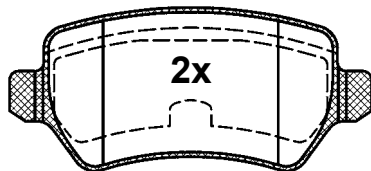

23417 15,2

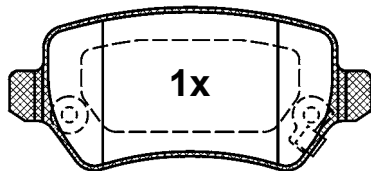

23654 15,2

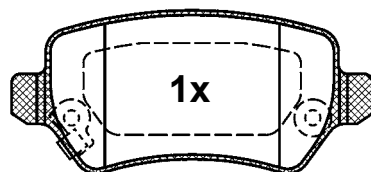

23655 15,2

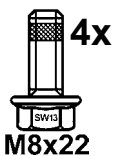

95,4 x 42,6 x 15,2

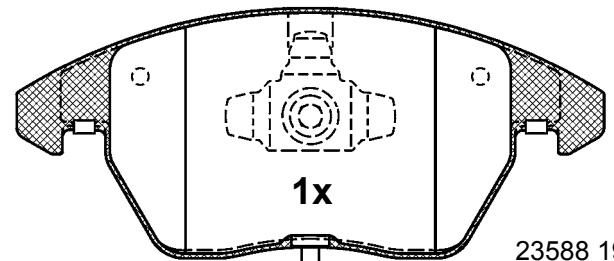

23588 19,6

145mm

155,0 x 66,1 x 19,6

## BA2196

AUDI, SEAT, SKODA,  
VOLKSWAGEN

LUC

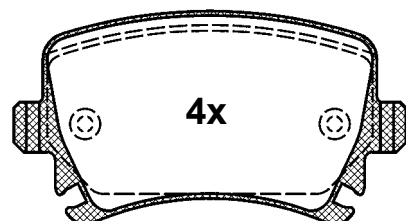

23914 16,3



105,2 x 56,1 x 16,3

# Abbildungen Scheibenbremsbeläge

Illustrations plaquettes de frein à disque / Illustrazioni pastiglie freno /  
Figuras Calços do travão de disco / Rysunki okładzin hamulców tarczowych /  
Zobrazení obložení kotoučových brzd

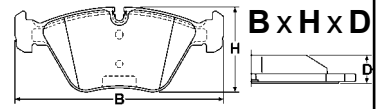

Maßstab - échelle - scala - escala - skala - měřítko 1:2

## BA2197



OPEL, VAUXHALL



BOS

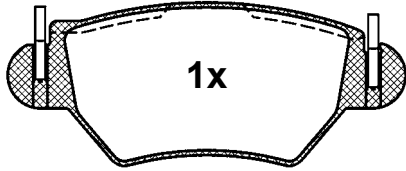

1x

23258 16,9

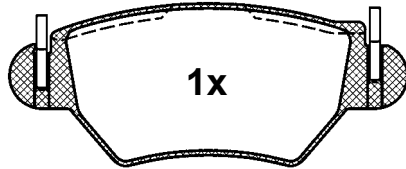

1x

23259 16,9

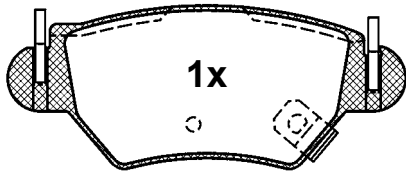

1x

23262 16,9

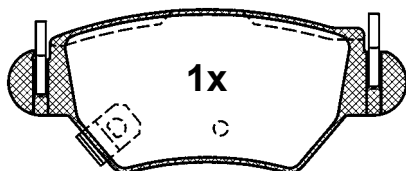

1x

23263 16,9



M8x20

104,7 x 42,7 x 16,9

## BA2199



FORD, MAZDA



ATE

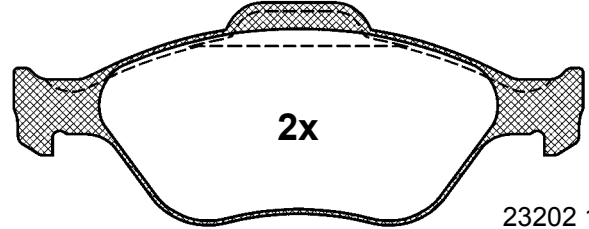

2x

23202 18,8

151,3 x 58,4 x 18,8

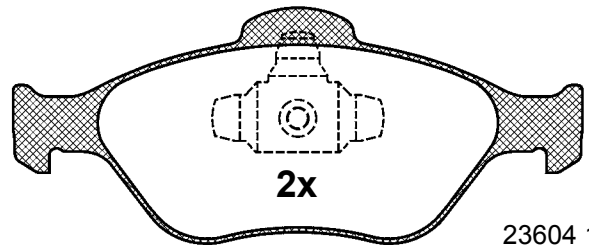

2x

23604 18,8

150,1 x 61,2 x 18,8

## BA2198



AUDI, SEAT, VOLKSWAGEN



LUC

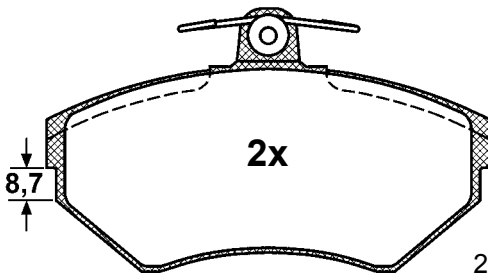

2x

21945 19,6

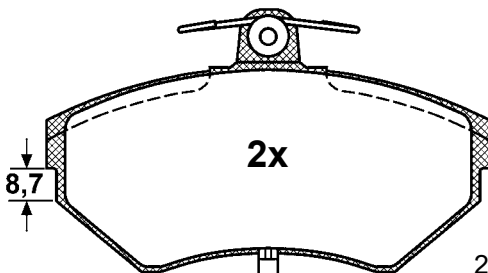

2x

23393 19,6



M8x21

118,8 x 69,6 x 19,6

## BA2200



FORD, SEAT, VOLKSWAGEN



LUC

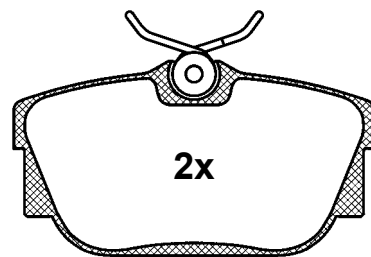

2x

23224 16,5

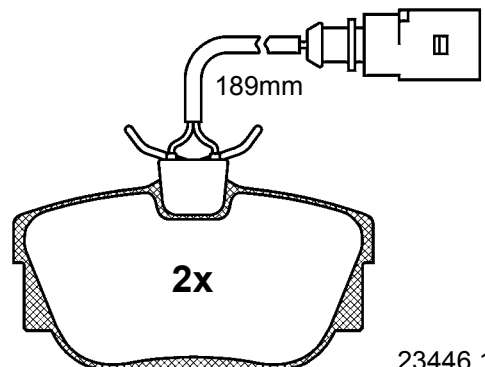

2x

23446 16,5



M8x21

94,9 x 51,2 x 16,5

# Abbildungen Scheibenbremsbeläge

Illustrations plaquettes de frein à disque / Illustrazioni pastiglie freno /

Figuras Calços do travão de disco / Rysunki okładzin hamulców tarczowych /

Zobrazení obložení kotoučových brzd

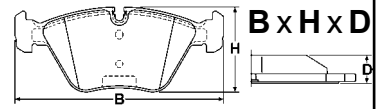

Maßstab - échelle - scala - escala - skala - měřítko 1:2

## BA2201



VOLKSWAGEN



ATE

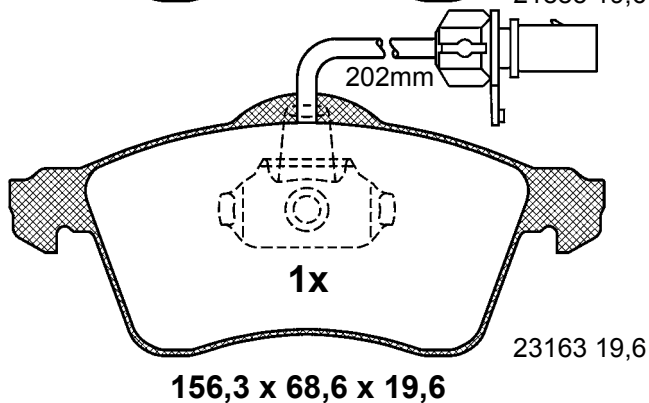
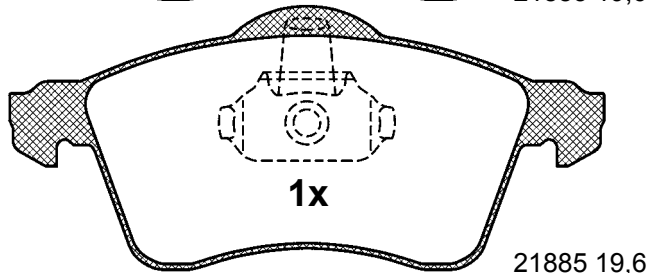
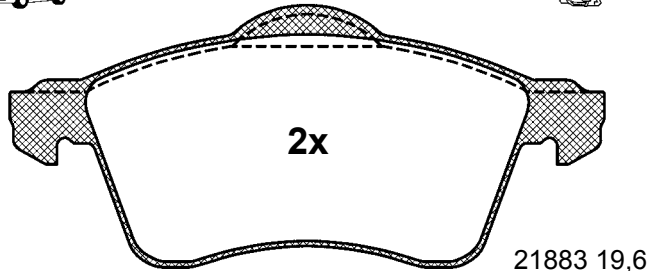

## BA2203



FORD, MAZDA



ATE

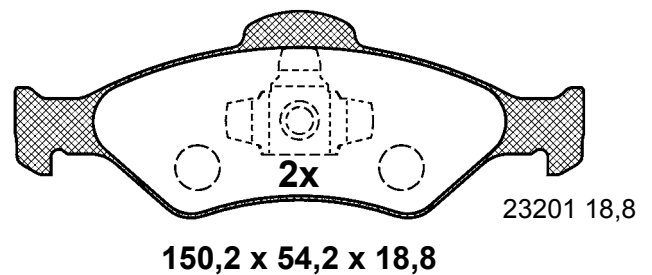
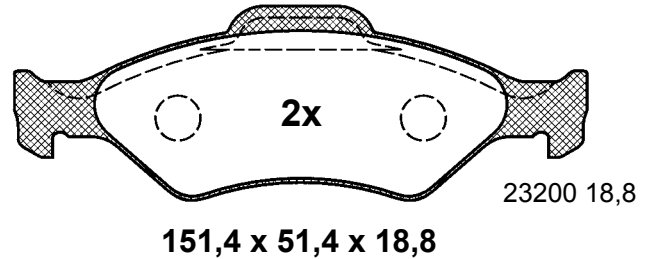

## BA2204



MERCEDES BENZ



BRE

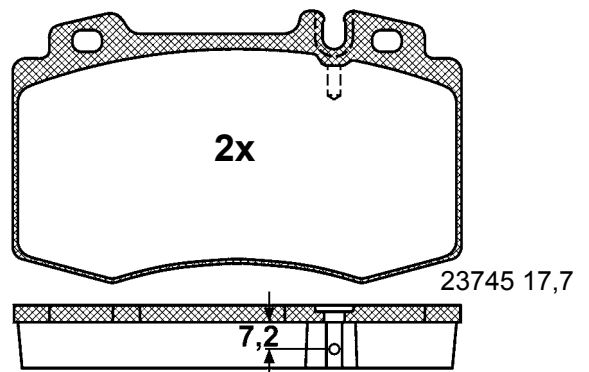
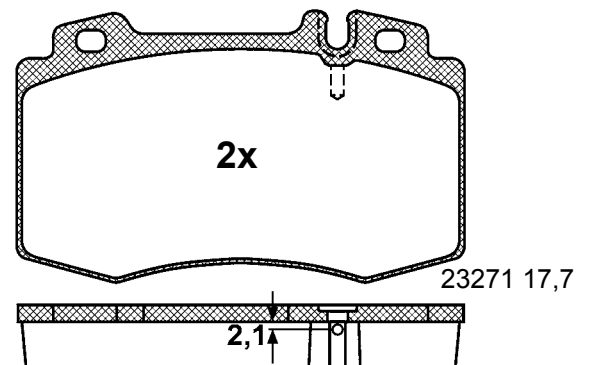

## BA2202



VOLKSWAGEN



LUC

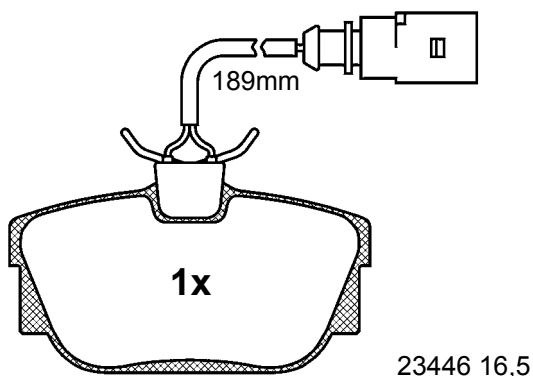
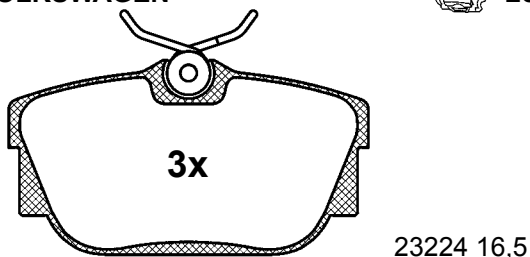

94,9 x 51,2 x 16,5

119,6 x 71,5 x 17,7

# Abbildungen Scheibenbremsbeläge

Illustrations plaquettes de frein à disque / Illustrazioni pastiglie freno /  
Figuras Calços do travão de disco / Rysunki okładzin hamulców tarczowych /  
Zobrazení obložení kotoučových brzd

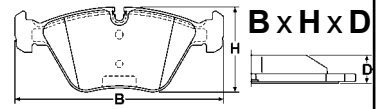

Maßstab - échelle - scala - escala - skala - měřítko 1:2

## BA2205



AUDI, SEAT, SKODA,  
VOLKSWAGEN

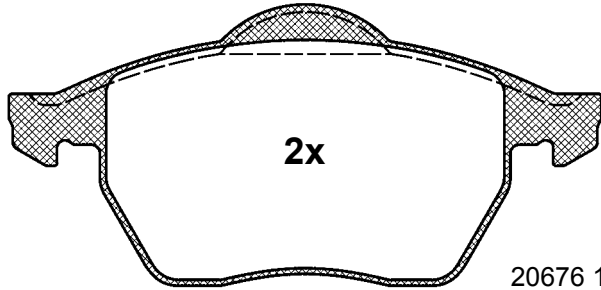

2x

20676 19,5

156,3 x 74,1 x 19,5

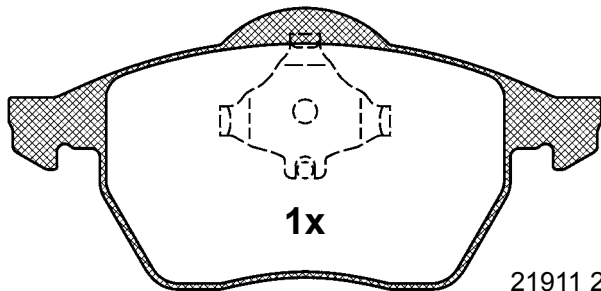

1x

21911 20,6

156,3 x 74,1 x 20,6

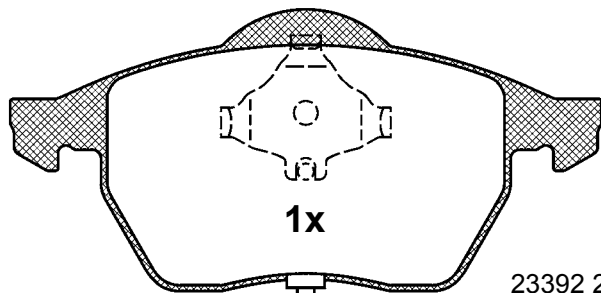

1x

23392 20,6

155mm

156,3 x 74,1 x 20,6

## BA2207



OPEL, SAAB, VAUXHALL

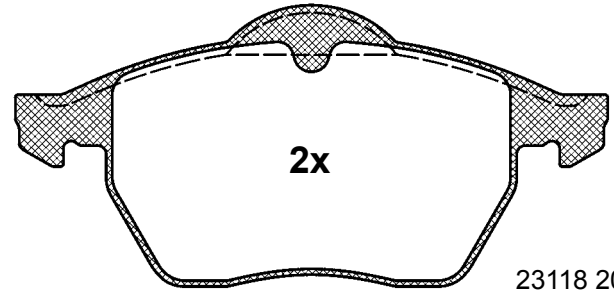

2x

23118 20,3

156,3 x 74,1 x 20,3

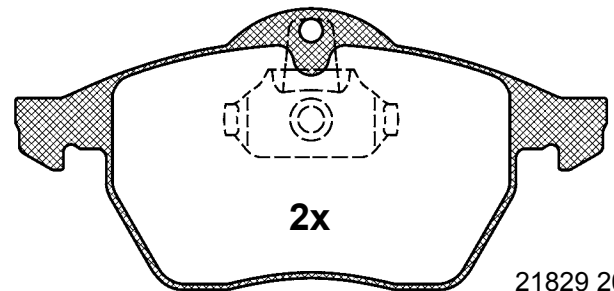

2x

21829 20,3

155,1 x 74,1 x 20,3

## BA2208



FORD

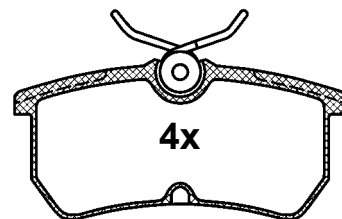

4x

23353 15,0

87,1 x 42,4 x 15,0



4x

M8x21

## BA2206



MERCEDES BENZ

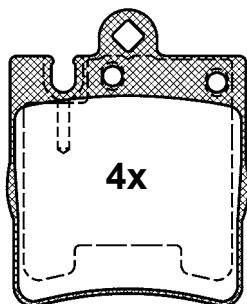

4x

21899 15,1

63,7 x 78,1 x 15,1

# Abbildungen Scheibenbremsbeläge

Illustrations plaquettes de frein à disque / Illustrazioni pastiglie freno /

Figuras Calços do travão de disco / Rysunki okładzin hamulców tarczowych /

Zobrazení obložení kotoučových brzd

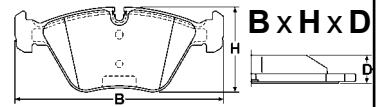

Maßstab - échelle - scala - escala - skala - měřítko 1:2

## BA2209

FORD

ATE

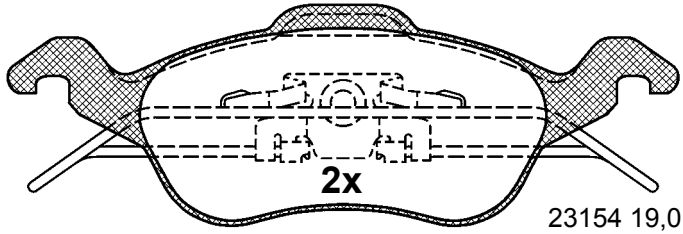

23154 19,0

177,9 x 58,4 x 19,0

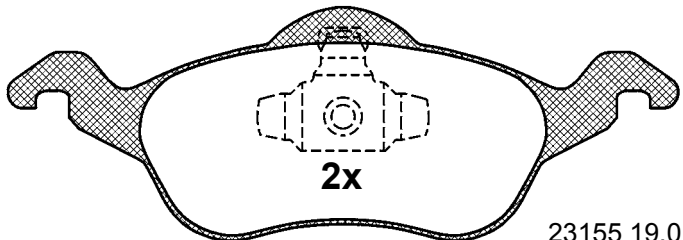

23155 19,0

177,9 x 61,0 x 19,0

## BA2211

OPEL, VAUXHALL

ATE

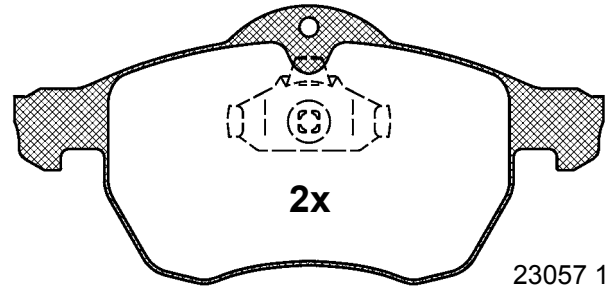

23057 19,6

155,2 x 71,7 x 19,6

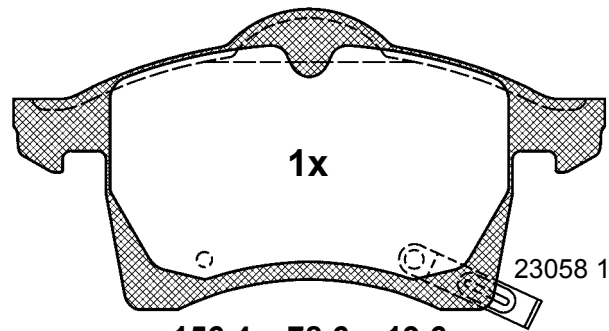

23058 19,6

156,4 x 78,6 x 19,6

## BA2210

OPEL, VAUXHALL

LUC

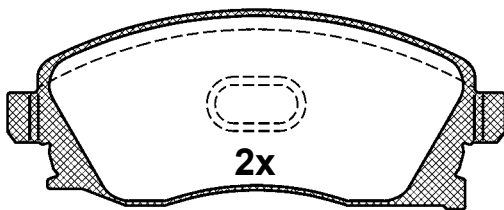

23225 17,0

131,5 x 52,5 x 17,0

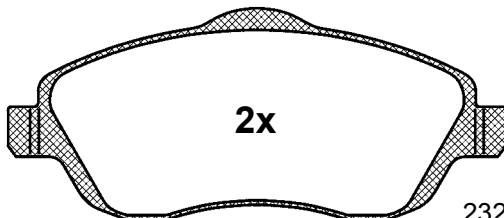

23226 17,0

131,6 x 55,8 x 17,0

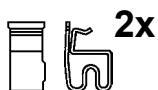
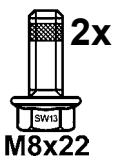

## BA2212

RENAULT

LUC

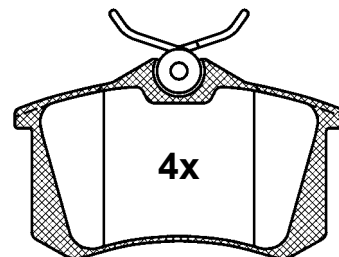

23554 16,4



87,1 x 52,9 x 16,4



# Abbildungen Scheibenbremsbeläge

Illustrations plaquettes de frein à disque / Illustrazioni pastiglie freno /  
Figuras Calços do travão de disco / Rysunki okładzin hamulców tarczowych /  
Zobrazení obložení kotoučových brzd

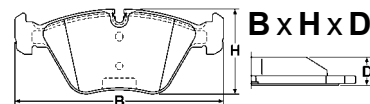

Maßstab - échelle - scala - escala - skala - měřítko 1:2

## BA2213



MERCEDES BENZ

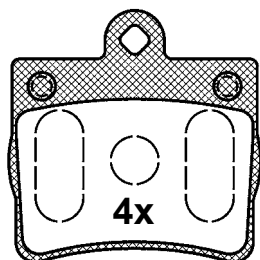

21900 15,8

63,7 x 63,3 x 15,8

## BA2216



MERCEDES BENZ, VOLKSWAGEN

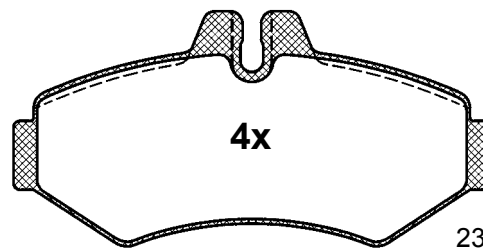

23021 18,9

125,9 x 62,0 x 18,9

## BA2214



CITROEN, PEUGEOT

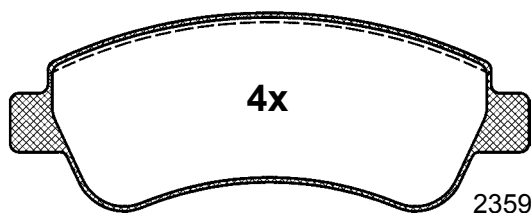

23599 19,0

136,9 x 51,6 x 19,0

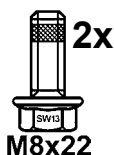

SMART

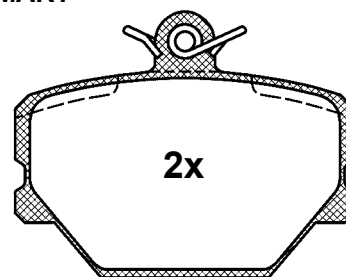

21999 15,5

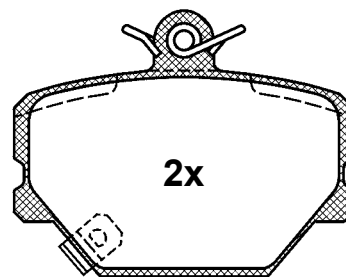

23001 15,5

90,1 x 70,1 x 15,5

## BA2215



MERCEDES BENZ, VOLKSWAGEN

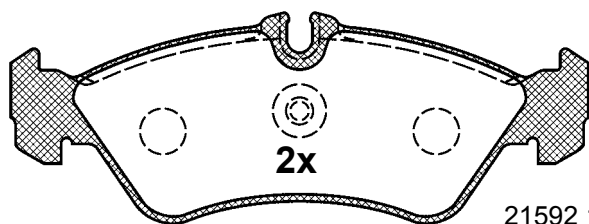

21592 18,5

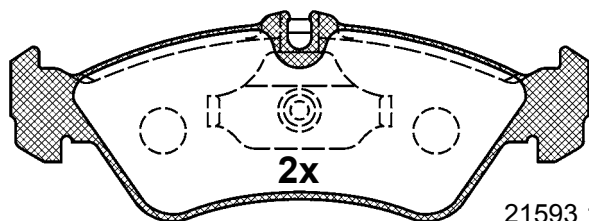

21593 18,5

156,4 x 55,0 x 18,5

## BA2218



MERCEDES BENZ

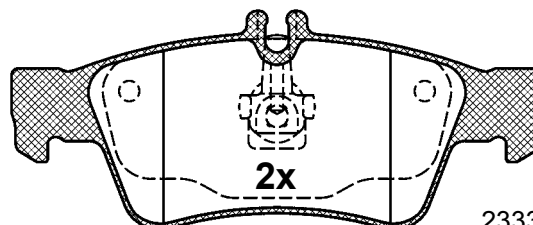

23334 16,1

140,2 x 57,3 x 16,1

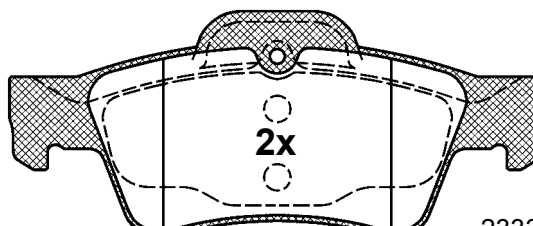

23335 16,1

141,3 x 59,6 x 16,1

# Abbildungen Scheibenbremsbeläge

Illustrations plaquettes de frein à disque / Illustrazioni pastiglie freno /  
Figuras Calços do travão de disco / Rysunki okładzin hamulców tarczowych /  
Zobrazení obložení kotoučových brzd

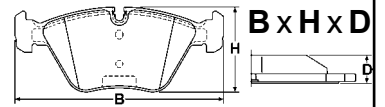

Maßstab - échelle - scala - escala - skala - měřítko 1:2

## BA2219



RENAULT



LUC

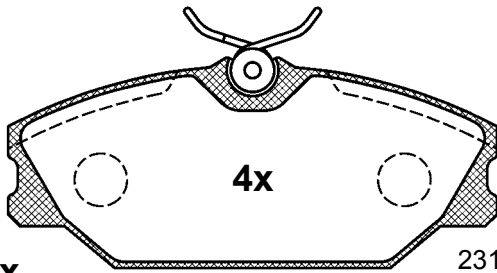

4x

23172 18,3



4x  
M8x21

128,7 x 55,4 x 18,3

## BA2224



FORD, JAGUAR



BOS

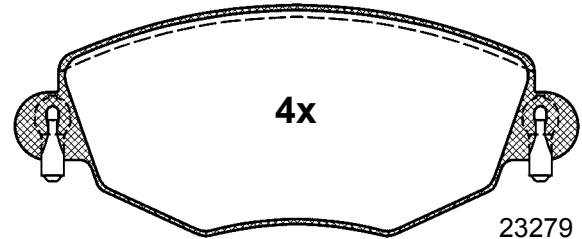

4x

23279 18,5



4x  
M8x22

148,9 x 60,6 x 18,5

## BA2220



MERCEDES BENZ



LUC



4x

23138 14,6



2x  
M8x22

95,5 x 41,3 x 14,6

## BA2225



FORD, JAGUAR, RENAULT



BOS

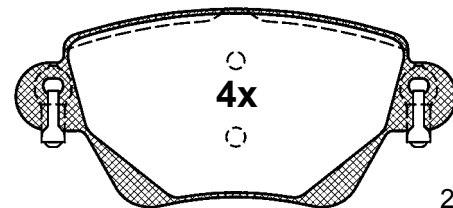

4x

23557 17,2

115,7 x 51,9 x 17,2



4x  
M8x22

## BA2221



MERCEDES BENZ



BOS

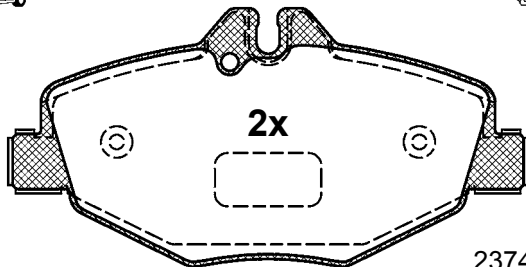

2x

23743 20,1

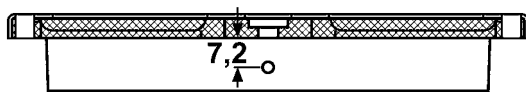

7,2

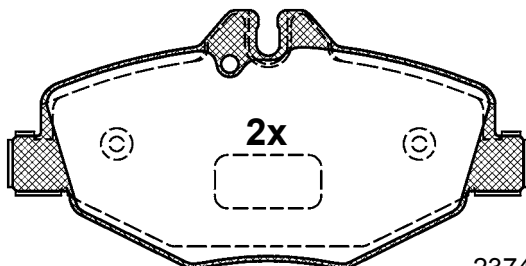

2x

23743 20,1



2x  
M8x22

136,7 x 68,0 x 20,1

## BA2226



MITSUBISHI, SMART, VOLVO



LUC

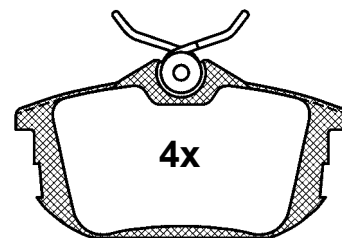

4x

21861 15,3

87,1 x 47,1 x 15,3



4x  
M8x21

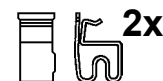

2x

# Abbildungen Scheibenbremsbeläge

Illustrations plaquettes de frein à disque / Illustrazioni pastiglie freno /  
Figuras Calços do travão de disco / Rysunki okładzin hamulców tarczowych /  
Zobrazení obložení kotoučových brzd

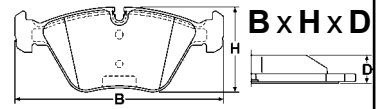

Maßstab - échelle - scala - escala - skala - měřítko 1:2

## BA2227



NISSAN

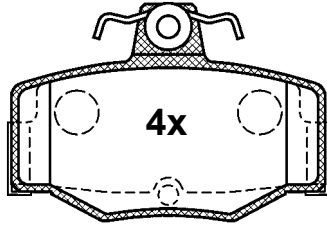

21545 14,9

82,2 x 57,0 x 14,9

## BA2230



RENAULT

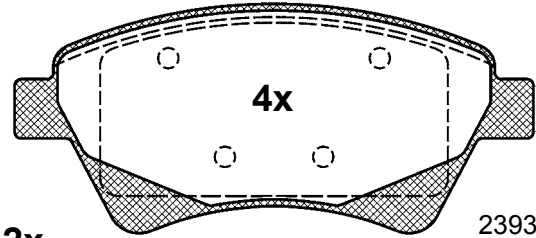

23930 17,5

136,7 x 59,5 x 17,5



## BA2228



FORD, SEAT, VOLKSWAGEN

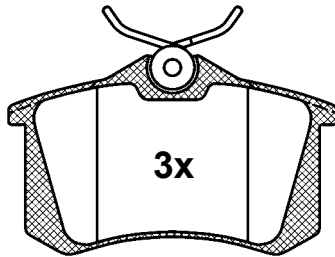

20961 17,2

87,1 x 52,9 x 17,2

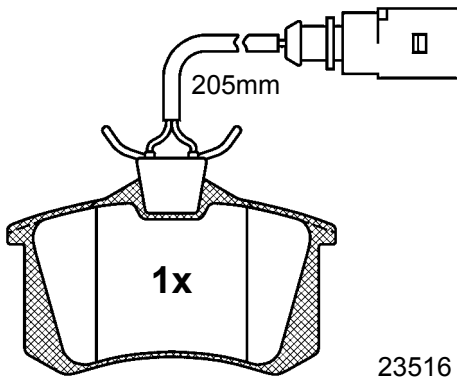

23516 17,2



## BA2231



FORD, SEAT, VOLKSWAGEN

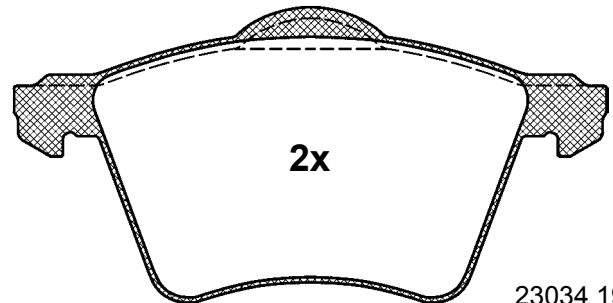

23034 19,6

156,3 x 78,6 x 19,6

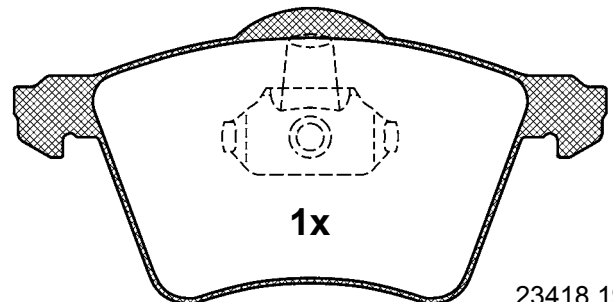

23418 19,6

156,4 x 78,6 x 19,6

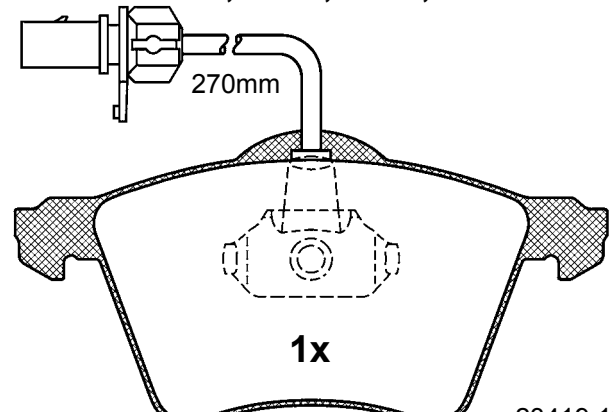

23419 19,6

156,4 x 78,6 x 19,6

## BA2229



CITROEN, PEUGEOT

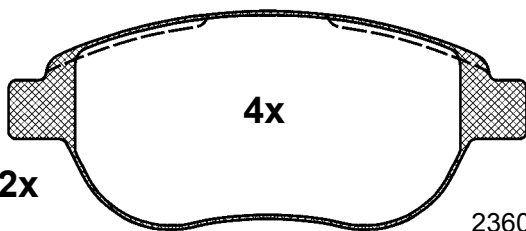

23600 19,0

136,8 x 57,2 x 19,0



# Abbildungen Scheibenbremsbeläge

Illustrations plaquettes de frein à disque / Illustrazioni pastiglie freno /

Figuras Calços do travão de disco / Rysunki okładzin hamulców tarczowych /

Zobrazení obložení kotoučových brzd

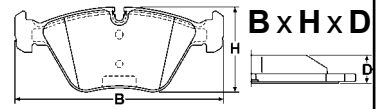

Maßstab - échelle - scala - escala - skala - měřítko 1:2

## BA2232



NISSAN

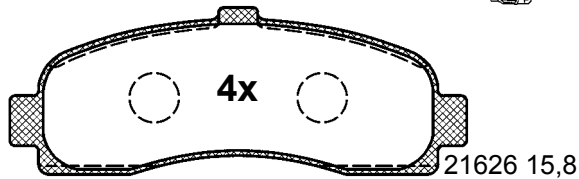

120,8 x 45,0 x 15,8

21626 15,8

## BA2235



CITROEN, FORD, JAGUAR, OPEL,  
RENAULT, SAAB, VAUXHALL

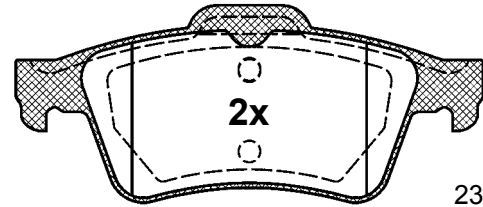

23482 16,4

## BA2233



MERCEDES BENZ, VOLKSWAGEN

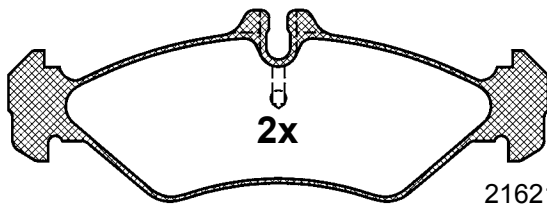

21621 17,0

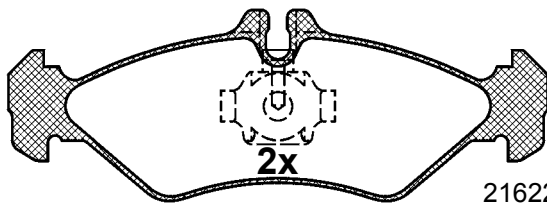

21622 17,0

141,4 x 50,1 x 17,0

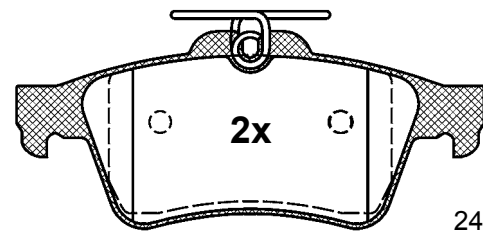

24137 16,4

123,1 x 51,9 x 16,4



## BA2234



FORD, MAZDA, VOLVO

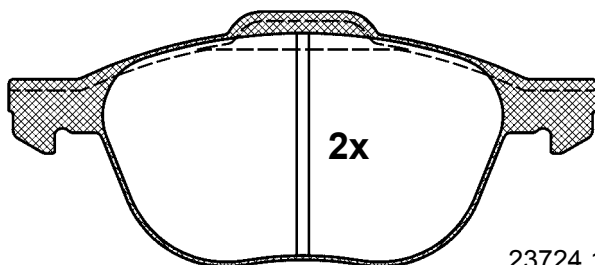

23724 18,4

156,4 x 67,1 x 18,4

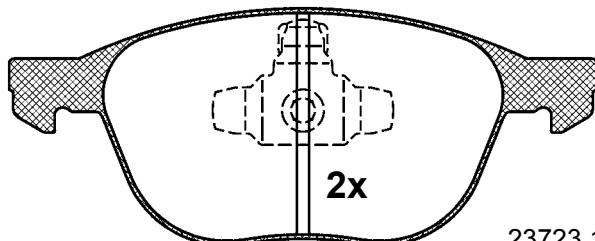

23723 18,4

155,2 x 62,5 x 18,4

## BA2236



FIAT, OPEL, SAAB, VAUXHALL

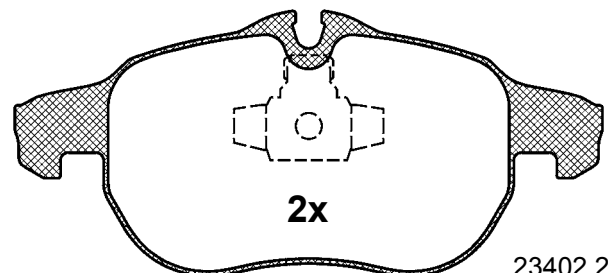

23402 20,4

155,1 x 69,8 x 20,4

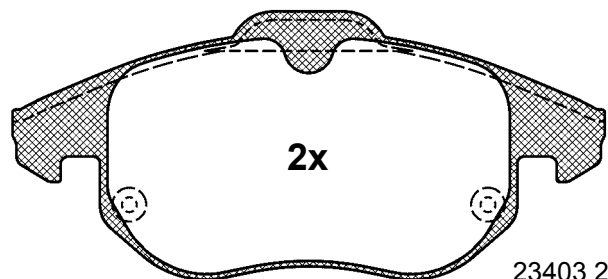

23403 20,4

156,4 x 70,8 x 20,4

# Abbildungen Scheibenbremsbeläge

Illustrations plaquettes de frein à disque / Illustrazioni pastiglie freno /  
Figuras Calços do travão de disco / Rysunki okładzin hamulców tarczowych /  
Zobrazení obložení kotoučových brzd

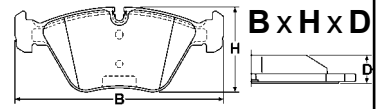

Maßstab - échelle - scala - escala - skala - měřítko 1:2

## BA2237



MITSUBISHI, SMART, VOLVO

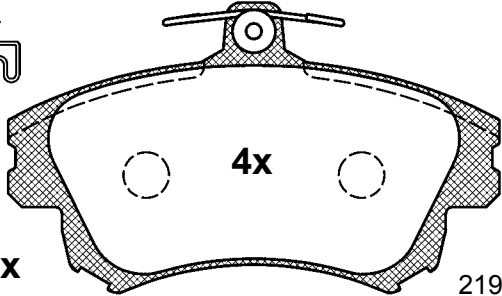
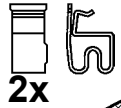

21983 17,3

130,0 x 77,1 x 17,3

## BA2240



BMW

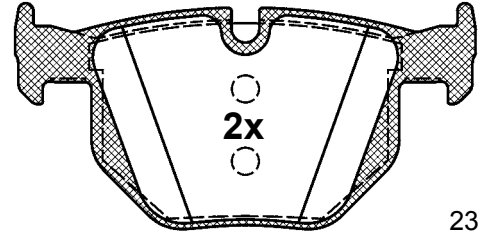

23732 17,3

121,9 x 59,2 x 17,3

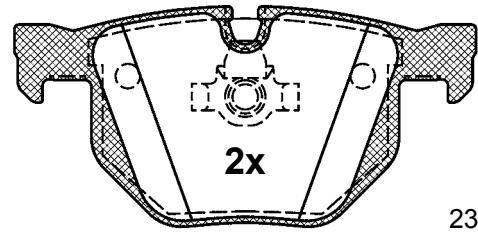

23737 17,3

121,9 x 58,2 x 17,3

## BA2238



FORD, NISSAN, RENAULT

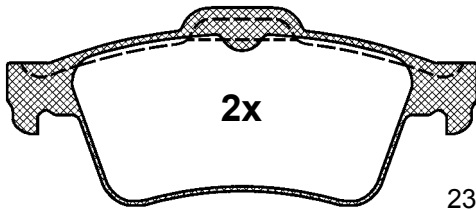

23482 16,4

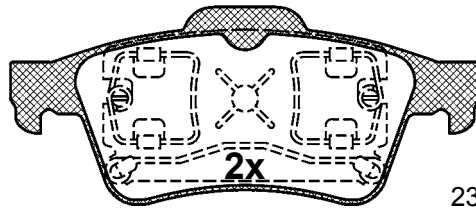

23483 16,4

123,0 x 51,9 x 16,4

## BA2241



CITROEN, FIAT, PEUGEOT

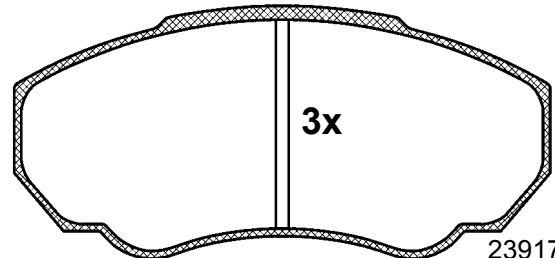

23917 19,0

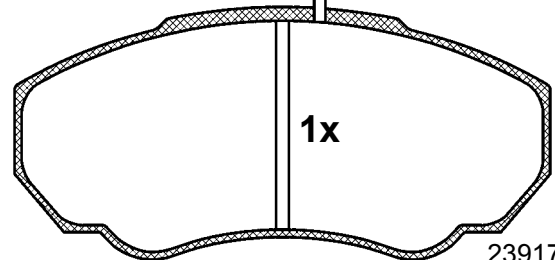
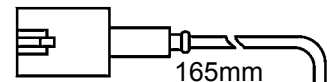

23917 19,0

140,6 x 65,9 x 19,0

## BA2239



MERCEDES BENZ, VOLKSWAGEN

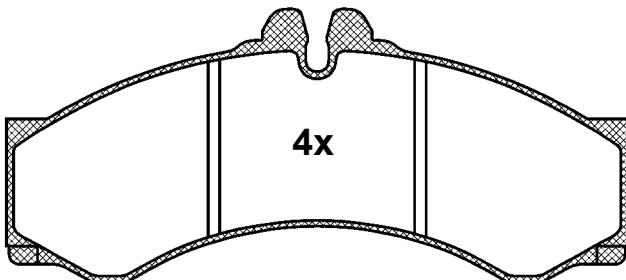

29076 20,0

164,6 x 72,9 x 20,0

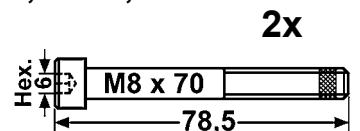
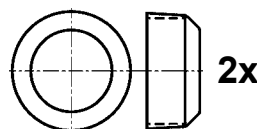

# Abbildungen Scheibenbremsbeläge

Illustrations plaquettes de frein à disque / Illustrazioni pastiglie freno /

Figuras Calços do travão de disco / Rysunki okładzin hamulców tarczowych /

Zobrazení obložení kotoučových brzd

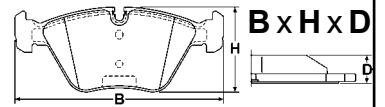

Maßstab - échelle - scala - escala - skala - měřítko 1:2

## BA2242



VOLKSWAGEN



ATE

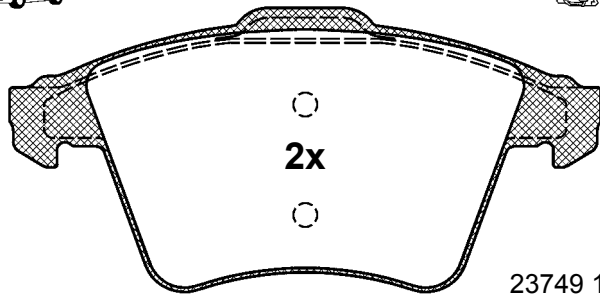

2x

23749 17,0

156,3 x 75,0 x 17,0

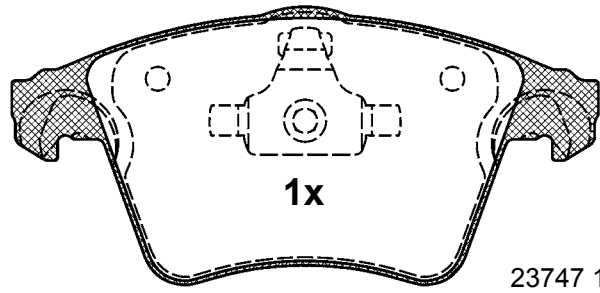

1x

23747 17,5

155,1 x 73,3 x 17,5

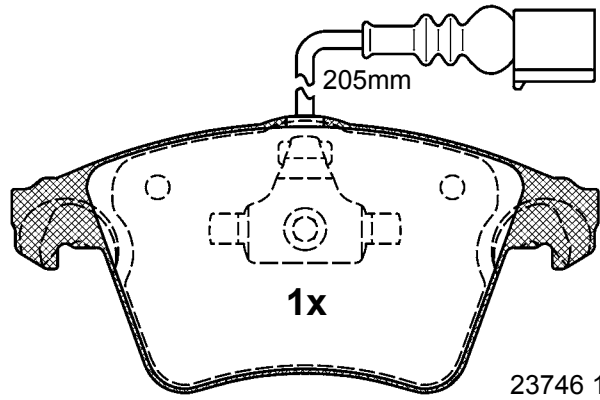

205mm

1x

23746 17,5

155,1 x 73,3 x 17,5

## BA2244



VOLVO



ATE

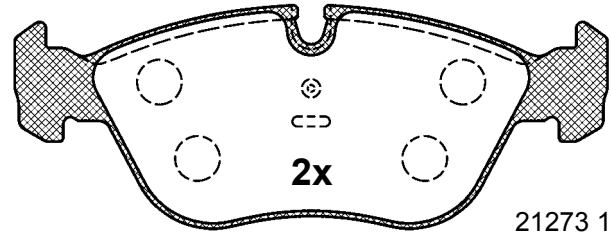

2x

21273 19,5

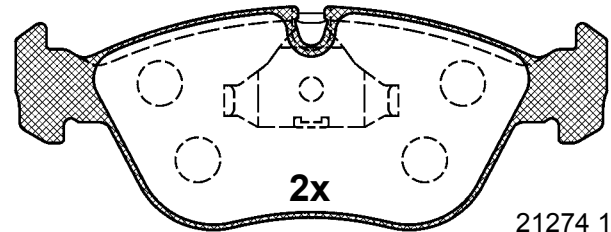

2x

21274 19,5

156,4 x 58,5 x 19,5

## BA2245



BMW



ATE

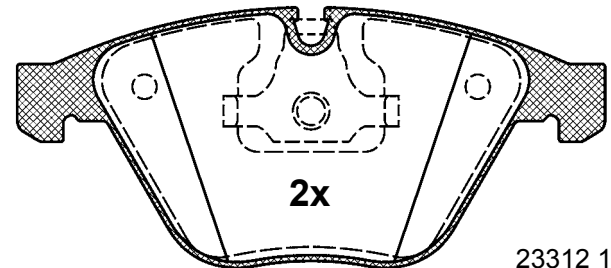

2x

23312 19,6

155,1 x 68,4 x 19,6

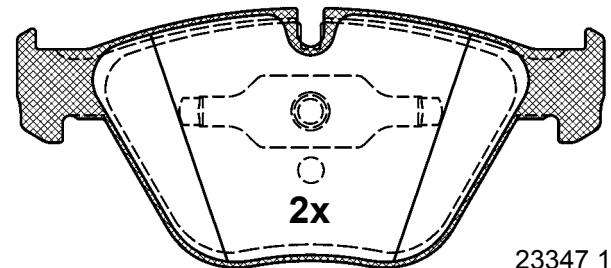

2x

23347 19,6

155,2 x 68,4 x 19,6

## BA2243



VOLKSWAGEN



LUC

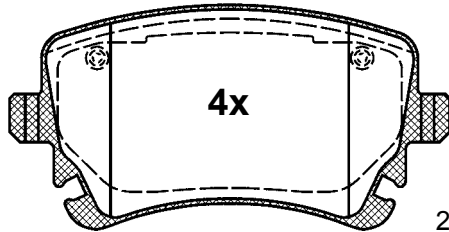

4x

20437 17,4

116,1 x 58,9 x 17,4



4x

M8x22

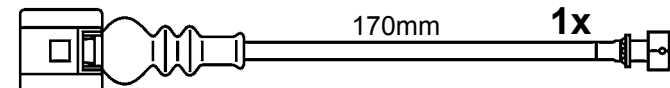

170mm

1x

# Abbildungen Scheibenbremsbeläge

Illustrations plaquettes de frein à disque / Illustrazioni pastiglie freno /  
Figuras Calços do travão de disco / Rysunki okładzin hamulców tarczowych /  
Zobrazení obložení kotoučových brzd

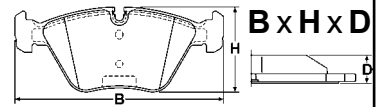

Maßstab - échelle - scala - escala - skala - měřítko 1:2

## BA2246

AUDI

ATE

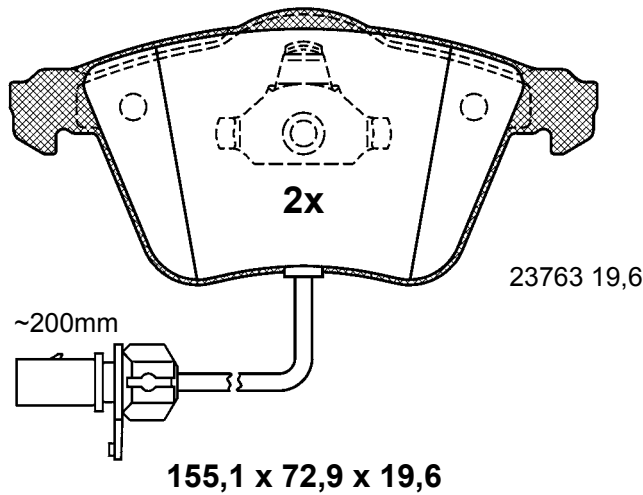
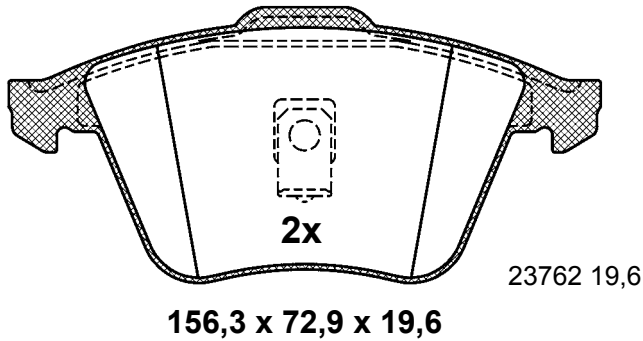

## BA2249

CITROEN, MITSUBISHI, PEUGEOT AKE

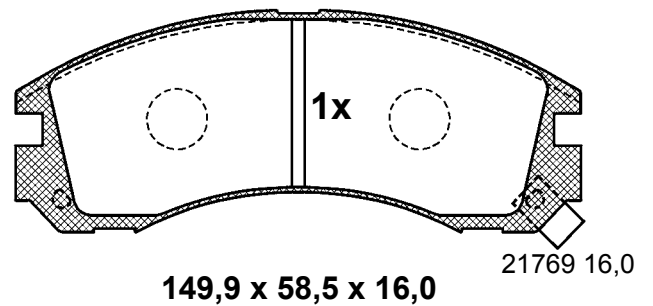
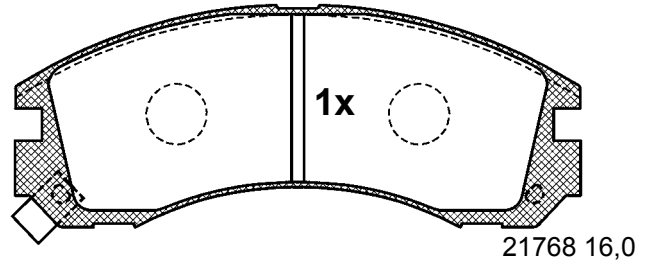
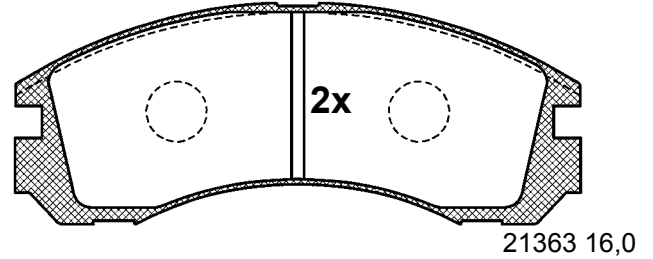

## BA2247

NISSAN, OPEL, RENAULT, VAUXHALL

LUC

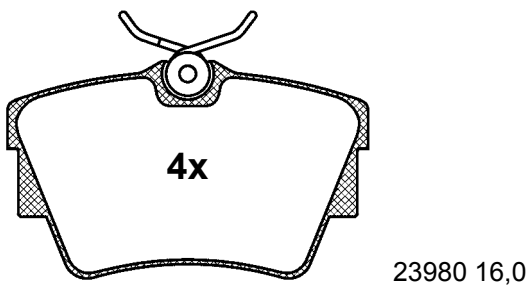

94,9 x 57,4 x 16,0

## BA2250

MERCEDES BENZ

ATE

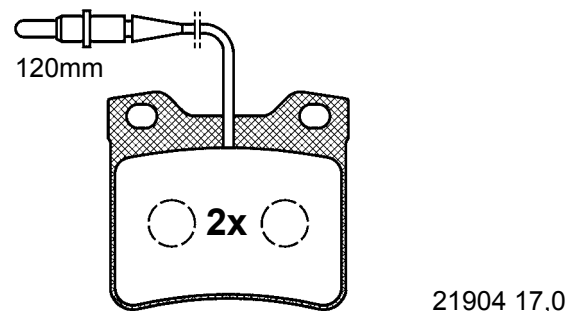
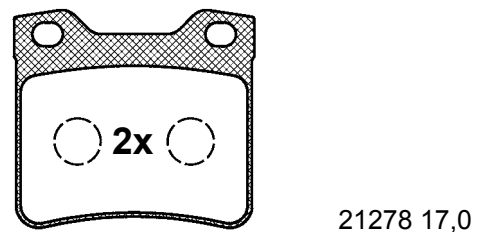

63,6 x 57,1 x 17,0

# Abbildungen Scheibenbremsbeläge

Illustrations plaquettes de frein à disque / Illustrazioni pastiglie freno /

Figuras Calços do travão de disco / Rysunki okładzin hamulców tarczowych /

Zobrazení obložení kotoučových brzd

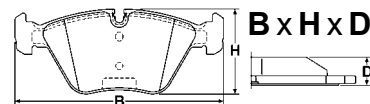

Maßstab - échelle - scala - escala - skala - měřítko 1:2

## BA2251



NISSAN, OPEL, RENAULT,  
VAUXHALL



BOS

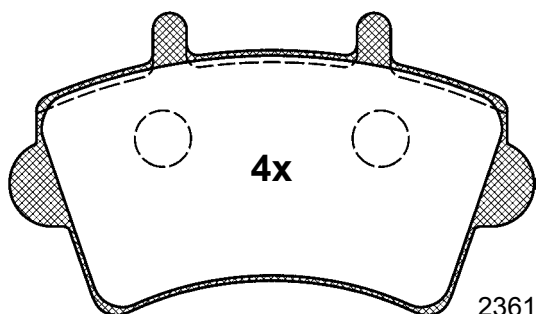

23613 17,8

138,8 x 79,9 x 17,8

## BA2253



VOLVO



ATE

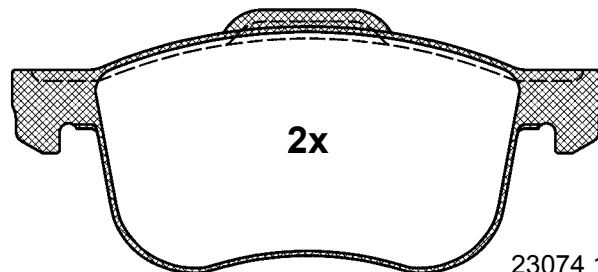

23074 18,8

156,4 x 68,9 x 18,8

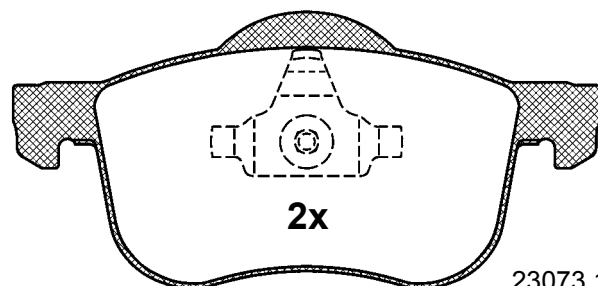

23073 18,8

155,1 x 72,4 x 18,8

## BA2252



BMW



ATE

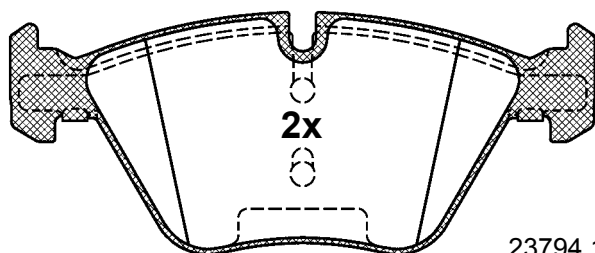

23794 19,6

154,6 x 63,4 x 19,6

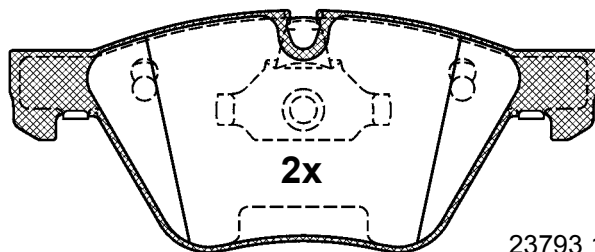

23793 19,6

155,1 x 63,4 x 19,6

## BA2254



NISSAN, OPEL, RENAULT,  
VAUXHALL



LUC

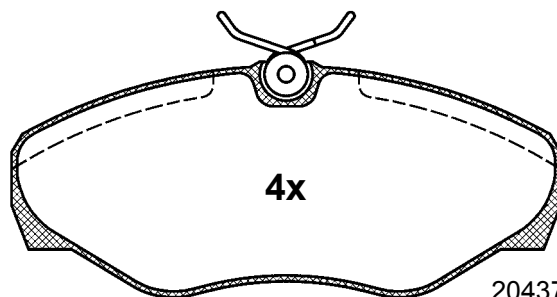

20437 18,4

145,0 x 62,4 x 18,4

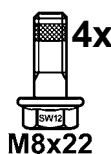



# Abbildungen Scheibenbremsbeläge

Illustrations plaquettes de frein à disque / Illustrazioni pastiglie freno /  
Figuras Calços do travão de disco / Rysunki okładzin hamulców tarczowych /  
Zobrazení obložení kotoučových brzd

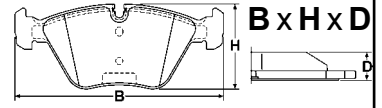

Maßstab - échelle - scala - escala - skala - měřítko 1:2

## BA2255



OPEL, VAUXHALL



ATE

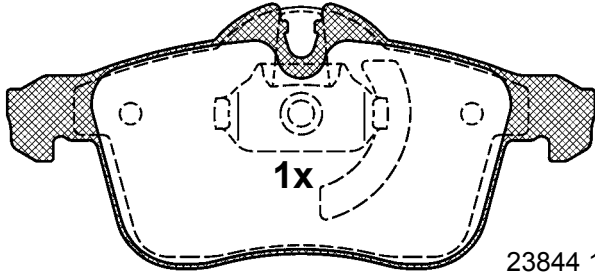

23844 19,7

155,1 x 70,0 x 19,7

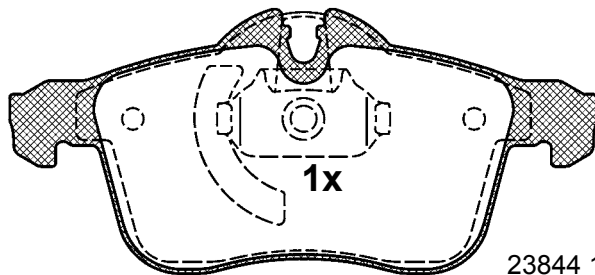

23844 19,7

155,1 x 70,0 x 19,7

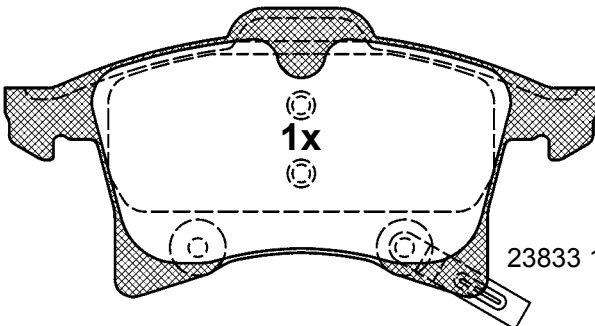

23833 19,7

156,3 x 76,1 x 19,7

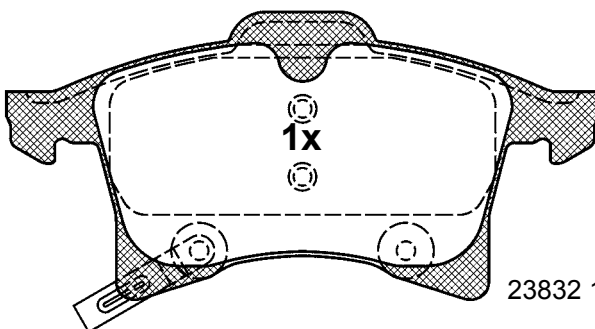

23832 19,7

156,3 x 76,1 x 19,7

## BA2256



OPEL, VAUXHALL



BOS

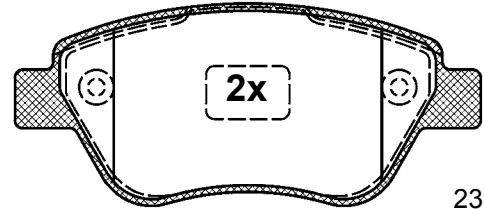

23982 17,8

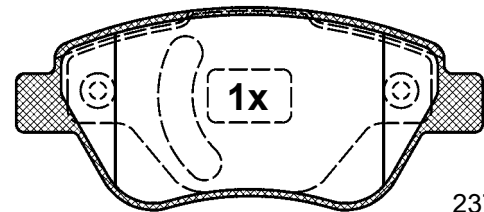

23707 17,8

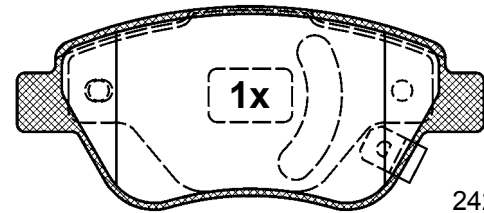

24288 17,8

122,9 x 53,2 x 17,8

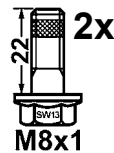

## BA2257



MAZDA



AKE

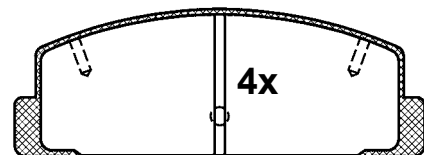

24045 13,7

107,7 x 39,4 x 13,7

# Abbildungen Scheibenbremsbeläge

Illustrations plaquettes de frein à disque / Illustrazioni pastiglie freno /

Figuras Calços do travão de disco / Rysunki okładzin hamulców tarczowych /

Zobrazení obložení kotoučových brzd

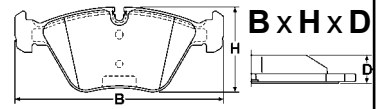

Maßstab - échelle - scala - escala - skala - měřítko 1:2

## BA2258



FORD, MAZDA, OPEL, SAAB,  
VAUXHALL, VOLVO

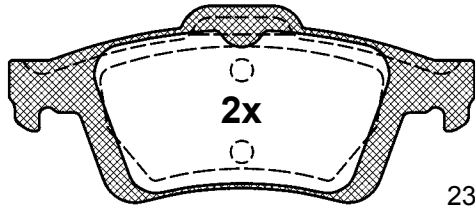

23482 16,4

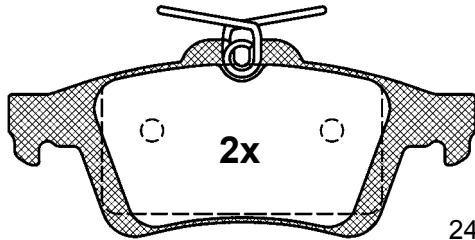

24137 16,4

123,1 x 51,9 x 16,4



## BA2260



OPEL, SUBARU, SUZUKI,  
VAUXHALL

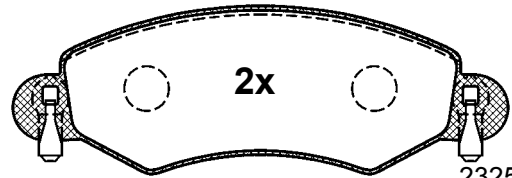

23253 15,9

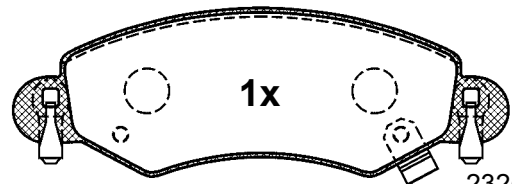

23254 15,9

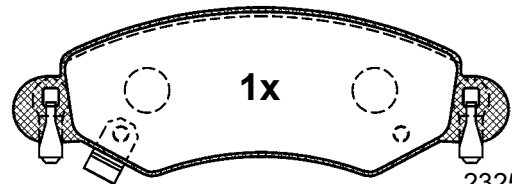

23257 15,9

## BA2259



AUDI, SEAT

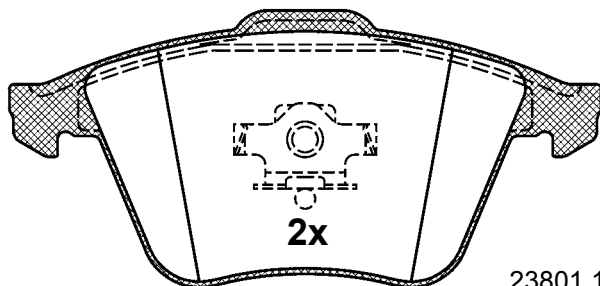

23801 19,6

156,3 x 72,9 x 19,6

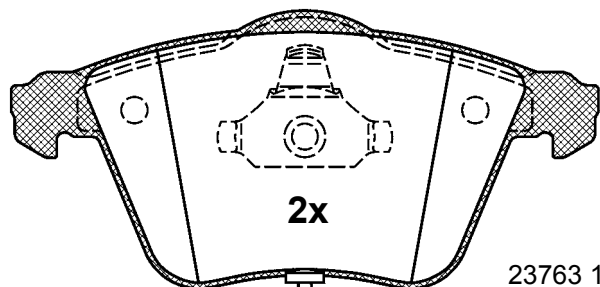

23763 19,6

155,1 x 72,9 x 19,6

250mm

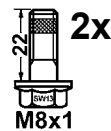

130,9 x 44,1 x 15,9

## BA2261



NISSAN, OPEL, RENAULT,  
VAUXHALL

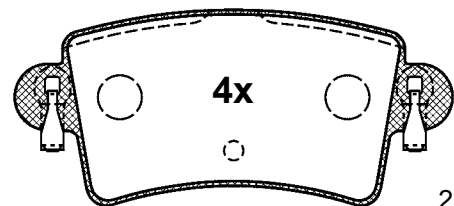

23669 16,8

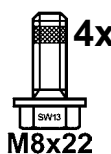

115,8 x 51,4 x 16,8

# Abbildungen Scheibenbremsbeläge

Illustrations plaquettes de frein à disque / Illustrazioni pastiglie freno /  
Figuras Calços do travão de disco / Rysunki okładzin hamulców tarczowych /  
Zobrazení obložení kotoučových brzd

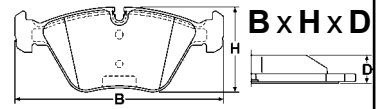

Maßstab - échelle - scala - escala - skala - měřítko 1:2

## BA2262

FORD

BOS

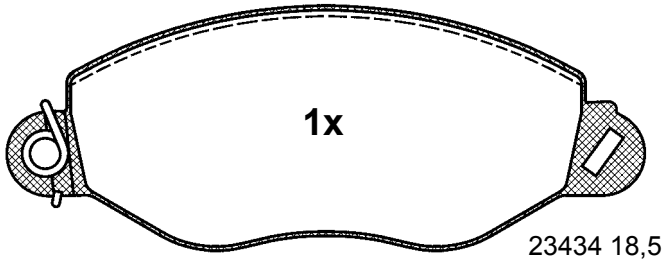

23434 18,5

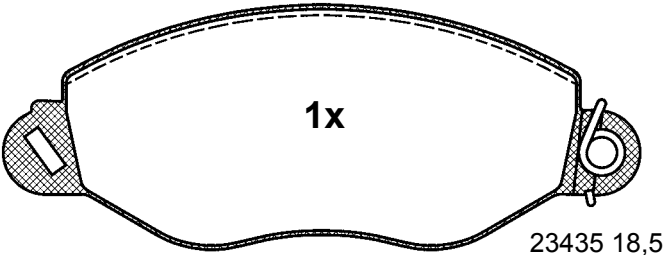

23435 18,5

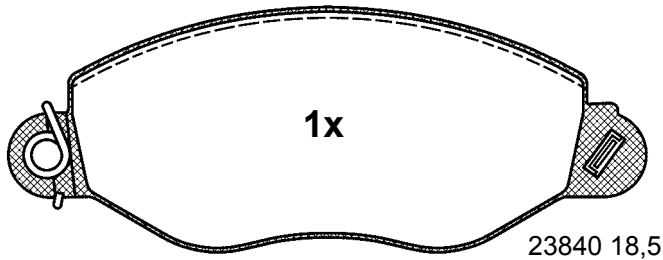

23840 18,5

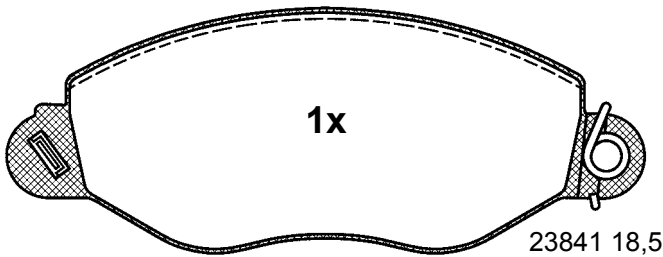

23841 18,5

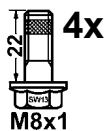

4x

168,6 x 64,0 x 18,5

## BA2263

MERCEDES BENZ

BOS

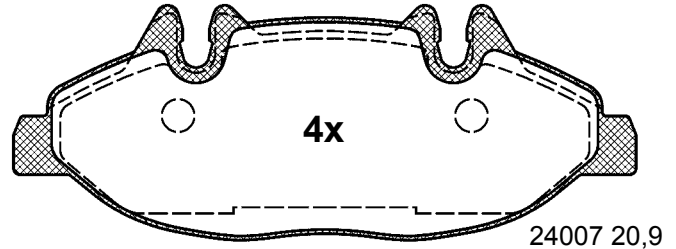

24007 20,9

164,8 x 61,8 x 20,9

2x

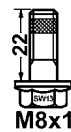

M8x1

## BA2264

MERCEDES BENZ

BOS

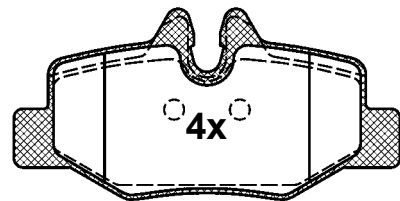

24008 17,7

101,8 x 50,3 x 17,7



4x

M8x1

# Abbildungen Scheibenbremsbeläge

Illustrations plaquettes de frein à disque / Illustrazioni pastiglie freno /

Figuras Calços do travão de disco / Rysunki okładzin hamulców tarczowych /

Zobrazení obložení kotoučových brzd

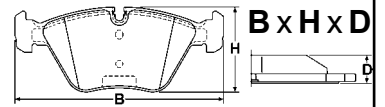

Maßstab - échelle - scala - escala - skala - měřítko 1:2

## BA2265



CITROËN, FIAT, PEUGEOT



BRE

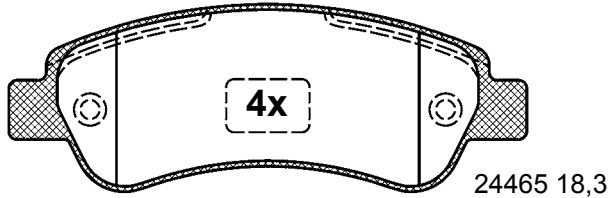

24465 18,3

136,9 x 49,0 x 18,3

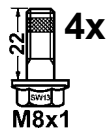

## BA2266



MERCEDES BENZ



LUC

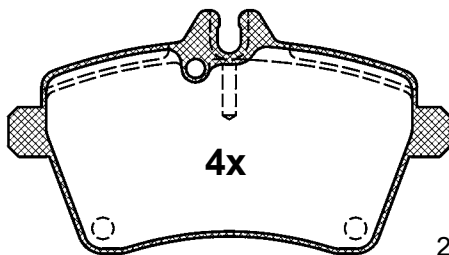

24077 18,3

116,5 x 63,8 x 18,3



## BA2268



MITSUBISHI, SMART, VOLVO



LUC

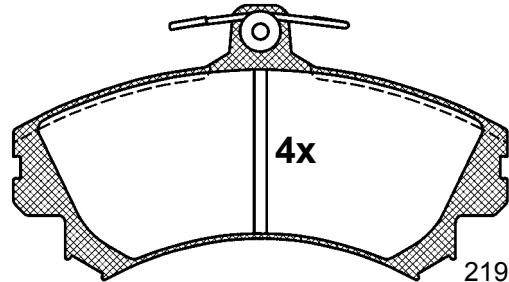

21920 15,1

129,9 x 72,8 x 15,1

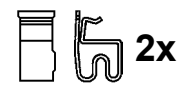

## BA2269



FORD, SEAT, VOLKSWAGEN



ATE

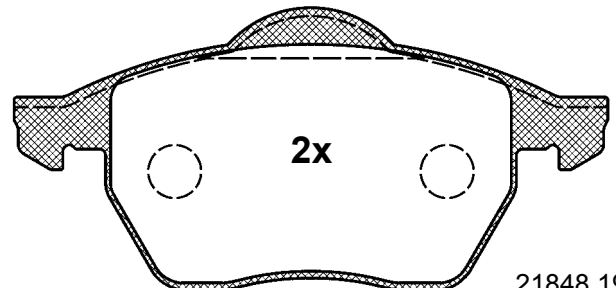

21848 19,6

156,3 x 74,0 x 19,6

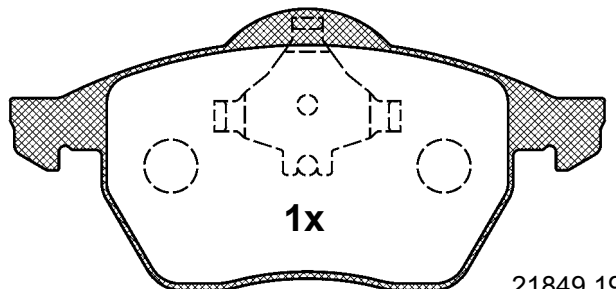

21849 19,6

156,3 x 74,0 x 19,6

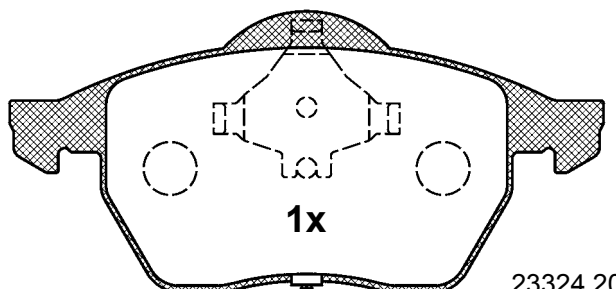

23324 20,6

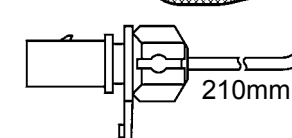

156,3 x 74,0 x 20,6

## BA2267



MINI



ATE

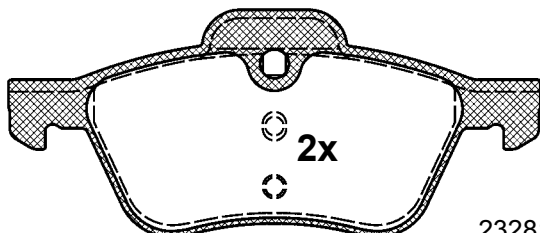

23281 18,3

140,2 x 59,7 x 18,3

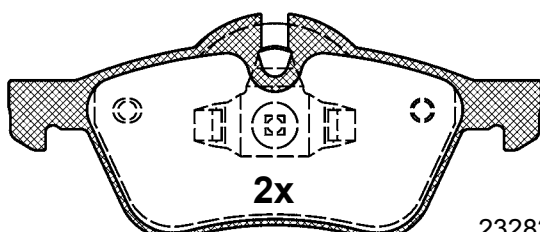

23282 18,3

140,2 x 58,7 x 18,3

# Abbildungen Scheibenbremsbeläge

Illustrations plaquettes de frein à disque / Illustrazioni pastiglie freno /  
 Figuras Calços do travão de disco / Rysunki okładzin hamulców tarczowych /  
 Zobrazení obložení kotoučových brzd

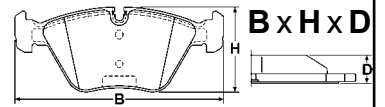

Maßstab - échelle - scala - escala - skala - měřítko 1:2

## BA2270

TOYOTA

LUC

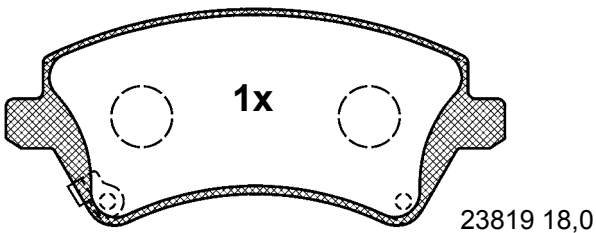
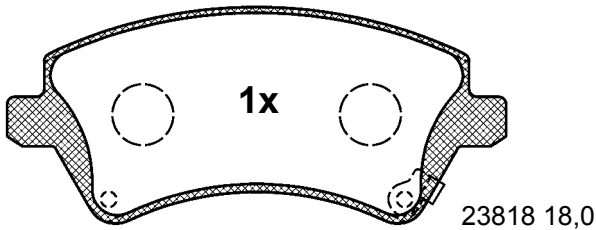
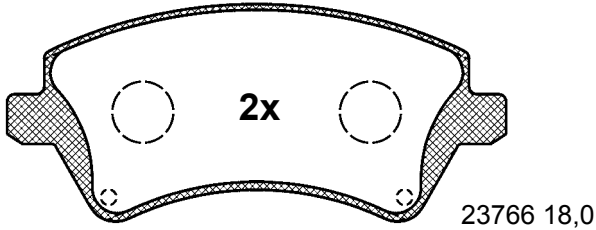

131,6 x 57,2 x 18,0

## BA2271

ALFA ROMEO, FIAT, LANCIA

LUC

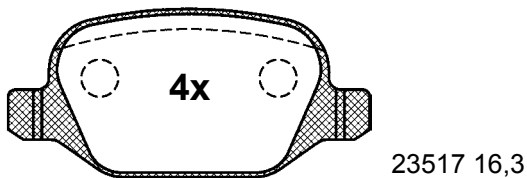

95,6 x 44,0 x 16,3



## BA2272

MINI

ATE

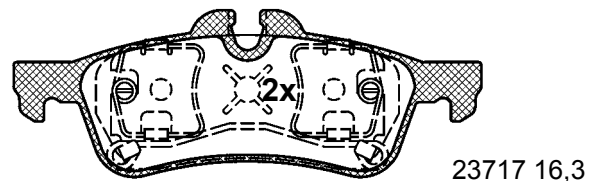
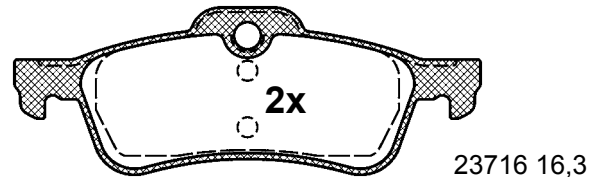

123,2 x 43,7 x 16,3

## BA2273

NISSAN

LUC

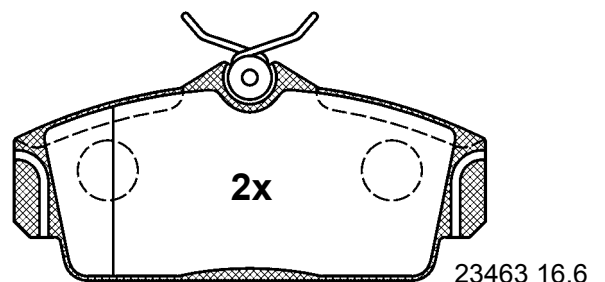
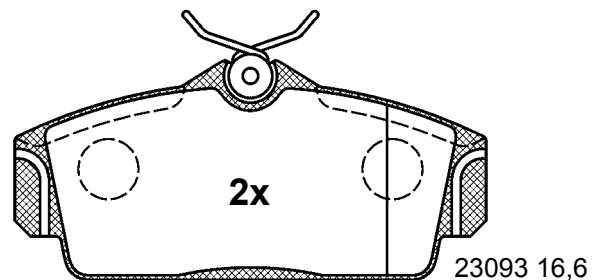

124,0 x 57,2 x 16,6

# Abbildungen Scheibenbremsbeläge

Illustrations plaquettes de frein à disque / Illustrazioni pastiglie freno /

Figuras Calços do travão de disco / Rysunki okładzin hamulców tarczowych /

Zobrazení obložení kotoučových brzd

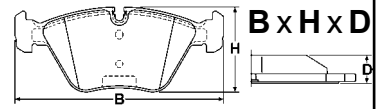

Maßstab - échelle - scala - escala - skala - měřítko 1:2

## BA2274

HONDA

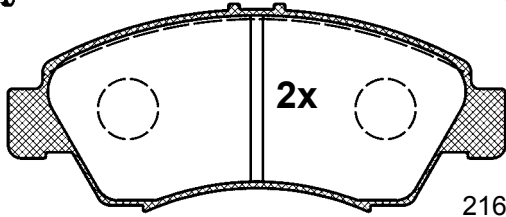

21697 15,0

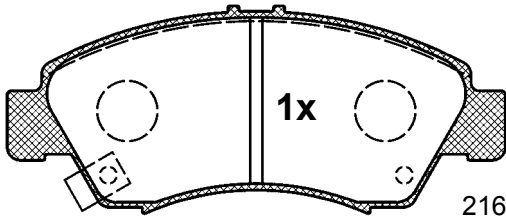

21698 15,0

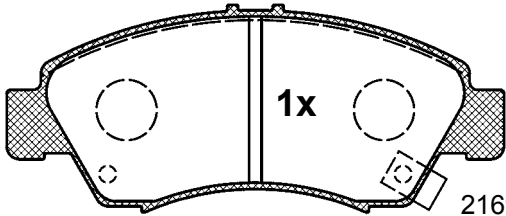

21699 15,0

131,3 x 54,6 x 15,0

## BA2276

FORD

BDX

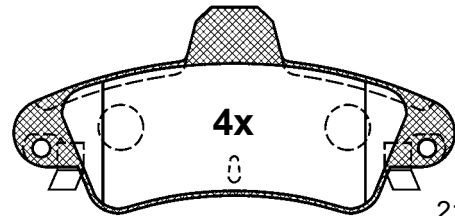

21586 15,7

115,9 x 53,7 x 15,7

## BA2275

CITROEN, FIAT, PEUGEOT

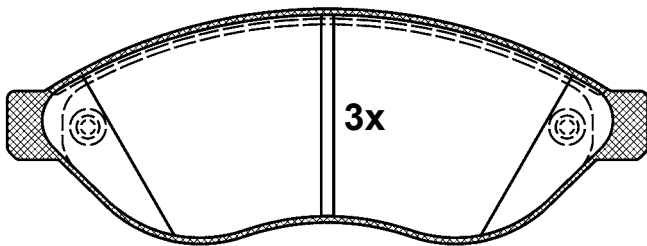

24468 18,5

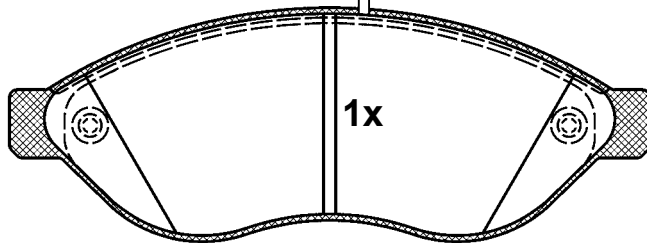
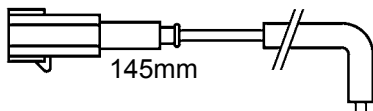

24469 18,5

168,9 x 61,7 x 18,5

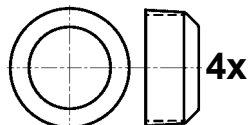
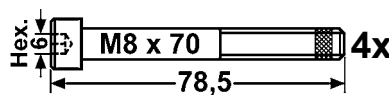

## BA2277

MERCEDES BENZ, VOLKSWAGEN

BOS

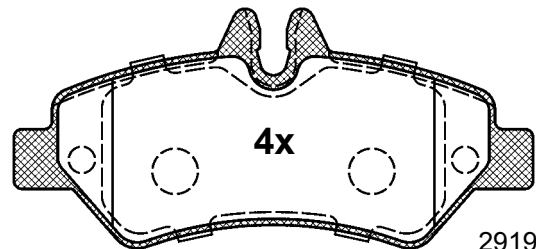

29190 19,6

136,9 x 63,2 x 19,6

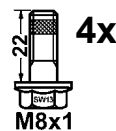

# Abbildungen Scheibenbremsbeläge

Illustrations plaquettes de frein à disque / Illustrazioni pastiglie freno /  
 Figuras Calços do travão de disco / Rysunki okładzin hamulców tarczowych /  
 Zobrazení obložení kotoučových brzd

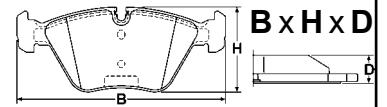

Maßstab - échelle - scala - escala - skala - měřítko 1:2

## BA2278



HONDA, MG, NISSAN



LUC

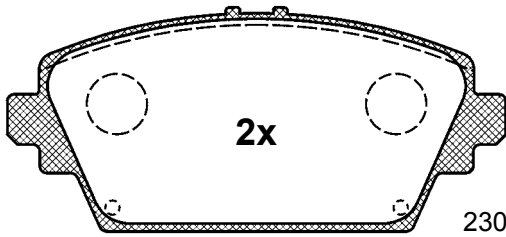

23094 16,5

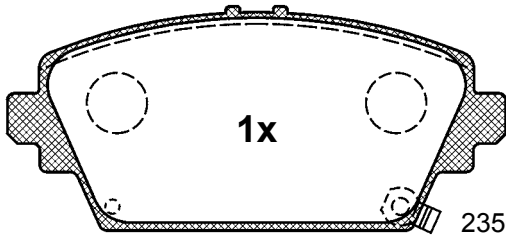

23563 16,5

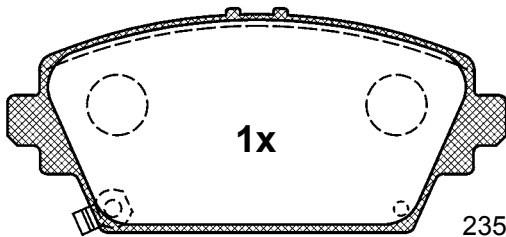

23564 16,5

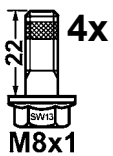

131,8 x 58,5 x 16,5

## BA2279



VOLVO



ATE

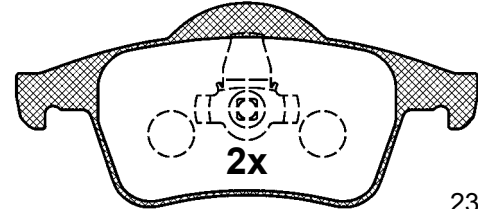

23076 17,2

122,6 x 53,7 x 17,2

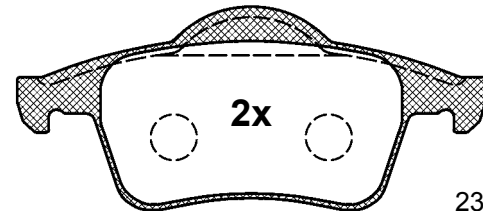

23077 17,2

123,8 x 53,7 x 17,2

## BA2280



HONDA, MG, ROVER, SUZUKI



AKE

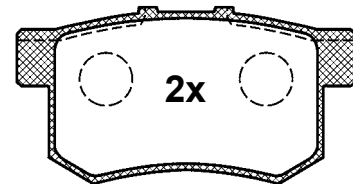

21719 15,0

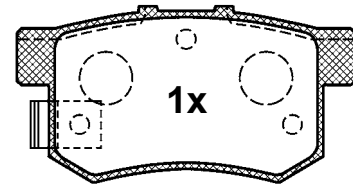

21720 15,0

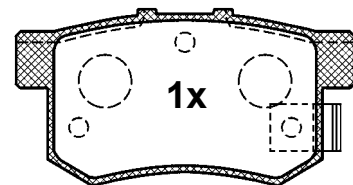

21721 15,0

88,9 x 47,1 x 15,0

# Abbildungen Scheibenbremsbeläge

Illustrations plaquettes de frein à disque / Illustrazioni pastiglie freno /  
Figuras Calços do travão de disco / Rysunki okładzin hamulców tarczowych /  
Zobrazení obložení kotoučových brzd

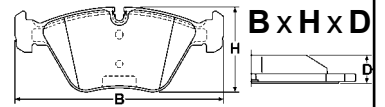

Maßstab - échelle - scala - escala - skala - měřítko 1:2

## BA2281

MERCEDES BENZ, VOLKSWAGEN BRE

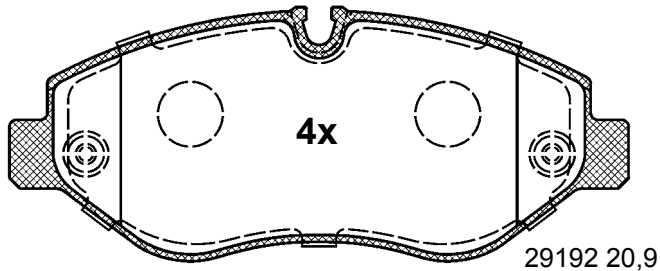

29192 20,9

163,2 x 66,8 x 20,9

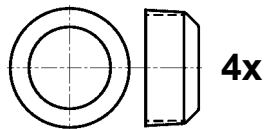
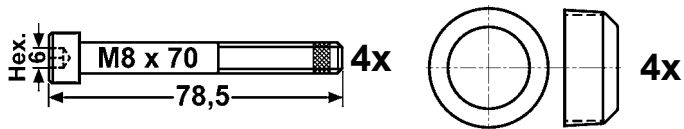

## BA2283

ALFA ROMEO, FIAT BOS

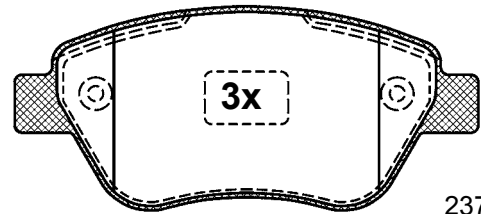

23707 17,8

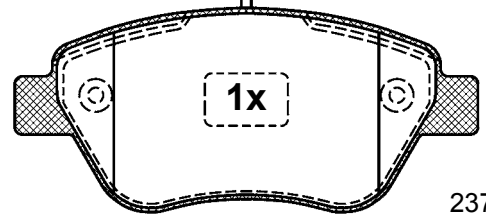

23706 17,8

122,9 x 53,2 x 17,8

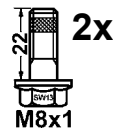

## BA2282

CITROEN LUC

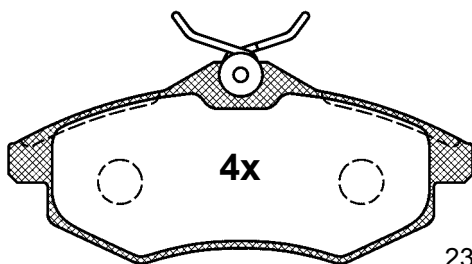

23407 19,3

122,6 x 53,0 x 19,3



## BA2284

DACIA, NISSAN, RENAULT LUC

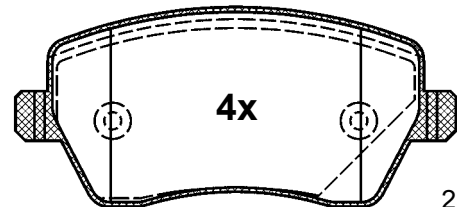

23973 17,3

116,4 x 52,4 x 17,3

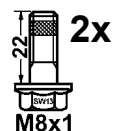



# Abbildungen Scheibenbremsbeläge

Illustrations plaquettes de frein à disque / Illustrazioni pastiglie freno /  
Figuras Calços do travão de disco / Rysunki okładzin hamulców tarczowych /  
Zobrazení obložení kotoučových brzd

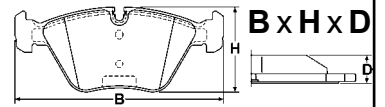

Maßstab - échelle - scala - escala - skala - měřítko 1:2

## BA2285



CITROEN, FIAT, LANCIA  
PEUGEOT



LUC

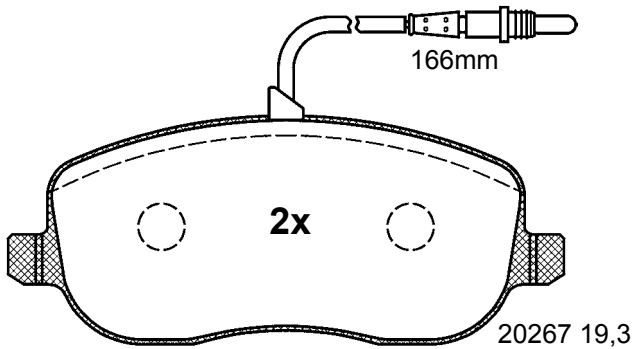
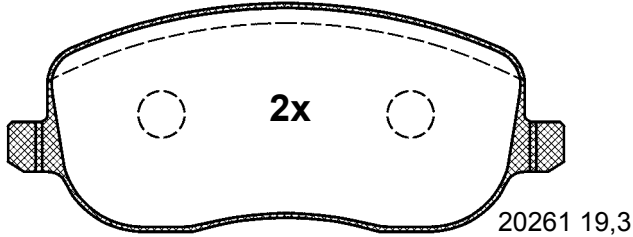

146,5 x 59,8 19,3



## BA2287



FORD, JAGUAR



BOS

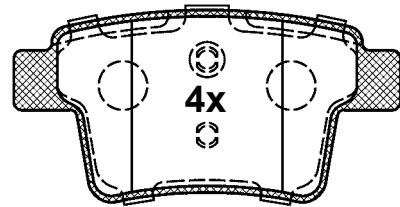

101,8 x 50,5 x 16,9

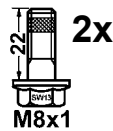

## BA2288



RENAULT



ATE

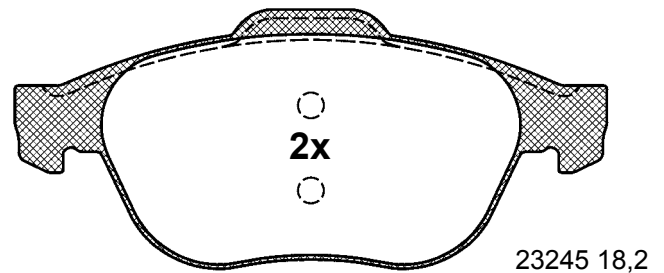

156,3 x 68,2 x 18,2

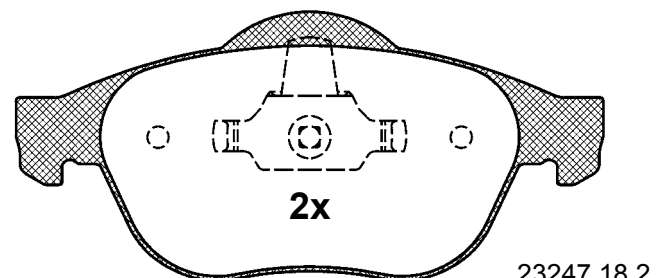

155,1 x 71,0 x 18,2

## BA2286



FORD



BDX

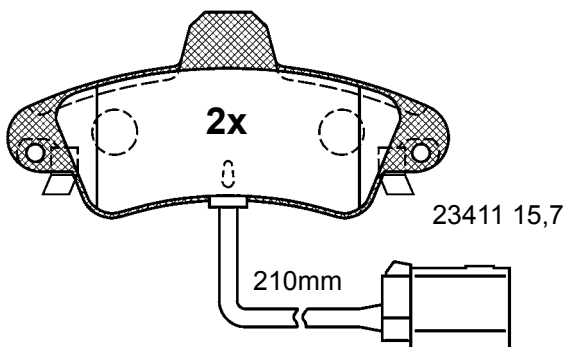
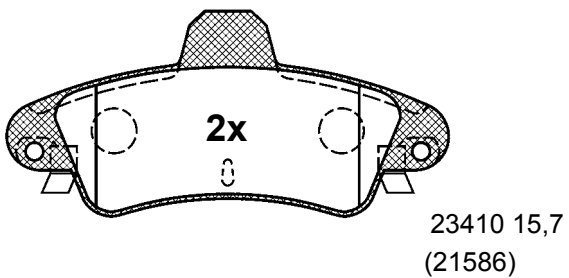

115,9 x 53,7 x 15,7

# Abbildungen Scheibenbremsbeläge

Illustrations plaquettes de frein à disque / Illustrazioni pastiglie freno /  
Figuras Calços do travão de disco / Rysunki okładzin hamulców tarczowych /  
Zobrazení obložení kotoučových brzd

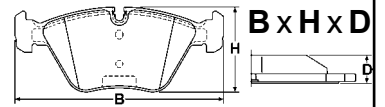

Maßstab - échelle - scala - escala - skala - měřítko 1:2

## BA2289



CITROEN, FIAT, LANCIA



BOS

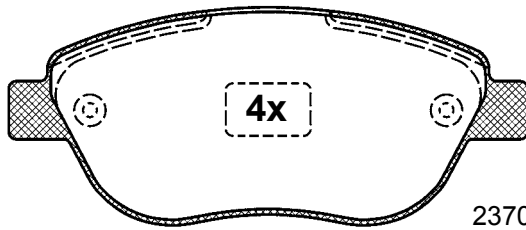

23708 18,4

136,9 x 57,6 x 18,4

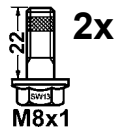

## BA2291



HYUNDAI, KIA



AKE

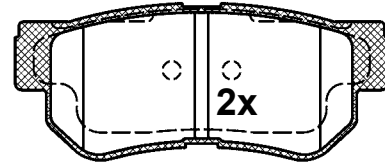

23543 15,7

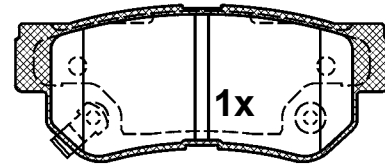

23544 15,7

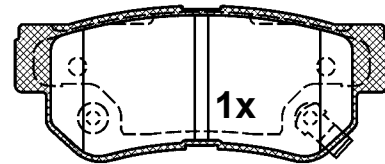

23545 15,7

98,6 x 40,9 x 15,7

## BA2290



MERCEDES BENZ



BOS

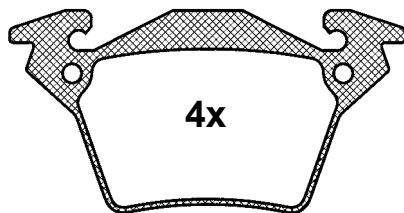

23020 17,9

105,1 x 52,9 x 17,9

## BA2292



HYUNDAI



AKE

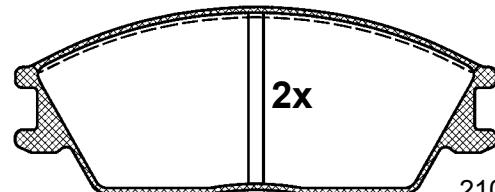

21012 15,0

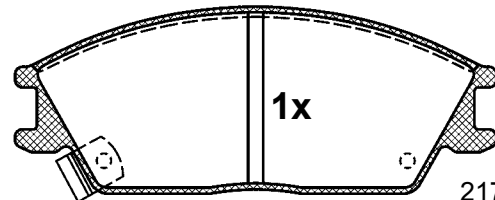

21773 15,0

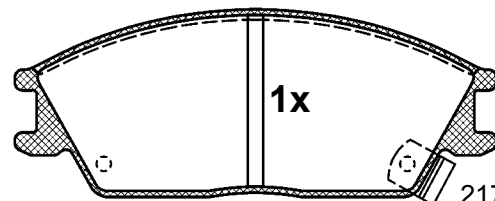

21774 15,0

127,5 x 49,0 x 15,0

# Abbildungen Scheibenbremsbeläge

Illustrations plaquettes de frein à disque / Illustrazioni pastiglie freno /  
 Figuras Calços do travão de disco / Rysunki okładzin hamulców tarczowych /  
 Zobrazení obložení kotoučových brzd

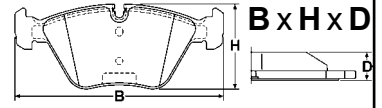

Maßstab - échelle - scala - escala - skala - měřítko 1:2

## BA2293

TOYOTA

SUM

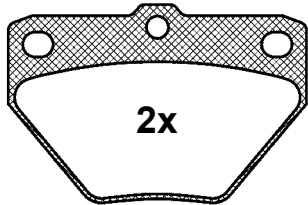

78,5 x 52,0 x 14,0

23521 14,0

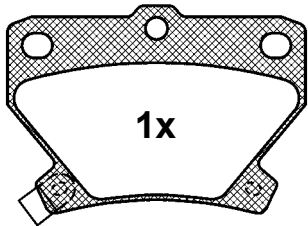

78,5 x 55,6 x 14,0

23522 14,0

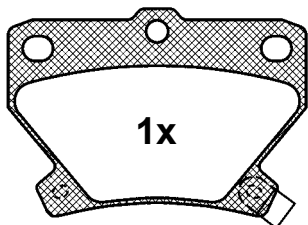

78,5 x 55,6 x 14,0

23523 14,0

## BA2294

TOYOTA

AKE

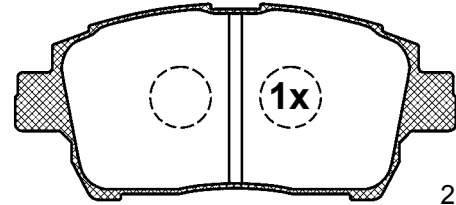

116,4 x 51,5 x 16,5

23510 16,5

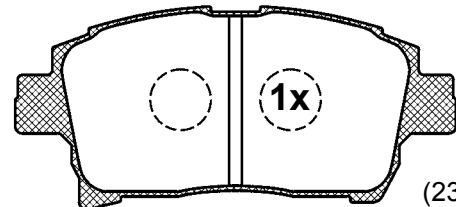

116,4 x 54,4 x 16,5

(23510) 16,5

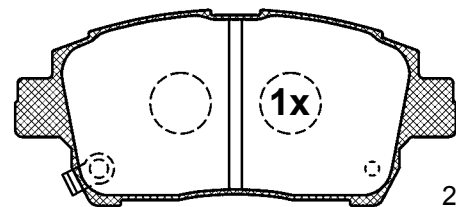

116,4 x 51,5 x 16,5

23511 16,5

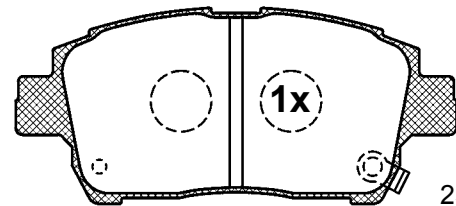

116,4 x 51,5 x 16,5

23512 16,5

# Abbildungen Scheibenbremsbeläge

Illustrations plaquettes de frein à disque / Illustrazioni pastiglie freno /

Figuras Calços do travão de disco / Rysunki okładzin hamulców tarczowych /

Zobrazení obložení kotoučových brzd

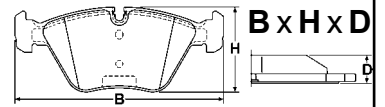

Maßstab - échelle - scala - escala - skala - měřítko 1:2

## BA2295

TOYOTA

BOS

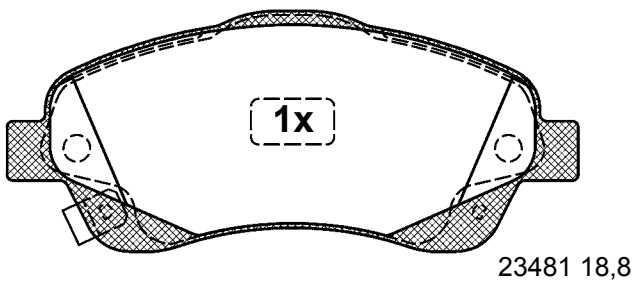
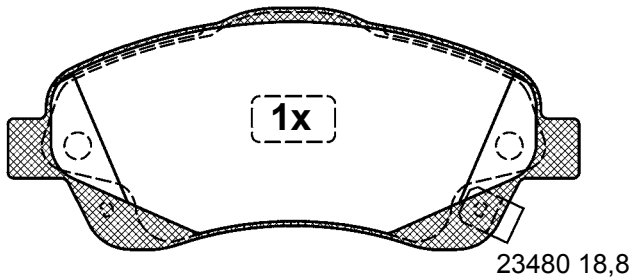
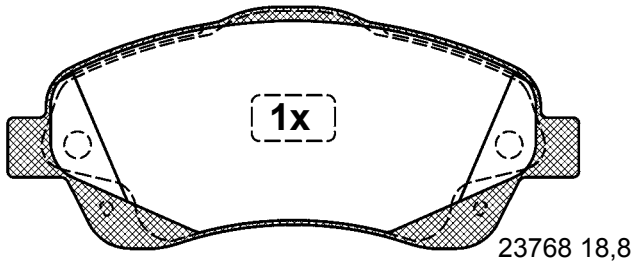
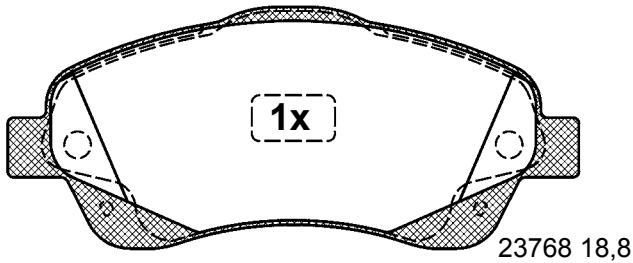

150,8 x 63,1 x 18,8

## BA2296

CITROEN, PEUGEOT, TOYOTA

BOS

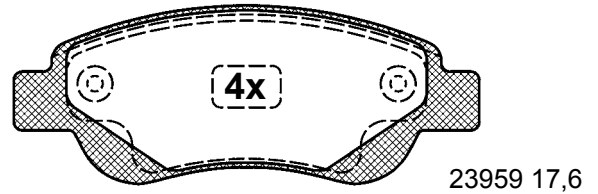

122,7 x 46,8 x 17,6

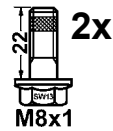

## BA2298

SEAT, SKODA, VOLKSWAGEN

LUC

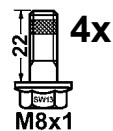
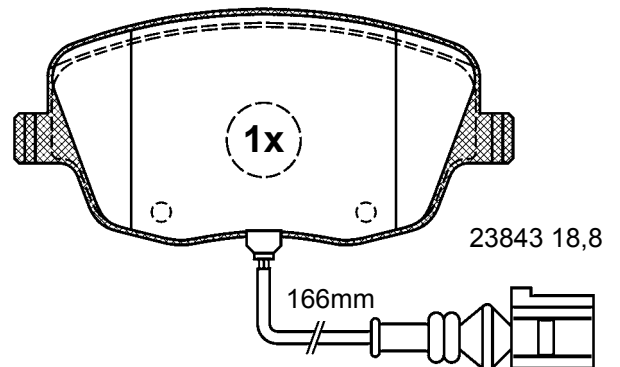
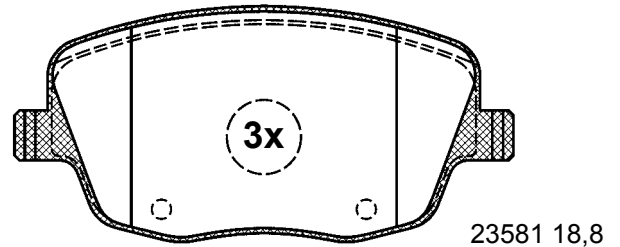

131,5 x 62,5 x 18,8

# Abbildungen Scheibenbremsbeläge

Illustrations plaquettes de frein à disque / Illustrazioni pastiglie freno /  
Figuras Calços do travão de disco / Rysunki okładzin hamulców tarczowych /  
Zobrazení obložení kotoučových brzd

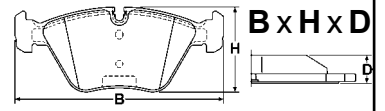

Maßstab - échelle - scala - escala - skala - měřítko 1:2

## BA2299



FIAT, LANCIA



BOS

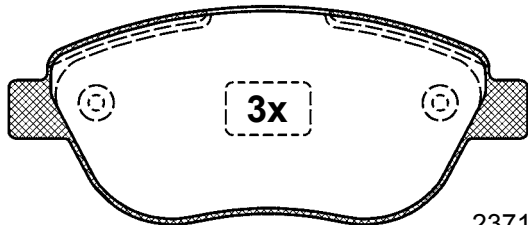

23710 19,4

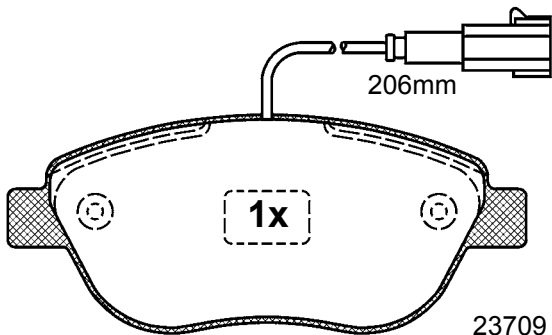

23709 19,4

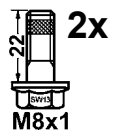

2x

136,9 x 57,6 x 19,4

M8x1

## BA2301



OPEL, SUZUKI, VAUXHALL



LUC

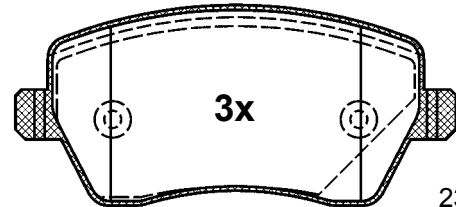

23973 17,3

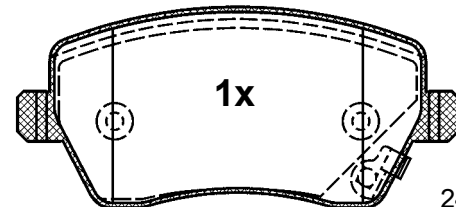

24403 17,3



4x

116,4 x 52,4 x 17,3

M8x21

## BA2300



CITROEN, PEUGEOT



BOS

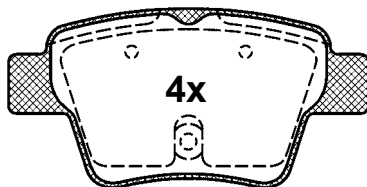

24150 17,6

94,7 x 46,9 x 17,6

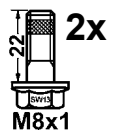

2x

M8x1

## BA2302



FIAT, FORD



BOS

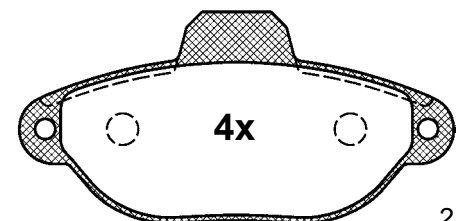

21436 17,0

115,0 x 55,2 x 17,0

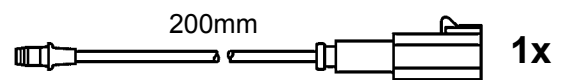

200mm

1x

# Abbildungen Scheibenbremsbeläge

Illustrations plaquettes de frein à disque / Illustrazioni pastiglie freno /

Figuras Calços do travão de disco / Rysunki okładzin hamulców tarczowych /

Zobrazení obložení kotoučových brzd

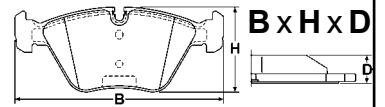

Maßstab - échelle - scala - escala - skala - měřítko 1:2

## BA2303



ALFA ROMEO, FIAT, LANCIA



BOS

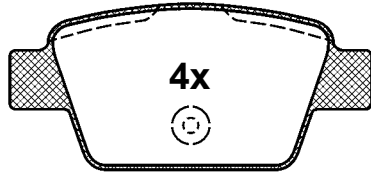

23714 16,3

94,9 x 42,9 x 16,3

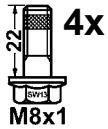

4x

M8x1

## BA2305



FORD



BOS

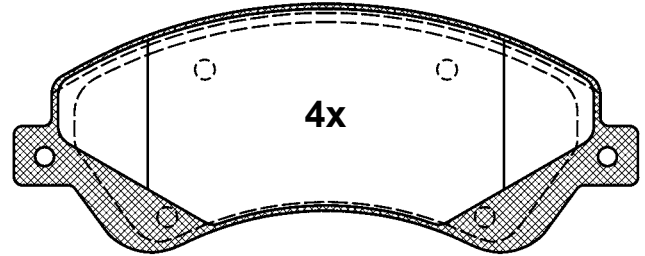

24485 18,8

164,8 x 65,5 x 18,8

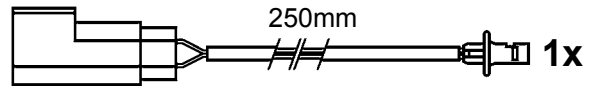

1x

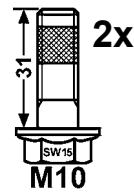

2x

M10

## BA2304



FORD



BOS

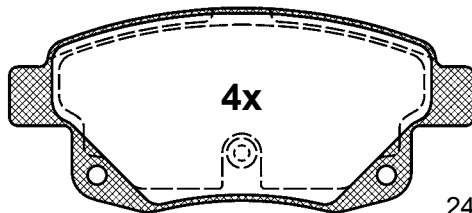

24486 17,3

122,9 x 54,0 x 17,3

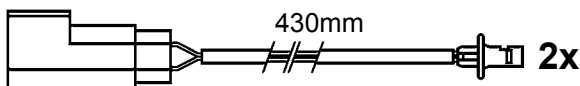

2x

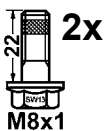

2x

M8x1

## BA2306



FORD



BOS

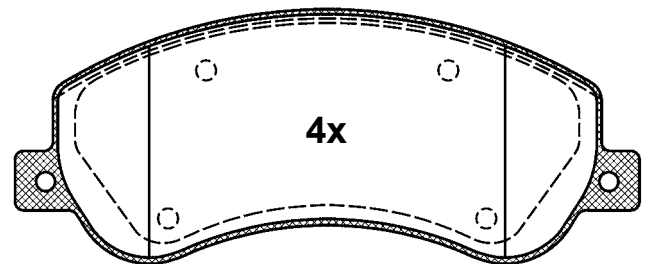

24484 18,8

164,8 x 66,8 x 18,8

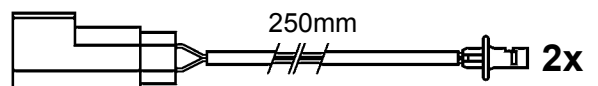

2x

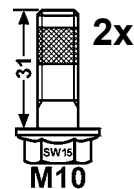

2x

M10

# Abbildungen Scheibenbremsbeläge

Illustrations plaquettes de frein à disque / Illustrazioni pastiglie freno /  
Figuras Calços do travão de disco / Rysunki okładzin hamulców tarczowych /  
Zobrazení obložení kotoučových brzd

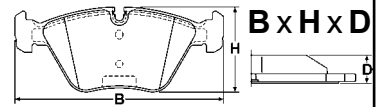

Maßstab - échelle - scala - escala - skala - měřítko 1:2

## BA2307



BMW, MINI



LUC

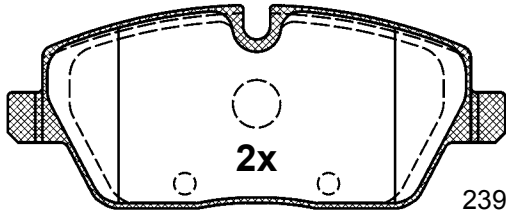

2x

23915 17,8

131,3 x 53,2 x 17,8

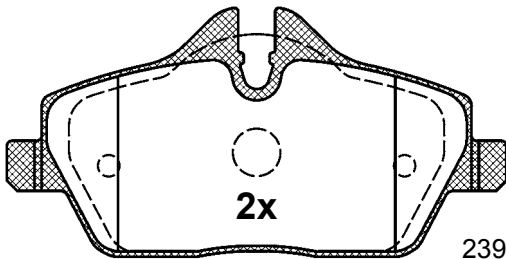

2x

23916 17,8

131,3 x 65,1 x 17,8



2x

M8x21

## BA2309



BMW



ATE

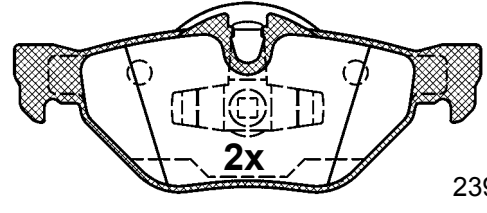

2x

23926 17,3

123,1 x 49,9 x 17,3

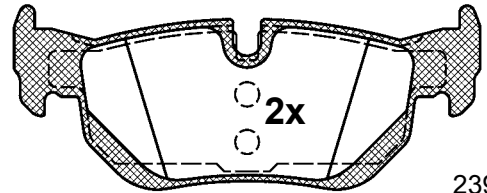

2x

23927 17,3

123,1 x 48,2 x 17,3

## BA2308



BMW, MINI



LUC

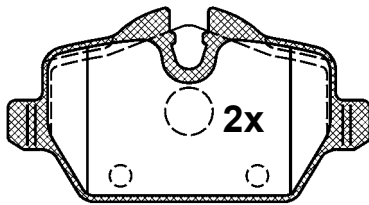

2x

23623 17,4

95,3 x 51,0 x 17,4

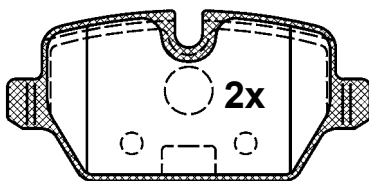

2x

23624 17,4

95,3 x 44,7 x 17,4



2x

M8x21

## BA2310



MERCEDES BENZ



LUC

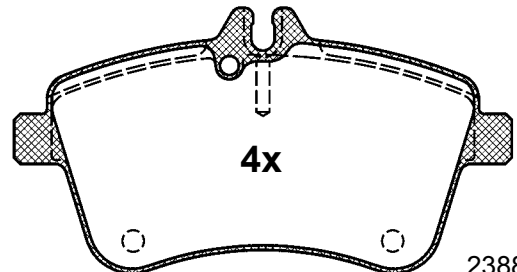

4x

23881 20,1

131,7 x 70,1 x 20,1



2x

M8x21

# Abbildungen Scheibenbremsbeläge

Illustrations plaquettes de frein à disque / Illustrazioni pastiglie freno /  
Figuras Calços do travão de disco / Rysunki okładzin hamulców tarczowych /  
Zobrazení obložení kotoučových brzd

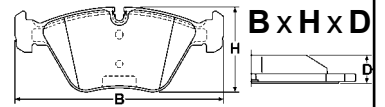

Maßstab - échelle - scala - escala - skala - měřítko 1:2

## BA2311

BMW

ATE

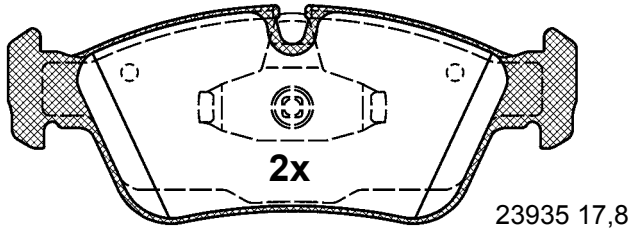

150,2 x 57,6 x 17,8

23935 17,8

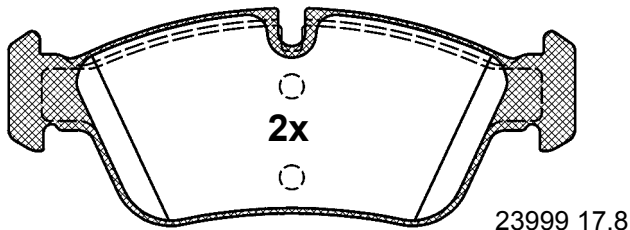

149,4 x 57,6 x 17,8

23999 17,8

## BA2314

FORD, LAND ROVER, VOLVO

ATE

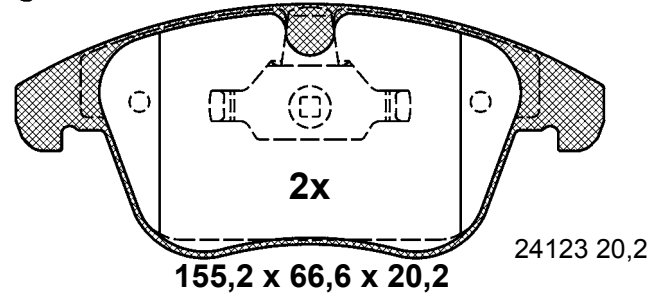

155,2 x 66,6 x 20,2

24123 20,2

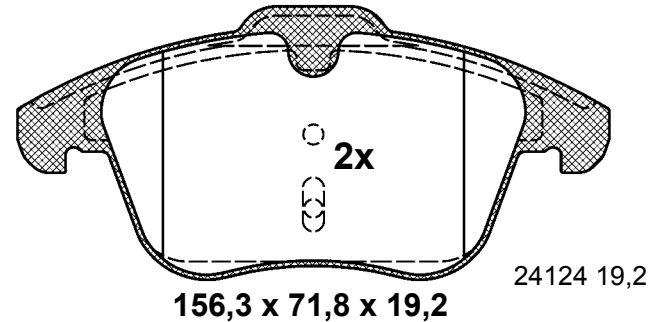

156,3 x 71,8 x 19,2

24124 19,2

## BA2313

FORD

LUC

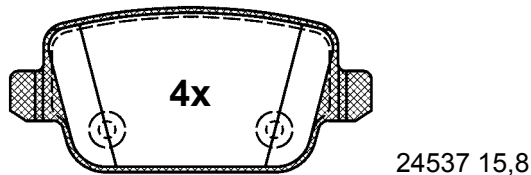

95,2 x 43,2 x 15,8

24537 15,8



## BA2315

ALFA ROMEO, FIAT, LANCIA

ATE

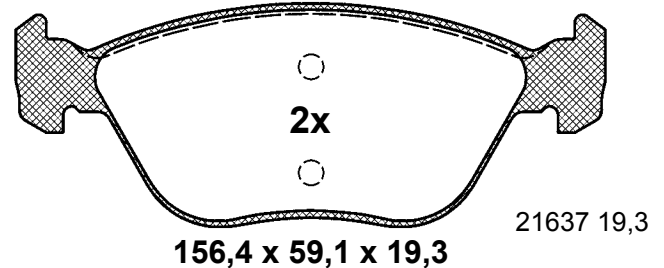

156,4 x 59,1 x 19,3

21637 19,3

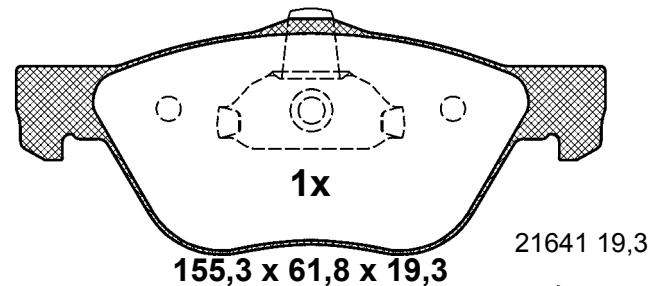

155,3 x 61,8 x 19,3

21641 19,3

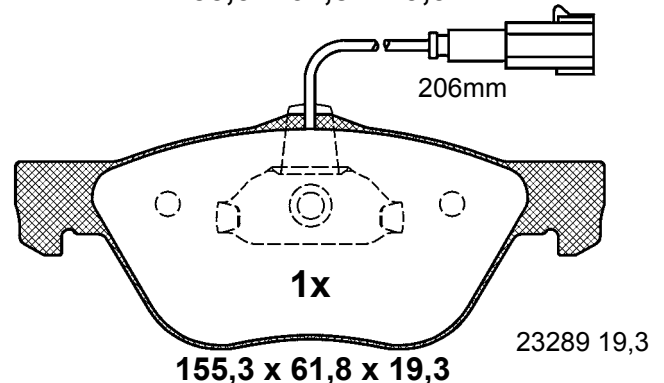

155,3 x 61,8 x 19,3

23289 19,3



# Abbildungen Scheibenbremsbeläge

Illustrations plaquettes de frein à disque / Illustrazioni pastiglie freno /  
Figuras Calços do travão de disco / Rysunki okładzin hamulców tarczowych /  
Zobrazení obložení kotoučových brzd

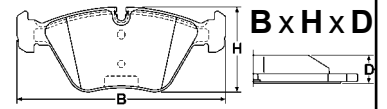

Maßstab - échelle - scala - escala - skala - měřítko 1:2

## BA2316



RENAULT



ATE

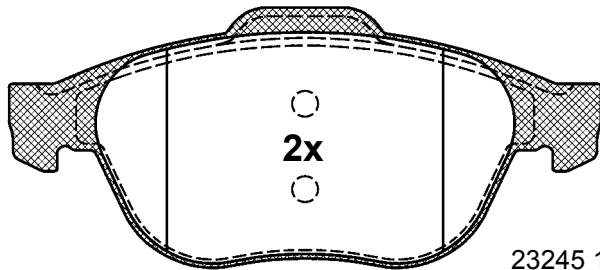

2x

23245 18,3

156,3 x 68,2 x 18,3

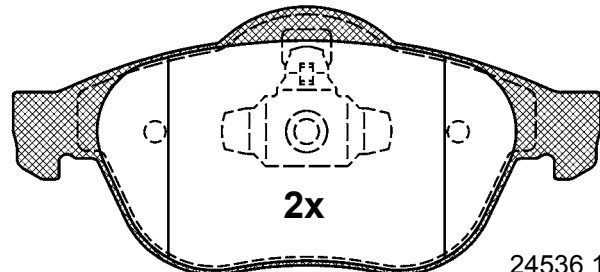

2x

24536 18,3

155,1 x 71,0 x 18,3

## BA2318



FORD, SEAT, VOLKSWAGEN



ATE

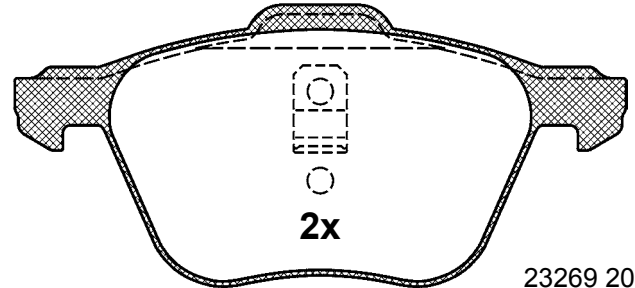

2x

23269 20,1

161,4 x 74,8 x 20,1

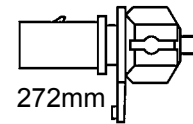

272mm

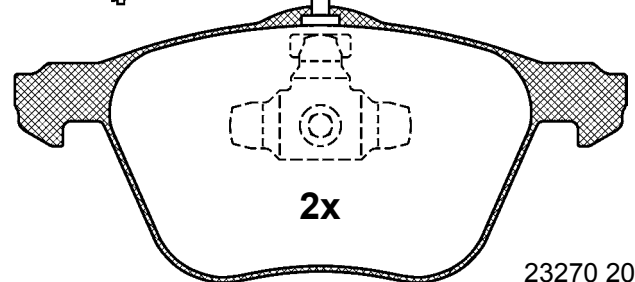

2x

23270 20,1

161,4 x 73,3 x 20,1

## BA2317



RENAULT



ATE

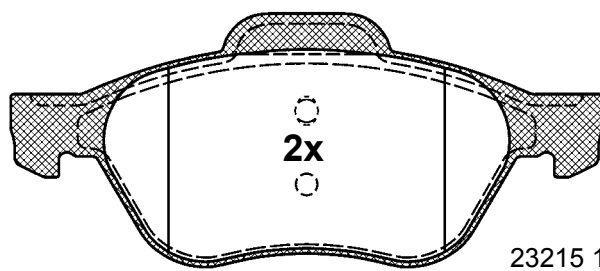

2x

23215 18,3

156,3 x 66,5 x 18,3

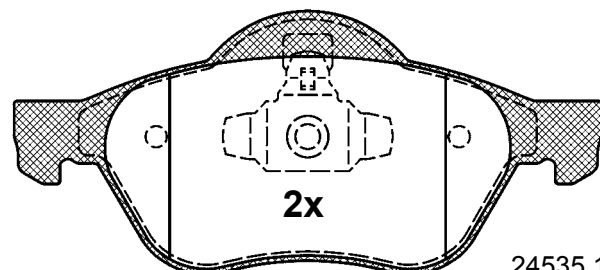

2x

24535 18,3

155,2 x 68,9 x 18,3

## BA2320



OPEL, RENAULT, VAUXHALL



BDX

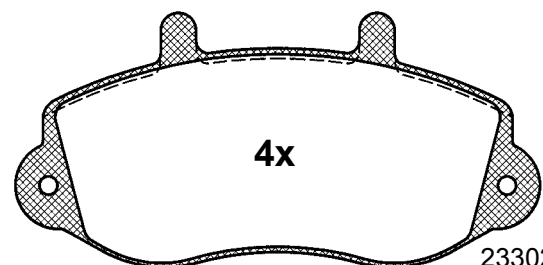

4x

23302 18,0

138,8 x 66,5 x 18,0

# Abbildungen Scheibenbremsbeläge

Illustrations plaquettes de frein à disque / Illustrazioni pastiglie freno /

Figuras Calços do travão de disco / Rysunki okładzin hamulców tarczowych /

Zobrazení obložení kotoučových brzd

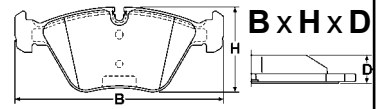

Maßstab - échelle - scala - escala - skala - měřítko 1:2

## BA2321



VOLKSWAGEN



LUC

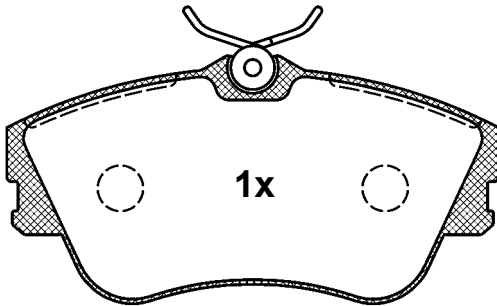

1x

21479 19,2

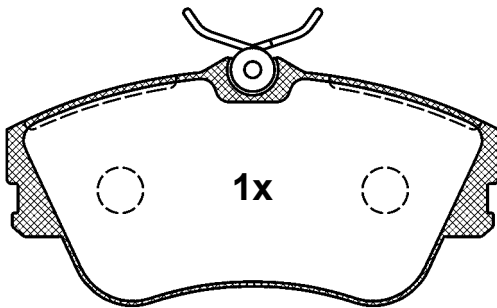

1x

21479 19,2

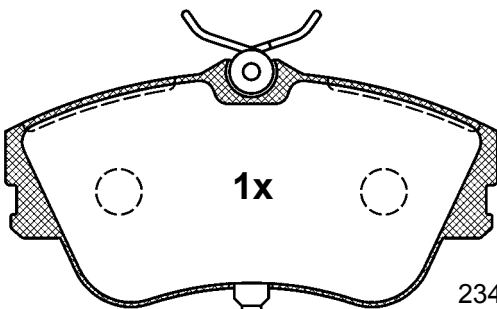

1x

23445 19,2

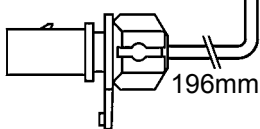

196mm

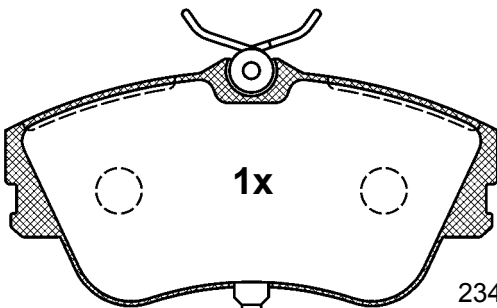

1x

23445 19,2



2x

M8x21

129,5 x 65,3 x 19,2

## BA2322



VOLKSWAGEN



LUC

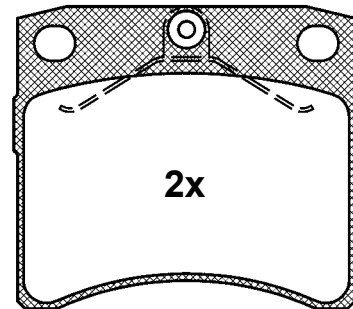

2x

20651 18,2

91,5 x 80,1 x 18,2

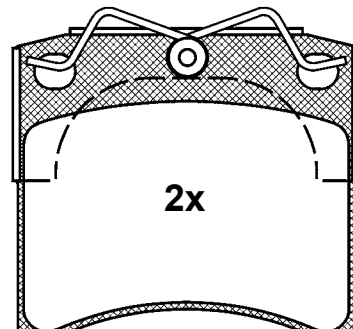

2x

21635 18,2

91,7 x 81,3 x 18,2

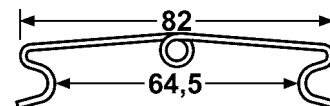

82

64,5

## BA2323



CITROEN, FIAT, PEUGEOT



BRE

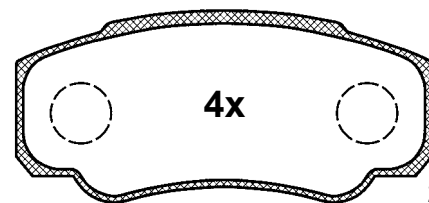

4x

23921 20,0

109,6 x 49,9 x 20,0

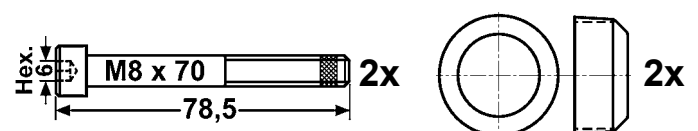

6x

M8 x 70

2x

78,5

2x

# Abbildungen Scheibenbremsbeläge

Illustrations plaquettes de frein à disque / Illustrazioni pastiglie freno /  
 Figuras Calços do travão de disco / Rysunki okładzin hamulców tarczowych /  
 Zobrazení obložení kotoučových brzd

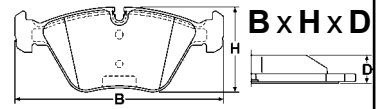

Maßstab - échelle - scala - escala - skala - měřítko 1:2

## BA2324



CITROEN, FIAT, PEUGEOT



BRE

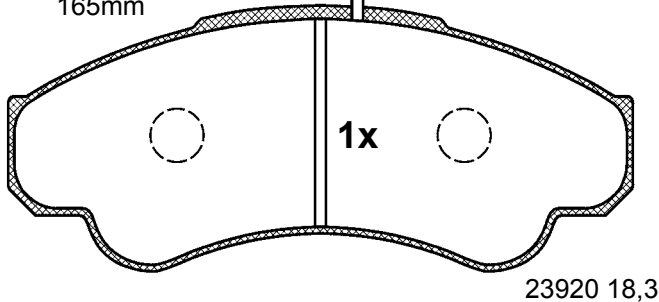
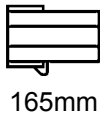
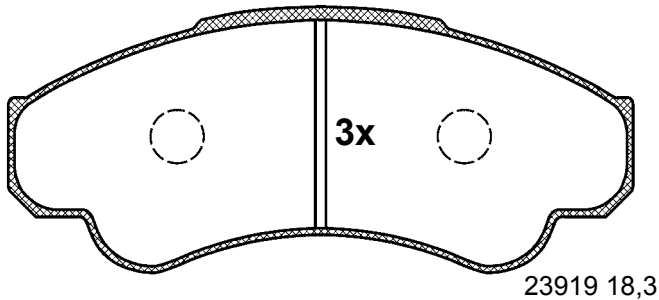

164,8 x 69,4 x 18,3

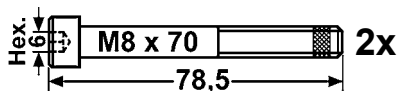
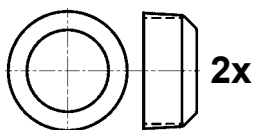

## BA2325



CITROEN, FIAT, PEUGEOT



LUC

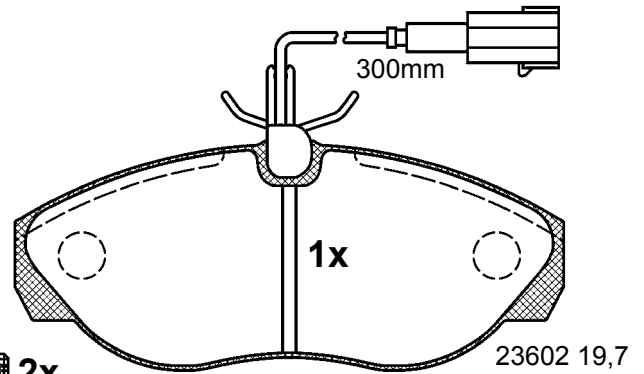
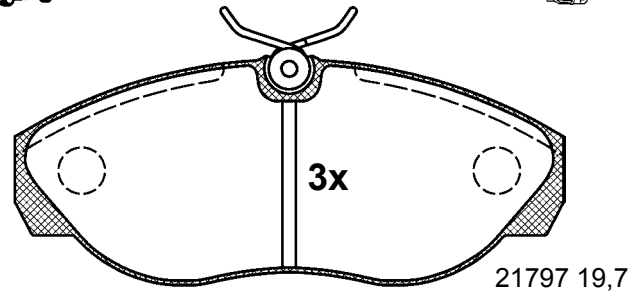

145,0 x 61,0 x 19,7

## BA2326



TOYOTA



BOS

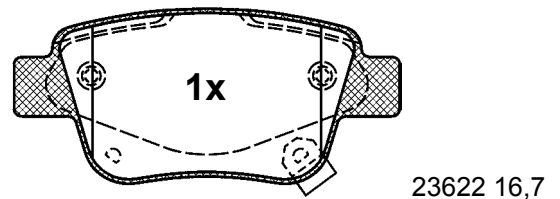
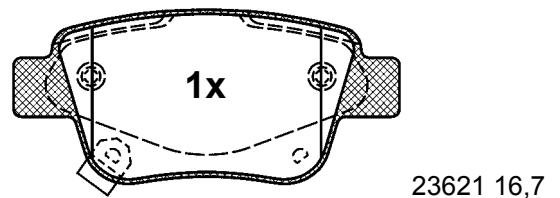
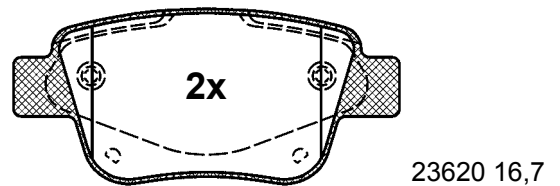

101,9 x 46,0 x 16,7

# Abbildungen Scheibenbremsbeläge

Illustrations plaquettes de frein à disque / Illustrazioni pastiglie freno /

Figuras Calços do travão de disco / Rysunki okładzin hamulców tarczowych /

Zobrazení obložení kotoučových brzd

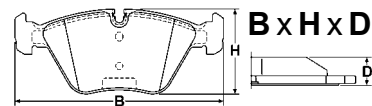

Maßstab - échelle - scala - escala - skala - měřítko 1:2

## BA2327



VOLKSWAGEN



ATE

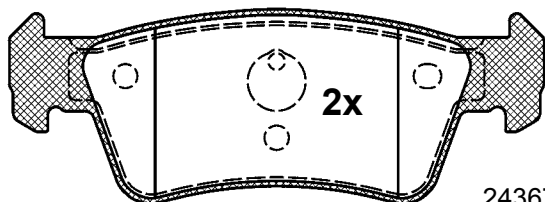

24367 19,1

141,5 x 51,0 x 19,1

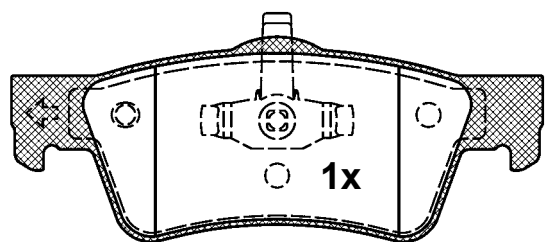

19,1

140,7 x 54,0 x 19,1

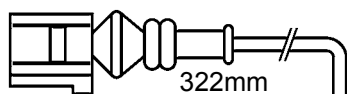

322mm

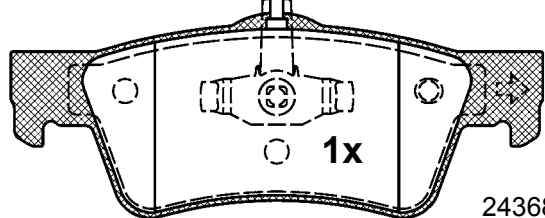

24368 19,1

140,7 x 54,0 x 19,1

## BA2328



CITROEN, FIAT, PEUGEOT



BRE

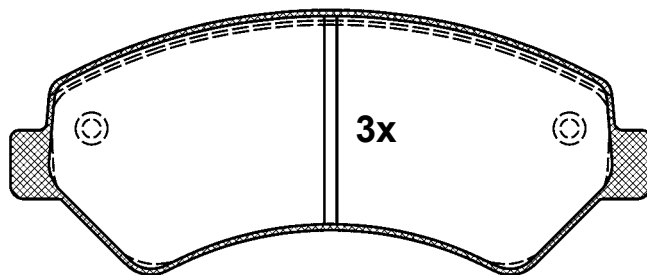

24466 19,1

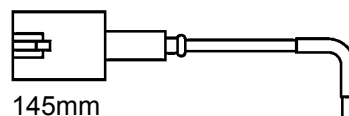

145mm

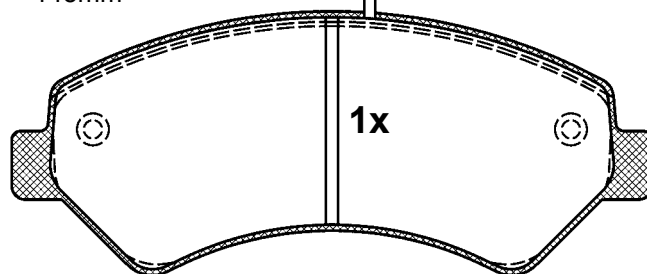

24467 19,1

169,1 x 69,4 x 19,1

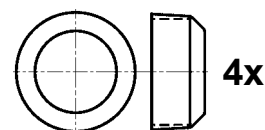

4x

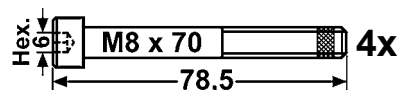

Hex.

M8 x 70

4x

78,5

# Abbildungen Scheibenbremsbeläge

Illustrations plaquettes de frein à disque / Illustrazioni pastiglie freno /  
Figuras Calços do travão de disco / Rysunki okładzin hamulców tarczowych /  
Zobrazení obložení kotoučových brzd

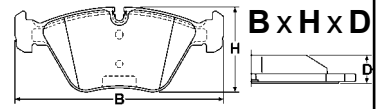

Maßstab - échelle - scala - escala - skala - měřítko 1:2

## BA2329



CITROEN, FIAT, PEUGEOT

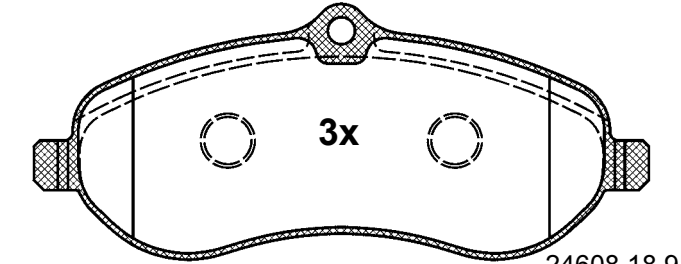

24608 18,9

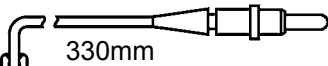

330mm

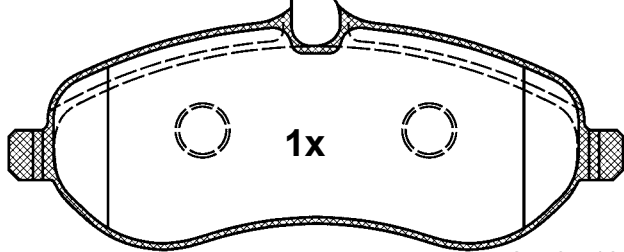

24595 18,9

162,1 x 66,9 x 18,9



M8x21

## BA2331



TOYOTA

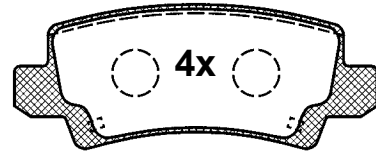

23816 16,1

95,6 x 38,0 x 16,1



2x

## BA2330



CITROEN, FIAT, PEUGEOT

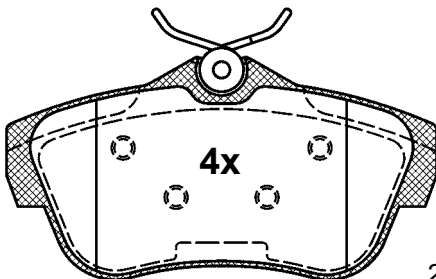

24578 16,3

113,4 x 58,6 x 16,3



M8x21

## BA2332



FIAT, LANCIA

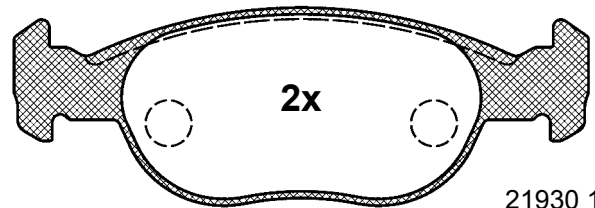

21930 17,9

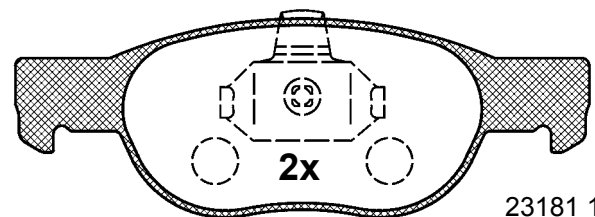

23181 17,9

151,4 x 52,0 x 17,9

# Abbildungen Scheibenbremsbeläge

Illustrations plaquettes de frein à disque / Illustrazioni pastiglie freno /

Figuras Calços do travão de disco / Rysunki okładzin hamulców tarczowych /

Zobrazení obložení kotoučových brzd

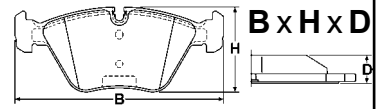

Maßstab - échelle - scala - escala - skala - měřítko 1:2

## BA2333



AUDI, SEAT, SKODA,  
VOLKSWAGEN

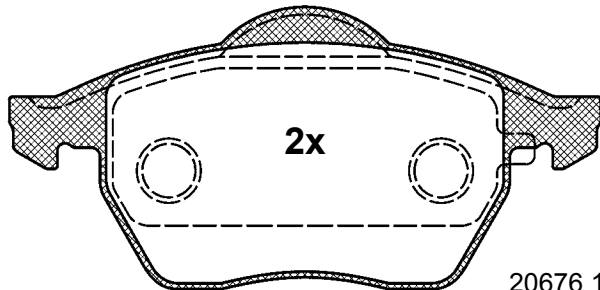

20676 19,8

156,3 x 74,1 x 19,8

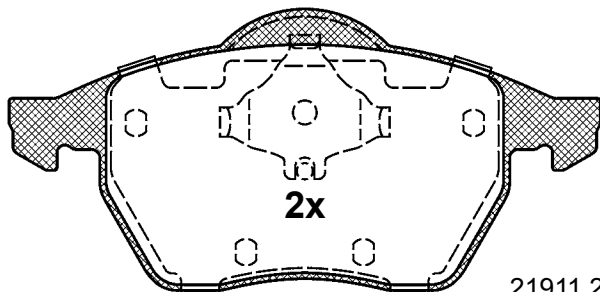

21911 20,3

156,3 x 74,1 x 20,3

## BA2335



DACIA

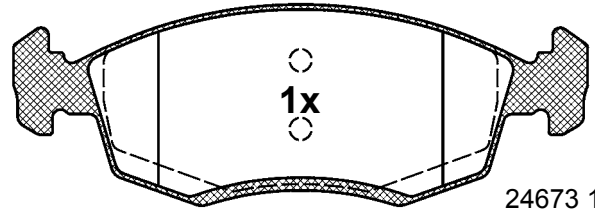

24673 18,0

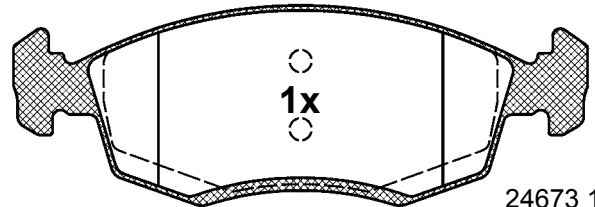

24673 18,0

## BA2334



FIAT

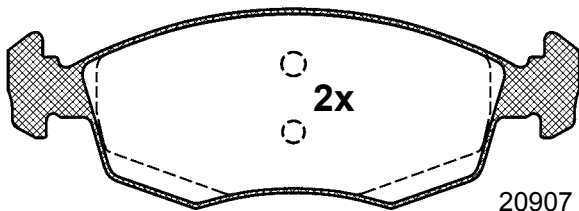

20907 18,0

151,5 x 52,6 x 18,0

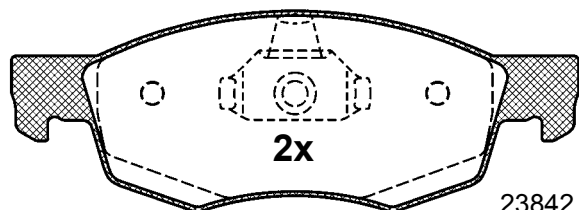

23842 18,0

150,1 x 52,6 x 18,0

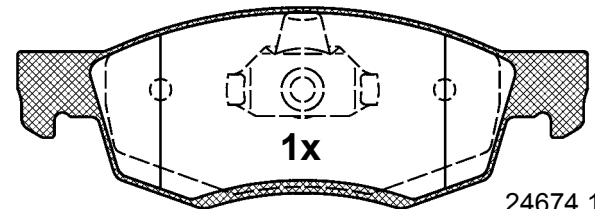

24674 18,0

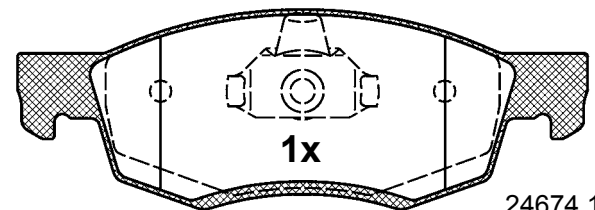







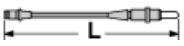

24674 18,0

150,2 x 52,6 x 18,0

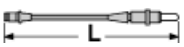





# Abbildungen Warnkontakte

Illustrations témoins d'usure / Illustrazioni rilevatori usura / Figuras avisador de desgaste /  
Rysunki styki ostrzegawcze / Zobrazení kontaktů indikátoru opotřebení

BAV1001				OE - #	
  	<b>MERCEDES BENZ</b> (W124) E-Klasse (85-93) (W201) 190-190 E 2,6 (82-93) E-Klasse (W124) (93-97)	2x		201 540 03 17	
		2x			
68 mm (170)mm		2x			
BAV1002				OE - #	
  	<b>BMW</b> 3er Reihe/E30 (82-93) Z1 (88-91)	1x		34 35 9 058 889	
		1x			
250 mm					
BAV1003				OE - #	
  	<b>BMW</b> 5er Reihe/E28 (81-87) 5er Reihe/E34 (88-96) 6er Reihe/E24 (76-89) 7er Reihe/E32 (86-94) 8er Reihe/E31 (90-99)	1x		34 35 1 179 820	
		1x	1x		34 35 1 180 432
			1x		
			1x	1x	
			1x	1x	
230 mm					

# Abbildungen Warnkontakte







Illustrations témoins d'usure / Illustrazioni rilevatori usura / Figuras avisador de desgaste /  
Rysunki styki ostrzegawcze / Zobrazení kontaktů indikátoru opotřebení

BAV1004			OE - #
   94 mm	<b>MERCEDES BENZ</b> (R107) 280 SL-560 SL (71-89) (R129) SL-Klasse (89-93) (W116) 280 S-450 SEL 6,9 (72-80) (W123) 200-300 TD Turbo (76-85) (W124) E-Klasse (85-93) (W126) 260 SE-560 SEC (80-91) (W201) 190-190 E 2,6 (82-93) A-Klasse (W168) (97-04) C-Klasse (S202) Kombi (96-01) C-Klasse (W202) Limousine (93-00) CLK-Klasse (A208) Cabrio (98-03) CLK-Klasse (C208) Coupe (97-02) CL-Klasse (C140) Coupe (96-99) E-Klasse (S210) Kombi (96-03) E-Klasse (W124) (93-97) E-Klasse (W210) Limousine (95-02) G-Klasse (W460) (79-93) S-Klasse (W140) (91-93) S-Klasse (W140) (93-98) SLK-Klasse (R170) (96-04) SL-Klasse (R129) (93-01) Transporter (BM 601) 207 D-210 D Transporter (BM 602) 307 D-310 D Transporter (BM 611) 407 D-410 D Transporter (BM 667) 507 D-510	4x 4x 4x 4x 4x 4x 4x 4x 4x 4x 4x 1x 2x 1x 2x 1x 2x 1x 2x 1x 4x 4x 2x 2x 4x 4x 2x 2x 4x 4x 4x 4x 4x 2x 2x 2x 4x 4x 4x 4x 4x	126 540 20 17 140 540 12 17
	<b>BMW</b> 3er Reihe/E36 (91-00)	1x	34 35 1 181 342
<b>BAV1005</b>			<b>OE - #</b>
   790 mm	<b>BMW</b> 3er Reihe/E36 (91-00)	1x	34 35 1 181 342



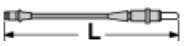

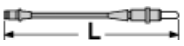

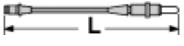



# Abbildungen Warnkontakte

Illustrations témoins d'usure / Illustrazioni rilevatori usura / Figuras avisador de desgaste /  
Rysunki styki ostrzegawcze / Zobrazení kontaktů indikátoru opotřebení

BAV1006				OE - #
  790 mm	<b>BMW</b> 3er Reihe/E36 (91-00) Z3 (95-02)	1x		34 35 1 181 338
			1x	
BAV1007				OE - #
  265 mm	<b>BMW</b> 3er Reihe/E30 (82-93) 5er Reihe/E28 (81-87) 6er Reihe/E24 (76-89) Z1 (88-91)	1x	1x	34 35 1 179 819
			1x	
BAV1008				OE - #
  84 mm (185)mm	<b>MERCEDES BENZ</b> G-Klasse (W461) (90-) G-Klasse (W463) (90-) G-Klasse (W463) Cabrio (90-) V-Klasse (BM638) (96-03) VITO (BM638) (96-03) Transporter (BM 901/902) SPRINTER (95-06) Transporter (BM 903/904) SPRINTER (95-06) Transporter (BM 905) SPRINTER (01-06)	2x		901 540 00 17 901 540 01 17
		<b>VOLKSWAGEN</b> LT/- 4x4 (96-)	2x	













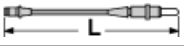

# Abbildungen Warnkontakte

Illustrations témoins d'usure / Illustrazioni rilevatori usura / Figuras avisador de desgaste /  
Rysunki styki ostrzegawcze / Zobrazení kontaktů indikátoru opotřebení

BAV1009			OE - #
   830 mm	<b>BMW</b> 5er Reihe/E39 (96-03)	1x	34 35 2 229 018
BAV1010			OE - #
   550 mm	<b>BMW</b> 5er Reihe/E39 (96-03) Z8 (00-03)	1x  1x	34 35 1 163 066
BAV1011			OE - #
   840 mm	<b>BMW</b> 3er Reihe/E36 (91-00) Z3 (95-02)	1x  1x	34 35 1 182 533











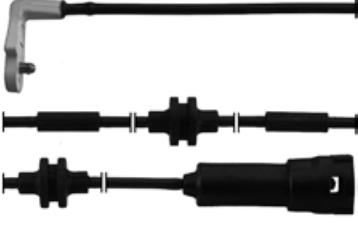

# Abbildungen Warnkontakte

Illustrations témoins d'usure / Illustrazioni rilevatori usura / Figuras avisador de desgaste /  
Rysunki styki ostrzegawcze / Zobrazení kontaktů indikátoru opotřebení

BAV1012			OE - #
  	<b>BMW</b> 3er Reihe/E46 (98-06) Z4 Roadster/E85 (03-08)	1x 1x	34 35 1 164 371
	 596 mm		
BAV1013			OE - #
  	<b>BMW</b> 3er Reihe/E46 (98-06)	1x	34 35 1 164 372
	 1334 mm		
BAV1014			OE - #
  	<b>OPEL</b> ASTRA G / Vauxhall Astra MKIV (98-04) ZAFIRA I / Vauxhall Zafira I (99-05)	2x 2x	12 38 442 13122323
	<b>SAAB</b> 9-3 Limousine (YS3D) (98-02) 9-3 Coupe (YS3D) (98-02) 9-3 Cabriolet (YS3D) (98-03) 9-5 Limousine (YS3E) (97-10) 9-5 Kombi (YS3E) (98-10) 900 (94-98)	2x 2x 2x 2x 2x 2x	
 740 mm			
BAV1015			OE - #
  	<b>BMW</b> 5er Reihe/E39 (96-03)	1x	34 35 1 163 207
	 1100 mm		







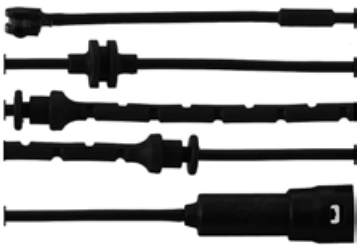

# Abbildungen Warnkontakte

Illustrations témoins d'usure / Illustrazioni rilevatori usura / Figuras avisador de desgaste /  
Rysunki styki ostrzegawcze / Zobrazení kontaktů indikátoru opotřebení

BAV1016			OE - #
  660 mm	<b>OPEL</b> VECTRA B / Vauxhall Vectra (96-02)	2x	62 38 388 90497051
BAV1017			OE - #
  730 mm	<b>OPEL</b> OMEGA B / Vauxhall Omega (94-03)	2x	62 38 323 90495144
BAV1018			OE - #
  800 mm	<b>BMW</b> X5 (00-07)	1x	34 35 1 165 579
BAV1019			OE - #
  715 mm	<b>BMW</b> X5 (00-07)	1x	34 35 1 165 580







# Abbildungen Warnkontakte

Illustrations témoins d'usure / Illustrazioni rilevatori usura / Figuras avisador de desgaste /  
Rysunki styki ostrzegawcze / Zobrazení kontaktů indikátoru opotřebení

BAV1020			OE - #
  	<p><b>OPEL</b>            SIGNUM / Vauxhall Signum (03-08)            VECTRA C (F68,F69)/Vau. Vectra MK II (02-08)            VECTRA C Caravan (F35) / Vau. MK II (03-08)</p>	<p>1x 1x 1x</p>	<p>62 38 230 24427919</p>
BAV1021			OE - #
  	<p><b>BMW</b>            3er Reihe/E46 (98-06)</p>	<p>1x</p>	<p>34 35 6 751 311</p>
BAV1022			OE - #
  	<p><b>BMW</b>            7er Reihe/E65/66 (02-08)</p>	<p>1x</p>	<p>34 35 6 755 266 34 35 6 778 037</p>









# Abbildungen Warnkontakte

Illustrations témoins d'usure / Illustrazioni rilevatori usura / Figuras avisador de desgaste /  
Rysunki styki ostrzegawcze / Zobrazení kontaktů indikátoru opotřebení

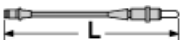
BAV1023			OE - #	
   101 mm	<b>MERCEDES BENZ</b> C-Klasse (CL203) Sportcoupe (01-08) C-Klasse (S203) Kombi (01-07) CLK-Klasse (A209) Cabrio (03-09) CLK-Klasse (A209) Cabrio (03-09) CLK-Klasse (C209) Coupe (02-09) CLK-Klasse (C209) Coupe (02-09) CLS-Klasse (C219) Coupe (04-10) CLS-Klasse (C219) Coupe (04-10) E-Klasse (S211) Kombi (03-09) E-Klasse (S211) Kombi (03-09) E-Klasse (W211) Limousine (02-09) E-Klasse (W211) Limousine (02-09) S-Klasse (W220) (98-06) S-Klasse (W220) (98-06) SLK-Klasse (R171) (04-11) SL-Klasse (R230) (01-) SL-Klasse (R230) (01-)	1x 2x 1x 1x 1x 1x 1x 1x 1x 1x 1x 1x 1x 1x 1x 1x	211 540 07 17	
	BAV1024			OE - #
	   114 mm	<b>MERCEDES BENZ</b> M-Klasse (W163) (98-05)	2x	163 540 15 17 163 540 17 17

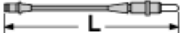











# Abbildungen Warnkontakte

Illustrations témoins d'usure / Illustrazioni rilevatori usura / Figuras avisador de desgaste /  
Rysunki styki ostrzegawcze / Zobrazení kontaktů indikátoru opotřebení

BAV1025				OE - #
   672 mm	<b>BMW</b>			
	5er Reihe/E60 Limousine (03-10)	1x		34 35 6 768 595
	5er Reihe/E61 Touring (04-10)	1x		34 35 6 789 492
	6er Reihe/E63 Coupe (04-11)	1x		
	6er Reihe/E64 Cabrio (04-11)	1x		
BAV1026				OE - #
   167 mm	<b>MERCEDES BENZ</b>			
	V-Klasse (BM638) (96-03)	2x		901 540 02 17
	VITO (BM638) (96-03)	2x		901 540 03 17
	Transporter (BM 901/902) SPRINTER (95-06)	2x		
	Transporter (BM 903/904) SPRINTER (95-06)	2x	2x	
	Transporter (BM 905) SPRINTER (01-06)	2x		
	<b>VOLKSWAGEN</b>			
LT/- 4x4 (96-06)	2x			
BAV1027				OE - #
   685 mm	<b>OPEL</b>			
	ASTRA F / Vauxhall Astra MKIII (91-01)	2x		12 38 984
	CALIBRA / Vauxhall Calibra (89-97)	2x		90425491
	VECTRA A / Vauxhall Cavalier (89-95)	2x		

# Abbildungen Warnkontakte







Illustrations témoins d'usure / Illustrazioni rilevatori usura / Figuras avisador de desgaste /  
Rysunki styki ostrzegawcze / Zobrazení kontaktů indikátoru opotřebení

BAV1028			OE - #
   660 mm	<p><b>OPEL</b></p> <p>ASTRA F / Vauxhall Astra MKIII (91-01)</p> <p>CALIBRA / Vauxhall Calibra (89-97)</p> <p>VECTRA A / Vauxhall Cavalier (89-95)</p>	<p>2x</p> <p>2x</p> <p>2x</p>	<p>12 38 348</p> <p>90335784</p>
BAV1029			OE - #
   660 mm	<p><b>OPEL</b></p> <p>OMEGAA / Vauxhall Carlton (87-93)</p>	<p>2x</p>	<p>12 38 403</p> <p>90305792</p>
BAV1030			OE - #
   660 mm	<p><b>OPEL</b></p> <p>VECTRA B / Vauxhall Vectra (96-02)</p>	<p>2x</p>	<p>62 38 389</p> <p>90497052</p>
BAV1031			OE - #
   810 mm	<p><b>BMW</b></p> <p>3er Reihe/E36 (91-00)</p> <p>Z3 (95-02)</p>	<p>1x</p> <p>1x</p>	<p>34 35 2 227 385</p>

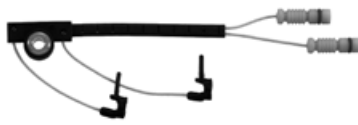



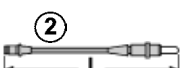

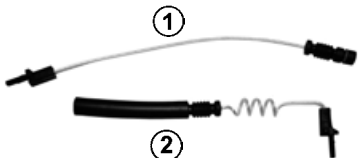
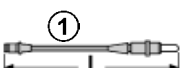
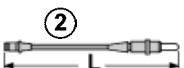





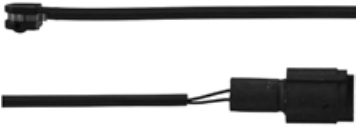





# Abbildungen Warnkontakte

Illustrations témoins d'usure / Illustrazioni rilevatori usura / Figuras avisador de desgaste /  
Rysunki styki ostrzegawcze / Zobrazení kontaktů indikátoru opotřebení

BAV1032			OE - #
   260 mm	<b>MERCEDES BENZ</b> G-Klasse (W460) (79-93) G-Klasse (W461) (90-) G-Klasse (W463) (90-) G-Klasse (W463) Cabrio (90-)	2x 2x 2x 2x	460 540 06 17
BAV1033			OE - #
   239 mm  180 mm	<b>MERCEDES BENZ</b> Transporter (BM 668) 609 D Transporter (BM 669) 709 D/711 D Transporter (BM 670) 809 D-814 D Transporter (BM 905) SPRINTER (01-06) Transporter VARIO (96-)	2x 2x 2x 2x 2x	669 540 04 17
BAV1034			OE - #
   199 mm  144 mm	<b>MERCEDES BENZ</b> Transporter (BM 905) SPRINTER (01-06)	2x	669 540 07 17 669 540 08 17 669 540 09 17









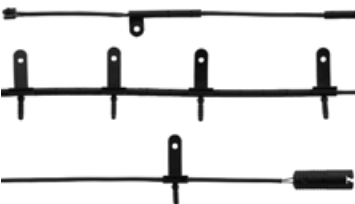

# Abbildungen Warnkontakte

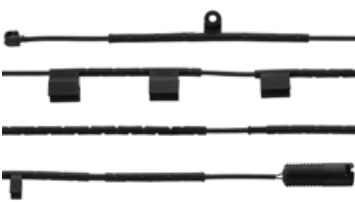
Illustrations témoins d'usure / Illustrazioni rilevatori usura / Figuras avisador de desgaste /  
Rysunki styki ostrzegawcze / Zobrazení kontaktů indikátoru opotřebení

BAV1035				OE - #	
           165 mm	<b>BMW</b> 3er Reihe/E21 (75-83) 5er Reihe/E12 (72-81) 5er Reihe/E28 (81-87) 6er Reihe/E24 (76-89) 7er Reihe/E23 (77-86)	1x 1x 1x 1x 1x 1x 1x 1x 1x	34 21 2 225 229 34 35 1 179 821		
	BAV1036				OE - #
	     570 mm	<b>BMW</b> 7er Reihe/E38 (93-01)	1x	34 35 1 182 064	
	BAV1037				OE - #
	      845 mm	<b>BMW</b> 7er Reihe/E65/66 (02-08)	1x	34 35 6 755 267 34 35 6 778 038	













# Abbildungen Warnkontakte

Illustrations témoins d'usure / Illustrazioni rilevatori usura / Figuras avisador de desgaste /  
Rysunki styki ostrzegawcze / Zobrazení kontaktů indikátoru opotřebení

BAV1038			OE - #
   885 mm	<b>MINI</b> R50/R53 (00-06) R52 Cabrio (04-08)	1x 1x	34 35 6 761 447
BAV1039			OE - #
   1095 mm	<b>MINI</b> R50/R53 (00-06) R52 Cabrio (04-08)	1x 1x	34 35 6 761 448
BAV1040			OE - #
   678 mm	<b>BMW</b> 5er Reihe/E60 Limousine (03-10) 6er Reihe/E63 Coupe (04-11) 6er Reihe/E64 Cabrio (04-11)	1x 1x 1x	34 35 6 768 596 34 35 6 789 493
BAV1041			OE - #
   885 mm	<b>BMW</b> 5er Reihe/E61 Touring (04-10)	1x	34 35 6 789 494 34 35 6 768 597

# Abbildungen Warnkontakte

Illustrations témoins d'usure / Illustrazioni rilevatori usura / Figuras avisador de desgaste /  
Rysunki styki ostrzegawcze / Zobrazení kontaktů indikátoru opotřebení

BAV1042			OE - #
  644 mm	<b>BMW</b> 1er Reihe/E81/E87 Limousine (04-11) 1er Reihe/E82 Coupe (07-) 1er Reihe/E88 Cabrio (08-) 3er Reihe/E90 Limousine (05-) 3er Reihe/E91 Touring (05-) 3er Reihe/E92 Coupe (06-) 3er Reihe/E93 Cabrio (07-)	1x 1x 1x 1x 1x 1x 1x	34 35 6 789 439
BAV1043			OE - #
  1096 mm	<b>BMW</b> 1er Reihe/E81/E87 Limousine (04-11) 1er Reihe/E82 Coupe (07-) 1er Reihe/E88 Cabrio (08-) 3er Reihe/E90 Limousine (05-) 3er Reihe/E91 Touring (05-) 3er Reihe/E92 Coupe (06-) 3er Reihe/E93 Cabrio (07-)	1x 1x 1x 1x 1x 1x 1x	34 35 6 789 445
BAV1044			OE - #
  805 mm	<b>MINI</b> R55 Clubman (07-) R56 (06-) R57 Cabrio (09-)	1x 1x 1x	34 35 6 783 230
BAV1045			OE - #
  1125 mm	<b>MINI</b> R55 Clubman (07-) R56 (06-) R57 Cabrio (09-)	1x 1x 1x	34 35 6 773 018 34 35 6 789 330

# Abbildungen Warnkontakte

Illustrations témoins d'usure / Illustrazioni rilevatori usura / Figuras avisador de desgaste /  
Rysunki styki ostrzegawcze / Zobrazení kontaktů indikátoru opotřebení

**BAV1046**



**OE - #**





95 mm

## MERCEDES BENZ

A-Klasse (W169 ) (04-) / B-Klasse (W245) (05-11)	1x	211 540 17 17
C-Klasse (C204) Coupe (11-)	2x 2x	
C-Klasse (CL203) Sportcoupe (01-08)	2x 1x	
C-Klasse (CLC203) Coupe (08-10)	1x 1x	
C-Klasse (S203) Kombi (01-07)	2x 2x	
C-Klasse (S204) Kombi (07-)	1x 1x	
C-Klasse (W203) Limousine (00-07)	2x 2x	
C-Klasse (W204) Limousine (07-)	1x 1x	
CLK-Klasse (C209) Coupe (02-09)	2x 1x	
CLK-Klasse (A209) Cabrio (03-09)	2x 1x	
CL-Klasse (C215) Coupe (99-06)	2x 1x	
CL-Klasse (C216) Coupe (06-)	1x 1x	
CLS-Klasse (C218) Coupe (10-)	1x 1x	
CLS-Klasse (C219) Coupe (04-10)	1x 1x	
E-Klasse (A207) Cabrio (10-)	1x 1x	
E-Klasse (C207) Coupe (09-)	1x 1x	
E-Klasse (S211) Kombi (03-09)	2x 1x	
E-Klasse (S212) Kombi (09-)	2x 1x	
E-Klasse (W211) Limousine (02-09)	2x 1x	
E-Klasse (W212) Limousine (09-)	1x 1x	
GLK-Klasse (X204) (08-)	1x 1x	
S-Klasse (W220) (98-06)	2x 1x	
S-Klasse (W221) (06-)	1x 1x	
SLK-Klasse (R171) (04-11)	2x 1x	
SLK-Klasse (R172) (11-)	1x 1x	
SL-Klasse (R230) (01-)	2x 1x	
SLR-Klasse (C199) Coupe (04-09)	2x	
VANEO (BM414) (02-05)	1x	



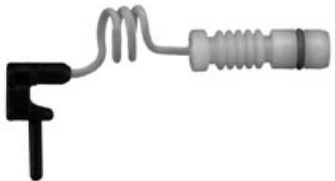
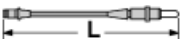

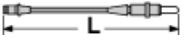







# Abbildungen Warnkontakte

Illustrations témoins d'usure / Illustrazioni rilevatori usura / Figuras avisador de desgaste /  
Rysunki styki ostrzegawcze / Zobrazení kontaktů indikátoru opotřebení

BAV1047				OE - #
   <p>72 mm (147)mm</p>	<b>MERCEDES BENZ</b> M-Klasse (W163) (98-05)	2x		202 540 07 17
BAV1048				OE - #
   <p>95 mm</p>	<b>MERCEDES BENZ</b> VIANO (BM639) (03-) VITO (BM639) (03-) Transporter (BM 906) SPRINTER (06-) <b>VOLKSWAGEN</b> CRAFTER (06-)	2x 2x 2x 2x 2x 2x		639 540 14 17 639 540 15 17 2E0 906 206 G













# Abbildungen Warnkontakte

Illustrations témoins d'usure / Illustrazioni rilevatori usura / Figuras avisador de desgaste /  
Rysunki styki ostrzegawcze / Zobrazení kontaktů indikátoru opotřebení

BAV1049			OE - #
   730 mm	<b>OPEL</b> OMEGA B / Vauxhall Omega (94-03)	2x	62 38 322 90495145
BAV1050			OE - #
   505 mm	<b>PORSCHE</b> 911 (996) (97-05) 911 TARGA (996) (01-05) 911 CABRIO (996) (98-05) 911 COUPE (997) (04-) 911 CABRIO (997) (05-) BOXSTER (986) (96-04)	2x 2x 2x 2x 2x 2x 2x 2x 2x	996 612 365 00
BAV1051			OE - #
   505 mm	<b>PORSCHE</b> BOXSTER (986) (96-04) BOXSTER (987) (05-) CAYMAN (987C) (05-)	2x 2x 2x	986 612 365 00
BAV1052			OE - #
   420 mm	<b>AUDI</b> Q7 (06-) <b>PORSCHE</b> CAYENNE I (03-10) <b>VOLKSWAGEN</b> TOUAREG I (03-10)	2x 2x 2x	7L0 907 637 955 612 365 00 7L0 907 637

# Abbildungen Warnkontakte

Illustrations témoins d'usure / Illustrazioni rilevatori usura / Figuras avisador de desgaste /  
Rysunki styki ostrzegawcze / Zobrazení kontaktů indikátoru opotřebení

BAV1053				OE - #
   255 mm	<b>AUDI</b> Q7 (06-)	2x		7L0 907 637 C
	<b>PORSCHE</b> CAYENNE I (03-10)	2x		955 612 365 20 955 612 365 30
	<b>VOLKSWAGEN</b> TOUAREG I (03-10)	2x		7L0 907 637 C
BAV1054				OE - #
   300 mm	<b>IVECO</b> DAILY I / GRINTA DAILY II (99-06)	2x	2x	1908407
			2x	
BAV1055				OE - #
   1178 mm	<b>LAND ROVER</b> DISCOVERY III (04-)	1x		SEM000024
	RANGE ROVER SPORT (05-)	1x		
BAV1056				OE - #
   1184 mm	<b>LAND ROVER</b> DISCOVERY III (04-)	1x		SOE000025
	RANGE ROVER SPORT (05-)	1x		



# Abbildungen Trommelbremsbacken

Illustrations mâchoires de frein à tambour / Illustrazioni ganasce freno / Figuras Calços de travão de tambor / Rysunki szczęk hamulca bębnowego / Zobrazení čelistí bubnových brzd

**BAE5001**

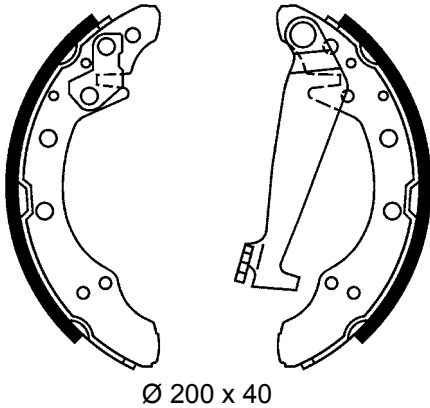

Ø 200 x 40

**BAE5002**

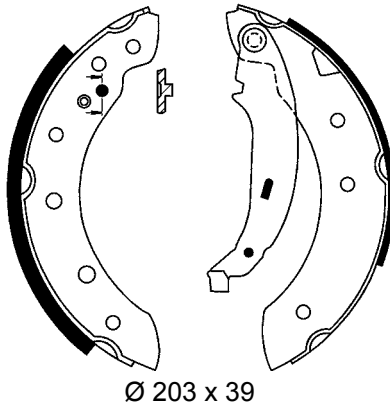

Ø 203 x 39

**BAE5003**

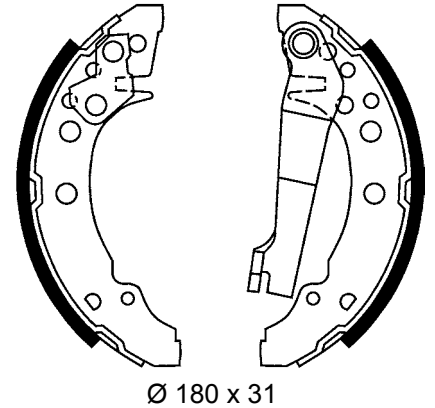

Ø 180 x 31

**BAE5004**

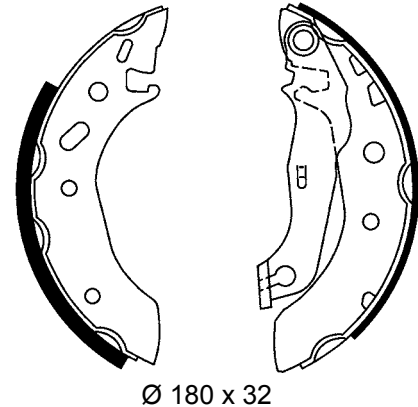

Ø 180 x 32

**BAE5005**

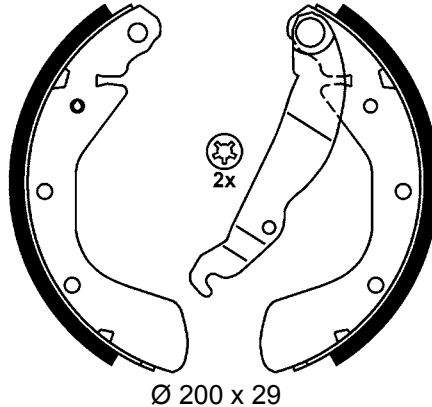

Ø 200 x 29

**BAE5006**

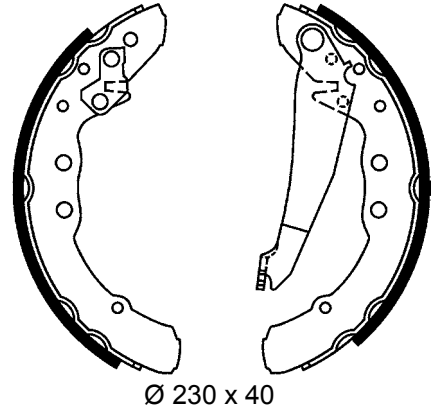

Ø 230 x 40

**BAE5007**

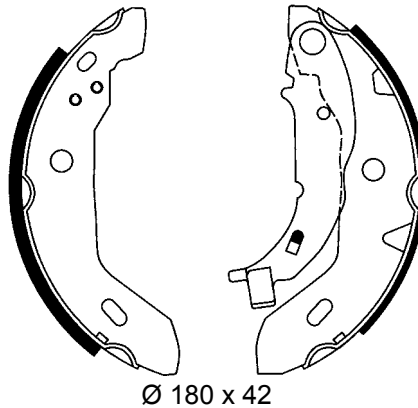

Ø 180 x 42

**BAE5008**

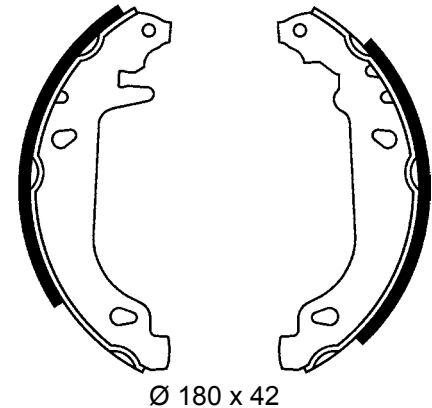

Ø 180 x 42

**BAE5009**

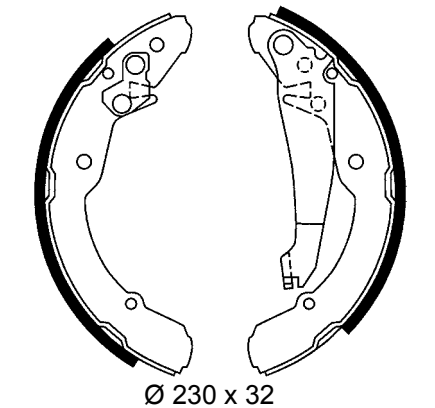

Ø 230 x 32

**BAE5010**

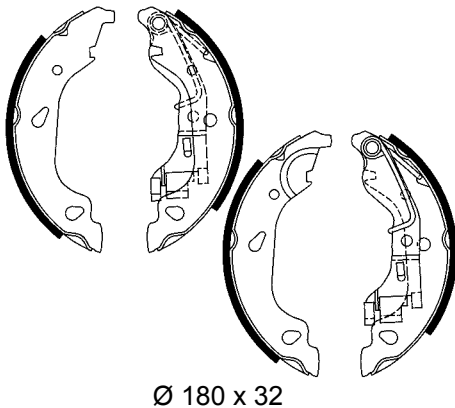

Ø 180 x 32

**BAE5011**

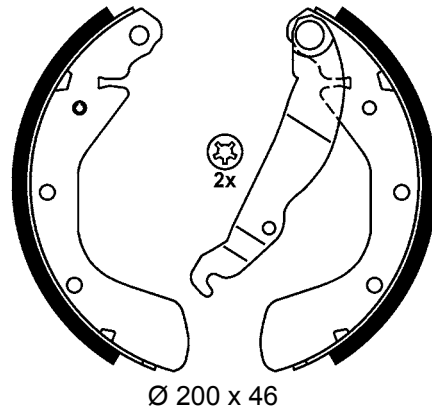

Ø 200 x 46

**BAE5012**

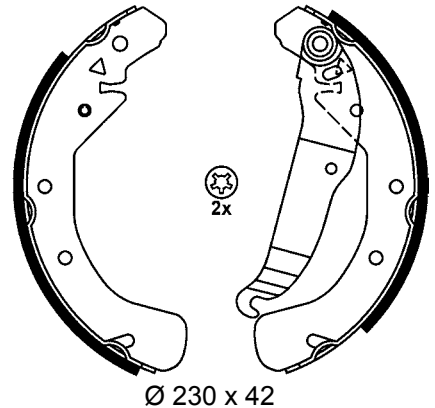

Ø 230 x 42

# Abbildungen Trommelbremsbacken

Illustrations mâchoires de frein à tambour / Illustrazioni ganasce freno / Figuras Calços de travão de tambor /  
Rysunki szczęk hamulca bębnowego / Zobrazení čelistí bubnových brzd

**BAE5013**

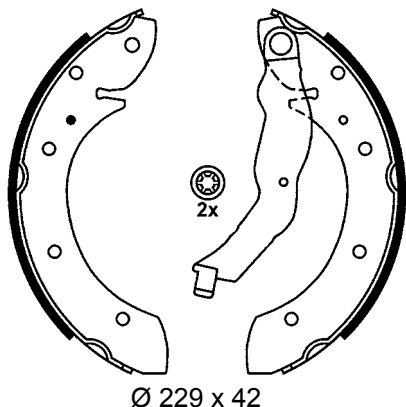

Ø 229 x 42

**BAE5014**

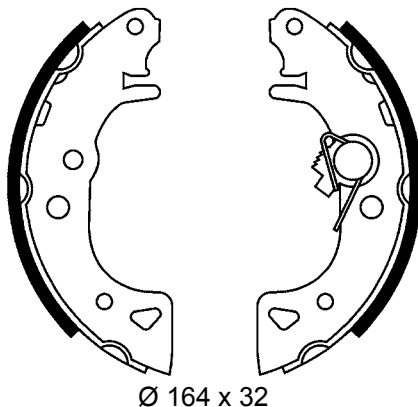

Ø 164 x 32

**BAE5015**

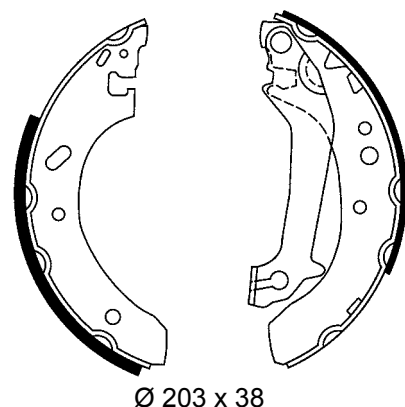

Ø 203 x 38

**BAE5016**

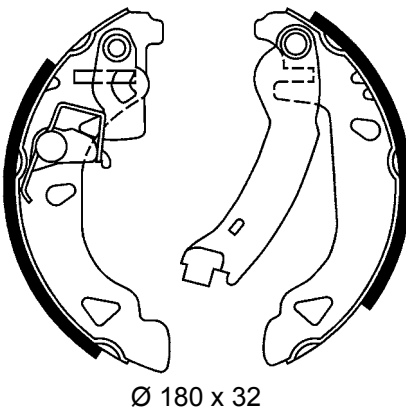

Ø 180 x 32

**BAE5017**

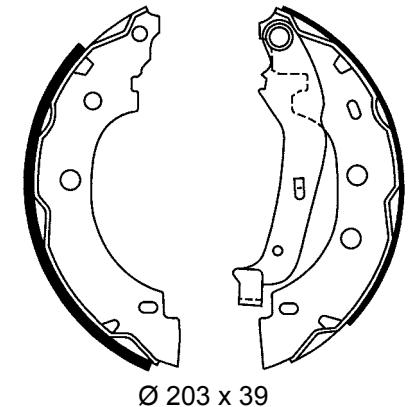

Ø 203 x 39

**BAE5018**

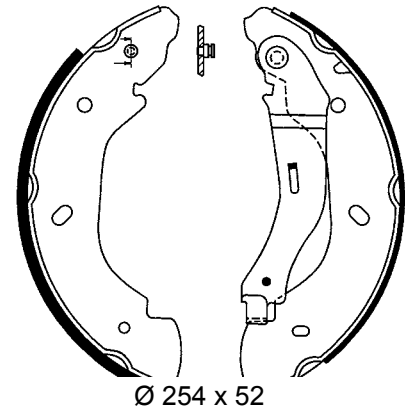

Ø 254 x 52

**BAE5019**

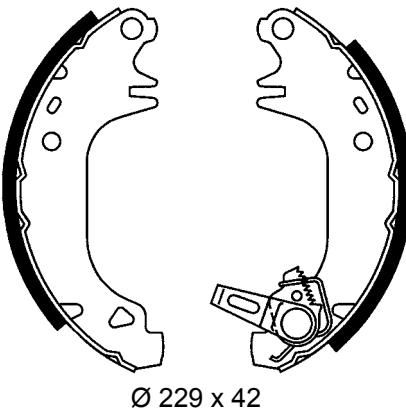

Ø 229 x 42

**BAE5020**

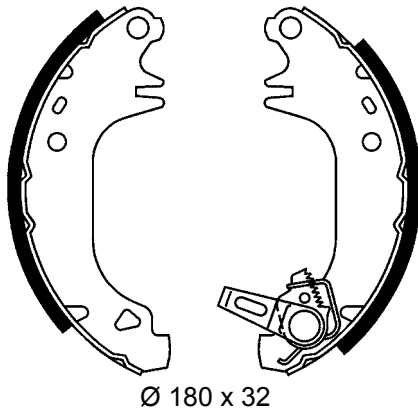

Ø 180 x 32

**BAE5021**

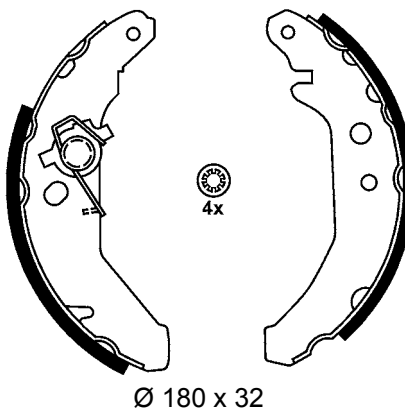

Ø 180 x 32

**BAE5022**

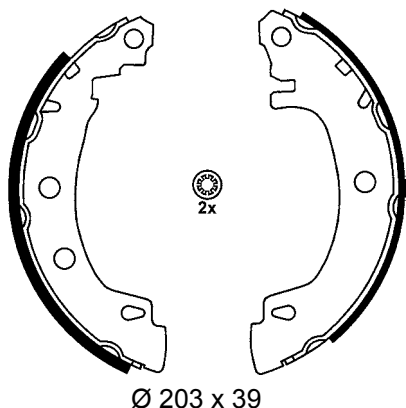

Ø 203 x 39

**BAE5023**

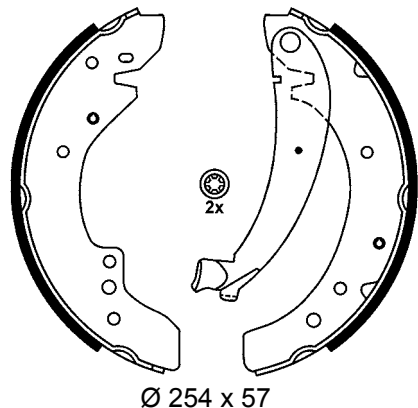

Ø 254 x 57

**BAE5024**

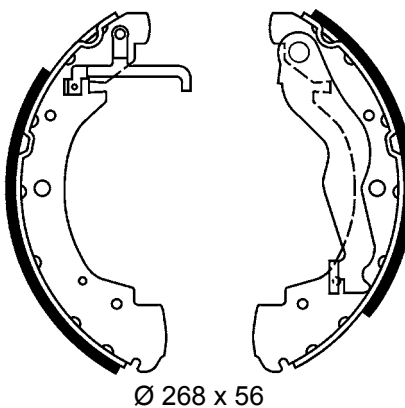

Ø 268 x 56

# Abbildungen Trommelbremsbacken

Illustrations mâchoires de frein à tambour / Illustrazioni ganasce freno / Figuras Calços de travão de tambor / Rysunki szczęk hamulca bębnowego / Zobrazení čelistí bubnových brzd

**BAE5025**

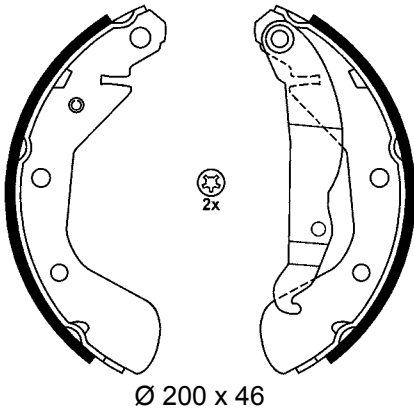

Ø 200 x 46

**BAE5026**

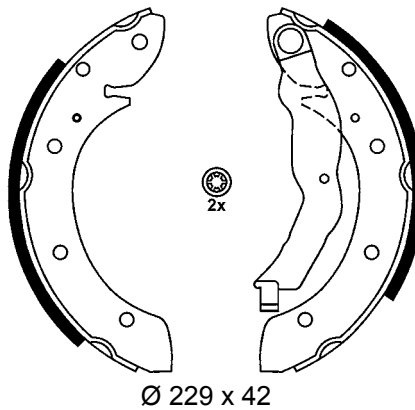

Ø 229 x 42

**BAE5027**

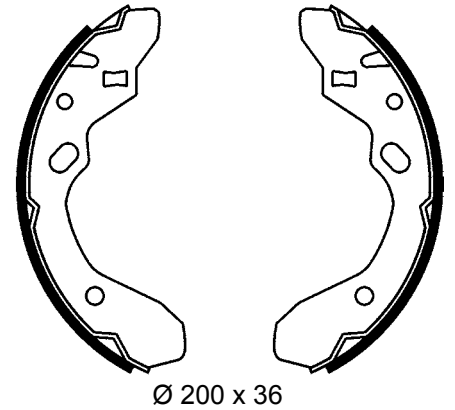

Ø 200 x 36

**BAE5028**

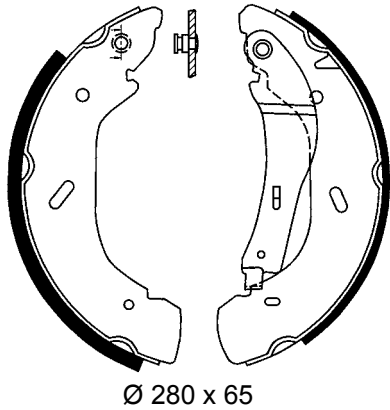

Ø 280 x 65

**BAE5029**

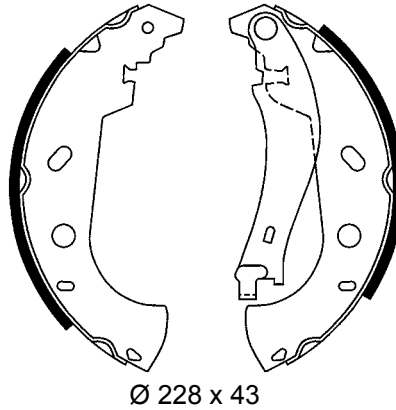

Ø 228 x 43

**BAE5030**

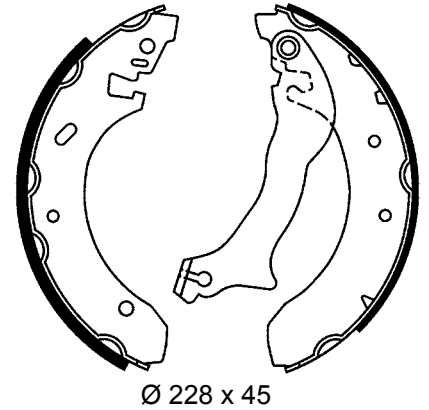

Ø 228 x 45

**BAE5031**

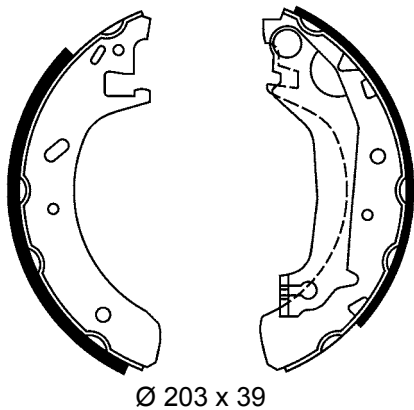

Ø 203 x 39

**BAE5032**

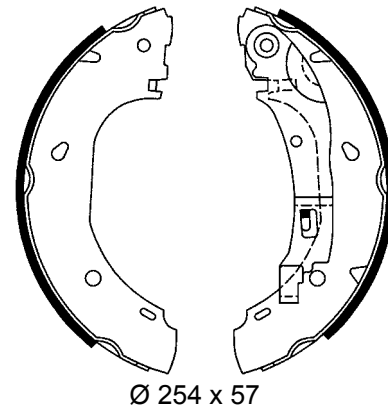

Ø 254 x 57

**BAE5033**

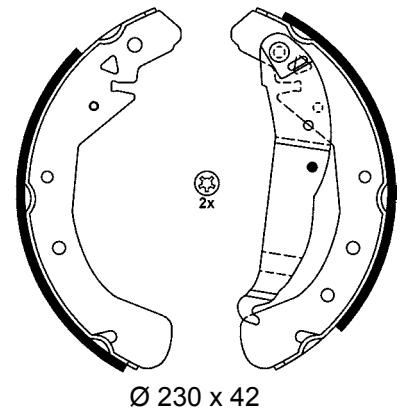

Ø 230 x 42

**BAE5034**

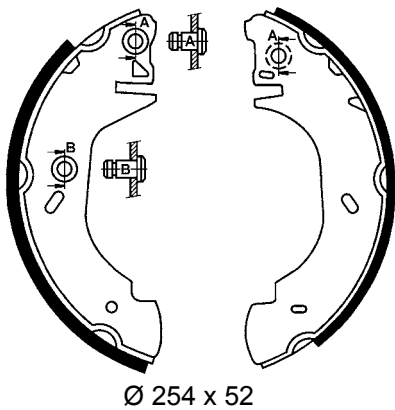

Ø 254 x 52

**BAE5035**

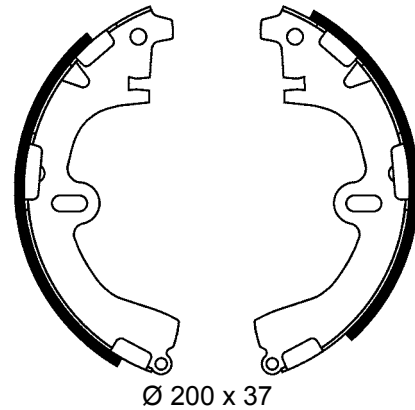

Ø 200 x 37

**BAE5036**

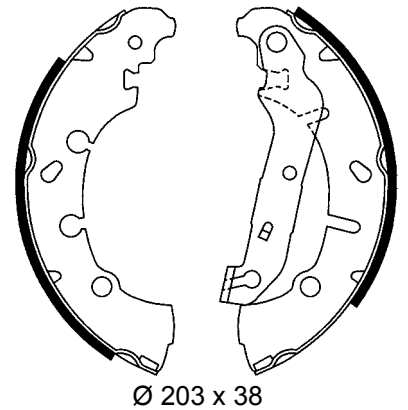

Ø 203 x 38

# Abbildungen Trommelbremsbacken

Illustrations mâchoires de frein à tambour / Illustrazioni ganasce freno / Figuras Calços de travão de tambor / Rysunki szczęk hamulca bębnowego / Zobrazení čelistí bubnových brzd

**BAE5037**

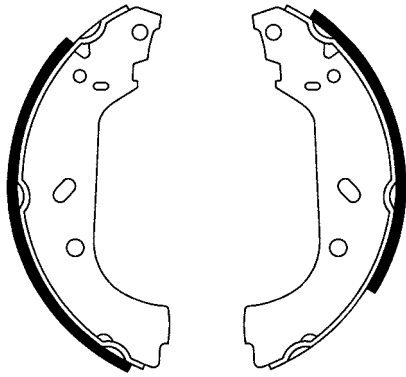

Ø 255 x 61

**BAE5038**

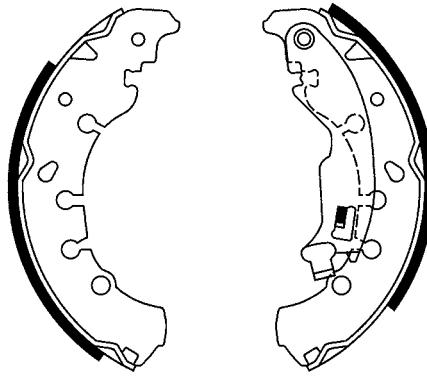

Ø 203 x 38

**BAE5039**

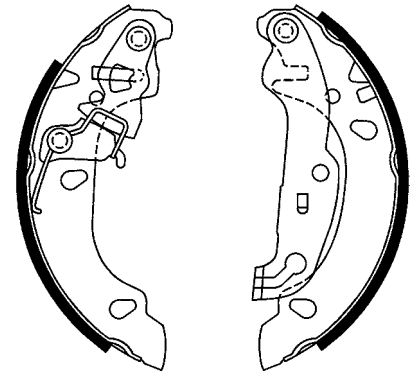

Ø 180 x 32

**BAE5040**

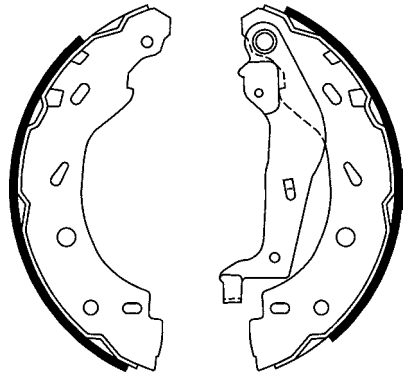

Ø 203 x 32

**BAE5041**

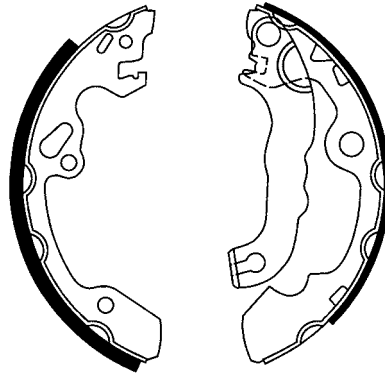

Ø 203 x 38

**BAE5042**

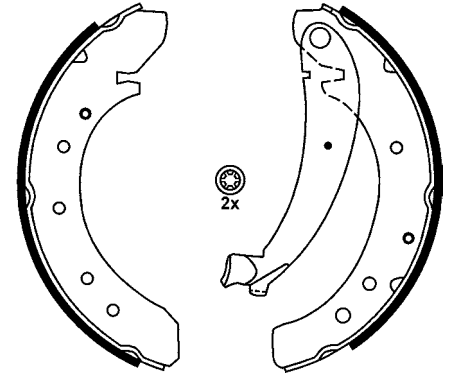

Ø 254 x 57

# Abmessungen Bremsscheiben

Dimensions disques de frein / Misura dischi freno /

Dimensões dos discos dos travões / Wymiary tarcz hamulcowych /

Rozměry brzdových kotoučů

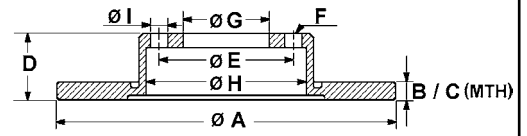

HC hochgekohlt - high carbon - ad alto tenore di carbonio - à haute teneur en carbone - altamente carbonizado  
L legiert - alloyed - alligato/legato - alié - aleado  
V ventiliert - ventilated - ventilato - ventilé - ventilado

	HC	L	V	A	B	C	D	E	F	G	H	I	OE - #	
BAR08104				238,0	8,2	7,0	41,1	100,0	4	61,0	129,5	12,8	RENAULT	77 01 204 285
BAR08106				247,0	8,0	6,0	25,3	108,0	4	71,0	133,2	13,0	CITROEN	95 661 749
													PEUGEOT	4246 G6
BAR08107				238,0	8,0	6,0	29,0	98,0	3	57,0	124,5	13,0	CITROEN	95 027 199
													PEUGEOT	95 661 810
													PEUGEOT	4246 G0
BAR08111				258,0	8,0	7,0	55,3	112,0	5	67,0	164,0	13,2	MERCEDES BENZ	168 423 02 12
BAR09114				278,0	9,0	7,3	55,5	112,0	5	67,0	164,0	15,0	CHRYSLER	5098 066AA
													MERCEDES BENZ	203 423 01 12
													MERCEDES BENZ	210 423 01 12
													MERCEDES BENZ	210 423 04 12
													MERCEDES BENZ	210 423 09 12
BAR09118				258,0	9,0	7,3	55,3	112,0	5	67,0	164,0	15,0	MERCEDES BENZ	201 423 12 12
BAR09120				258,0	9,0	7,3	55,3	112,0	5	67,0	164,0	13,0	MERCEDES BENZ	202 423 00 12
BAR09122				224,0	9,0	7,0	57,5	108,0	4	71,1	132,7	13,0	CITROEN	95 667 811
BAR09123				232,0	8,9	7,0	39,4	100,0	5	65,0	125,0	15,8	AUDI/SEAT/SKODA/VW	1J0 615 601
													SEAT/VW	1J0 615 601 C
BAR09124				232,0	8,9	7,0	39,4	100,0	4	65,0	125,0	13,8	SEAT/VW	6N0 615 601 A
													SEAT/VW	6N0 615 601 B
BAR09133				239,0	8,9	7,0	33,4	100,0	5	65,0	132,5	15,8	AUDI/VW/SKODA	1J0 615 601 D
BAR09136	HC			279,8	9,0	8,0	38,0	112,0	3	58,0	153,8	12,6	SMART	000 4341 V002 000000
BAR09137				247,0	9,0	8,0	35,0	108,0	4	71,1	133,0	13,0	CITROEN	4246 X8
													PEUGEOT	4259 53
													PEUGEOT	4246 W9
													PEUGEOT	4259 52
													PEUGEOT	4249 90
BAR09138				258,0	9,0	8,0	55,5	100,0	4	55,0	172,0	14,5	TOYOTA	42431-02070
BAR09139				269,0	9,0	8,0	56,0	100,0	4	55,0	173,0	14,5	TOYOTA	42431-12250
													TOYOTA	42431-52050
													TOYOTA	42431-47020
BAR10111				226,0	10,0	8,0	71,2	100,0	4	39,9	121,4	M12x1,5	SEAT/VW	357 615 601
													VOLKSWAGEN	6N0 615 601
BAR10115				253,0	10,2	8,9	33,0	108,0	4	63,5	155,0	13,7	FORD	1514237
													FORD	4083484
													FORD	5022666
													FORD	5030658
BAR10151				239,0	9,9	8,0	38,6	100,0	4	65,0	124,5	13,8	AUDI/SEAT/VW	811 615 301
BAR10152				236,0	10,0	7,0	41,0	100,0	4/6	60,0	123,0	14,3	OPEL/AUXHALL	5 69 028/90008003
BAR10178				245,0	9,9	8,0	59,2	108,0	4	68,0	136,0	15,3	AUDI	443 615 601
BAR10185				279,0	10,0	8,3	71,7	112,0	5	67,0	160,0	15,0	MERCEDES BENZ	126 423 00 12
BAR10187				247,0	10,0	8,0	34,0	108,0	4	66,0	133,2	13,0	CITROEN	95 661 748
													PEUGEOT	4246 A5
													PEUGEOT	4249 95
BAR10189				281,2	9,6	8,4	73,2	108,0	5	68,0	160,0	16,5	VOLVO	270736
BAR10191				270,0	9,9	8,0	67,0	110,0	5	65,5	160,0	14,3	OPEL/AUXHALL	5 69 101/90272328
BAR10196				239,4	10,0	8,0	42,9	108,0	4	63,5	136,0	13,7	FORD	5022652
													FORD	5022653
BAR10201				245,0	9,9	8,0	63,9	112,0	5	68,0	136,0	15,5	AUDI/SKODAVW	4A0 615 601 A
BAR10202	HC			280,0	10,0	8,4	60,1	120,0	5	75,0	161,0	14,8	BMW	34 21 1 165 457
BAR10203				226,0	10,0	8,0	71,2	100,0	5	39,9	50,3	M14x1,5	SEAT/VW	357 615 601 B
BAR10204				260,0	10,0	8,0	69,2	100,0	4	57,0	160,0	14,2	OPEL/AUXHALL	5 69 206/90421872
BAR10205				270,0	9,9	8,0	77,0	100,0	4	57,0	160,0	14,2	OPEL/AUXHALL	5 69 102/90297932
BAR10210				245,0	10,0	8,0	83,6	112,0	5	45,2	136,0	M14x1,5	AUDI	8D0 615 601 B
BAR10211	HC			272,0	10,0	8,4	77,9	120,0	5	75,0	160,8	14,7	BMW	34 21 6 758 552
BAR10215				258,0	10,0	9,0	45,0	114,3	4	68,0	154,0	12,8	NISSAN	43206-99J01
BAR10217				290,0	10,0	8,3	55,5	112,0	5	67,0	164,0	13,3	MERCEDES BENZ	210 423 06 12
													MERCEDES BENZ	210 423 10 12
BAR10219				265,0	10,5	9,5	44,3	100,0	4	66,0	149,6	13,5	RENAULT	77 01 205 844
BAR10223				268,0	9,9	8,0	45,7	112,0	5	68,2	154,5	16,7	FORD	1001094
													FORD	1045995
													SEAT/VW	7M0 615 601 C
BAR10224				245,0	10,0	8,0	47,8	112,0	5	68,0	135,5	15,4	AUDI/VW	8D0 615 601 A
													AUDI/VW	8E0 615 601 A
BAR10225				270,0	10,0	8,0	69,2	100,0	4	57,0	160,0	14,2	OPEL/AUXHALL	5 69 209/90512909
BAR10226				286,0	10,0	8,0	69,2	110,0	5	65,5	160,0	14,4	OPEL/AUXHALL	5 69 210/90512910
													SAAB	4565693
													SAAB	5391578

# Abmessungen Bremsscheiben

Dimensions disques de frein / Misura dischi freno /

Dimensões dos discos dos travões / Wymiary tarcz hamulcowych /

Rozměry brzdových kotoučů

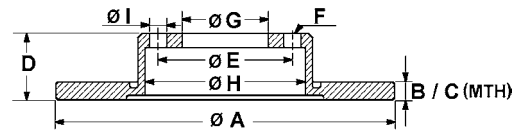

HC hochgekohlt - high carbon - ad alto tenore di carbonio - à haute teneur en carbone - altamente carbonizado

L legiert - alloyed - alligato/legato - alié - aleado

V ventiliert - ventilated - ventilato - ventilé - ventilado

	HC	L	V	A	B	C	D	E	F	G	H	I	OE - #
BAR10227	HC			298,0	10,0	8,4	61,0	120,0	5	75,0	185,0	14,5	BMW 34 21 1 163 835 34 21 6 767 049
BAR10228	HC	L		280,0	10,0	8,0	65,2	112,0	5	67,0	178,0	15,0	MERCEDES BENZ 638 423 01 12
BAR10229				260,0	10,0	8,4	41,0	114,3	4	90,0	154,0	12,6	MITSUBISHI MB699288 MR249356 MR913846 30872940
BAR10230				290,5	10,0	8,0	60,0	108,0	4	71,0	185,0	13,0	VOLVO PEUGEOT 4246 L7 4246 T6 4246 T7
BAR10232		L		239,0	10,0	8,0	33,9	100,0	4	65,0	124,0	13,6	SEAT/VW 6N0 615 301
BAR10250				264,0	9,9	8,0	42,0	110,0	5	65,5	144,8	14,3	OPEL/VAUXHALL 5 69 109/9117772
BAR10251				240,0	9,9	8,0	42,0	100,0	4	57,0	140,8	14,3	OPEL/VAUXHALL 5 69 111/9196587
BAR10258				245,0	10,0	8,0	53,8	112,0	5	68,0	135,5	15,3	AUDI 4B0 615 601
BAR10259				255,0	10,0	8,0	53,8	112,0	5	68,0	144,5	15,3	AUDI 4B0 615 601 A
BAR10260				255,0	10,0	8,0	47,8	112,0	5	68,0	144,5	15,3	AUDI 4B0 615 601 B
BAR10261				245,0	10,0	8,0	39,8	112,0	5/9	68,0	135,5	15,3	AUDI 8E0 615 601 B 8E0 615 601 P
BAR10273	HC			272,0	10,0	8,4	83,0	120,0	5	75,0	161,0	14,5	BMW 34 21 1 164 399
BAR10278				300,0	10,0	8,3	68,3	112,0	5	67,0	180,0	15,3	MERCEDES BENZ 211 423 07 12
BAR10280				296,0	10,0	8,0	57,7	112,0	5	67,0	186,0	15,0	MERCEDES BENZ 639 423 01 12
BAR10285				277,5	10,0	9,0	45,0	114,3	5	68,0	154,3	12,6	NISSAN 43206-4U101 43206-4U103
BAR10304				250,0	10,0	8,0	38,6	114,3	4	69,0	147,0	12,6	MITSUBISHI SMART 4605A076 454 420 00 72
BAR11115				252,5	10,0	9,0	65,0	98,0	4	68,0	118,0	13,3	LADA 2101-3103002 2101-3501070
BAR11119				240,0	11,0	9,2	40,0	98,0	4	59,0	123,0	13,3	ALFA/FIAT/LANCIA 7663465 7685656 46403960 51876438 60811879 71769481 FORD 1541804 9S51 1125-CA
BAR11137				262,0	10,9	9,0	45,5	112,0	5	67,0	142,5	15,0	MERCEDES BENZ 201 421 12 12
BAR11151				265,0	10,5	9,5	54,3	108,0	5	66,0	149,6	15,7	RENAULT 60 25 304 079 60 25 370 406
BAR11152				240,0	10,9	8,0	41,2	100,0	4/6	60,0	126,0	14,3	OPEL/VAUXHALL 5 69 020/9195981
BAR12106				239,0	12,0	10,0	35,1	100,0	4	65,0	124,2	13,8	AUDI/SEAT/VW 321 615 301 AUDI/VW 175 615 301
BAR12116				238,0	12,0	10,5	41,0	100,0	4	61,0	129,5	12,8	DACIA 77 01 204 282 RENAULT 77 01 204 282 77 01 204 282
BAR12117		L		284,0	12,0	10,0	43,5	112,0	5	67,0	154,2	15,0	MERCEDES BENZ 124 421 13 12
BAR12124	HC			302,0	12,0	10,4	76,0	120,0	5	79,0	149,0	14,5	BMW 34 11 1 161 693
BAR12125				239,0	12,0	10,8	42,4	98,0	4	58,5	125,0	13,3	LADA 2108-3501070
BAR12126				286,0	11,9	10,4	51,6	120,0	5	79,0	147,7	14,8	BMW 34 11 6 757 750
BAR12127				257,0	12,0	10,2	40,5	98,0	4	59,0	123,0	13,3	ALFA/FIAT/LANCIA 7663466 46820655 51859075 51866265 60808872
BAR12128		L		284,0	12,0	10,0	43,5	112,0	5	67,0	154,2	13,0	MERCEDES BENZ 202 421 02 12
BAR12131				286,0	12,0	10,0	69,4	110,0	5	65,5	160,0	14,3	OPEL/VAUXHALL 5 69 208/90444513
BAR12132	HC			324,0	12,0	10,4	61,0	120,0	5	75,0	180,0	14,5	BMW 34 21 6 757 748
BAR12137				234,0	12,0	10,0	45,3	100,0	4	59,0	129,5	12,6	NISSAN 40206-5F003
BAR12138				280,0	12,0	10,0	40,2	112,0	5	68,2	153,0	16,5	VOLKSWAGEN 701 615 601 A 7D0 615 601 7D0 615 601 B
BAR12141				239,5	12,0	10,0	42,9	108,0	4	63,5	136,0	13,7	FORD 1013581 1019598 1112542 MAZDA 1E03-33-251 1E03-33-251A 1E04-33-251

# Abmessungen Bremsscheiben

Dimensions disques de frein / Misura dischi freno /

Dimensões dos discos dos travões / Wymiary tarcz hamulcowych /

Rozměry brzdových kotoučů

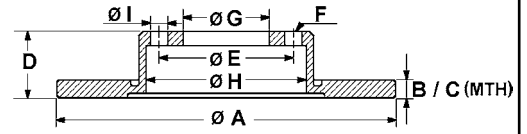

HC hochgekohlt - high carbon - ad alto tenore di carbonio - à haute teneur en carbone - altamente carbonizado  
 L legiert - alloyed - alligato/legato - alié - aleado  
 V ventiliert - ventilated - ventilato - ventilé - ventilado

	HC	L	V	A	B	C	D	E	F	G	H	I	OE - #	
BAR12142	HC	L		258,0	12,0	10,0	96,5	130,0	5	85,0	160,0	15,0	MERCEDES BENZ VOLKSWAGEN	901 423 06 12 901 423 08 12 2D0 615 601 2D0 615 601 C
BAR12144		L		260,0	12,0	10,0	40,5	112,0	5	67,0	145,0	13,0	MERCEDES BENZ	168 421 01 12
BAR12149				290,0	12,0	10,3	56,0	112,0	5	67,0	164,0	13,2	MERCEDES BENZ	210 423 05 12
BAR12154				280,0	12,0	10,0	34,0	108,0	5	63,5	151,0	13,7	FORD JAGUAR	1376138 4176921 4179406 C2S 35271 C2S 42668 C2S 49730
BAR12157				278,0	12,0	10,0	41,5	110,0	5	65,5	144,8	14,3	FIAT OPEL/AUXHALL SAAB	46836489 5 69 115/93171848 9156785 12762290
BAR12158				256,0	12,0	10,0	48,3	112,0	5/9	65,0	140,0	15,3	AUDI/SKODA/VW	1K0 615 601 L 1K0 615 601 AC
BAR12169				282,0	12,0	10,0	48,3	112,0	5/9	65,0	159,0	15,3	AUDI/SKODA/VW	1K0 615 601 M 1K0 615 601 AD
BAR12171				259,0	12,0	10,6	40,9	100,0	4	61,0	130,0	13,5	DACIA RENAULT	60 01 547 683 77 01 208 252 60 01 547 683 77 01 208 252
BAR12184				257,0	12,0	10,0	40,5	100,0	4/6	60,0	127,0	14,3	FIAT OPEL/AUXHALL	51806099 51806103 55700398 55700918 5 69 022/93188916
BAR13137				278,0	12,6	10,6	63,3	112,0	5	80,0	127,5	15,2	MERCEDES BENZ	123 421 00 12
BAR13160				256,0	12,9	11,0	46,2	108,0	4	68,0	135,5	15,5	AUDI	443 615 301
BAR13161				236,0	12,7	10,7	41,0	100,0	4/6	60,0	123,0	14,2	OPEL/AUXHALL	5 69 020/90008005 5 69 030/90008031
BAR13166				256,0	13,0	11,0	56,2	108,0	4	68,0	134,5	15,4	AUDI	895 615 301
BAR13167				260,0	12,6	11,1	35,1	100,0	4	66,0	137,5	14,8	BMW	34 11 6 752 434
BAR13178				256,0	12,9	11,0	39,2	100,0	4	65,0	135,5	13,8	SEAT/VW	357 615 301
BAR13182				236,0	12,8	11,4	45,6	100,0	4	62,0	124,9	13,8	SKODA/VW	6U0 615 301
BAR13184				266,0	13,0	11,0	27,2	108,0	4	66,0	133,0	13,0	CITROEN	4246 R4 4249 82
BAR13185				247,0	13,0	11,0	34,2	108,0	4	66,0	133,2	13,0	PEUGEOT CITROEN PEUGEOT	4246 R2 4246 R9 4246 R8 4249 A5
BAR13194				294,0	13,5	11,5	41,2	112,0	5	68,1	165,0	16,8	FORD SEAT/VW	1140278 7D0 615 601 C
BAR15105	HC			288,0	15,0	13,0	46,2	112,0	5	68,0	134,0	15,3	AUDI	4A0 615 301 B
BAR16100				280,0	16,0	13,0	78,6	112,0	5	88,0	133,5	12,6	MERCEDES BENZ	601 420 02 72 601 421 04 12
BAR16105				256,0	16,1	13,5	64,1	118,0	5	73,0	141,0	15,7	ALFA/FIAT CITROEN PEUGEOT	7531819 60809894 93500520 4246 N5 4246 B4 4249 L1
BAR16110	HC	L		272,0	16,0	14,0	96,7	130,0	5	85,0	160,0	15,0	MERCEDES BENZ VOLKSWAGEN	902 423 03 12 902 423 05 12 2D0 615 601 A 2D0 615 601 D
BAR18105				282,0	18,0	15,0	64,7	112,0	5	68,2	144,0	16,5	VOLKSWAGEN	701 615 301 E
BAR18106	HC		V	239,0	18,0	16,0	34,5	100,0	4	65,0	126,1	14,0	SEAT/VW VOLKSWAGEN	6N0 615 301 C 6N0 615 301 F
BAR18107			V	240,0	18,0	16,0	45,2	100,0	4	61,0	130,0	12,6	NISSAN	40206-58A00 40206-58A01 40206-60Y01
BAR18108				280,0	18,0	15,9	65,5	118,0	5	73,0	141,0	15,8	CITROEN FIAT PEUGEOT	4246 J9 1300500080 4246 J8

# Abmessungen Bremsscheiben

Dimensions disques de frein / Misura dischi freno /  
Dimensões dos discos dos travões / Wymiary tarcz hamulcowych /  
Rozměry brzdových kotoučů

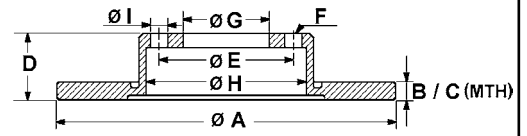

HC hochgekohlt - high carbon - ad alto tenore di carbonio - à haute teneur en carbone - altamente carbonizado  
L legiert - alloyed - alligato/legato - allié - aleado  
V ventiliert - ventilated - ventilato - ventilé - ventilado

	HC	L	V	A	B	C	D	E	F	G	H	I	OE - #	
BAR18111	HC		V	281,7	18,0	15,0	55,3	112,0	5	68,3	145,7	16,7	VOLKSWAGEN	701 615 301 G
BAR18113			V	235,0	18,0	16,0	45,0	100,0	4	55,0	125,0	13,0	MAZDA	NA01-33-25X NA01-33-25XA NA01-33-25XC
BAR18124			V	238,0	18,0	17,0	42,8	100,0	4	55,0	127,0	14,6	TOYOTA	43512-16070 43512-16120
BAR18137	HC		V	238,7	18,0	16,0	34,9	100,0	5	65,0	126,7	15,7	SKODA/VW VOLKSWAGEN	6Q0 615 301 6Q0 615 301 A
BAR19107	HC		V	276,0	19,0	17,4	60,0	120,0	5	75,0	160,8	14,8	BMW	34 21 1 165 211
BAR19108	HC		V	293,8	19,0	17,4	59,2	120,0	5	75,0	160,8	14,7	BMW	34 21 1 165 563
BAR19109			V	242,0	19,1	17,0	40,5	104,0	4	86,0	143,0	M10x1,25	HYUNDAI	51712-24100
BAR20114			V	281,0	19,9	18,0	80,5	115,0	5	91,0	128,5	M14x1,5	VOLKSWAGEN	281 615 283 A
BAR20115	HC	L	V	236,0	20,0	17,0	41,0	100,0	4/6	60,0	123,0	14,0	CHEVROLET	90121445 96574633
													DAEWOO	90121445 96574633
													OPEL/AUXHALL	5 69 054/90511111
BAR20123		L	V	239,0	20,0	18,0	38,9	100,0	4	65,0	125,0	13,6	AUDI/SEAT/VW	321 615 301 C
BAR20125			V	238,0	20,1	17,7	40,9	100,0	4	61,0	128,0	13,0	NISSAN	40206-00QAJ
BAR20126			V	259,0	20,2	17,7	46,3	100,0	4	61,0	130,0	12,8	RENAULT	77 01 204 286 77 00 715 081 77 01 204 283
BAR20128	HC	L	V	256,0	20,0	18,0	38,8	100,0	4	65,0	131,5	13,8	SEAT/VW	321 615 301 D 6N0 615 301 D
BAR20132			V	247,0	20,4	18,5	34,2	108,0	4	66,0	133,2	13,0	CITROEN PEUGEOT	95 661 747 4246 A7 4249 96
BAR20133			V	266,0	20,5	18,5	27,4	108,0	4	66,0	133,0	13,0	CITROEN PEUGEOT	4246 W6 4246 97 4246 W5
BAR20142		L	V	257,5	20,0	18,2	40,5	98,0	4	59,0	126,7	13,0	ALFA/FIAT/LANCIA	7779409 46423415 51749124 60806137 60810076 60811256 60811266
BAR20147			V	239,7	20,0	18,0	43,0	108,0	4	63,5	136,0	13,7	FORD/MAZDA	1019604 1066271 1320581 1320582 5028281
BAR20154	HC		V	297,8	20,0	18,4	61,1	120,0	5	75,0	185,0	14,6	BMW	34 21 1 164 175 34 21 6 767 060
BAR20155		L	V	257,5	20,0	18,2	40,5	98,0	5	59,0	126,5	16,5	CITROEN FIAT PEUGEOT	4246 H9 1316323080 4246 H8
BAR20171			V	286,0	20,0	18,0	67,0	110,0	5	65,5	160,0	14,1	OPEL/AUXHALL	5 69 100/9195052
BAR20174			V	240,0	19,9	17,0	41,1	100,0	4/6	60,0	126,0	14,3	OPEL/AUXHALL	5 69 021/9195985
BAR20183	HC		V	320,0	20,0	18,4	63,2	120,0	5	75,0	185,0	14,5	BMW	34 21 6 772 085
BAR21105			V	262,0	21,0	19,0	44,7	100,0	4	64,1	141,0	13,0	HONDA	45251-S5D-A10 45251-S6D-E10 45251-SCC-900 45251-SK7-A00 45251-SK7-A10 45251-SR0-A00 45251-SR0-A10 45251-ST3-E10 45251-TG5-H00
													ROVER	GBD90840 SDB000990
BAR21106			V	259,0	20,7	17,7	41,0	100,0	4	61,0	130,0	12,8	NISSAN DACIA/RENAULT	40206-00QAA 60 01 548 578 77 00 842 131 77 01 204 828 77 01 206 339 77 11 130 038



# Abmessungen Bremsscheiben

Dimensions disques de frein / Misure dischi freno /

Dimensões dos discos dos travões / Wymiary tarcz hamulcowych /

Rozměry brzdových kotoučů

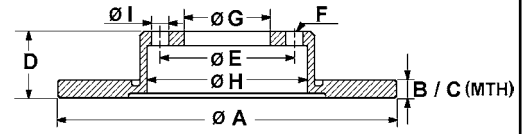

HC hochgekohlt - high carbon - ad alto tenore di carbonio - à haute teneur en carbone - altamente carbonizado  
L legiert - alloyed - alligato/legato - allié - aleado  
V ventiliert - ventilated - ventilato - ventilé - ventilado

	HC	L	V	A	B	C	D	E	F	G	H	I	OE - #
BAR22100	HC		V	280,0	22,0	20,0	28,5	100,0	5	65,0	141,0	15,8	SEAT/VW 1H0 615 301 A
BAR22103	HC		V	302,0	22,0	20,4	76,0	120,0	5	79,0	148,7	14,5	BMW 34 11 1 160 936
BAR22108	HC		V	256,0	22,0	20,0	56,5	108,0	4	68,0	132,7	15,4	AUDI 895 615 301 A
BAR22115	HC		V	286,0	22,0	20,4	51,6	120,0	5	79,0	148,0	14,8	BMW 34 11 1 165 455 34 11 6 766 239
BAR22118			V	257,0	21,9	20,0	46,2	108,0	4	68,0	133,0	15,5	AUDI 443 615 301 B
BAR22122		L	V	260,0	22,0	20,4	35,0	100,0	4	66,0	138,0	14,5	BMW 34 11 1 160 915
BAR22132	HC	L	V	284,0	22,0	19,4	43,5	112,0	5	67,0	154,3	12,8	MERCEDES BENZ 202 421 09 12
BAR22139	HC		V	279,7	21,9	20,0	56,3	108,0	4	68,0	145,8	15,5	AUDI 8A0 615 301 E
BAR22147			V	284,0	22,0	20,2	43,5	98,0	4	59,0	127,0	13,3	ALFA/FIAT/LANCIA 46403959 46448168 46455892 46455892 46758714 60810404 82450657
BAR22148		L	V	262,0	22,0	19,8	44,0	100,0	4	61,0	132,0	13,0	RENAULT 77 01 205 840
BAR22150	HC		V	279,9	22,0	19,0	36,5	100,0	5	65,0	133,4	16,0	AUDI/SEAT/SKODA/VW 1J0 615 301 E 1J0 615 301 M 1J0 615 301 P
BAR22151	HC		V	256,0	22,0	19,0	36,7	100,0	5	65,0	133,5	15,6	AUDI/SEAT/SKODA/VW 1J0 615 301 D 1J0 615 301 L 6R0 615 301
BAR22152	HC		V	280,0	22,0	20,0	46,4	112,0	5/9	68,0	146,5	15,3	AUDI/VW AUDI/VW 8Z0 615 301 D 8E0 615 301 B 8E0 615 301 D 8E0 615 301 P
BAR22158			V	255,0	22,0	20,0	48,0	100,0	4	55,0	131,0	14,5	TOYOTA 43512-12550
BAR22159	HC		V	295,8	22,0	20,4	76,0	120,0	5	79,0	149,0	14,6	BMW 34 11 6 767 061
BAR22160	HC		V	299,8	22,0	20,4	51,6	120,0	5	79,0	163,8	14,7	BMW 34 11 1 164 539 34 11 6 757 526 34 11 6 766 224 34 11 6 855 152
BAR22161	HC	L	V	276,0	22,0	19,0	77,0	130,0	5	85,0	156,3	15,0	MERCEDES BENZ 902 421 06 12 902 421 07 12 902 421 09 12 VOLKSWAGEN 2D0 615 301 C 2D0 615 301 D
BAR22162	HC	L	V	276,0	22,0	19,0	60,0	112,0	5	67,0	153,0	15,0	MERCEDES BENZ 638 421 01 12
BAR22163	HC		V	256,0	22,0	20,0	36,6	100,0	5	65,0	135,0	15,8	AUDI/VW 8N0 615 601 B
BAR22166			V	235,0	22,0	20,0	45,0	100,0	4	55,0	125,0	13,0	MAZDA BR70-33-25XF
BAR22168	HC	L	V	260,0	22,0	19,4	40,5	112,0	5	67,0	145,0	13,0	MERCEDES BENZ 168 421 02 12 168 421 08 12
BAR22172			V	258,0	22,0	20,0	43,4	108,0	4	63,5	136,0	13,7	FORD 1320585 1323620 MAZDA DD32-33-25X DD59-33-25X DD63-33-25XA
BAR22194			V	266,0	22,0	20,0	34,2	108,0	4	66,0	133,1	13,0	CITROEN 4246 W1 4249 83 4249 G1 PEUGEOT 4246 W7 4249 83 4249 G1
BAR22196	HC	L	V	285,0	22,0	19,0	93,0	145,0	6	120,0	169,0	15,0	MERCEDES BENZ VOLKSWAGEN 904 423 03 12 2D0 615 601 B
BAR22197			V	257,5	22,0	20,2	40,5	98,0	4	59,0	127,0	13,0	CITROEN 4249 74 4249 L2 FIAT/LANCIA 46401356 46542383 46831041 51896287 51896288 PEUGEOT 4249 73 4249 L2

# Abmessungen Bremsscheiben

Dimensions disques de frein / Misure dischi freno /  
Dimensões dos discos dos travões / Wymiary tarcz hamulcowych /  
Rozměry brzdových kotoučů

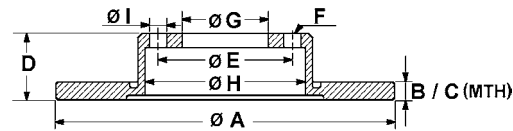

HC hochgekohlt - high carbon - ad alto tenore di carbonio - à haute teneur en carbone - altamente carbonizado  
L legiert - alloyed - alligato/legato - alié - aleado  
V ventiliert - ventilated - ventilato - ventilé - ventilado

	HC	L	V	A	B	C	D	E	F	G	H	I	OE - #
BAR22206			V	284,0	22,0	19,0	38,2	100,0	5	64,2	142,0	15,3	ROVER GBD90844 SDB000880 SDB100940
BAR22209	HC		V	320,0	22,0	20,4	60,5	120,0	5	75,0	185,0	14,5	BMW 34 20 1 166 073
BAR22210	HC		V	279,9	22,0	19,0	49,4	112,0	5/9	65,0	144,2	15,3	AUDI/SEAT/SKODA/VW 1K0 615 301 AK VOLKSWAGEN 5C0 615 301
BAR22211	HC		V	294,0	21,9	19,5	44,4	120,0	5	76,0	154,6	16,6	VOLKSWAGEN 7H0 615 601 B
BAR22245	HC	L	V	285,0	22,0	19,0	72,0	130,0	5	85,0	156,3	15,0	MERCEDES BENZ 903 421 01 12
BAR24103			V	252,0	24,0	22,0	53,5	95,0	6	76,0	102,0	M10x1,5	OPEL/VAUXHALL 44 03 283/9111283 RENAULT 77 01 204 281
BAR24111			V	258,0	23,9	21,0	58,4	110,0	5	70,0	139,0	14,3	OPEL/VAUXHALL 5 69 039/90271134
BAR24112			V	239,7	24,2	22,2	58,4	108,0	4	63,5	136,0	13,7	FORD 5022659 5022660 5022948 5023573
BAR24115		L	V	256,0	24,0	21,0	41,0	100,0	4/6	60,0	123,0	14,5	DAEWOO 96179110 OPEL/VAUXHALL 5 69 001/90487402
BAR24118		L	V	280,0	24,0	20,0	65,0	112,0	5	68,2	144,0	16,5	VOLKSWAGEN 701 615 301 D
BAR24120			V	260,0	24,0	22,2	47,0	108,0	4	63,5	136,0	13,7	FORD 4070865 5026784
BAR24127			V	280,0	24,0	21,9	67,6	118,0	5	73,0	142,0	15,5	CITROEN 4246 Y1 4249 99 4249 K3 FIAT 46806233 51740244 51848619 PEUGEOT 4246 X9 4249 99 4249 K3
BAR24128		L	V	280,0	24,0	20,0	55,0	112,0	5	68,0	144,0	17,0	VOLKSWAGEN 7D0 615 301 C
BAR24129			V	258,0	24,0	22,0	48,6	114,3	5	72,0	143,0	13,0	FORD 3958455 MAZDA GA2Y-33-25X GA4Y-33-25X GA4Y-33-25XC GA4Y-33-25XD GA4Y-33-25XJ GA5Y-33-25X GA5Y-33-25XD
BAR24131			V	254,0	24,3	22,2	42,9	100,0	5	78,5	104,5	M10	FORD 5025610 5029815
BAR24132			V	270,0	24,3	22,2	42,9	100,0	5	78,5	104,5	M10	FORD 5029816
BAR24136			V	256,0	24,0	21,5	45,5	114,3	4	69,0	145,0	12,6	MITSUBISHI MR205584 MR205585 VOLVO 30872926
BAR24138			V	300,0	24,0	21,9	65,5	130,0	5	80,0	161,0	17,5	CITROEN 4246 Y3 4249 36 4249 H2 FIAT 46806234 51728378 51740247 51858363 PEUGEOT 4246 Y5 4249 35 4249 H2
BAR24139			V	260,0	24,0	22,0	28,0	108,0	4	66,0	133,5	13,0	PEUGEOT 4246 L9
BAR24146			V	256,0	24,0	22,4	45,0	114,3	4	69,0	145,0	12,6	HYUNDAI/KIA 51712-M2010 MITSUBISHI MB668886 MB950570
BAR24152	HC	L	V	256,0	24,0	21,0	41,0	100,0	4	60,0	123,0	14,3	OPEL/VAUXHALL 5 69 059/9117677
BAR24158	HC	L	V	280,0	24,0	21,8	44,0	100,0	4	61,0	140,0	13,6	RENAULT 77 01 207 829
BAR24159			V	281,0	24,0	21,5	45,8	114,3	4	69,0	147,0	12,5	MITSUBISHI M818027 VOLVO 30818027
BAR24161			V	300,0	24,0	22,0	47,0	108,0	5	63,5	155,0	13,7	FORD 1376118 4179398 4181042 JAGUAR C2S 35270 C2S 42667

# Abmessungen Bremsscheiben

Dimensions disques de frein / Misure dischi freno /

Dimensões dos discos dos travões / Wymiary tarcz hamulcowych /

Rozměry brzdových kotoučů

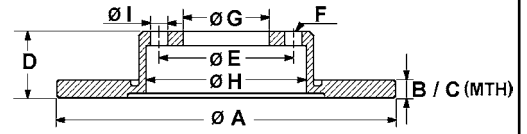

HC hochgekohlt - high carbon - ad alto tenore di carbonio - à haute teneur en carbone - altamente carbonizado  
L legiert - alloyed - alligato/legato - alié - aleado  
V ventiliert - ventilated - ventilato - ventilé - ventilado

	HC	L	V	A	B	C	D	E	F	G	H	I	OE - #
BAR24162			V	280,0	24,0	21,0	61,5	110,0	6	79,5	119,0	M10x1,5	OPEL/VAUXHALL RENAULT 45 00 098/9160398 77 00 302 128
BAR24164			V	258,0	23,9	22,0	47,0	100,0	4	55,0	125,0	13,0	MAZDA BJ1Y-33-25X
BAR24166		L	V	260,0	24,0	21,0	41,0	100,0	4/6	60,0	126,0	14,5	OPEL/VAUXHALL 5 69 000/9196050
BAR24170			V	276,0	24,0	22,4	45,0	114,3	4	69,0	145,0	12,5	mitsubishi MR389725 MR475331
BAR24171	HC	L	V	280,0	24,0	21,8	44,0	108,0	5	61,0	140,0	15,5	RENAULT 77 01 206 198
BAR24181	HC		V	310,0	24,0	22,4	77,1	120,0	5	79,0	161,0	14,5	BMW 34 11 6 764 021
BAR24192			V	256,0	24,0	21,5	45,6	114,3	4	69,0	139,0	12,7	mitsubishi SMART 4605A068 454 420 00 01
BAR25105	HC		V	287,6	24,8	23,0	46,3	112,0	5	68,0	135,0	15,6	AUDI/SKODA 4A0 615 301 C 8E0 615 301 Q 4A0 615 301 D
BAR25110	HC	L	V	288,0	25,0	22,4	46,5	112,0	5	67,0	154,3	13,3	AUDI CHRYSLER MERCEDES BENZ 5098 063AA 203 421 03 12 210 421 07 12 210 421 24 12
BAR25113	HC		V	287,7	25,0	22,0	34,2	100,0	5	65,0	136,0	15,7	AUDI/SEAT/SKODA/VW 1J0 615 301 R 1J0 615 301 S 6R0 615 301 A
BAR25114		L	V	288,0	25,0	21,0	55,5	112,0	5	68,0	145,0	17,0	FORD SEAT/VW 1045994 7M0 615 301 G
BAR25115	HC		V	282,5	25,0	23,0	46,5	112,0	5	68,0	136,0	15,3	VOLKSWAGEN 8E0 615 301 A 8E0 615 301 C
BAR25119	HC	L	V	288,0	25,0	22,0	42,0	110,0	5/7	70,0	139,0	14,0	OPEL/VAUXHALL SAAB 5 69 056/90512029 32025723 5390786
BAR25123	HC		V	312,0	25,0	23,0	34,0	100,0	5/9	65,0	135,1	16,0	AUDI/SEAT/SKODA/VW AUDI/VW 8N0 615 301 A 8L0 615 301
BAR25124			V	255,0	24,9	24,0	49,2	100,0	5	55,0	156,0	14,5	TOYOTA 43512-20470 43512-20580 43512-20700
BAR25131	HC	L	V	280,0	25,0	22,0	42,0	110,0	5/7	70,0	139,0	14,0	OPEL/VAUXHALL 5 69 066/93197592
BAR25137	HC		V	312,0	25,0	23,0	46,3	112,0	5/9	68,0	158,0	15,3	AUDI/SKODA 4B0 615 301 A 8E0 615 301 R
BAR25138	HC		V	325,0	25,0	23,4	52,5	120,0	5	79,0	174,0	14,5	BMW 34 10 1 166 071 34 11 6 855 156
BAR25141	HC		V	285,0	24,9	22,0	42,1	110,0	5/7	70,0	139,0	14,0	FIAT OPEL/VAUXHALL SAAB 51819733 5 69 003/93171497 9156807 93171497
BAR25142	HC	L	V	308,0	25,0	22,0	42,0	110,0	5/8	70,0	139,0	14,0	OPEL/VAUXHALL SAAB 5 69 061/9194477 5391560 9184405
BAR25145	HC		V	287,8	24,9	22,0	49,7	112,0	5/9	65,0	144,2	15,3	AUDI/SEAT/SKODA/VW VOLKSWAGEN 1K0 615 301 T 5C0 615 301 A
BAR25148	HC	L	V	280,0	25,0	22,0	42,0	100,0	4/6	60,0	139,0	14,5	OPEL/VAUXHALL 5 69 006/93175376
BAR25158	HC		V	312,0	25,0	22,0	49,7	112,0	5/9	65,0	146,0	15,3	AUDI/VW/SKODA VOLKSWAGEN 1K0 615 301 AA 5C0 615 301 B
BAR25162	HC		V	300,0	25,0	23,0	48,5	108,0	5	63,5	140,0	13,7	FORD 1253965 1373370 1520297 VOLVO 274510 31262719
BAR25171	HC		V	287,9	25,0	23,0	46,3	112,0	5/10	68,0	136,8	15,3	SKODA/VW 4B0 615 301 B
BAR26102			V	280,0	26,0	23,0	50,2	108,0	5	68,0	139,0	14,8	VOLVO 271788 272312
BAR26104			V	281,0	26,0	24,2	43,5	98,0	5	59,0	127,0	16,5	CITROEN FIAT/LANCIA PEUGEOT 4246 J3 1317651080 4246 J2
BAR26105			V	280,0	26,0	23,0	56,3	108,0	5	68,0	139,0	14,0	VOLVO 31262209 3516567 6848902
BAR26106			V	283,0	26,0	24,2	28,2	108,0	4	66,0	133,5	13,0	CITROEN PEUGEOT 4246 L8 4246 R7
BAR26108			V	256,5	26,0	24,0	52,2	114,3	5	68,0	139,5	12,8	NISSAN 40206-9C100 40206-9C101

# Abmessungen Bremsscheiben

Dimensions disques de frein / Misura dischi freno /

Dimensões dos discos dos travões / Wymiary tarcz hamulcowych /

Rozměry brzdových kotoučů

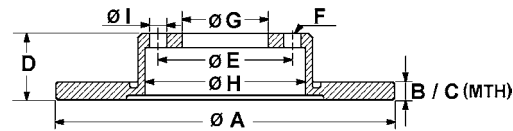

HC hochgekohlt - high carbon - ad alto tenore di carbonio - à haute teneur en carbone - altamente carbonizado

L legiert - alloyed - alligato/legato - alié - aleado

V ventiliert - ventilated - ventilato - ventilé - ventilado

	HC	L	V	A	B	C	D	E	F	G	H	I	OE - #
BAR26109			V	277,0	26,0	24,0	39,0	124,0	6	100,0	164,0	M10x1,25	FORD NISSAN 1954433 40206-0F000 40206-0F001 40206-31G01
BAR26115		L	V	300,0	26,0	22,0	56,0	112,0	5	68,2	145,5	16,5	FORD SEAT/VW 7M3 615 301 A 1141782
BAR26116	HC		V	303,0	26,0	23,0	51,5	112,0	5	67,0	168,0	15,0	MERCEDES BENZ 163 421 02 12 163 421 04 12
BAR26120			V	283,0	26,0	24,0	34,2	108,0	4	66,0	133,5	13,0	CITROEN 4246 W2 4249 18 4249 84 4249 J6 PEUGEOT 4246 W8 4249 17 4249 84 4249 J6
BAR26122			V	285,8	26,0	23,0	50,3	108,0	5	68,0	139,0	16,8	VOLVO 272403 946133
BAR26138			V	295,0	26,0	24,0	49,2	114,3	5	62,0	141,0	14,5	TOYOTA 43512-0F010 43512-05080
BAR28101	HC		V	302,0	28,0	26,4	76,0	120,0	5	79,0	148,5	14,5	BMW 34 11 6 756 090
BAR28102	HC	L	V	300,0	28,0	25,4	68,3	112,0	5	80,0	145,0	15,0	MERCEDES BENZ 126 421 05 12
BAR28104		L	V	296,0	28,0	25,0	58,5	110,0	5	70,0	139,0	14,0	OPEL/VAUXHALL 5 69 044/90392559
BAR28106	HC	L	V	300,0	28,0	25,4	46,5	112,0	5	67,0	154,0	13,3	CHRYSLER 5098 064AA MERCEDES BENZ 203 421 05 12 210 421 22 12 210 421 25 12
BAR28123			V	305,0	27,9	25,0	50,3	108,0	5	68,0	139,0	16,6	VOLVO 274170 274559 9492715
BAR28129			V	305,5	28,0	25,0	77,8	130,0	5	90,0	157,0	16,0	NISSAN 40206-00QAD OPEL/VAUXHALL 44 03 038/9111038 RENAULT 77 00 314 064
BAR28132	HC		V	305,5	28,0	24,0	49,7	118,0	5	72,0	154,0	15,6	NISSAN 40206-00QAE 40206-00QAF 40206-00QAG 40206-00QAH OPEL/VAUXHALL 44 14 632/91165426 RENAULT 77 11 130 077
BAR28136			V	285,0	28,0	26,0	43,5	98,0	5	59,0	127,0	16,5	CITROEN 4246 P2 FIAT/LANCIA 1325772080 PEUGEOT 4246 P1
BAR28140			V	280,0	28,0	26,0	49,1	114,3	5	68,0	144,0	12,8	NISSAN 40206-3Y502 40206-3Y503 40206-4U101 40206-4U103 40206-4U107
BAR28141	HC	L	V	295,0	28,0	25,4	54,5	112,0	5	67,0	154,0	15,0	MERCEDES BENZ 211 421 07 12
BAR28142	HC	L	V	312,0	28,0	25,4	64,5	112,0	5	67,0	154,0	15,0	MERCEDES BENZ 211 421 09 12
BAR28176	HC	L	V	295,0	28,0	25,4	54,5	112,0	5	67,0	154,0	15,0	MERCEDES BENZ 211 421 08 12
BAR30101	HC		V	324,0	30,0	28,4	77,0	120,0	5	79,0	149,0	14,5	BMW 34 11 6 757 746
BAR30107	HC		V	323,8	30,0	28,4	73,7	120,0	5	79,0	149,0	14,7	BMW 34 11 6 767 059
BAR30109	HC		V	332,0	30,0	28,4	62,0	120,0	5	75,0	158,0	16,5	BMW 34 11 6 750 713 34 11 6 756 045 34 11 6 765 457 34 11 6 766 036
BAR30113	HC		V	320,0	30,0	28,0	46,1	112,0	5/9	68,0	136,0	15,3	AUDI 8D0 615 301 M
BAR30173	HC		V	324,0	30,0	28,4	77,2	120,0	5	79,0	165,0	14,5	BMW 34 11 6 753 221
BAR32115	HC	L	V	330,0	32,0	30,0	76,0	112,0	5	67,0	154,0	15,0	MERCEDES BENZ 220 421 25 12

# Abbildungen Bremsschläuche

Illustrations flexibles de frein / Illustrazioni flessibile freno / Figuras tubos de travão /  
Rysunki Przewód hamulcowy giętki / Hadice brzdy

**BAH0001**

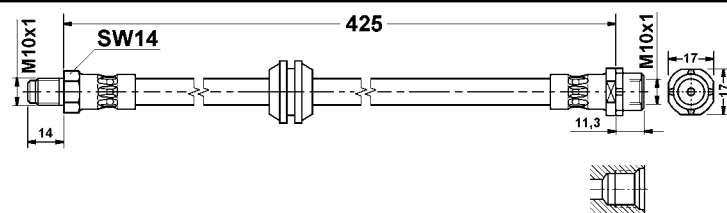

**BAH0003**

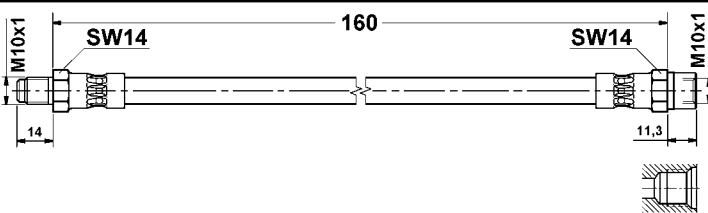

**BAH0004**

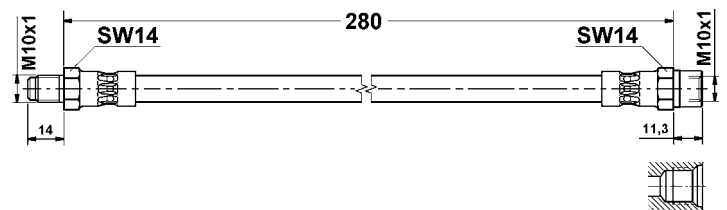

**BAH0005**

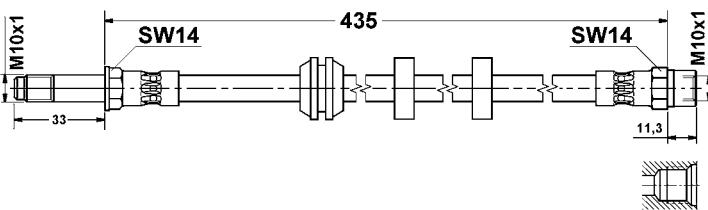

**BAH0006**

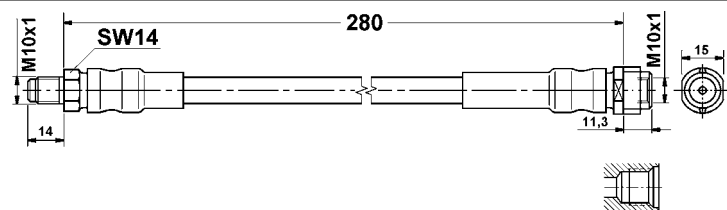

**BAH0007**

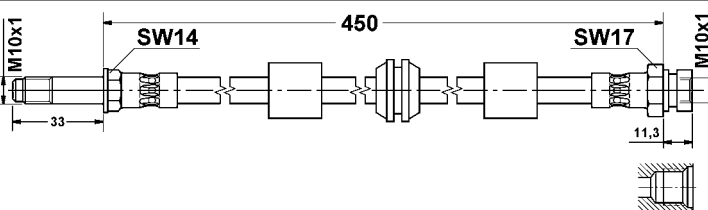

**BAH0008**

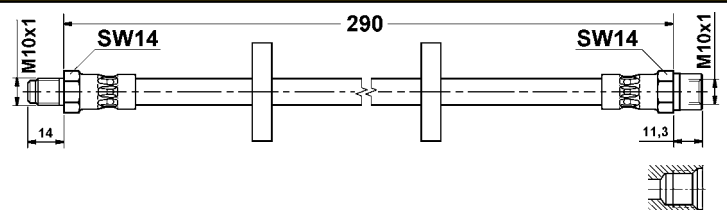

**BAH0009**

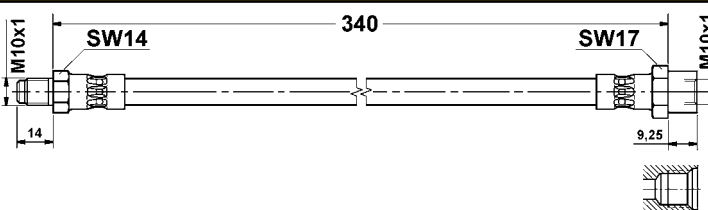

**BAH0010**

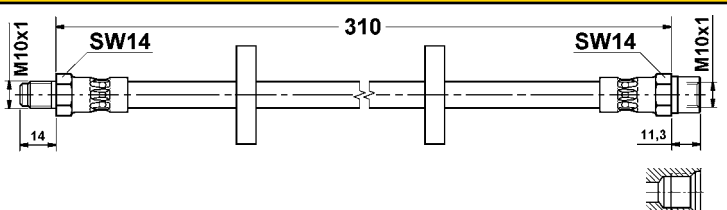

**BAH0011**

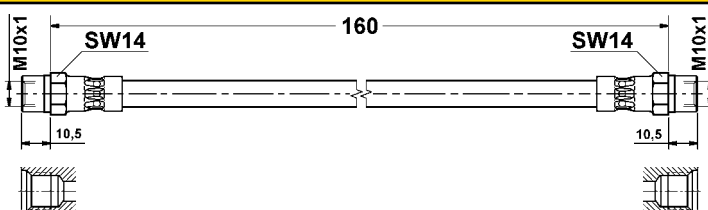

**BAH0012**

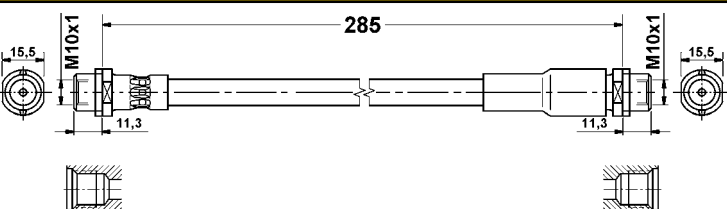

**BAH0013**

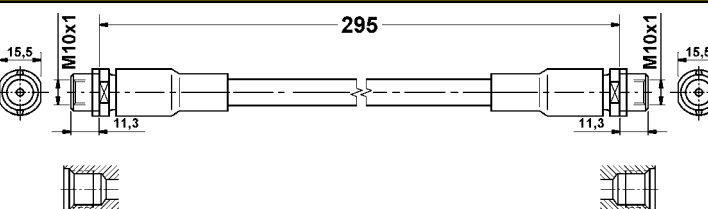

**BAH0014**

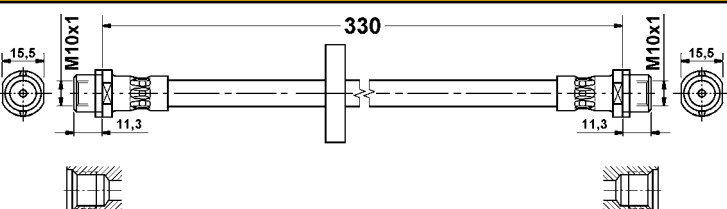

**BAH0015**

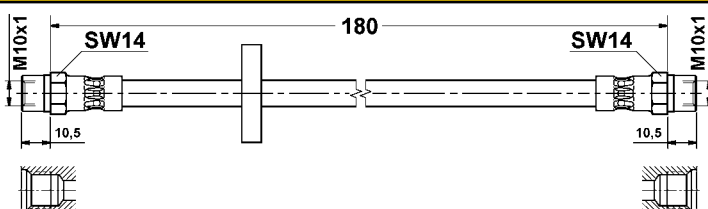

# Abbildungen Bremsschläuche

Illustrations flexibles de frein / Illustrazioni flessibile freno / Figuras tubos de travão /

Rysunki Przewód hamulcowy giętki / Hadice brzdy

**BAH0016**

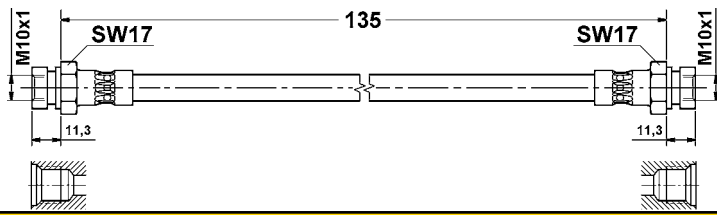

**BAH0017**

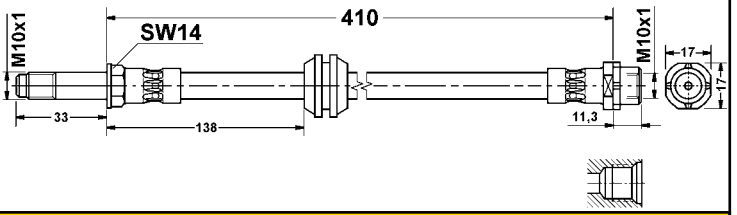

**BAH0018**

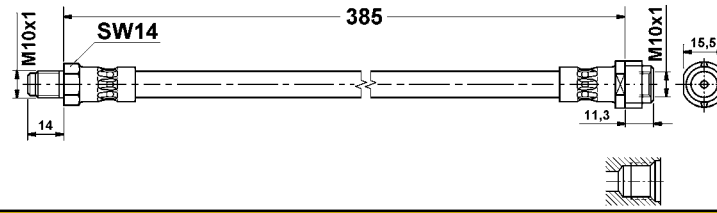

**BAH0019**

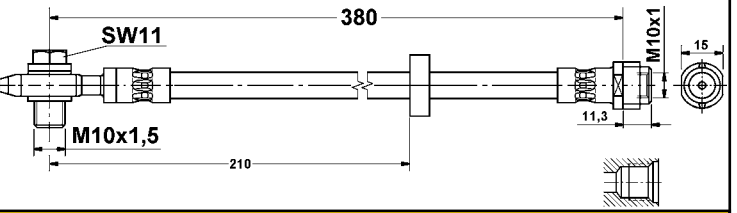

**BAH0020**

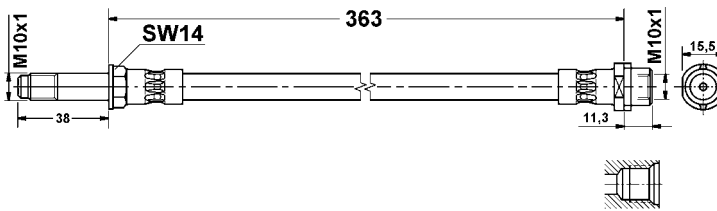

**BAH0021**

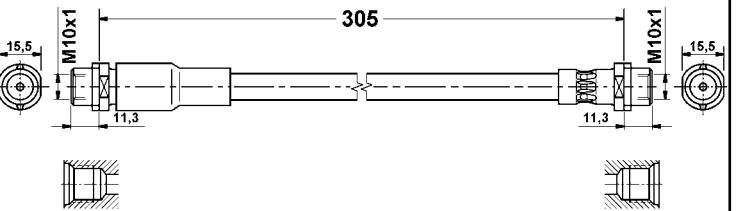

**BAH0022**

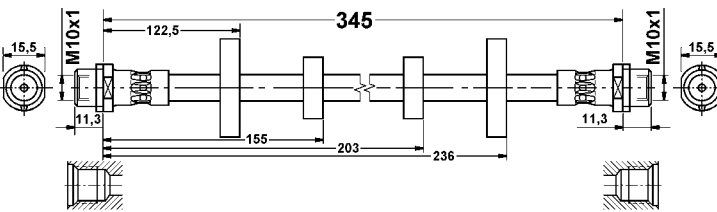

**BAH0023**

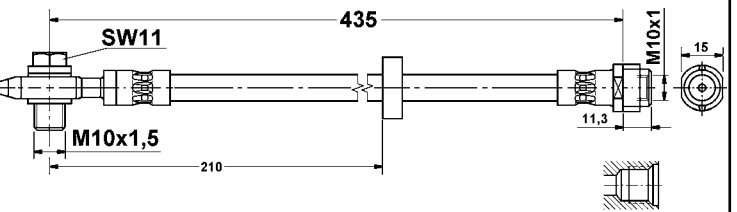

**BAH0024**

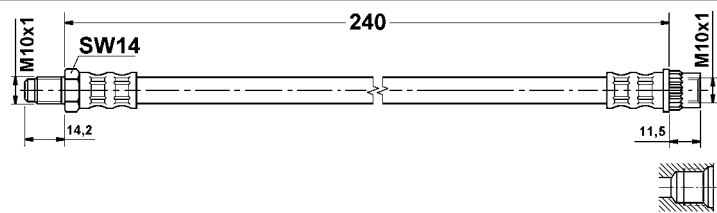

**BAH0025**

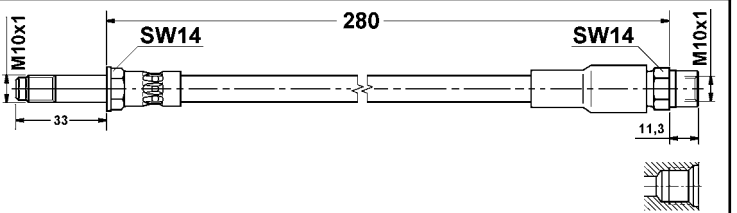

**BAH0026**

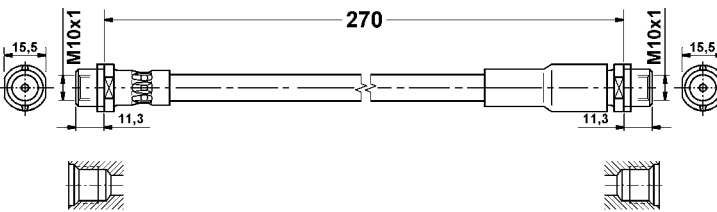

**BAH0027**

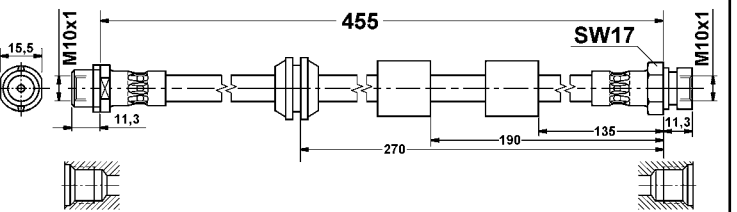

**BAH0028**

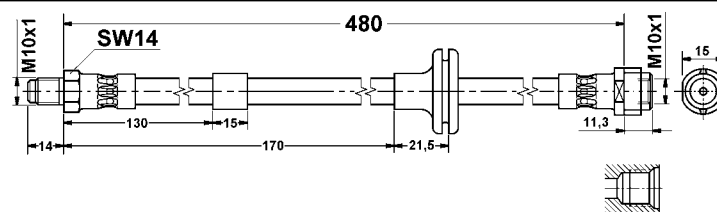

**BAH0029**

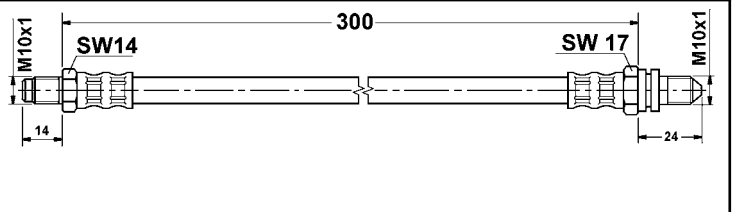

# Abbildungen Bremsschläuche

Illustrations flexibles de frein / Illustrazioni flessibile freno / Figuras tubos de travão /  
Rysunki Przewód hamulcowy giętki / Hadice brzdy

**BAH0030**

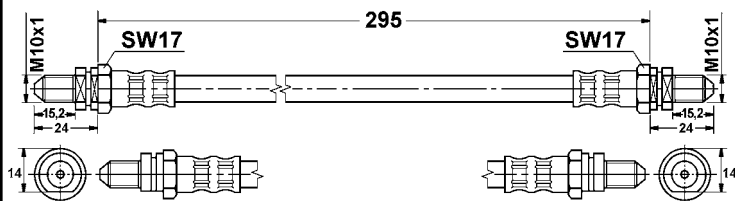

**BAH0031**

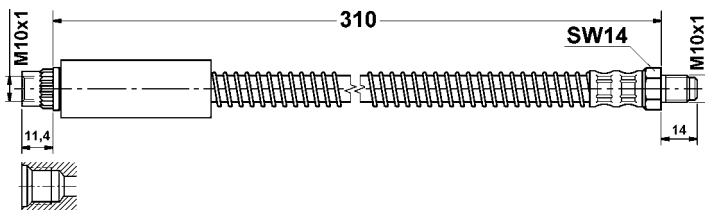

**BAH0032**

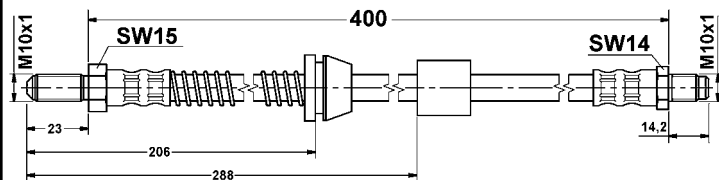

**BAH0033**

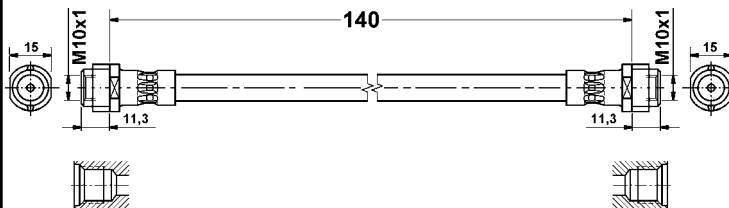

# Vergleichsliste WVA → Barum

Liste des correspondances WVA → Barum / Tabella di conversione codici WVA → Barum /  
 Lista de comparação WVA → Barum / Lista porównawcza numerów WVA → Barum /  
 Porovnávací seznam čísel WVA → Barum

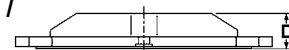

WVA	D	Barum	WVA	D	Barum	WVA	D	Barum
20073	17,3	BA2062	20775	18,0	BA2065	20987	18,0	BA2055
20162	15,4	BA2106	20776	18,0	BA2065	20989	17,5	BA2036
20164	18,2	BA2181	20777	18,0	BA2065	20995	17,3	BA2054
20166	16,0	BA2041	20784	18,0	BA2101	20996	17,3	BA2054
20168	16,3	BA2037	20787	19,2	BA2024	21012	15,0	BA2111
20168	19,6	BA2038	20833	17,1	BA2034	21012	15,0	BA2292
20180	17,3	BA2053	20834	17,1	BA2034	21016	17,0	BA2060
20181	17,3	BA2053	20838	17,1	BA2034	21022	17,5	BA2036
20236	18,2	BA2013	20859	18,0	BA2056	21023	17,5	BA2036
20238	18,2	BA2013	20860	18,0	BA2056	21028	19,3	BA2029
20247	18,2	BA2013	20861	17,5	BA2039	21035	15,5	BA2162
20261	19,3	BA2285	20870	15,0	BA2121	21050	15,7	BA2095
20267	19,3	BA2285	20887	15,3	BA2133	21055	16,9	BA2027
20280	18,5	BA2109	20887	17,3	BA2141	21064	20,3	BA2125
20336	14,0	BA2082	20887	19,7	BA2132	21086	17,0	BA2060
20337	14,0	BA2082	20888	15,3	BA2133	21087	17,0	BA2060
20380	15,6	BA2019	20888	17,3	BA2141	21096	15,0	BA2077
20410	15,0	BA2107	20888	19,7	BA2132	21097	15,0	BA2077
20423	15,0	BA2107	20889	17,3	BA2131	21100	17,0	BA2033
20437	19,0	BA2193	20901	19,6	BA2028	21103	14,4	BA2035
20547	16,8	BA2136	20905	18,0	BA2055	21105	17,0	BA2033
20576	15,5	BA2126	20905	18,0	BA2066	21110	15,6	BA2019
20588	16,5	BA2185	20905	18,0	BA2074	21140	15,7	BA2098
20629	20,0	BA2188	20905	18,0	BA2083	21144	16,6	BA2052
20634	15,0	BA2075	20906	18,0	BA2055	21153	17,5	BA2182
20634	15,0	BA2077	20906	18,0	BA2066	21170	17,0	BA2040
20635	18,0	BA2056	20906	18,0	BA2074	21171	18,0	BA2084
20636	18,0	BA2056	20906	18,0	BA2083	21173	17,0	BA2026
20640	18,0	BA2144	20907	18,0	BA2334	21179	16,8	BA2096
20651	18,2	BA2322	20919	18,3	BA2050	21190	17,5	BA2137
20669	16,3	BA2178	20926	18,5	BA2086	21191	17,0	BA2097
20669	19,6	BA2028	20927	18,5	BA2086	21197	15,0	BA2161
20669	19,6	BA2031	20928	18,5	BA2086	21201	17,5	BA2137
20675	17,0	BA2189	20929	18,5	BA2086	21202	17,0	BA2146
20676	19,5	BA2135	20932	14,0	BA2068	21203	17,0	BA2146
20676	19,5	BA2205	20934	14,0	BA2068	21209	18,5	BA2043
20676	19,8	BA2333	20939	15,4	BA2134	21210	18,5	BA2043
20676	20,6	BA2148	20941	19,3	BA2029	21217	17,5	BA2014
20676	20,6	BA2172	20961	15,2	BA2032	21267	17,0	BA2097
20678	19,5	BA2135	20961	17,2	BA2017	21273	19,5	BA2244
20687	13,5	BA2093	20961	17,2	BA2228	21274	19,5	BA2244
20687	15,5	BA2094	20968	20,3	BA2125	21278	17,0	BA2099
20741	19,2	BA2024	20973	11,0	BA2076	21278	17,0	BA2250
20753	18,0	BA2144	20974	11,0	BA2076	21279	17,0	BA2099
20756	17,0	BA2189	20979	19,7	BA2025	21282	17,3	BA2167
20757	20,0	BA2188	20981	13,7	BA2030	21289	16,8	BA2096
20775	18,0	BA2064	20986	18,0	BA2055	21303	18,8	BA2174



# Vergleichsliste WVA → Barum

Liste des correspondances WVA → Barum / Tabella di conversione codici WVA → Barum /  
 Lista de comparação WVA → Barum / Lista porównawcza numerów WVA → Barum /  
 Porovnávací seznam čísel WVA → Barum

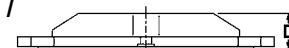

WVA	D	Barum	WVA	D	Barum	WVA	D	Barum
21305	15,5	BA2163	21593	18,5	BA2215	21768	16,0	BA2249
21353	16,8	BA2136	21601	17,5	BA2116	21769	16,0	BA2249
21363	16,0	BA2249	21602	17,5	BA2116	21773	15,0	BA2292
21365	17,0	BA2071	21603	17,5	BA2116	21774	15,0	BA2292
21368	18,3	BA2175	21613	18,2	BA2048	21794	20,3	BA2168
21373	16,0	BA2112	21614	17,5	BA2020	21795	19,1	BA2150
21374	16,0	BA2112	21615	17,5	BA2020	21797	19,7	BA2045
21375	16,0	BA2112	21616	17,5	BA2020	21797	19,7	BA2325
21378	15,0	BA2110	21621	17,0	BA2233	21798	19,7	BA2045
21379	16,0	BA2110	21622	17,0	BA2233	21799	19,7	BA2046
21380	16,0	BA2110	21624	20,6	BA2148	21800	19,7	BA2046
21388	18,3	BA2050	21626	15,8	BA2232	21801	19,0	BA2047
21394	18,0	BA2139	21631	17,0	BA2078	21802	19,0	BA2047
21396	18,0	BA2138	21635	18,2	BA2322	21827	17,3	BA2151
21396	18,0	BA2139	21637	19,3	BA2315	21829	20,3	BA2207
21430	17,3	BA2140	21641	19,3	BA2315	21848	19,5	BA2147
21430	17,3	BA2151	21642	19,3	BA2166	21848	19,6	BA2269
21432	17,3	BA2140	21643	17,8	BA2108	21849	19,5	BA2147
21436	17,0	BA2072	21644	17,8	BA2108	21849	19,6	BA2269
21436	17,0	BA2073	21646	20,6	BA2148	21857	16,8	BA2100
21436	17,0	BA2302	21647	16,0	BA2117	21861	15,3	BA2226
21439	20,3	BA2044	21648	16,0	BA2117	21866	15,3	BA2153
21459	18,5	BA2187	21649	16,0	BA2117	21866	17,3	BA2152
21460	18,2	BA2048	21654	15,0	BA2115	21866	19,7	BA2145
21463	18,0	BA2023	21655	15,0	BA2115	21868	15,3	BA2153
21469	19,0	BA2080	21656	15,0	BA2115	21868	17,3	BA2152
21470	19,0	BA2081	21657	16,4	BA2113	21868	19,7	BA2145
21479	19,2	BA2049	21658	16,4	BA2113	21883	19,6	BA2171
21479	19,2	BA2321	21659	16,4	BA2113	21883	19,6	BA2201
21481	15,5	BA2119	21664	19,1	BA2150	21885	19,6	BA2171
21486	19,3	BA2166	21670	20,3	BA2168	21885	19,6	BA2201
21487	17,3	BA2167	21674	19,3	BA2016	21888	18,0	BA2022
21515	17,5	BA2010	21676	19,5	BA2169	21889	18,0	BA2022
21516	17,5	BA2010	21676	20,3	BA2190	21891	17,3	BA2170
21517	17,5	BA2010	21677	19,5	BA2169	21897	18,5	BA2187
21518	17,0	BA2011	21691	17,3	BA2170	21899	15,1	BA2206
21520	17,5	BA2012	21697	15,0	BA2274	21900	15,8	BA2213
21521	17,5	BA2012	21698	15,0	BA2274	21904	17,0	BA2250
21522	17,5	BA2012	21699	15,0	BA2274	21911	20,3	BA2333
21543	16,5	BA2114	21719	15,0	BA2280	21911	20,6	BA2205
21544	16,5	BA2114	21720	15,0	BA2280	21919	15,8	BA2164
21545	14,9	BA2227	21721	15,0	BA2280	21920	15,1	BA2268
21576	20,5	BA2149	21724	18,2	BA2015	21927	17,9	BA2143
21577	20,5	BA2149	21749	18,2	BA2015	21929	17,9	BA2143
21582	18,0	BA2138	21754	15,8	BA2118	21930	17,9	BA2142
21586	15,7	BA2276	21755	15,8	BA2118	21930	17,9	BA2332
21592	18,5	BA2215	21756	15,8	BA2118	21932	17,9	BA2142

# Vergleichsliste WVA → Barum

Liste des correspondances WVA → Barum / Tabella di conversione codici WVA → Barum /  
 Lista de comparação WVA → Barum / Lista porównawcza numerów WVA → Barum /  
 Porovnávací seznam čísel WVA → Barum

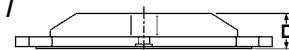

WVA	D	Barum	WVA	D	Barum	WVA	D	Barum
21945	16,3	BA2018	23189	16,7	BA2192	23379	20,4	BA2236
21945	19,6	BA2160	23190	16,7	BA2192	23392	20,6	BA2205
21945	19,6	BA2198	23191	16,7	BA2192	23393	19,6	BA2198
21980	18,0	BA2090	23192	16,7	BA2192	23402	20,4	BA2236
21981	18,0	BA2090	23193	16,3	BA2191	23403	20,4	BA2236
21983	17,3	BA2237	23194	16,3	BA2191	23407	19,3	BA2282
21999	15,5	BA2217	23195	17,3	BA2191	23410	15,7	BA2286
23001	15,5	BA2217	23196	17,3	BA2191	23411	15,7	BA2286
23018	20,6	BA2172	23200	18,8	BA2203	23417	15,2	BA2194
23019	20,6	BA2172	23201	18,8	BA2203	23418	19,6	BA2231
23020	17,9	BA2290	23202	18,8	BA2199	23419	19,6	BA2231
23021	18,9	BA2216	23215	18,3	BA2317	23434	18,5	BA2262
23022	20,9	BA2091	23224	16,5	BA2200	23435	18,5	BA2262
23034	19,6	BA2231	23224	16,5	BA2202	23445	19,2	BA2321
23042	18,7	BA2079	23225	17,0	BA2210	23446	16,5	BA2200
23057	19,6	BA2211	23226	17,0	BA2210	23446	16,5	BA2202
23058	19,6	BA2211	23234	16,8	BA2122	23463	16,6	BA2273
23059	19,6	BA2211	23241	15,8	BA2123	23480	18,8	BA2295
23063	17,3	BA2173	23245	18,2	BA2288	23481	18,8	BA2295
23064	17,3	BA2173	23245	18,3	BA2316	23482	16,4	BA2235
23066	18,8	BA2173	23247	18,2	BA2288	23482	16,4	BA2238
23067	18,8	BA2173	23253	15,9	BA2260	23482	16,4	BA2258
23070	17,0	BA2176	23254	15,9	BA2260	23483	16,4	BA2238
23073	18,8	BA2253	23257	15,9	BA2260	23510	16,5	BA2294
23074	18,8	BA2253	23258	16,9	BA2197	23511	16,5	BA2294
23076	17,2	BA2279	23259	16,9	BA2197	23512	16,5	BA2294
23077	17,2	BA2279	23262	16,9	BA2197	23516	17,2	BA2228
23093	16,6	BA2273	23263	16,9	BA2197	23517	16,3	BA2271
23094	16,5	BA2278	23269	20,1	BA2318	23521	14,0	BA2293
23099	18,4	BA2254	23270	20,1	BA2318	23522	14,0	BA2293
23115	20,3	BA2207	23271	17,7	BA2184	23523	14,0	BA2293
23124	19,0	BA2021	23271	17,7	BA2204	23543	15,7	BA2291
23125	19,0	BA2021	23279	18,5	BA2224	23544	15,7	BA2291
23130	19,6	BA2154	23281	18,3	BA2267	23545	15,7	BA2291
23130	19,6	BA2155	23282	18,3	BA2267	23554	16,4	BA2212
23131	19,6	BA2154	23289	19,3	BA2315	23557	17,2	BA2225
23131	19,6	BA2155	23300	18,0	BA2084	23563	16,5	BA2278
23138	14,6	BA2220	23301	18,0	BA2084	23564	16,5	BA2278
23144	19,8	BA2177	23302	18,0	BA2320	23581	18,8	BA2298
23145	19,8	BA2177	23312	19,6	BA2245	23587	19,6	BA2195
23154	19,0	BA2209	23324	20,6	BA2269	23588	19,6	BA2195
23155	19,0	BA2209	23326	17,4	BA2243	23589	19,6	BA2195
23163	19,6	BA2201	23334	16,1	BA2218	23597	18,0	BA2089
23172	18,3	BA2219	23335	16,1	BA2218	23598	18,0	BA2089
23181	17,9	BA2332	23347	19,6	BA2245	23599	19,0	BA2214
23183	20,3	BA2190	23353	15,0	BA2208	23600	19,0	BA2229
23187	19,6	BA2155	23378	20,4	BA2236	23602	19,7	BA2325

# Vergleichsliste WVA → Barum

Liste des correspondances WVA → Barum / Tabella di conversione codici WVA → Barum /  
 Lista de comparação WVA → Barum / Lista porównawcza numerów WVA → Barum /  
 Porovnávací seznam čísel WVA → Barum

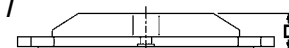

WVA	D	Barum	WVA	D	Barum	WVA	D	Barum
23604	18,8	BA2199	23843	18,8	BA2298	24578	16,3	BA2330
23613	17,8	BA2251	23844	19,7	BA2255	24595	18,9	BA2329
23620	16,7	BA2326	23881	20,1	BA2310	24608	18,9	BA2329
23621	16,7	BA2326	23914	16,3	BA2196	24673	18,0	BA2335
23622	16,7	BA2326	23915	17,8	BA2307	24674	18,0	BA2335
23623	17,4	BA2308	23916	17,8	BA2307	29076	20,0	BA2239
23624	17,4	BA2308	23917	19,0	BA2241	29190	19,6	BA2277
23654	15,2	BA2194	23918	19,0	BA2241	29192	20,9	BA2281
23655	15,2	BA2194	23919	18,3	BA2324	29835	22,0	BA2124
23669	16,8	BA2261	23920	18,3	BA2324			
23706	17,8	BA2283	23921	20,0	BA2323			
23707	17,8	BA2256	23926	17,3	BA2309			
23707	17,8	BA2283	23927	17,3	BA2309			
23708	18,4	BA2289	23930	17,5	BA2230			
23709	19,4	BA2299	23935	17,8	BA2311			
23709	19,4	BA2299	23950	19,6	BA2259			
23710	19,4	BA2299	23959	17,6	BA2296			
23710	19,4	BA2299	23973	17,3	BA2284			
23714	16,3	BA2303	23973	17,3	BA2301			
23716	16,3	BA2272	23980	16,0	BA2247			
23717	16,3	BA2272	23982	17,8	BA2256			
23723	18,4	BA2234	23999	17,8	BA2311			
23724	18,4	BA2234	24007	20,9	BA2263			
23732	17,3	BA2240	24008	17,7	BA2264			
23737	17,3	BA2240	24045	13,1	BA2257			
23743	20,1	BA2221	24077	18,3	BA2266			
23744	20,1	BA2221	24123	20,2	BA2314			
23745	17,7	BA2204	24124	19,2	BA2314			
23746	17,5	BA2242	24137	16,4	BA2235			
23747	17,5	BA2242	24137	16,4	BA2258			
23749	17,0	BA2242	24150	17,6	BA2300			
23762	19,6	BA2246	24260	16,9	BA2287			
23763	19,6	BA2246	24288	17,8	BA2256			
23763	19,6	BA2259	24367	19,1	BA2327			
23766	18,0	BA2270	24368	19,1	BA2327			
23768	18,8	BA2295	24403	17,3	BA2301			
23793	19,6	BA2252	24465	18,3	BA2265			
23794	19,6	BA2252	24466	19,1	BA2328			
23801	19,6	BA2259	24467	19,1	BA2328			
23816	16,1	BA2331	24468	18,5	BA2275			
23818	18,0	BA2270	24469	18,5	BA2275			
23819	18,0	BA2270	24484	18,8	BA2306			
23832	19,7	BA2255	24485	18,8	BA2305			
23833	19,7	BA2255	24486	17,3	BA2304			
23840	18,5	BA2262	24535	18,3	BA2317			
23841	18,5	BA2262	24536	18,3	BA2316			
23842	18,0	BA2334	24537	15,8	BA2313			

# Vergleichsliste Barum → WVA

Liste des correspondances BARUM → WVA / Tabella di conversione codici BARUM → WVA /

Lista de comparação BARUM → WVA / Lista porównawcza numerów BARUM → WVA /

Porovnávací seznam čísel BARUM → WVA

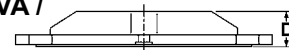

Barum	WVA	D	Barum	WVA	D	Barum	WVA	D
BA2010	21515	17,5	BA2037	20168	16,3	BA2074	20905	18,0
BA2010	21516	17,5	BA2038	20168	19,6	BA2074	20906	18,0
BA2010	21517	17,5	BA2039	20861	17,5	BA2075	20634	15,0
BA2011	21518	17,0	BA2040	21170	17,0	BA2076	20973	11,0
BA2012	21520	17,5	BA2041	20166	16,0	BA2076	20974	11,0
BA2012	21521	17,5	BA2043	21209	18,5	BA2077	20634	15,0
BA2012	21522	17,5	BA2043	21210	18,5	BA2077	21096	15,0
BA2013	20236	18,2	BA2044	21439	20,3	BA2077	21097	15,0
BA2013	20238	18,2	BA2045	21797	19,7	BA2078	21631	17,0
BA2013	20247	18,2	BA2045	21798	19,7	BA2079	23042	18,7
BA2014	21217	17,5	BA2046	21799	19,7	BA2080	21469	19,0
BA2015	21724	18,2	BA2046	21800	19,7	BA2081	21470	19,0
BA2015	21749	18,2	BA2047	21801	19,0	BA2082	20336	14,0
BA2016	21674	19,3	BA2047	21802	19,0	BA2082	20337	14,0
BA2017	20961	17,2	BA2048	21460	18,2	BA2083	20905	18,0
BA2018	21945	16,3	BA2048	21613	18,2	BA2083	20906	18,0
BA2019	20380	15,6	BA2049	21479	19,2	BA2084	21171	18,0
BA2019	21110	15,6	BA2050	20919	18,3	BA2084	23300	18,0
BA2020	21614	17,5	BA2050	21388	18,3	BA2084	23301	18,0
BA2020	21615	17,5	BA2052	21144	16,6	BA2086	20926	18,5
BA2020	21616	17,5	BA2053	20180	17,3	BA2086	20927	18,5
BA2021	23124	19,0	BA2053	20181	17,3	BA2086	20928	18,5
BA2021	23125	19,0	BA2054	20995	17,3	BA2086	20929	18,5
BA2022	21888	18,0	BA2054	20996	17,3	BA2089	23597	18,0
BA2022	21889	18,0	BA2055	20905	18,0	BA2089	23598	18,0
BA2023	21463	18,0	BA2055	20906	18,0	BA2090	21980	18,0
BA2024	20741	19,2	BA2055	20986	18,0	BA2090	21981	18,0
BA2024	20787	19,2	BA2055	20987	18,0	BA2091	23022	20,9
BA2025	20979	19,7	BA2056	20635	18,0	BA2093	20687	13,5
BA2026	21173	17,0	BA2056	20636	18,0	BA2094	20687	15,5
BA2027	21055	16,9	BA2056	20859	18,0	BA2095	21050	15,7
BA2028	20669	19,6	BA2056	20860	18,0	BA2096	21179	16,8
BA2028	20901	19,6	BA2060	21016	17,0	BA2096	21289	16,8
BA2029	20941	19,3	BA2060	21086	17,0	BA2097	21191	17,0
BA2029	21028	19,3	BA2060	21087	17,0	BA2097	21267	17,0
BA2030	20981	13,7	BA2062	20073	17,3	BA2098	21140	15,7
BA2031	20669	19,6	BA2064	20775	18,0	BA2099	21278	17,0
BA2032	20961	15,2	BA2065	20775	18,0	BA2099	21279	17,0
BA2033	21100	17,0	BA2065	20776	18,0	BA2100	21857	16,8
BA2033	21105	17,0	BA2065	20777	18,0	BA2101	20784	18,0
BA2034	20833	17,1	BA2066	20905	18,0	BA2106	20162	15,4
BA2034	20834	17,1	BA2066	20906	18,0	BA2107	20410	15,0
BA2034	20838	17,1	BA2068	20932	14,0	BA2107	20423	15,0
BA2035	21103	14,4	BA2068	20934	14,0	BA2108	21643	17,8
BA2036	20989	17,5	BA2071	21365	17,0	BA2108	21644	17,8
BA2036	21022	17,5	BA2072	21436	17,0	BA2109	20280	18,5
BA2036	21023	17,5	BA2073	21436	17,0	BA2110	21378	15,0

# Vergleichsliste Barum → WVA

Liste des correspondances BARUM → WVA / Tabella di conversione codici BARUM → WVA /

Lista de comparação BARUM → WVA / Lista porównawcza numerów BARUM → WVA /

Porovnávací seznam čísel BARUM → WVA

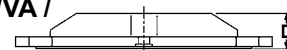

WVA	D	WVA	D	WVA	D
BA2110	21379 16,0	BA2140	21430 17,3	BA2170	21691 17,3
BA2110	21380 16,0	BA2140	21432 17,3	BA2170	21891 17,3
BA2111	21012 15,0	BA2141	20887 17,3	BA2171	21883 19,6
BA2112	21373 16,0	BA2141	20888 17,3	BA2171	21885 19,6
BA2112	21374 16,0	BA2142	21930 17,9	BA2172	20676 20,6
BA2112	21375 16,0	BA2142	21932 17,9	BA2172	23018 20,6
BA2113	21657 16,4	BA2143	21927 17,9	BA2172	23019 20,6
BA2113	21658 16,4	BA2143	21929 17,9	BA2173	23063 17,3
BA2113	21659 16,4	BA2144	20640 18,0	BA2173	23064 17,3
BA2114	21543 16,5	BA2144	20753 18,0	BA2173	23066 18,8
BA2114	21544 16,5	BA2145	21866 19,7	BA2173	23067 18,8
BA2115	21654 15,0	BA2145	21868 19,7	BA2174	21303 18,8
BA2115	21655 15,0	BA2146	21202 17,0	BA2175	21368 18,3
BA2115	21656 15,0	BA2146	21203 17,0	BA2176	23070 17,0
BA2116	21601 17,5	BA2147	21848 19,5	BA2177	23144 19,8
BA2116	21602 17,5	BA2147	21849 19,5	BA2177	23145 19,8
BA2116	21603 17,5	BA2148	20676 20,6	BA2178	20669 16,3
BA2117	21647 16,0	BA2148	21624 20,6	BA2181	20164 18,2
BA2117	21648 16,0	BA2148	21646 20,6	BA2182	21153 17,5
BA2117	21649 16,0	BA2149	21576 20,5	BA2184	23271 17,7
BA2118	21754 15,8	BA2149	21577 20,5	BA2185	20588 16,5
BA2118	21755 15,8	BA2150	21664 19,1	BA2187	21459 18,5
BA2118	21756 15,8	BA2150	21795 19,1	BA2187	21897 18,5
BA2119	21481 15,5	BA2151	21430 17,3	BA2188	20629 20,0
BA2121	20870 15,0	BA2151	21827 17,3	BA2188	20757 20,0
BA2122	23234 16,8	BA2152	21866 17,3	BA2189	20675 17,0
BA2123	23241 15,8	BA2152	21868 17,3	BA2189	20756 17,0
BA2124	29835 22,0	BA2153	21866 15,3	BA2190	21676 20,3
BA2125	20968 20,3	BA2153	21868 15,3	BA2190	23183 20,3
BA2125	21064 20,3	BA2154	23130 19,6	BA2191	23193 16,3
BA2126	20576 15,5	BA2154	23131 19,6	BA2191	23194 16,3
BA2131	20889 17,3	BA2155	23130 19,6	BA2191	23195 17,3
BA2132	20887 19,7	BA2155	23131 19,6	BA2191	23196 17,3
BA2132	20888 19,7	BA2155	23187 19,6	BA2192	23189 16,7
BA2133	20887 15,3	BA2160	21945 19,6	BA2192	23190 16,7
BA2133	20888 15,3	BA2161	21197 15,0	BA2192	23191 16,7
BA2134	20939 15,4	BA2162	21035 15,5	BA2192	23192 16,7
BA2135	20676 19,5	BA2163	21305 15,5	BA2193	20437 19,0
BA2135	20678 19,5	BA2164	21919 15,8	BA2194	23417 15,2
BA2136	20547 16,8	BA2166	21486 19,3	BA2194	23654 15,2
BA2136	21353 16,8	BA2166	21642 19,3	BA2194	23655 15,2
BA2137	21190 17,5	BA2167	21282 17,3	BA2195	23587 19,6
BA2137	21201 17,5	BA2167	21487 17,3	BA2195	23588 19,6
BA2138	21396 18,0	BA2168	21670 20,3	BA2195	23589 19,6
BA2138	21582 18,0	BA2168	21794 20,3	BA2196	23914 16,3
BA2139	21394 18,0	BA2169	21676 19,5	BA2197	23258 16,9
BA2139	21396 18,0	BA2169	21677 19,5	BA2197	23259 16,9

# Vergleichsliste Barum → WVA

Liste des correspondances BARUM → WVA / Tabella di conversione codici BARUM → WVA /

Lista de comparação BARUM → WVA / Lista porównawcza numerów BARUM → WVA /

Porovnávací seznam čísel BARUM → WVA

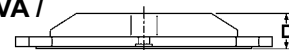

Barum	WVA	D	Barum	WVA	D	Barum	WVA	D
BA2197	23262	16,9	BA2226	21861	15,3	BA2253	23073	18,8
BA2197	23263	16,9	BA2227	21545	14,9	BA2253	23074	18,8
BA2198	21945	19,6	BA2228	20961	17,2	BA2254	23099	18,4
BA2198	23393	19,6	BA2228	23516	17,2	BA2255	23832	19,7
BA2199	23202	18,8	BA2229	23600	19,0	BA2255	23833	19,7
BA2199	23604	18,8	BA2230	23930	17,5	BA2255	23844	19,7
BA2200	23224	16,5	BA2231	23034	19,6	BA2256	23707	17,8
BA2200	23446	16,5	BA2231	23418	19,6	BA2256	23982	17,8
BA2201	21883	19,6	BA2231	23419	19,6	BA2256	24288	17,8
BA2201	21885	19,6	BA2232	21626	15,8	BA2257	24045	13,1
BA2201	23163	19,6	BA2233	21621	17,0	BA2258	23482	16,4
BA2202	23224	16,5	BA2233	21622	17,0	BA2258	24137	16,4
BA2202	23446	16,5	BA2234	23723	18,4	BA2259	23763	19,6
BA2203	23200	18,8	BA2234	23724	18,4	BA2259	23801	19,6
BA2203	23201	18,8	BA2235	23482	16,4	BA2259	23950	19,6
BA2204	23271	17,7	BA2235	24137	16,4	BA2260	23253	15,9
BA2204	23745	17,7	BA2236	23378	20,4	BA2260	23254	15,9
BA2205	20676	19,5	BA2236	23379	20,4	BA2260	23257	15,9
BA2205	21911	20,6	BA2236	23402	20,4	BA2261	23669	16,8
BA2205	23392	20,6	BA2236	23403	20,4	BA2262	23434	18,5
BA2206	21899	15,1	BA2237	21983	17,3	BA2262	23435	18,5
BA2207	21829	20,3	BA2238	23482	16,4	BA2262	23840	18,5
BA2207	23115	20,3	BA2238	23483	16,4	BA2262	23841	18,5
BA2208	23353	15,0	BA2239	29076	20,0	BA2263	24007	20,9
BA2209	23154	19,0	BA2240	23732	17,3	BA2264	24008	17,7
BA2209	23155	19,0	BA2240	23737	17,3	BA2265	24465	18,3
BA2210	23225	17,0	BA2241	23917	19,0	BA2266	24077	18,3
BA2210	23226	17,0	BA2241	23918	19,0	BA2267	23281	18,3
BA2211	23057	19,6	BA2242	23746	17,5	BA2267	23282	18,3
BA2211	23058	19,6	BA2242	23747	17,5	BA2268	21920	15,1
BA2211	23059	19,6	BA2242	23749	17,0	BA2269	21848	19,6
BA2212	23554	16,4	BA2243	23326	17,4	BA2269	21849	19,6
BA2213	21900	15,8	BA2244	21273	19,5	BA2269	23324	20,6
BA2214	23599	19,0	BA2244	21274	19,5	BA2270	23766	18,0
BA2215	21592	18,5	BA2245	23312	19,6	BA2270	23818	18,0
BA2215	21593	18,5	BA2245	23347	19,6	BA2270	23819	18,0
BA2216	23021	18,9	BA2246	23762	19,6	BA2271	23517	16,3
BA2217	21999	15,5	BA2246	23763	19,6	BA2272	23716	16,3
BA2217	23001	15,5	BA2247	23980	16,0	BA2272	23717	16,3
BA2218	23334	16,1	BA2249	21363	16,0	BA2273	23093	16,6
BA2218	23335	16,1	BA2249	21768	16,0	BA2273	23463	16,6
BA2219	23172	18,3	BA2249	21769	16,0	BA2274	21697	15,0
BA2220	23138	14,6	BA2250	21278	17,0	BA2274	21698	15,0
BA2221	23743	20,1	BA2250	21904	17,0	BA2274	21699	15,0
BA2221	23744	20,1	BA2251	23613	17,8	BA2275	24468	18,5
BA2224	23279	18,5	BA2252	23793	19,6	BA2275	24469	18,5
BA2225	23557	17,2	BA2252	23794	19,6	BA2276	21586	15,7



# Vergleichsliste Barum → WVA

Liste des correspondances BARUM → WVA / Tabella di conversione codici BARUM → WVA /

Lista de comparação BARUM → WVA / Lista porównawcza numerów BARUM → WVA /

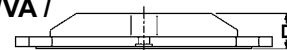
Porovnávací seznam čísel BARUM → WVA





	WVA	D		WVA	D		WVA	D
BA2277	29190	19,6	BA2301	24403	17,3	BA2331	23816	16,1
BA2278	23094	16,5	BA2302	21436	17,0	BA2332	21930	17,9
BA2278	23563	16,5	BA2303	23714	16,3	BA2332	23181	17,9
BA2278	23564	16,5	BA2304	24486	17,3	BA2333	20676	19,8
BA2279	23076	17,2	BA2305	24485	18,8	BA2333	21911	20,3
BA2279	23077	17,2	BA2306	24484	18,8	BA2334	20907	18,0
BA2280	21719	15,0	BA2307	23915	17,8	BA2334	23842	18,0
BA2280	21720	15,0	BA2307	23916	17,8	BA2335	24673	18,0
BA2280	21721	15,0	BA2308	23623	17,4	BA2335	24674	18,0
BA2281	29192	20,9	BA2308	23624	17,4			
BA2282	23407	19,3	BA2309	23926	17,3			
BA2283	23706	17,8	BA2309	23927	17,3			
BA2283	23707	17,8	BA2310	23881	20,1			
BA2284	23973	17,3	BA2311	23935	17,8			
BA2285	20261	19,3	BA2311	23999	17,8			
BA2285	20267	19,3	BA2313	24537	15,8			
BA2286	23410	15,7	BA2314	24123	20,2			
BA2286	23411	15,7	BA2314	24124	19,2			
BA2287	24260	16,9	BA2315	21637	19,3			
BA2288	23245	18,2	BA2315	21641	19,3			
BA2288	23247	18,2	BA2315	23289	19,3			
BA2289	23708	18,4	BA2316	23245	18,3			
BA2290	23020	17,9	BA2316	24536	18,3			
BA2291	23543	15,7	BA2317	23215	18,3			
BA2291	23544	15,7	BA2317	24535	18,3			
BA2291	23545	15,7	BA2318	23269	20,1			
BA2292	21012	15,0	BA2318	23270	20,1			
BA2292	21773	15,0	BA2320	23302	18,0			
BA2292	21774	15,0	BA2321	21479	19,2			
BA2293	23521	14,0	BA2321	23445	19,2			
BA2293	23522	14,0	BA2322	20651	18,2			
BA2293	23523	14,0	BA2322	21635	18,2			
BA2294	23510	16,5	BA2323	23921	20,0			
BA2294	23511	16,5	BA2324	23919	18,3			
BA2294	23512	16,5	BA2324	23920	18,3			
BA2295	23480	18,8	BA2325	21797	19,7			
BA2295	23481	18,8	BA2325	23602	19,7			
BA2295	23768	18,8	BA2326	23620	16,7			
BA2296	23959	17,6	BA2326	23621	16,7			
BA2298	23581	18,8	BA2326	23622	16,7			
BA2298	23843	18,8	BA2327	24367	19,1			
BA2299	23709	19,4	BA2327	24368	19,1			
BA2299	23709	19,4	BA2328	24466	19,1			
BA2299	23710	19,4	BA2328	24467	19,1			
BA2299	23710	19,4	BA2329	24595	18,9			
BA2300	24150	17,6	BA2329	24608	18,9			
BA2301	23973	17,3	BA2330	24578	16,3			

# Vergleichsliste

Liste des correspondances / Tabella di conversione codici / Lista de comparação /

Lista porównawcza numerów / Porovnávací seznam čísel



ATE		ATE		ATE	
03.0137-0126.2	<b>BAE5003</b>	13.0460-2738.2	<b>BA2329</b>	13.0460-2927.2	<b>BA2029</b>
03.0137-0195.2	<b>BAE5014</b>	13.0460-2739.2	<b>BA2330</b>	13.0460-2928.2	<b>BA2030</b>
03.0137-0196.2	<b>BAE5020</b>	13.0460-2803.2	<b>BA2010</b>	13.0460-2934.2	<b>BA2031</b>
03.0137-0209.2	<b>BAE5008</b>	13.0460-2804.2	<b>BA2011</b>	13.0460-2937.2	<b>BA2032</b>
03.0137-0235.2	<b>BAE5021</b>	13.0460-2805.2	<b>BA2012</b>	13.0460-2948.2	<b>BA2033</b>
03.0137-0247.2	<b>BAE5013</b>	13.0460-2810.2	<b>BA2013</b>	13.0460-2949.2	<b>BA2034</b>
03.0137-0253.2	<b>BAE5030</b>	13.0460-2812.2	<b>BA2014</b>	13.0460-2951.2	<b>BA2035</b>
03.0137-0256.2	<b>BAE5024</b>	13.0460-2815.2	<b>BA2175</b>	13.0460-2956.2	<b>BA2036</b>
03.0137-0264.2	<b>BAE5006</b>	13.0460-2816.2	<b>BA2015</b>	13.0460-2957.2	<b>BA2037</b>
03.0137-0266.2	<b>BAE5005</b>	13.0460-2817.2	<b>BA2016</b>	13.0460-2958.2	<b>BA2038</b>
03.0137-0267.2	<b>BAE5011</b>	13.0460-2819.2	<b>BA2017</b>	13.0460-2964.2	<b>BA2039</b>
03.0137-0268.2	<b>BAE5001</b>	13.0460-2820.2	<b>BA2017</b>	13.0460-2965.2	<b>BA2040</b>
03.0137-0272.2	<b>BAE5031</b>	13.0460-2821.2	<b>BA2018</b>	13.0460-2966.2	<b>BA2041</b>
03.0137-0274.2	<b>BAE5016</b>	13.0460-2822.2	<b>BA2160</b>	13.0460-2971.2	<b>BA2043</b>
03.0137-0278.2	<b>BAE5027</b>	13.0460-2823.2	<b>BA2017</b>	13.0460-2973.2	<b>BA2322</b>
03.0137-0312.2	<b>BAE5002</b>	13.0460-2824.2	<b>BA2019</b>	13.0460-2975.2	<b>BA2044</b>
03.0137-0313.2	<b>BAE5035</b>	13.0460-2825.2	<b>BA2020</b>	13.0460-2976.2	<b>BA2045</b>
03.0137-0314.2	<b>BAE5037</b>	13.0460-2829.2	<b>BA2021</b>	13.0460-2977.2	<b>BA2046</b>
03.0137-0322.2	<b>BAE5012</b>	13.0460-2830.2	<b>BA2268</b>	13.0460-2978.2	<b>BA2047</b>
03.0137-0331.2	<b>BAE5034</b>	13.0460-2831.2	<b>BA2226</b>	13.0460-2981.2	<b>BA2048</b>
03.0137-0333.2	<b>BAE5023</b>	13.0460-2832.2	<b>BA2022</b>	13.0460-2982.2	<b>BA2049</b>
03.0137-0334.2	<b>BAE5042</b>	13.0460-2833.2	<b>BA2176</b>	13.0460-2983.2	<b>BA2050</b>
03.0137-0335.2	<b>BAE5022</b>	13.0460-2834.2	<b>BA2023</b>	13.0460-2984.2	<b>BA2017</b>
03.0137-0336.2	<b>BAE5026</b>	13.0460-2835.2	<b>BA2208</b>	13.0460-2985.2	<b>BA2181</b>
03.0137-0337.2	<b>BAE5004</b>	13.0460-2837.2	<b>BA2198</b>	13.0460-3602.2	<b>BA2052</b>
03.0137-0338.2	<b>BAE5015</b>	13.0460-2838.2	<b>BA2321</b>	13.0460-3605.2	<b>BA2053</b>
03.0137-0341.2	<b>BAE5019</b>	13.0460-2840.2	<b>BA2247</b>	13.0460-3800.2	<b>BA2251</b>
03.0137-0345.2	<b>BAE5038</b>	13.0460-2845.2	<b>BA2212</b>	13.0460-3803.2	<b>BA2054</b>
03.0137-0349.2	<b>BAE5007</b>	13.0460-2850.2	<b>BA2325</b>	13.0460-3805.2	<b>BA2161</b>
03.0137-0350.2	<b>BAE5017</b>	13.0460-2853.2	<b>BA2237</b>	13.0460-3806.2	<b>BA2261</b>
03.0137-0352.2	<b>BAE5029</b>	13.0460-2855.2	<b>BA2220</b>	13.0460-3807.2	<b>BA2072</b>
03.0137-0356.2	<b>BAE5041</b>	13.0460-2857.2	<b>BA2210</b>	13.0460-3811.2	<b>BA2289</b>
03.0137-0357.2	<b>BAE5009</b>	13.0460-2859.2	<b>BA2228</b>	13.0460-3813.2	<b>BA2300</b>
03.0137-0360.2	<b>BAE5010</b>	13.0460-2863.2	<b>BA2285</b>	13.0460-3815.2	<b>BA2230</b>
03.0137-0393.2	<b>BAE5040</b>	13.0460-2867.2	<b>BA2271</b>	13.0460-3819.2	<b>BA2263</b>
03.0137-0394.2	<b>BAE5036</b>	13.0460-2868.2	<b>BA2194</b>	13.0460-3821.2	<b>BA2264</b>
03.0137-0396.2	<b>BAE5025</b>	13.0460-2870.2	<b>BA2254</b>	13.0460-3826.2	<b>BA2283</b>
03.0137-0411.2	<b>BAE5028</b>	13.0460-2871.2	<b>BA2282</b>	13.0460-3829.2	<b>BA2296</b>
03.0137-0412.2	<b>BAE5039</b>	13.0460-2872.2	<b>BA2200</b>	13.0460-3831.2	<b>BA2287</b>
03.0137-0424.2	<b>BAE5033</b>	13.0460-2874.2	<b>BA2202</b>	13.0460-3832.2	<b>BA2277</b>
03.0137-0427.2	<b>BAE5018</b>	13.0460-2880.2	<b>BA2196</b>	13.0460-3833.2	<b>BA2305</b>
03.0137-0432.2	<b>BAE5032</b>	13.0460-2882.2	<b>BA2243</b>	13.0460-3834.2	<b>BA2306</b>
03.3214-0812.3	<b>BAW1401</b>	13.0460-2884.2	<b>BA2298</b>	13.0460-3835.2	<b>BA2304</b>
03.3215-2311.3	<b>BAW1501</b>	13.0460-2885.2	<b>BA2266</b>	13.0460-3837.2	<b>BA2277</b>
03.3217-2112.3	<b>BAW1701</b>	13.0460-2886.2	<b>BA2032</b>	13.0460-3838.2	<b>BA2302</b>
03.3217-3512.3	<b>BAW1705</b>	13.0460-2887.2	<b>BA2196</b>	13.0460-3839.2	<b>BA2256</b>
03.3219-6311.3	<b>BAW1904</b>	13.0460-2894.2	<b>BA2017</b>	13.0460-3911.2	<b>BA2055</b>
13.0460-2708.2	<b>BA2310</b>	13.0460-2895.2	<b>BA2219</b>	13.0460-3915.2	<b>BA2056</b>
13.0460-2709.2	<b>BA2284</b>	13.0460-2896.2	<b>BA2268</b>	13.0460-3933.2	<b>BA2060</b>
13.0460-2710.2	<b>BA2307</b>	13.0460-2897.2	<b>BA2226</b>	13.0460-3936.2	<b>BA2062</b>
13.0460-2711.2	<b>BA2266</b>	13.0460-2901.2	<b>BA2024</b>	13.0460-3939.2	<b>BA2064</b>
13.0460-2712.2	<b>BA2220</b>	13.0460-2903.2	<b>BA2025</b>	13.0460-3940.2	<b>BA2065</b>
13.0460-2713.2	<b>BA2308</b>	13.0460-2921.2	<b>BA2026</b>	13.0460-3943.2	<b>BA2066</b>
13.0460-2723.2	<b>BA2313</b>	13.0460-2923.2	<b>BA2027</b>	13.0460-3945.2	<b>BA2068</b>
13.0460-2726.2	<b>BA2177</b>	13.0460-2925.2	<b>BA2028</b>	13.0460-3946.2	<b>BA2320</b>
13.0460-2727.2	<b>BA2177</b>	13.0460-2926.2	<b>BA2178</b>	13.0460-3949.2	<b>BA2071</b>



# Vergleichsliste

Liste des correspondances / Tabella di conversione codici / Lista de comparação /



Lista porównawcza numerów / Porovnávací seznam čísel

ATE		ATE		ATE	
13.0460-3950.2	<b>BA2072</b>	13.0460-4979.2	<b>BA2324</b>	13.0460-7064.2	<b>BA2142</b>
13.0460-3951.2	<b>BA2073</b>	13.0460-4980.2	<b>BA2323</b>	13.0460-7065.2	<b>BA2143</b>
13.0460-3952.2	<b>BA2074</b>	13.0460-4984.2	<b>BA2184</b>	13.0460-7071.2	<b>BA2144</b>
13.0460-3953.2	<b>BA2075</b>	13.0460-4990.2	<b>BA2204</b>	13.0460-7072.2	<b>BA2145</b>
13.0460-3954.2	<b>BA2076</b>	13.0460-5032.2	<b>BA2185</b>	13.0460-7073.2	<b>BA2146</b>
13.0460-3955.2	<b>BA2077</b>	13.0460-5405.2	<b>BA2108</b>	13.0460-7076.2	<b>BA2147</b>
13.0460-3956.2	<b>BA2078</b>	13.0460-5700.2	<b>BA2301</b>	13.0460-7077.2	<b>BA2148</b>
13.0460-3957.2	<b>BA2079</b>	13.0460-5701.2	<b>BA2109</b>	13.0460-7078.2	<b>BA2166</b>
13.0460-3959.2	<b>BA2080</b>	13.0460-5801.2	<b>BA2284</b>	13.0460-7079.2	<b>BA2167</b>
13.0460-3960.2	<b>BA2081</b>	13.0460-5804.2	<b>BA2257</b>	13.0460-7081.2	<b>BA2333</b>
13.0460-3961.2	<b>BA2082</b>	13.0460-5807.2	<b>BA2273</b>	13.0460-7083.2	<b>BA2233</b>
13.0460-3962.2	<b>BA2083</b>	13.0460-5810.2	<b>BA2294</b>	13.0460-7084.2	<b>BA2215</b>
13.0460-3963.2	<b>BA2276</b>	13.0460-5812.2	<b>BA2293</b>	13.0460-7085.2	<b>BA2250</b>
13.0460-3964.2	<b>BA2286</b>	13.0460-5813.2	<b>BA2295</b>	13.0460-7086.2	<b>BA2150</b>
13.0460-3965.2	<b>BA2084</b>	13.0460-5814.2	<b>BA2326</b>	13.0460-7087.2	<b>BA2168</b>
13.0460-3966.2	<b>BA2229</b>	13.0460-5815.2	<b>BA2270</b>	13.0460-7088.2	<b>BA2151</b>
13.0460-3969.2	<b>BA2086</b>	13.0460-5819.2	<b>BA2331</b>	13.0460-7089.2	<b>BA2169</b>
13.0460-3975.2	<b>BA2089</b>	13.0460-5825.2	<b>BA2278</b>	13.0460-7090.2	<b>BA2170</b>
13.0460-3976.2	<b>BA2197</b>	13.0460-5833.2	<b>BA2291</b>	13.0460-7091.2	<b>BA2207</b>
13.0460-3977.2	<b>BA2090</b>	13.0460-5872.2	<b>BA2292</b>	13.0460-7100.2	<b>BA2152</b>
13.0460-3979.2	<b>BA2217</b>	13.0460-5929.2	<b>BA2280</b>	13.0460-7101.2	<b>BA2153</b>
13.0460-3980.2	<b>BA2091</b>	13.0460-5932.2	<b>BA2110</b>	13.0460-7102.2	<b>BA2171</b>
13.0460-3983.2	<b>BA2299</b>	13.0460-5936.2	<b>BA2111</b>	13.0460-7110.2	<b>BA2172</b>
13.0460-3985.2	<b>BA2290</b>	13.0460-5940.2	<b>BA2112</b>	13.0460-7111.2	<b>BA2154</b>
13.0460-3987.2	<b>BA2224</b>	13.0460-5941.2	<b>BA2113</b>	13.0460-7114.2	<b>BA2332</b>
13.0460-3988.2	<b>BA2225</b>	13.0460-5942.2	<b>BA2114</b>	13.0460-7115.2	<b>BA2173</b>
13.0460-3990.2	<b>BA2216</b>	13.0460-5943.2	<b>BA2274</b>	13.0460-7116.2	<b>BA2211</b>
13.0460-3991.2	<b>BA2303</b>	13.0460-5944.2	<b>BA2115</b>	13.0460-7117.2	<b>BA2155</b>
13.0460-3992.2	<b>BA2262</b>	13.0460-5951.2	<b>BA2116</b>	13.0460-7121.2	<b>BA2209</b>
13.0460-3994.2	<b>BA2214</b>	13.0460-5952.2	<b>BA2117</b>	13.0460-7122.2	<b>BA2205</b>
13.0460-3995.2	<b>BA2260</b>	13.0460-5954.2	<b>BA2118</b>	13.0460-7124.2	<b>BA2201</b>
13.0460-3999.2	<b>BA2221</b>	13.0460-5956.2	<b>BA2232</b>	13.0460-7135.2	<b>BA2279</b>
13.0460-4030.2	<b>BA2093</b>	13.0460-5958.2	<b>BA2249</b>	13.0460-7137.2	<b>BA2238</b>
13.0460-4034.2	<b>BA2094</b>	13.0460-5959.2	<b>BA2119</b>	13.0460-7140.2	<b>BA2315</b>
13.0460-4036.2	<b>BA2162</b>	13.0460-5976.2	<b>BA2121</b>	13.0460-7141.2	<b>BA2334</b>
13.0460-4040.2	<b>BA2095</b>	13.0460-5986.2	<b>BA2227</b>	13.0460-7142.2	<b>BA2199</b>
13.0460-4041.2	<b>BA2096</b>	13.0460-5994.2	<b>BA2122</b>	13.0460-7143.2	<b>BA2269</b>
13.0460-4042.2	<b>BA2097</b>	13.0460-5996.2	<b>BA2123</b>	13.0460-7145.2	<b>BA2253</b>
13.0460-4043.2	<b>BA2098</b>	13.0460-6015.2	<b>BA2124</b>	13.0460-7148.2	<b>BA2203</b>
13.0460-4044.2	<b>BA2162</b>	13.0460-6033.2	<b>BA2125</b>	13.0460-7153.2	<b>BA2318</b>
13.0460-4047.2	<b>BA2163</b>	13.0460-6909.2	<b>BA2126</b>	13.0460-7154.2	<b>BA2231</b>
13.0460-4059.2	<b>BA2099</b>	13.0460-6916.2	<b>BA2187</b>	13.0460-7155.2	<b>BA2190</b>
13.0460-4060.2	<b>BA2213</b>	13.0460-7030.2	<b>BA2131</b>	13.0460-7158.2	<b>BA2288</b>
13.0460-4064.2	<b>BA2164</b>	13.0460-7032.2	<b>BA2132</b>	13.0460-7160.2	<b>BA2238</b>
13.0460-4065.2	<b>BA2206</b>	13.0460-7033.2	<b>BA2133</b>	13.0460-7161.2	<b>BA2267</b>
13.0460-4066.2	<b>BA2100</b>	13.0460-7046.2	<b>BA2188</b>	13.0460-7162.2	<b>BA2272</b>
13.0460-4201.2	<b>BA2182</b>	13.0460-7047.2	<b>BA2189</b>	13.0460-7166.2	<b>BA2246</b>
13.0460-4401.2	<b>BA2101</b>	13.0460-7048.2	<b>BA2134</b>	13.0460-7167.2	<b>BA2245</b>
13.0460-4807.2	<b>BA2275</b>	13.0460-7050.2	<b>BA2135</b>	13.0460-7171.2	<b>BA2218</b>
13.0460-4809.2	<b>BA2275</b>	13.0460-7051.2	<b>BA2136</b>	13.0460-7172.2	<b>BA2236</b>
13.0460-4810.2	<b>BA2328</b>	13.0460-7052.2	<b>BA2137</b>	13.0460-7174.2	<b>BA2240</b>
13.0460-4812.2	<b>BA2265</b>	13.0460-7053.2	<b>BA2244</b>	13.0460-7176.2	<b>BA2252</b>
13.0460-4826.2	<b>BA2281</b>	13.0460-7056.2	<b>BA2138</b>	13.0460-7179.2	<b>BA2255</b>
13.0460-4956.2	<b>BA2106</b>	13.0460-7057.2	<b>BA2139</b>	13.0460-7184.2	<b>BA2195</b>
13.0460-4957.2	<b>BA2107</b>	13.0460-7058.2	<b>BA2140</b>	13.0460-7193.2	<b>BA2234</b>
13.0460-4978.2	<b>BA2241</b>	13.0460-7059.2	<b>BA2141</b>	13.0460-7194.2	<b>BA2235</b>

# Vergleichsliste

Liste des correspondances / Tabella di conversione codici / Lista de comparação /



Lista porównawcza numerów / Porovnávací seznam čísel

ATE		ATE		ATE	
13.0460-7195.2	<b>BA2258</b>	24.0110-0223.1	<b>BAR10223</b>	24.0113-0194.1	<b>BAR13194</b>
13.0460-7196.2	<b>BA2149</b>	24.0110-0224.1	<b>BAR10224</b>	24.0115-0105.1	<b>BAR15105</b>
13.0460-7201.2	<b>BA2259</b>	24.0110-0225.1	<b>BAR10225</b>	24.0116-0100.1	<b>BAR16100</b>
13.0460-7209.2	<b>BA2235</b>	24.0110-0226.1	<b>BAR10226</b>	24.0116-0105.1	<b>BAR16105</b>
13.0460-7215.2	<b>BA2311</b>	24.0110-0227.1	<b>BAR10227</b>	24.0116-0110.1	<b>BAR16110</b>
13.0460-7216.2	<b>BA2252</b>	24.0110-0228.1	<b>BAR10228</b>	24.0118-0105.1	<b>BAR18105</b>
13.0460-7217.2	<b>BA2309</b>	24.0110-0229.1	<b>BAR10229</b>	24.0118-0106.1	<b>BAR18106</b>
13.0460-7218.2	<b>BA2327</b>	24.0110-0230.1	<b>BAR10230</b>	24.0118-0107.1	<b>BAR18107</b>
13.0460-7221.2	<b>BA2317</b>	24.0110-0232.1	<b>BAR10232</b>	24.0118-0108.1	<b>BAR18108</b>
13.0460-7222.2	<b>BA2316</b>	24.0110-0250.1	<b>BAR10250</b>	24.0118-0111.1	<b>BAR18111</b>
13.0460-7228.2	<b>BA2314</b>	24.0110-0251.1	<b>BAR10251</b>	24.0118-0113.1	<b>BAR18113</b>
13.0460-7236.2	<b>BA2242</b>	24.0110-0258.1	<b>BAR10258</b>	24.0118-0124.1	<b>BAR18124</b>
13.0460-7240.2	<b>BA2242</b>	24.0110-0259.1	<b>BAR10259</b>	24.0118-0137.1	<b>BAR18137</b>
13.0460-7251.2	<b>BA2235</b>	24.0110-0260.1	<b>BAR10260</b>	24.0119-0107.1	<b>BAR19107</b>
13.0460-7253.2	<b>BA2235</b>	24.0110-0261.1	<b>BAR10261</b>	24.0119-0108.1	<b>BAR19108</b>
13.0460-7270.2	<b>BA2335</b>	24.0110-0273.1	<b>BAR10273</b>	24.0119-0109.1	<b>BAR19109</b>
13.0460-7909.2	<b>BA2239</b>	24.0110-0278.1	<b>BAR10278</b>	24.0120-0114.2	<b>BAR20114</b>
13.0460-8004.2	<b>BA2191</b>	24.0110-0280.1	<b>BAR10280</b>	24.0120-0115.1	<b>BAR20115</b>
13.0460-8005.2	<b>BA2192</b>	24.0110-0285.1	<b>BAR10285</b>	24.0120-0123.1	<b>BAR20123</b>
13.0460-9031.2	<b>BA2193</b>	24.0110-0304.1	<b>BAR10304</b>	24.0120-0125.1	<b>BAR20125</b>
13.0460-9033.2	<b>BA2174</b>	24.0111-0115.1	<b>BAR11115</b>	24.0120-0126.1	<b>BAR20126</b>
24.0108-0104.1	<b>BAR08104</b>	24.0111-0119.1	<b>BAR11119</b>	24.0120-0128.1	<b>BAR20128</b>
24.0108-0106.1	<b>BAR08106</b>	24.0111-0137.1	<b>BAR11137</b>	24.0120-0132.1	<b>BAR20132</b>
24.0108-0107.1	<b>BAR08107</b>	24.0111-0151.1	<b>BAR11151</b>	24.0120-0133.1	<b>BAR20133</b>
24.0108-0111.1	<b>BAR08111</b>	24.0111-0152.1	<b>BAR11152</b>	24.0120-0142.1	<b>BAR20142</b>
24.0109-0114.1	<b>BAR09114</b>	24.0112-0106.1	<b>BAR12106</b>	24.0120-0147.1	<b>BAR20147</b>
24.0109-0118.1	<b>BAR09118</b>	24.0112-0116.1	<b>BAR12116</b>	24.0120-0154.1	<b>BAR20154</b>
24.0109-0120.1	<b>BAR09120</b>	24.0112-0117.1	<b>BAR12117</b>	24.0120-0155.1	<b>BAR20155</b>
24.0109-0122.1	<b>BAR09122</b>	24.0112-0124.1	<b>BAR12124</b>	24.0120-0171.1	<b>BAR20171</b>
24.0109-0123.1	<b>BAR09123</b>	24.0112-0125.1	<b>BAR12125</b>	24.0120-0174.1	<b>BAR20174</b>
24.0109-0124.1	<b>BAR09124</b>	24.0112-0126.1	<b>BAR12126</b>	24.0120-0183.1	<b>BAR20183</b>
24.0109-0133.1	<b>BAR09133</b>	24.0112-0127.1	<b>BAR12127</b>	24.0121-0105.1	<b>BAR21105</b>
24.0109-0136.1	<b>BAR09136</b>	24.0112-0128.1	<b>BAR12128</b>	24.0121-0106.1	<b>BAR21106</b>
24.0109-0137.1	<b>BAR09137</b>	24.0112-0131.1	<b>BAR12131</b>	24.0122-0100.1	<b>BAR22100</b>
24.0109-0138.1	<b>BAR09138</b>	24.0112-0132.1	<b>BAR12132</b>	24.0122-0103.1	<b>BAR22103</b>
24.0109-0139.1	<b>BAR09139</b>	24.0112-0137.1	<b>BAR12137</b>	24.0122-0108.1	<b>BAR22108</b>
24.0110-0111.1	<b>BAR10111</b>	24.0112-0138.1	<b>BAR12138</b>	24.0122-0115.1	<b>BAR22115</b>
24.0110-0115.1	<b>BAR10115</b>	24.0112-0141.1	<b>BAR12141</b>	24.0122-0118.1	<b>BAR22118</b>
24.0110-0151.1	<b>BAR10151</b>	24.0112-0142.1	<b>BAR12142</b>	24.0122-0122.1	<b>BAR22122</b>
24.0110-0152.1	<b>BAR10152</b>	24.0112-0144.1	<b>BAR12144</b>	24.0122-0132.1	<b>BAR22132</b>
24.0110-0178.1	<b>BAR10178</b>	24.0112-0149.1	<b>BAR12149</b>	24.0122-0139.1	<b>BAR22139</b>
24.0110-0185.1	<b>BAR10185</b>	24.0112-0154.1	<b>BAR12154</b>	24.0122-0147.1	<b>BAR22147</b>
24.0110-0187.1	<b>BAR10187</b>	24.0112-0157.1	<b>BAR12157</b>	24.0122-0148.1	<b>BAR22148</b>
24.0110-0189.1	<b>BAR10189</b>	24.0112-0158.1	<b>BAR12158</b>	24.0122-0150.1	<b>BAR22150</b>
24.0110-0191.1	<b>BAR10191</b>	24.0112-0169.1	<b>BAR12169</b>	24.0122-0151.1	<b>BAR22151</b>
24.0110-0196.1	<b>BAR10196</b>	24.0112-0171.1	<b>BAR12171</b>	24.0122-0152.1	<b>BAR22152</b>
24.0110-0201.1	<b>BAR10201</b>	24.0112-0184.1	<b>BAR12184</b>	24.0122-0158.1	<b>BAR22158</b>
24.0110-0202.1	<b>BAR10202</b>	24.0113-0137.1	<b>BAR13137</b>	24.0122-0159.1	<b>BAR22159</b>
24.0110-0203.1	<b>BAR10203</b>	24.0113-0160.1	<b>BAR13160</b>	24.0122-0160.1	<b>BAR22160</b>
24.0110-0204.1	<b>BAR10204</b>	24.0113-0161.1	<b>BAR13161</b>	24.0122-0161.1	<b>BAR22161</b>
24.0110-0205.1	<b>BAR10205</b>	24.0113-0166.1	<b>BAR13166</b>	24.0122-0162.1	<b>BAR22162</b>
24.0110-0210.1	<b>BAR10210</b>	24.0113-0167.1	<b>BAR13167</b>	24.0122-0163.1	<b>BAR22163</b>
24.0110-0211.1	<b>BAR10211</b>	24.0113-0178.1	<b>BAR13178</b>	24.0122-0166.1	<b>BAR22166</b>
24.0110-0215.1	<b>BAR10215</b>	24.0113-0182.1	<b>BAR13182</b>	24.0122-0168.1	<b>BAR22168</b>
24.0110-0217.1	<b>BAR10217</b>	24.0113-0184.1	<b>BAR13184</b>	24.0122-0172.1	<b>BAR22172</b>
24.0110-0219.1	<b>BAR10219</b>	24.0113-0185.1	<b>BAR13185</b>	24.0122-0194.1	<b>BAR22194</b>

# Vergleichsliste

Liste des correspondances / Tabella di conversione codici / Lista de comparação /



Lista porównawcza numerów / Porovnávací seznam čísel

ATE		ATE		ATE	
24.0122-0196.1	BAR22196	24.0126-0109.1	BAR26109	24.3222-1117.3	BAW2201
24.0122-0197.1	BAR22197	24.0126-0115.1	BAR26115	24.3222-1616.3	BAW2202
24.0122-0206.1	BAR22206	24.0126-0116.1	BAR26116	24.3222-1711.3	BAW2205
24.0122-0209.1	BAR22209	24.0126-0120.1	BAR26120	24.3222-1716.3	BAW2207
24.0122-0210.1	BAR22210	24.0126-0122.1	BAR26122	24.3222-1721.3	BAW2204
24.0122-0211.1	BAR22211	24.0126-0138.1	BAR26138	24.3222-1722.3	BAW2206
24.0122-0245.1	BAR22245	24.0128-0101.1	BAR28101	24.3223-1601.3	BAW2301
24.0124-0103.1	BAR24103	24.0128-0102.1	BAR28102	24.3225-1101.3	BAW2501
24.0124-0111.1	BAR24111	24.0128-0104.1	BAR28104	24.3225-1103.3	BAW2500
24.0124-0112.1	BAR24112	24.0128-0106.1	BAR28106	24.3226-1702.3	BAW2600
24.0124-0115.1	BAR24115	24.0128-0123.1	BAR28123	24.3228-1701.3	BAW2800
24.0124-0118.1	BAR24118	24.0128-0129.1	BAR28129	24.5111-0241.3	BAH0024
24.0124-0120.1	BAR24120	24.0128-0132.1	BAR28132	24.5111-0306.3	BAH0031
24.0124-0127.1	BAR24127	24.0128-0136.1	BAR28136	24.5302-0295.3	BAH0030
24.0124-0128.1	BAR24128	24.0128-0140.1	BAR28140	24.5303-0400.3	BAH0032
24.0124-0129.1	BAR24129	24.0128-0141.1	BAR28141	24.5305-0295.3	BAH0029
24.0124-0131.1	BAR24131	24.0128-0142.1	BAR28142	24.8190-0201.2	BAV1002
24.0124-0132.1	BAR24132	24.0128-0176.1	BAR28176	24.8190-0206.2	BAV1005
24.0124-0136.1	BAR24136	24.0130-0101.1	BAR30101	24.8190-0207.2	BAV1006
24.0124-0138.1	BAR24138	24.0130-0107.1	BAR30107	24.8190-0208.2	BAV1036
24.0124-0139.1	BAR24139	24.0130-0109.1	BAR30109	24.8190-0210.2	BAV1031
24.0124-0146.1	BAR24146	24.0130-0113.1	BAR30113	24.8190-0211.2	BAV1011
24.0124-0152.1	BAR24152	24.0130-0173.1	BAR30173	24.8190-0213.2	BAV1007
24.0124-0158.1	BAR24158	24.0132-0115.1	BAR32115	24.8190-0214.2	BAV1003
24.0124-0159.1	BAR24159	24.3214-0902.3	BAW1401	24.8190-0215.2	BAV1035
24.0124-0161.1	BAR24161	24.3215-0903.3	BAW1501	24.8190-0218.2	BAV1010
24.0124-0162.1	BAR24162	24.3217-0908.3	BAW1701	24.8190-0219.2	BAV1009
24.0124-0164.1	BAR24164	24.3217-1708.3	BAW1703	24.8190-0220.2	BAV1012
24.0124-0166.1	BAR24166	24.3217-1709.3	BAW1706	24.8190-0221.2	BAV1013
24.0124-0170.1	BAR24170	24.3217-1710.3	BAW1704	24.8190-0222.2	BAV1015
24.0124-0171.1	BAR24171	24.3217-1711.3	BAW1707	24.8190-0225.2	BAV1018
24.0124-0181.1	BAR24181	24.3217-1715.3	BAW1702	24.8190-0226.2	BAV1019
24.0124-0192.1	BAR24192	24.3219-0803.3	BAW1902	24.8190-0227.2	BAV1021
24.0125-0105.1	BAR25105	24.3219-0909.3	BAW1905	24.8190-0230.2	BAV1022
24.0125-0110.1	BAR25110	24.3219-1107.3	BAW1901	24.8190-0231.2	BAV1037
24.0125-0113.1	BAR25113	24.3219-1603.3	BAW1909	24.8190-0235.2	BAV1038
24.0125-0114.1	BAR25114	24.3219-1604.3	BAW1910	24.8190-0236.2	BAV1039
24.0125-0115.1	BAR25115	24.3219-1609.3	BAW1913	24.8190-0264.2	BAV1042
24.0125-0119.1	BAR25119	24.3219-1610.3	BAW1912	24.8190-0265.2	BAV1043
24.0125-0123.1	BAR25123	24.3219-1704.3	BAW1906	24.8190-0273.2	BAV1025
24.0125-0124.1	BAR25124	24.3219-1717.3	BAW1903	24.8190-0274.2	BAV1040
24.0125-0131.1	BAR25131	24.3219-1722.3	BAW1907	24.8190-0275.2	BAV1041
24.0125-0137.1	BAR25137	24.3219-1728.3	BAW1908	24.8190-0277.2	BAV1044
24.0125-0138.1	BAR25138	24.3219-1735.3	BAW1914	24.8190-0278.2	BAV1045
24.0125-0141.1	BAR25141	24.3219-1743.3	BAW1911	24.8190-0401.2	BAV1004
24.0125-0142.1	BAR25142	24.3220-0909.3	BAW2004	24.8190-0402.2	BAV1001
24.0125-0145.1	BAR25145	24.3220-0910.3	BAW2002	24.8190-0406.2	BAV1032
24.0125-0148.1	BAR25148	24.3220-1107.3	BAW2003	24.8190-0407.2	BAV1008
24.0125-0158.1	BAR25158	24.3220-1108.3	BAW2009	24.8190-0410.2	BAV1046
24.0125-0162.1	BAR25162	24.3220-1112.3	BAW2007	24.8190-0411.2	BAV1047
24.0125-0171.1	BAR25171	24.3220-1116.3	BAW2008	24.8190-0412.2	BAV1024
24.0126-0102.1	BAR26102	24.3220-1121.3	BAW2010	24.8190-0415.2	BAV1033
24.0126-0104.1	BAR26104	24.3220-1623.3	BAW2005	24.8190-0416.2	BAV1023
24.0126-0105.1	BAR26105	24.3220-1624.3	BAW2006	24.8190-0417.2	BAV1026
24.0126-0106.1	BAR26106	24.3220-1711.3	BAW2001	24.8190-0423.2	BAV1034
24.0126-0108.1	BAR26108	24.3222-1114.3	BAW2203	24.8190-0705.2	BAV1028

# Vergleichsliste

Liste des correspondances / Tabella di conversione codici / Lista de comparação /



Lista porównawcza numerów / Porovnávací seznam čísel

ATE		AUDI		AUDI	
24.8190-0706.2	<b>BAV1029</b>	171 698 151 F	<b>BA2132</b>	1H0 698 525 V	<b>BAE5001</b>
24.8190-0707.2	<b>BAV1027</b>	171 698 151 G	<b>BA2132</b>	1H0 698 525 X	<b>BAE5001</b>
24.8190-0710.2	<b>BAV1049</b>	175 611 701 A	<b>BAH0010</b>	1HM 698 151	<b>BA2018</b>
24.8190-0711.2	<b>BAV1017</b>	175 615 301	<b>BAR12106</b>	1HM 698 151 A	<b>BA2018</b>
24.8190-0714.2	<b>BAV1016</b>	175 698 151	<b>BA2132</b>	1J0 609 525	<b>BAE5009</b>
24.8190-0715.2	<b>BAV1030</b>	176 698 151	<b>BA2132</b>	1J0 609 526	<b>BAE5009</b>
24.8190-0718.2	<b>BAV1014</b>	191 611 701	<b>BAH0010</b>	1J0 609 527	<b>BAE5009</b>
24.8190-0719.2	<b>BAV1020</b>	191 615 601	<b>BAR10111</b>	1J0 609 528	<b>BAE5009</b>
24.8190-0921.2	<b>BAV1050</b>	191 615 601 B	<b>BAR10111</b>	1J0 611 701	<b>BAH0023</b>
24.8190-0922.2	<b>BAV1051</b>	191 698 151	<b>BA2131</b>	1J0 611 701 L	<b>BAH0023</b>
24.8190-0929.2	<b>BAV1052</b>	191 698 151 A	<b>BA2131</b>	1J0 611 775	<b>BAH0033</b>
24.8190-0930.2	<b>BAV1053</b>	191 698 151 B	<b>BA2133</b>	1J0 615 301 C	<b>BAR25113</b>
24.8190-1304.2	<b>BAV1054</b>	191 698 151 C	<b>BA2132</b>	1J0 615 301 D	<b>BAR22151</b>
24.8190-1305.2	<b>BAV1055</b>	191 698 151 D	<b>BA2132</b>	1J0 615 301 E	<b>BAR22150</b>
24.8190-1306.2	<b>BAV1056</b>	191 698 151 E	<b>BA2131</b>	1J0 615 301 K	<b>BAR25113</b>
83.6113-0276.3	<b>BAH0025</b>	191 698 151 F	<b>BA2131</b>	1J0 615 301 L	<b>BAR22151</b>
83.6115-0480.3	<b>BAH0028</b>	191 698 151 G	<b>BA2133</b>	1J0 615 301 M	<b>BAR22150</b>
83.6150-0426.3	<b>BAH0001</b>	191 698 151 H	<b>BA2132</b>	1J0 615 301 P	<b>BAR22150</b>
83.6152-0406.3	<b>BAH0017</b>	191 698 151 J	<b>BA2132</b>	1J0 615 301 R	<b>BAR25113</b>
83.6213-0340.3	<b>BAH0022</b>	191 698 151 K	<b>BA2132</b>	1J0 615 301 S	<b>BAR25113</b>
83.6219-0455.3	<b>BAH0027</b>	191 698 451	<b>BA2032</b>	1J0 615 601	<b>BAR09123</b>
83.7213-0307.3	<b>BAH0021</b>	191 698 451 A	<b>BA2032</b>	1J0 615 601 C	<b>BAR09123</b>
83.7704-0160.3	<b>BAH0003</b>	191 698 451 B	<b>BA2032</b>	1J0 615 601 D	<b>BAR09133</b>
83.7704-0281.3	<b>BAH0004</b>	191 698 451 C	<b>BA2032</b>	1J0 698 151	<b>BA2154</b>
83.7705-0386.3	<b>BAH0018</b>	191 698 451 D	<b>BA2032</b>	1J0 698 151 A	<b>BA2154</b>
83.7713-0435.3	<b>BAH0005</b>	1E0 698 451	<b>BA2017</b>	1J0 698 151 B	<b>BA2154</b>
83.7715-0280.3	<b>BAH0006</b>	1E0 698 451 A	<b>BA2032</b>	1J0 698 151 C	<b>BA2154</b>
83.7716-0363.3	<b>BAH0020</b>	1E0 698 451 B	<b>BA2017</b>	1J0 698 151 D	<b>BA2155</b>
83.7717-0450.3	<b>BAH0007</b>	1E0 698 451 C	<b>BA2017</b>	1J0 698 151 E	<b>BA2155</b>
83.7734-0290.3	<b>BAH0008</b>	1E0 698 451 D	<b>BA2017</b>	1J0 698 151 F	<b>BA2155</b>
83.7754-0340.3	<b>BAH0009</b>	1E0 698 451 E	<b>BA2017</b>	1J0 698 151 G	<b>BA2155</b>
83.7775-0312.3	<b>BAH0010</b>	1E0 698 451 G	<b>BA2017</b>	1J0 698 151 J	<b>BA2154</b>
83.7804-0160.3	<b>BAH0011</b>	1GD 698 151	<b>BA2132</b>	1J0 698 151 K	<b>BA2205</b>
83.7813-0270.3	<b>BAH0026</b>	1H0 611 053	<b>BAW1905</b>	1J0 698 151 L	<b>BA2333</b>
83.7813-0285.3	<b>BAH0012</b>	1H0 611 053 A	<b>BAW1501</b>	1J0 698 151 M	<b>BA2205</b>
83.7813-0295.3	<b>BAH0013</b>	1H0 611 053 B	<b>BAW1401</b>	1J0 698 451	<b>BA2017</b>
83.7813-0330.3	<b>BAH0014</b>	1H0 611 701	<b>BAH0005</b>	1J0 698 451 B	<b>BA2017</b>
83.7824-0180.3	<b>BAH0015</b>	1H0 611 701 F	<b>BAH0005</b>	1J0 698 451 C	<b>BA2017</b>
83.7836-0135.3	<b>BAH0016</b>	1H0 611 775	<b>BAH0016</b>	1J0 698 451 D	<b>BA2017</b>
83.7838-0435.3	<b>BAH0023</b>	1H0 615 301	<b>BAR22100</b>	1J0 698 451 E	<b>BA2017</b>
83.7852-0377.3	<b>BAH0019</b>	1H0 615 301 A	<b>BAR22100</b>	1J0 698 451 F	<b>BA2017</b>
83.7858-0140.3	<b>BAH0033</b>	1H0 698 071	<b>BAE5001</b>	1J0 698 451 G	<b>BA2017</b>
		1H0 698 151	<b>BA2132</b>	1J0 698 451 H	<b>BA2017</b>
<b>AUDI</b>		1H0 698 151 A	<b>BA2145</b>	1J0 698 451 J	<b>BA2017</b>
		1H0 698 151 B	<b>BA2153</b>	1J0 698 451 K	<b>BA2032</b>
171 609 525 A	<b>BAE5003</b>	1H0 698 451	<b>BA2017</b>	1J0 698 451 L	<b>BA2032</b>
171 609 526 A	<b>BAE5003</b>	1H0 698 451 A	<b>BA2017</b>	1J0 698 451 N	<b>BA2032</b>
171 609 527 F	<b>BAE5003</b>	1H0 698 451 B	<b>BA2032</b>	1J0 698 451 P	<b>BA2017</b>
171 609 528 F	<b>BAE5003</b>	1H0 698 451 C	<b>BA2032</b>	1J0 698 451 R	<b>BA2017</b>
171 611 051 B	<b>BAW1401</b>	1H0 698 451 D	<b>BA2017</b>	1J0 698 525	<b>BAE5009</b>
171 611 053	<b>BAW1401</b>	1H0 698 451 E	<b>BA2032</b>	1J0 698 525 A	<b>BAE5009</b>
171 611 053 A	<b>BAW1401</b>	1H0 698 451 F	<b>BA2032</b>	1J0 698 525 B	<b>BAE5009</b>
171 611 701 G	<b>BAH0010</b>	1H0 698 451 G	<b>BA2017</b>	1JD 698 451	<b>BA2017</b>
171 611 701 H	<b>BAH0010</b>	1H0 698 451 H	<b>BA2032</b>	1K0 615 301 AA	<b>BAR25158</b>
171 611 701 L	<b>BAH0010</b>	1H0 698 520 V	<b>BAE5001</b>	1K0 615 301 AC	<b>BAR22210</b>
171 611 775	<b>BAH0011</b>	1H0 698 520 X	<b>BAE5001</b>	1K0 615 301 AK	<b>BAR22210</b>

# Vergleichsliste

Liste des correspondances / Tabella di conversione codici / Lista de comparação /



Lista porównawcza numerów / Porovnávací seznam čísel

AUDI		AUDI		AUDI	
1K0 615 301 K	BAR25145	321 611 775	BAH0015	431 615 301	BAR13160
1K0 615 301 S	BAR22210	321 615 301	BAR12106	431 615 301 A	BAR22118
1K0 615 301 T	BAR25145	321 615 301 A	BAR20123	431 698 071 E	BAE5001
1K0 615 601 AC	BAR12158	321 615 301 B	BAR20123	431 698 073 E	BAE5001
1K0 615 601 AD	BAR12169	321 615 301 C	BAR20123	431 698 151 D	BA2031
1K0 615 601 L	BAR12158	321 615 301 D	BAR20128	431 698 151 F	BA2031
1K0 615 601 M	BAR12169	321 698 151	BA2132	431 698 151 G	BA2031
1K0 698 151	BA2195	321 698 151 B	BA2133	433 611 775 A	BAH0015
1K0 698 151 A	BA2155	321 698 151 C	BA2132	437 611 775	BAH0003
1K0 698 151 C	BA2195	321 698 151 D	BA2133	437 698 151	BA2031
1K0 698 151 D	BA2155	321 698 151 E	BA2133	437 698 451	BA2052
1K0 698 151 E	BA2195	321 698 151 F	BA2132	443 609 525 A	BAE5006
1K0 698 151 F	BA2155	321 698 151 G	BA2132	443 609 526 A	BAE5006
1K0 698 151 J	BA2155	321 698 151 H	BA2133	443 609 527 A	BAE5006
1K0 698 451	BA2196	331 611 051 A	BAW1701	443 609 528 A	BAE5006
1K0 698 451 A	BA2017	331 611 053	BAW1701	443 615 301	BAR13160
1K0 698 451 B	BA2196	331 611 053 A	BAW1701	443 615 301 A	BAR22118
1K0 698 451 C	BA2017	357 609 525 C	BAE5006	443 615 301 B	BAR22118
1K0 698 451 D	BA2196	357 609 526 C	BAE5006	443 615 601	BAR10178
1K0 698 451 E	BA2196	357 609 527 E	BAE5006	443 698 151 A	BA2028
1K0 698 451 F	BA2196	357 609 528 E	BAE5006	443 698 151 C	BA2028
1K0 698 451 G	BA2196	357 611 053 B	BAW2004	443 698 151 D	BA2028
1K0 698 451 H	BA2196	357 615 301	BAR13178	443 698 151 F	BA2028
1K0 698 451 J	BA2017	357 615 601	BAR10111	443 698 151 F	BA2031
1K0 698 451 K	BA2196	357 615 601 B	BAR10203	443 698 151 G	BA2028
1K0 698 451 M	BA2017	357 698 151	BA2038	443 698 151 J	BA2028
251 698 151 C	BA2025	357 698 151 A	BA2037	443 698 151 K	BA2028
251 698 151 F	BA2025	357 698 151 B	BA2038	443 698 451	BA2052
281 615 283 A	BAR20114	357 698 151 D	BA2037	443 698 451 A	BA2052
281 698 151	BA2109	357 698 151 E	BA2018	443 698 451 B	BA2052
281 698 151 A	BA2109	357 698 525 CV	BAE5006	443 698 451 C	BA2052
281 698 151 B	BA2109	357 698 525 CX	BAE5006	443 698 525 BV	BAE5006
2D0 611 701 B	BAH0020	357 698 525 V	BAE5001	443 698 525 BX	BAE5006
2D0 615 301 A	BAR22161	357 698 525 X	BAE5001	443 698 525 CX	BAE5006
2D0 615 301 B	BAR22161	3A0 611 053	BAW2004	447 698 451	BA2052
2D0 615 301 C	BAR22161	3A0 611 701	BAH0019	447 698 451 A	BA2052
2D0 615 301 D	BAR22161	3A0 698 151	BA2333	447 698 451 C	BA2052
2D0 615 601	BAR12142	3A0 698 151 A	BA2333	481 611 775	BAH0003
2D0 615 601 A	BAR16110	3B0 615 301 B	BAR25137	481 611 776	BAH0011
2D0 615 601 B	BAR22196	3B0 698 451	BA2017	4A0 611 707	BAH0026
2D0 615 601 C	BAR12142	3B0 698 451 A	BA2017	4A0 615 301 B	BAR15105
2D0 615 601 D	BAR16110	3C0 698 151	BA2195	4A0 615 301 C	BAR25105
2D0 698 151	BA2149	3C0 698 151 A	BA2195	4A0 615 301 D	BAR25105
2D0 698 151 A	BA2239	3C0 698 151 B	BA2195	4A0 615 301 E	BAR25105
2D0 698 151 B	BA2239	3C0 698 151 C	BA2195	4A0 615 601 A	BAR10201
2D0 698 451	BA2215	3C0 698 151 D	BA2195	4A0 698 151	BA2135
2D0 698 451 A	BA2233	3C0 698 451	BA2196	4A0 698 151 C	BA2135
2D0 698 451 B	BA2216	3C0 698 451 A	BA2196	4A0 698 451	BA2052
2D0 698 451 C	BA2233	3C0 698 451 B	BA2196	4B0 615 301 A	BAR25137
2D0 919 351	BAV1008	3C0 698 451 C	BA2196	4B0 615 301 B	BAR25171
2E0 698 151	BA2281	3U0 611 707	BAH0013	4B0 615 601	BAR10258
2E0 698 151 B	BA2281	431 609 525	BAE5006	4B0 615 601 A	BAR10259
2E0 698 451	BA2277	431 609 526	BAE5006	4B0 615 601 B	BAR10260
2E0 906 206 G	BAV1048	431 609 527 E	BAE5006	4B0 698 151	BA2172
321 611 053 A	BAW1701	431 609 528 E	BAE5006	4B0 698 151 A	BA2172
321 611 701 B	BAH0010	431 611 775 A	BAH0015	4B0 698 151 AB	BA2172

# Vergleichsliste

Liste des correspondances / Tabella di conversione codici / Lista de comparação /



Lista porównawcza numerów / Porovnávací seznam čísel

AUDI		AUDI		AUDI	
4B0 698 151 AC	<b>BA2246</b>	6N0 698 151	<b>BA2152</b>	7D0 615 301 B	<b>BAR26115</b>
4B0 698 151 AD	<b>BA2246</b>	6N0 698 151 A	<b>BA2018</b>	7D0 615 301 C	<b>BAR24128</b>
4B0 698 151 AF	<b>BA2172</b>	6N0 698 151 B	<b>BA2018</b>	7D0 615 601	<b>BAR12138</b>
4B0 698 151 B	<b>BA2172</b>	6N0 698 151 C	<b>BA2152</b>	7D0 615 601 A	<b>BAR13194</b>
4B0 698 151 E	<b>BA2172</b>	6Q0 609 525 A	<b>BAE5001</b>	7D0 615 601 B	<b>BAR12138</b>
4B0 698 151 H	<b>BA2172</b>	6Q0 609 525 B	<b>BAE5001</b>	7D0 615 601 C	<b>BAR13194</b>
4B0 698 151 J	<b>BA2172</b>	6Q0 609 526 A	<b>BAE5001</b>	7D0 698 151	<b>BA2171</b>
4B0 698 151 K	<b>BA2172</b>	6Q0 609 526 B	<b>BAE5001</b>	7D0 698 151 B	<b>BA2321</b>
4B0 698 151 M	<b>BA2172</b>	6Q0 609 527 A	<b>BAE5001</b>	7D0 698 151 D	<b>BA2201</b>
4B0 698 151 N	<b>BA2172</b>	6Q0 609 527 B	<b>BAE5001</b>	7D0 698 151 E	<b>BA2171</b>
4B0 698 151 Q	<b>BA2246</b>	6Q0 609 528 A	<b>BAE5001</b>	7D0 698 151 F	<b>BA2201</b>
4B0 698 151 R	<b>BA2246</b>	6Q0 609 528 B	<b>BAE5001</b>	7D0 698 151 G	<b>BA2321</b>
4B0 698 451	<b>BA2017</b>	6Q0 611 053 C	<b>BAW1701</b>	7D0 698 451	<b>BA2202</b>
4B0 698 451 A	<b>BA2017</b>	6Q0 611 775 A	<b>BAH0033</b>	7D0 698 451 A	<b>BA2202</b>
4B0 698 451 B	<b>BA2017</b>	6Q0 611 775 B	<b>BAH0033</b>	7D0 698 451 B	<b>BA2200</b>
4B0 698 451 E	<b>BA2017</b>	6Q0 615 301	<b>BAR18137</b>	7D0 698 451 C	<b>BA2200</b>
4D0 698 451	<b>BA2052</b>	6Q0 615 301 A	<b>BAR18137</b>	7D0 698 451 D	<b>BA2202</b>
4D0 698 451 A	<b>BA2052</b>	6Q0 698 151	<b>BA2154</b>	7D0 698 451 E	<b>BA2202</b>
4D0 698 451 B	<b>BA2052</b>	6Q0 698 151 C	<b>BA2298</b>	7D0 698 451 F	<b>BA2200</b>
4D0 698 451 C	<b>BA2017</b>	6Q0 698 525	<b>BAE5001</b>	7D0 698 451 G	<b>BA2202</b>
4D0 698 451 F	<b>BA2052</b>	6Q0 698 525 A	<b>BAE5001</b>	7D0 698 451 J	<b>BA2202</b>
4D0 698 451 G	<b>BA2052</b>	6Q0 698 525 B	<b>BAE5001</b>	7H0 615 601 B	<b>BAR22211</b>
4E0 698 151 F	<b>BA2259</b>	6R0 615 301	<b>BAR22151</b>	7H0 698 151	<b>BA2242</b>
4E0 698 151 M	<b>BA2259</b>	6R0 615 301 A	<b>BAR25113</b>	7H0 698 151 A	<b>BA2242</b>
4F0 698 151	<b>BA2172</b>	6R0 698 151 A	<b>BA2154</b>	7H0 698 151 B	<b>BA2242</b>
4F0 698 151 A	<b>BA2259</b>	6U0 615 301	<b>BAR13182</b>	7H0 698 151 C	<b>BA2242</b>
4F0 698 151 D	<b>BA2259</b>	6U0 698 151	<b>BA2039</b>	7H0 698 451	<b>BA2243</b>
4F0 698 451 A	<b>BA2196</b>	6U0 698 151 A	<b>BA2039</b>	7H0 698 451 B	<b>BA2243</b>
4F0 698 451 B	<b>BA2196</b>	6U0 698 525	<b>BAE5001</b>	7H8 698 451	<b>BA2327</b>
4F0 698 451 D	<b>BA2196</b>	6U0 698 525 A	<b>BAE5001</b>	7L0 907 637	<b>BAV1052</b>
4F0 698 451 E	<b>BA2196</b>	6X0 611 775	<b>BAH0033</b>	7L0 907 637 B	<b>BAV1053</b>
531 609 525	<b>BAE5003</b>	701 611 047	<b>BAW2002</b>	7L0 907 637 C	<b>BAV1053</b>
531 609 526	<b>BAE5003</b>	701 611 701 A	<b>BAH0022</b>	7M0 611 701 D	<b>BAH0007</b>
531 609 527	<b>BAE5003</b>	701 615 301 A	<b>BAR24118</b>	7M0 615 301 E	<b>BAR25114</b>
531 609 528	<b>BAE5003</b>	701 615 301 B	<b>BAR18105</b>	7M0 615 301 G	<b>BAR25114</b>
533 698 151 A	<b>BA2037</b>	701 615 301 D	<b>BAR24118</b>	7M0 615 601 A	<b>BAR10223</b>
535 611 701	<b>BAH0014</b>	701 615 301 E	<b>BAR18105</b>	7M0 615 601 B	<b>BAR10223</b>
5C0 615 301	<b>BAR22210</b>	701 615 301 F	<b>BAR24128</b>	7M0 615 601 C	<b>BAR10223</b>
5C0 615 301 A	<b>BAR25145</b>	701 615 301 G	<b>BAR18111</b>	7M0 698 151	<b>BA2147</b>
5C0 615 301 B	<b>BAR25158</b>	701 615 601 A	<b>BAR12138</b>	7M0 698 151 A	<b>BA2147</b>
5C0 698 151	<b>BA2154</b>	701 698 151 B	<b>BA2322</b>	7M0 698 151 B	<b>BA2147</b>
5K0 698 151	<b>BA2195</b>	701 698 151 D	<b>BA2049</b>	7M0 698 451	<b>BA2017</b>
5K0 698 151 A	<b>BA2195</b>	701 698 151 E	<b>BA2049</b>	7M3 611 701	<b>BAH0027</b>
6842 067 20 06 000	<b>BAH0004</b>	701 698 151 F	<b>BA2322</b>	7M3 611 701 A	<b>BAH0027</b>
6K0 611 701	<b>BAH0005</b>	701 698 151 G	<b>BA2322</b>	7M3 611 701 B	<b>BAH0027</b>
6N0 611 053	<b>BAW1701</b>	701 698 151 H	<b>BA2322</b>	7M3 611 701 C	<b>BAH0027</b>
6N0 611 701	<b>BAH0019</b>	701 698 151 J	<b>BA2049</b>	7M3 615 301 A	<b>BAR26115</b>
6N0 611 701 A	<b>BAH0019</b>	701 698 451	<b>BA2202</b>	7M3 698 151	<b>BA2269</b>
6N0 611 701 B	<b>BAH0019</b>	701 698 525	<b>BAE5024</b>	7M3 698 151 A	<b>BA2318</b>
6N0 615 301	<b>BAR10232</b>	701 698 525 A	<b>BAE5024</b>	7M3 698 151 B	<b>BA2231</b>
6N0 615 301 C	<b>BAR18106</b>	701 698 525 B	<b>BAE5024</b>	7M3 698 451	<b>BA2228</b>
6N0 615 301 D	<b>BAR20128</b>	721 611 047	<b>BAW2002</b>	7M3 698 451 A	<b>BA2017</b>
6N0 615 301 F	<b>BAR18106</b>	7D0 611 701 C	<b>BAH0022</b>	7M3 698 451 B	<b>BA2228</b>
6N0 615 601	<b>BAR10111</b>	7D0 611 701 E	<b>BAH0022</b>	7M3 698 451 C	<b>BA2228</b>
6N0 615 601 A	<b>BAR09124</b>	7D0 615 301	<b>BAR26115</b>	7M3 698 451 D	<b>BA2200</b>
6N0 615 601 B	<b>BAR09124</b>	7D0 615 301 A	<b>BAR24128</b>	7M3 698 451 E	<b>BA2228</b>

# Vergleichsliste

Liste des correspondances / Tabella di conversione codici / Lista de comparação /



Lista porównawcza numerów / Porovnávací seznam čísel

AUDI		AUDI		BENDIX	
7M3 698 451 F	<b>BA2200</b>	8E0 615 301 C	<b>BAR25115</b>	171487B	<b>BAH0011</b>
811 615 301	<b>BAR10151</b>	8E0 615 301 D	<b>BAR22152</b>	171492B	<b>BAH0005</b>
811 698 071	<b>BAE5001</b>	8E0 615 301 P	<b>BAR22152</b>	171493B	<b>BAH0016</b>
823 611 707	<b>BAH0010</b>	8E0 615 301 Q	<b>BAR25105</b>	171542B	<b>BAH0008</b>
823 615 301	<b>BAR10151</b>	8E0 615 301 R	<b>BAR25137</b>	171547B	<b>BAH0010</b>
839 615 301	<b>BAR12106</b>	8E0 615 601	<b>BAR10201</b>	172039B	<b>BAH0019</b>
841 615 301	<b>BAR20123</b>	8E0 615 601 A	<b>BAR10224</b>	172042B	<b>BAH0013</b>
849 611 701 G	<b>BAH0010</b>	8E0 615 601 B	<b>BAR10261</b>	172043B	<b>BAH0026</b>
849 611 707 A	<b>BAH0010</b>	8E0 615 601 P	<b>BAR10261</b>	172071B	<b>BAH0024</b>
853 698 151 A	<b>BA2178</b>	8E0 698 151	<b>BA2160</b>	172413B	<b>BAH0033</b>
857 698 451	<b>BA2052</b>	8E0 698 151 A	<b>BA2160</b>	172429B	<b>BAH0019</b>
861 611 053	<b>BAW1905</b>	8E0 698 151 B	<b>BA2198</b>	172430B	<b>BAH0023</b>
861 611 053 A	<b>BAW1501</b>	8E0 698 151 C	<b>BA2259</b>	172435B	<b>BAH0031</b>
861 611 707 A	<b>BAH0008</b>	8E0 698 151 F	<b>BA2172</b>	172458B	<b>BAH0029</b>
861 611 707 B	<b>BAH0008</b>	8E0 698 151 G	<b>BA2259</b>	172477B	<b>BAH0025</b>
861 611 707 C	<b>BAH0008</b>	8E0 698 151 K	<b>BA2172</b>	172479B	<b>BAH0006</b>
867 609 525	<b>BAE5003</b>	8E0 698 151 M	<b>BA2198</b>	172480B	<b>BAH0018</b>
867 609 526	<b>BAE5003</b>	8E0 698 151 N	<b>BA2160</b>	172482B	<b>BAH0017</b>
867 609 527	<b>BAE5003</b>	8E0 698 451	<b>BA2017</b>	172484B	<b>BAH0007</b>
867 609 528	<b>BAE5003</b>	8E0 698 451 A	<b>BA2017</b>	172486B	<b>BAH0022</b>
867 698 151	<b>BA2141</b>	8E0 698 451 D	<b>BA2032</b>	172492B	<b>BAH0006</b>
867 698 520 X	<b>BAE5003</b>	8E0 698 451 E	<b>BA2032</b>	172530B	<b>BAH0021</b>
867 698 525 V	<b>BAE5003</b>	8E0 698 451 F	<b>BA2196</b>	172557B	<b>BAH0020</b>
867 698 525 X	<b>BAE5003</b>	8E0 698 451 J	<b>BA2196</b>	211186B	<b>BAW2501</b>
893 611 707	<b>BAH0012</b>	8E0 698 451 K	<b>BA2017</b>	211746B	<b>BAW1702</b>
893 611 775 A	<b>BAH0003</b>	8E0 698 451 L	<b>BA2032</b>	211748B	<b>BAW1901</b>
895 615 301	<b>BAR13166</b>	8E0 698 451 M	<b>BA2196</b>	211749B	<b>BAW2007</b>
895 615 301 A	<b>BAR22108</b>	8L0 615 301	<b>BAR25123</b>	211961B	<b>BAW2009</b>
895 615 601 A	<b>BAR10261</b>	8L0 615 601	<b>BAR22163</b>	211962B	<b>BAW2008</b>
8A0 615 301 A	<b>BAR22139</b>	8N0 615 301 A	<b>BAR25123</b>	211981B	<b>BAW1903</b>
8A0 615 301 E	<b>BAR22139</b>	8N0 615 601 B	<b>BAR22163</b>	212000B	<b>BAW2002</b>
8A0 698 151	<b>BA2031</b>	8N0 698 151	<b>BA2333</b>	212001B	<b>BAW2002</b>
8A0 698 151 A	<b>BA2031</b>	8N0 698 151 A	<b>BA2205</b>	212007B	<b>BAW2201</b>
8A0 698 151 B	<b>BA2031</b>	8Z0 615 301 B	<b>BAR22151</b>	212008B	<b>BAW1501</b>
8A0 698 151 C	<b>BA2031</b>	8Z0 615 301 D	<b>BAR22151</b>	212040B	<b>BAW1902</b>
8A0 698 151 E	<b>BA2031</b>	8Z0 698 151 A	<b>BA2155</b>	212063B	<b>BAW1401</b>
8D0 611 707	<b>BAH0013</b>	JZW 698 151	<b>BA2155</b>	212064B	<b>BAW1701</b>
8D0 611 707 B	<b>BAH0013</b>	JZW 698 151 A	<b>BA2154</b>	212157B	<b>BAW1905</b>
8D0 611 707 D	<b>BAH0013</b>			212170B	<b>BAW1705</b>
8D0 615 301 J	<b>BAR25137</b>	<b>BENDIX</b>		212171B	<b>BAW1904</b>
8D0 615 301 K	<b>BAR30113</b>			212186B	<b>BAW2501</b>
8D0 615 301 M	<b>BAR30113</b>	171015B	<b>BAH0024</b>	212201B	<b>BAW2004</b>
8D0 615 601 A	<b>BAR10224</b>	171102B	<b>BAH0024</b>	212207B	<b>BAW2201</b>
8D0 615 601 B	<b>BAR10210</b>	171144B	<b>BAH0015</b>	212208B	<b>BAW2007</b>
8D0 698 151	<b>BA2031</b>	171145B	<b>BAH0003</b>	212216B	<b>BAW1703</b>
8D0 698 151 A	<b>BA2148</b>	171155B	<b>BAH0009</b>	212222B	<b>BAW2203</b>
8D0 698 151 C	<b>BA2148</b>	171156B	<b>BAH0004</b>	212228B	<b>BAW2301</b>
8D0 698 151 F	<b>BA2148</b>	171214B	<b>BAH0004</b>	212247B	<b>BAW1906</b>
8D0 698 151 L	<b>BA2031</b>	171260B	<b>BAH0030</b>	212297B	<b>BAW1902</b>
8E0 611 707	<b>BAH0021</b>	171261B	<b>BAH0032</b>	212298B	<b>BAW2003</b>
8E0 611 707 A	<b>BAH0021</b>	171268B	<b>BAH0032</b>	212310B	<b>BAW1701</b>
8E0 611 707 D	<b>BAH0021</b>	171341B	<b>BAH0004</b>	212319B	<b>BAW2600</b>
8E0 611 707 G	<b>BAH0021</b>	171350B	<b>BAH0004</b>	212320B	<b>BAW2800</b>
8E0 615 301 A	<b>BAR25115</b>	171382B	<b>BAH0014</b>	212322B	<b>BAW2001</b>
8E0 615 301 AD	<b>BAR30113</b>	171385B	<b>BAH0012</b>	212323B	<b>BAW1401</b>
8E0 615 301 B	<b>BAR22152</b>	171454B	<b>BAH0001</b>	212324B	<b>BAW1501</b>

# Vergleichsliste

Liste des correspondances / Tabella di conversione codici / Lista de comparação /

Lista porównawcza numerów / Porovnávací seznam čísel



BENDIX		BENDIX		BENDIX	
212326B	BAW1905	361578B	BAE5001	561257B	BAR08104
212328B	BAW2207	362019B	BAE5024	561266B	BAR13167
212333B	BAW2205	362218B	BAE5011	561308B	BAR20114
212334B	BAW1911	362220B	BAE5006	561312B	BAR10178
212335B	BAW1911	362225B	BAE5013	561321B	BAR16105
212337B	BAW2008	362247B	BAE5014	561324B	BAR22122
212338B	BAW2202	362249B	BAE5020	561330B	BAR11137
212341B	BAW2010	362285B	BAE5037	561332B	BAR12117
212343B	BAW2500	362287B	BAE5030	561333B	BAR09118
212344B	BAW1907	362287B	BAE5031	561334B	BAR20126
212378B	BAW2004	362288B	BAE5030	561336B	BAR20125
212384B	BAW1908	362300B	BAE5021	561344B	BAR10185
212390B	BAW1704	362301B	BAE5034	561359B	BAR08107
212392B	BAW1706	362312B	BAE5016	561364B	BAR20133
212395B	BAW2204	362318B	BAE5002	561373B	BAR24112
212396B	BAW2206	362320B	BAE5022	561375B	BAR10115
212401B	BAW1914	362337B	BAE5023	561380B	BAR11119
212411B	BAW2600	362338B	BAE5042	561387B	BAR22147
212413B	BAW1914	362340B	BAE5026	561388B	BAR12125
212415B	BAW1707	362341B	BAE5020	561406B	BAR24111
221504B	BAW2010	362363B	BAE5017	561408B	BAR10191
221506B	BAW2500	362368B	BAE5026	561409B	BAR20132
221749B	BAW2007	362377B	BAE5035	561448B	BAR20128
221961B	BAW2009	362382B	BAE5019	561453B	BAR28102
221962B	BAW2008	362384B	BAE5015	561454B	BAR09114
221981B	BAW1903	362385B	BAE5009	561460B	BAR10111
222000B	BAW2002	362386B	BAE5004	561468B	BAR20142
222001B	BAW2002	362389B	BAE5012	561469B	BAR12127
222007B	BAW2201	362391B	BAE5041	561476B	BAR12124
222008B	BAW1501	362392B	BAE5029	561478B	BAR22103
222040B	BAW1902	362396B	BAE5038	561479B	BAR28101
222063B	BAW1401	362397B	BAE5007	561486B	BAR18107
222064B	BAW1701	362406B	BAE5010	561488B	BAR24115
222310B	BAW1701	362410B	BAE5032	561491B	BAR13178
222324B	BAW1501	362412B	BAE5039	561496B	BAR10196
251004B	BAW1909	362413B	BAE5036	561512B	BAR26105
251005B	BAW1910	362414B	BAE5018	561513B	BAR20147
251018B	BAW2006	362415B	BAE5028	561521B	BAR19109
251019B	BAW2005	362419B	BAE5040	561523B	BAR26109
251022B	BAW1913	362426B	BAE5033	561547B	BAR15105
251023B	BAW1912	376560B	BAE5034	561548B	BAR25105
251026B	BAW1909	561074B	BAR11115	561549B	BAR10201
251027B	BAW1910	561087B	BAR10151	561550B	BAR12126
251034B	BAW2005	561102B	BAR13137	561551B	BAR22115
251035B	BAW2006	561116B	BAR10189	561552B	BAR10202
251036B	BAW2005	561135B	BAR16100	561553B	BAR30101
251037B	BAW2006	561141B	BAR12106	561554B	BAR12132
361213B	BAE5006	561142B	BAR10152	561555B	BAR08106
361216B	BAE5003	561158B	BAR13161	561589B	BAR10205
361342B	BAE5035	561171B	BAR24103	561590B	BAR21106
361426B	BAE5014	561178B	BAR20123	561592B	BAR22148
361450B	BAE5008	561235B	BAR12116	561593B	BAR24171
361536B	BAE5021	561238B	BAR13160	561595B	BAR10219
361554B	BAE5020	561244B	BAR22118	561610B	BAR24118
361570B	BAE5027	561248B	BAR20115	561615B	BAR10215
361576B	BAE5005	561253B	BAR10187	561619B	BAR22100



# Vergleichsliste

Liste des correspondances / Tabella di conversione codici / Lista de comparação /



Lista porównawcza numerów / Porovnávací seznam čísel

BENDIX		BENDIX		BENDIX	
561620B	BAR10203	562040B	BAR22151	562188B	BAR25138
561624B	BAR24131	562041B	BAR25113	562190B	BAR28129
561625B	BAR24132	562042B	BAR10230	562192B	BAR10261
561630B	BAR21105	562043B	BAR25114	562193B	BAR12154
561652B	BAR10204	562044B	BAR13184	562195B	BAR11152
561663B	BAR12137	562045B	BAR20133	562196B	BAR24166
561672B	BAR18124	562048B	BAR12144	562198B	BAR26115
561673B	BAR22166	562049B	BAR22168	562199B	BAR25137
561678B	BAR24120	562051B	BAR12149	562200B	BAR30107
561689B	BAR22139	562052B	BAR25115	562204B	BAR11151
561690B	BAR13166	562053B	BAR09123	562205B	BAR30113
561691B	BAR22108	562054B	BAR22162	562212B	BAR28141
561696B	BAR12128	562055B	BAR13185	562213B	BAR10278
561697B	BAR22132	562057B	BAR10223	562216B	BAR25141
561698B	BAR09120	562059B	BAR10229	562224B	BAR28136
561704B	BAR09122	562060B	BAR22152	562229B	BAR12157
561716B	BAR24129	562062B	BAR10227	562235B	BAR25145
561730B	BAR28104	562065B	BAR10228	562237B	BAR22210
561822B	BAR25124	562066B	BAR28106	562238B	BAR12158
561824B	BAR24146	562069B	BAR24152	562240B	BAR25142
561857B	BAR18105	562070B	BAR25131	562241B	BAR28132
561861B	BAR20142	562071B	BAR10251	562243B	BAR28142
561863B	BAR10261	562072B	BAR10250	562244B	BAR26122
561866B	BAR26102	562073B	BAR13182	562258B	BAR12169
561870B	BAR12131	562078B	BAR22172	562261B	BAR09139
561871B	BAR18113	562079B	BAR18111	562262B	BAR22211
561960B	BAR25119	562080B	BAR24128	562263B	BAR10280
561961B	BAR10225	562081B	BAR12138	562264B	BAR10285
561962B	BAR10226	562086B	BAR22161	562277B	BAR25158
561963B	BAR09114	562088B	BAR24159	562278B	BAR25148
561965B	BAR22161	562089B	BAR10258	562287B	BAR25124
561967B	BAR26104	562090B	BAR22160	562290B	BAR20174
561968B	BAR22158	562093B	BAR10273	562293B	BAR12171
561969B	BAR24138	562094B	BAR19108	562309B	BAR18137
561980B	BAR10232	562099B	BAR26116	567760B	BAR22161
561981B	BAR18106	562101B	BAR32115	567761B	BAR16110
561982B	BAR10210	562103B	BAR24158	567771B	BAR12142
561984B	BAR24127	562104B	BAR24171	567810B	BAR22196
561992B	BAR18108	562105B	BAR24162	569120B	BAR12142
561997B	BAR21106	562115B	BAR26108	569121B	BAR16110
562003B	BAR19107	562120B	BAR22161	569122B	BAR22161
562005B	BAR10224	562128B	BAR22194	571202B	BA2041
562006B	BAR12127	562129B	BAR26120	571243B	BA2082
562007B	BAR10211	562130B	BAR09137	571255B	BA2109
562013B	BAR25110	562132B	BAR25123	571255B-AS	BA2109
562014B	BAR10217	562133B	BAR22163	571255X	BA2109
562019B	BAR26106	562134B	BAR30109	571261B	BA2193
562022B	BAR22166	562149B	BAR08111	571261B-AS	BA2193
562027B	BAR24139	562155B	BAR09136	571271B	BA2185
562032B	BAR10215	562156B	BAR12142	571271B-AS	BA2185
562033B	BAR20155	562165B	BAR22206	571271X	BA2185
562034B	BAR28106	562171B	BAR09124	571272B	BA2101
562035B	BAR22159	562173B	BAR28123	571272B-AS	BA2101
562036B	BAR20154	562177B	BAR09133	571272X	BA2101
562038B	BAR12141	562178B	BAR22197	571276B	BA2134
562039B	BAR22150	562180B	BAR24161	571276B-AS	BA2134

# Vergleichsliste

Liste des correspondances / Tabella di conversione codici / Lista de comparação /



Lista porównawcza numerów / Porovnávací seznam čísel

BENDIX		BENDIX		BENDIX	
571276X	BA2134	571355B	BA2125	571456B	BA2181
571279B	BA2162	571355B-AS	BA2125	571457B	BA2244
571297B	BA2064	571355X	BA2125	571458B	BA2322
571297B	BA2065	571356B	BA2028	571462B	BA2052
571297X	BA2064	571356B-AS	BA2028	571463B	BA2062
571297X	BA2065	571356X	BA2028	571463X	BA2062
571300B	BA2189	571357B	BA2038	571464B	BA2064
571300B-AS	BA2189	571357B-AS	BA2038	571473B	BA2097
571302B	BA2056	571357X	BA2038	571473B-AS	BA2097
571302B-AS	BA2056	571359B	BA2043	571473X	BA2097
571302X	BA2056	571359B-AS	BA2043	571476B	BA2050
571304B	BA2024	571359X	BA2043	571477B	BA2174
571306B	BA2086	571361B	BA2032	571477B-AS	BA2174
571306B-AS	BA2086	571361B-AS	BA2032	571492B	BA2136
571309B	BA2034	571361X	BA2032	571492B-AS	BA2136
571313B	BA2050	571363B	BA2106	571492X	BA2136
571315B	BA2131	571367B	BA2096	571493B	BA2175
571315B-AS	BA2131	571367B-AS	BA2096	571509B	BA2140
571315X	BA2131	571367X	BA2096	571509B-AS	BA2140
571316B	BA2133	571376B	BA2037	571509X	BA2140
571316B-AS	BA2133	571376B-AS	BA2037	571511B	BA2013
571316X	BA2133	571376X	BA2037	571512B	BA2135
571317B	BA2132	571380B	BA2025	571521B	BA2068
571317B-AS	BA2132	571380B-AS	BA2025	571521B-AS	BA2068
571317X	BA2132	571380X	BA2025	571522B	BA2138
571319B	BA2020	571382B	BA2029	571522X	BA2138
571319X	BA2020	571382B-AS	BA2029	571523B	BA2073
571320B	BA2036	571382X	BA2029	571524B	BA2066
571320X	BA2036	571387B	BA2054	571524X	BA2066
571321B	BA2019	571387B-AS	BA2054	571525B	BA2074
571327B-AS	BA2023	571388B	BA2161	571525B-AS	BA2074
571330B	BA2033	571389B	BA2095	571525X	BA2074
571330X	BA2033	571391B	BA2137	571526B	BA2023
571331B	BA2075	571391B-AS	BA2137	571526X	BA2023
571331B	BA2077	571391X	BA2137	571527B	BA2053
571331X	BA2075	571398B	BA2099	571528B	BA2072
571331X	BA2077	571405B	BA2048	571536B	BA2144
571332B	BA2055	571405X	BA2048	571536X	BA2144
571332X	BA2055	571406B	BA2020	571539B	BA2134
571333B	BA2055	571406X	BA2020	571539B-AS	BA2134
571333X	BA2055	571407B	BA2098	571540B	BA2039
571334B	BA2076	571407X	BA2098	571542B	BA2188
571334X	BA2076	571409B	BA2035	571542B-AS	BA2188
571335B	BA2076	571411B	BA2108	571545B	BA2054
571335B-AS	BA2076	571412B	BA2146	571546B	BA2054
571339B	BA2060	571413B	BA2182	571546B-AS	BA2054
571339X	BA2060	571413B-AS	BA2182	571554B	BA2162
571344B	BA2093	571414B	BA2014	571554B-AS	BA2162
571346B	BA2040	571421B	BA2227	571555B	BA2094
571350B	BA2052	571425B	BA2107	571555B-AS	BA2094
571352B	BA2026	571425B-AS	BA2107	571559B	BA2027
571352B-AS	BA2026	571435B	BA2161	571560B	BA2029
571352X	BA2026	571436B	BA2011	571560B-AS	BA2029
571353B	BA2027	571437B	BA2012	571722B	BA2163
571353B-AS	BA2027	571438B	BA2010	571722B-AS	BA2163
571353X	BA2027	571439B	BA2187	571725B	BA2084

# Vergleichsliste

Liste des correspondances / Tabella di conversione codici / Lista de comparação /



Lista porównawcza numerów / Porovnávací seznam čísel

BENDIX		BENDIX		BENDIX	
571725B-AS	BA2084	571898X	BA2016	571954B	BA2089
571726B	BA2084	571900B	BA2147	571954B-AS	BA2089
571726B-AS	BA2084	571902B	BA2151	571955B	BA2160
571743B	BA2074	571902B-AS	BA2151	571959B	BA2108
571743X	BA2074	571904B	BA2048	571959B-AS	BA2108
571745B	BA2081	571906B	BA2017	571959X	BA2108
571745X	BA2081	571906X	BA2017	571960B	BA2053
571746B	BA2080	571910B	BA2215	571960B-AS	BA2053
571746X	BA2080	571910B-AS	BA2215	571961B	BA2184
571749B	BA2071	571911B	BA2083	571961B-AS	BA2184
571754B	BA2276	571911X	BA2083	571964B	BA2084
571755B	BA2286	571912B	BA2100	571967B	BA2209
571757B	BA2078	571912B-AS	BA2100	571968B	BA2173
571816B	BA2126	571913B	BA2146	571969B	BA2018
571828B	BA2044	571914B	BA2144	571971B	BA2155
571828B-AS	BA2044	571915B	BA2145	571974B	BA2334
571832B	BA2139	571915X	BA2145	571975B	BA2211
571833B	BA2134	571918B	BA2167	571976B	BA2010
571833B-AS	BA2134	571918B-AS	BA2167	571976X	BA2010
571838B	BA2047	571919B	BA2021	571981B	BA2260
571838B-AS	BA2047	571919B-AS	BA2021	571981B-AS	BA2260
571839B	BA2045	571920B	BA2207	571982B	BA2172
571839X	BA2045	571921B	BA2148	571982X	BA2172
571840B	BA2046	571922B	BA2022	571984B	BA2205
571840X	BA2046	571922B-AS	BA2022	571985B	BA2154
571843B	BA2079	571923B	BA2152	571986B	BA2177
571844B	BA2149	571923D	BA2152	571986B-AS	BA2177
571845B	BA2250	571923X	BA2152	571987B	BA2177
571845B-AS	BA2250	571924B	BA2136	571987B-AS	BA2177
571846B	BA2233	571925B	BA2164	571988B	BA2206
571846B-AS	BA2233	571925B-AS	BA2164	571988B-AS	BA2206
571847B	BA2049	571929B	BA2154	571989B	BA2218
571847B-AS	BA2049	571930B	BA2090	571990B	BA2245
571848B	BA2141	571930B-AS	BA2090	571990B-AS	BA2245
571848X	BA2141	571931B	BA2090	571992B	BA2267
571855B	BA2030	571931B-AS	BA2090	571992B-AS	BA2267
571864B	BA2037	571932B	BA2320	571994B	BA2190
571868B	BA2027	571932B-AS	BA2320	571994B-AS	BA2190
571873B	BA2166	571934B	BA2171	571995B	BA2217
571873B-AS	BA2166	571934B	BA2201	571996B	BA2203
571875B	BA2202	571935B	BA2333	571998B	BA2208
571875B	BA2247	571936B	BA2170	572122B	BA2227
571875B-AS	BA2202	571939B	BA2153	572138B	BA2280
571876B	BA2168	571939X	BA2153	572145B	BA2115
571876B-AS	BA2168	571940B	BA2268	572210B	BA2113
571877B	BA2150	571941B	BA2226	572227B	BA2114
571877B-AS	BA2150	571944B	BA2176	572255B	BA2121
571880B	BA2169	571944B-AS	BA2176	572257B	BA2232
571880B-AS	BA2169	571945B	BA2176	572268B	BA2111
571882B	BA2142	571945B-AS	BA2176	572269B	BA2292
571883B	BA2143	571946B	BA2091	572271B	BA2114
571887B	BA2142	571947B	BA2290	572272B	BA2114
571893B	BA2073	571947B-AS	BA2290	572280B	BA2112
571897B	BA2015	571948B	BA2322	572281B	BA2112
571897X	BA2015	571949B	BA2332	572317B	BA2110
571898B	BA2016	571950B	BA2216	572324B	BA2274

# Vergleichsliste

Liste des correspondances / Tabella di conversione codici / Lista de comparação /



Lista porównawcza numerów / Porovnávací seznam čísel

BENDIX		BENDIX		BENDIX	
572325B	BA2118	573051B	BA2089	573274B	BA2265
572333B	BA2116	573052B	BA2244	573275B	BA2306
572336B	BA2110	573053B	BA2213	573276B	BA2305
572370B	BA2249	573055B	BA2261	573277B	BA2304
572381B	BA2117	573056B	BA2272	581300B	BAV1007
572382B	BA2119	573058B	BA2254	581301B	BAV1002
572396B	BA2113	573058B-AS	BA2254	581302B	BAV1035
572402B	BA2123	573059B	BA2247	581303B	BAV1003
572403B	BA2122	573060B	BA2325	581304B	BAV1004
572405B	BA2294	573065B	BA2228	581305B	BAV1001
572407B	BA2122	573075B	BA2299	581329B	BAV1003
572408B	BA2122	573082B	BA2220	581330B	BAV1005
572422B	BA2273	573083B	BA2282	581331B	BAV1006
572428B	BA2278	573089B	BA2236	581332B	BAV1004
572429B	BA2278	573091B	BA2221	581333B	BAV1004
572430B	BA2010	573092B	BA2204	581337B	BAV1028
572434B	BA2118	573092B-AS	BA2204	581338B	BAV1029
572447B	BA2249	573093B	BA2164	581341B	BAV1027
572450B	BA2293	573093B-AS	BA2164	581345B	BAV1031
572468B	BA2121	573095B	BA2022	581349B	BAV1051
572485B	BA2295	573095B-AS	BA2022	581350B	BAV1033
572491B	BA2270	573096B	BA2285	581353B	BAV1032
572492B	BA2331	573105B	BA2303	581357B	BAV1019
572516B	BA2326	573106B	BA2201	581361B	BAV1024
573002B	BA2169	573107B	BA2251	581362B	BAV1050
573002B-AS	BA2169	573110B	BA2262	581365B	BAV1018
573003B	BA2253	573113B	BA2241	581367B	BAV1021
573003B-AS	BA2253	573114B	BA2324	581368B	BAV1047
573005B	BA2212	573115B	BA2323	581369B	BAV1036
573006B	BA2198	573120B	BA2225	581370B	BAV1049
573008B	BA2219	573122B	BA2194	581371B	BAV1030
573010B	BA2197	573124B	BA2230	581372B	BAV1015
573011B	BA2210	573125B	BA2284	581373B	BAV1017
573012B	BA2225	573127B	BA2298	581374B	BAV1011
573013B	BA2224	573128B	BA2195	581375B	BAV1014
573014B	BA2271	573130B	BA2334	581376B	BAV1016
573017B	BA2288	573135B	BA2296	581377B	BAV1010
573018B	BA2238	573136B	BA2308	581378B	BAV1013
573020B	BA2224	573137B	BA2307	581379B	BAV1046
573021B	BA2279	573138B	BA2311	581380B	BAV1009
573022B	BA2269	573139B	BA2309	581381B	BAV1012
573030B	BA2214	573145B	BA2246	581383B	BAV1023
573031B	BA2229	573151B	BA2252	581384B	BAV1026
573032B	BA2017	573152B	BA2204	581386B	BAV1020
573034B	BA2191	573153B	BA2255	581388B	BAV1005
573035B	BA2192	573158B	BA2196	581389B	BAV1006
573037B	BA2172	573159B	BA2242	587010B	BAV1008
573038B	BA2200	573160B	BA2242		
573039B	BA2237	573161B	BA2190	<b>BMW</b>	
573041B	BA2199	573164B	BA2283		
573042B	BA2315	573169B	BA2072	34 10 1 166 071	BAR25138
573047B	BA2318	573171B	BA2289	34 11 1 117 002	BA2185
573047B-AS	BA2318	573183B	BA2214	34 11 1 117 352	BA2185
573048B	BA2247	573184B	BA2229	34 11 1 118 517	BA2185
573049B	BA2200	573196B	BA2259	34 11 1 119 176	BA2193
573050B	BA2321	573260B	BA2275	34 11 1 119 177	BA2193

# Vergleichsliste

Liste des correspondances / Tabella di conversione codici / Lista de comparação /



Lista porównawcza numerów / Porovnávací seznam čísel

BMW		BMW		BMW	
34 11 1 150 524	<b>BA2185</b>	34 11 1 163 387	<b>BA2169</b>	34 11 6 763 089	<b>BA2245</b>
34 11 1 150 527	<b>BA2185</b>	34 11 1 163 850	<b>BA2108</b>	34 11 6 763 591	<b>BA2245</b>
34 11 1 152 607	<b>BAV1007</b>	34 11 1 163 953	<b>BA2169</b>	34 11 6 763 617	<b>BA2252</b>
34 11 1 153 203	<b>BA2188</b>	34 11 1 164 199	<b>BAR22115</b>	34 11 6 763 618	<b>BA2252</b>
34 11 1 154 443	<b>BA2026</b>	34 11 1 164 330	<b>BA2169</b>	34 11 6 764 021	<b>BAR24181</b>
34 11 1 154 611	<b>BA2188</b>	34 11 1 164 331	<b>BA2169</b>	34 11 6 764 540	<b>BA2245</b>
34 11 1 154 747	<b>BAR13167</b>	34 11 1 164 431	<b>BAR22115</b>	34 11 6 765 457	<b>BAR30109</b>
34 11 1 154 749	<b>BAR22122</b>	34 11 1 164 498	<b>BA2108</b>	34 11 6 766 036	<b>BAR30109</b>
34 11 1 154 750	<b>BAR22122</b>	34 11 1 164 500	<b>BA2108</b>	34 11 6 766 224	<b>BAR22160</b>
34 11 1 155 076	<b>BA2188</b>	34 11 1 164 539	<b>BAR22160</b>	34 11 6 766 239	<b>BAR22115</b>
34 11 1 155 998	<b>BA2026</b>	34 11 1 164 627	<b>BA2169</b>	34 11 6 767 059	<b>BAR30107</b>
34 11 1 155 999	<b>BA2026</b>	34 11 1 164 629	<b>BA2169</b>	34 11 6 767 061	<b>BAR22159</b>
34 11 1 156 898	<b>BA2026</b>	34 11 1 164 737	<b>BA2108</b>	34 11 6 767 143	<b>BA2307</b>
34 11 1 156 899	<b>BA2026</b>	34 11 1 164 839	<b>BAR22159</b>	34 11 6 767 144	<b>BA2307</b>
34 11 1 157 510	<b>BA2188</b>	34 11 1 164 921	<b>BAR22115</b>	34 11 6 767 191	<b>BA2245</b>
34 11 1 157 561	<b>BA2188</b>	34 11 1 165 227	<b>BA2166</b>	34 11 6 767 269	<b>BAR30173</b>
34 11 1 157 569	<b>BA2125</b>	34 11 1 165 455	<b>BAR22115</b>	34 11 6 767 580	<b>BA2245</b>
34 11 1 157 747	<b>BA2026</b>	34 11 1 165 555	<b>BA2108</b>	34 11 6 769 305	<b>BAR25138</b>
34 11 1 157 748	<b>BA2026</b>	34 11 1 165 556	<b>BA2108</b>	34 11 6 769 763	<b>BA2311</b>
34 11 1 157 813	<b>BA2125</b>	34 11 1 165 557	<b>BA2108</b>	34 11 6 769 951	<b>BA2311</b>
34 11 1 157 923	<b>BA2188</b>	34 11 1 165 859	<b>BAR30107</b>	34 11 6 771 837	<b>BA2307</b>
34 11 1 158 038	<b>BAR28101</b>	34 11 2 225 107	<b>BAV1003</b>	34 11 6 771 838	<b>BA2307</b>
34 11 1 158 040	<b>BAR22103</b>	34 11 2 226 009	<b>BA2193</b>	34 11 6 771 868	<b>BA2252</b>
34 11 1 158 042	<b>BAR12124</b>	34 11 2 226 084	<b>BA2188</b>	34 11 6 774 050	<b>BA2307</b>
34 11 1 158 265	<b>BA2125</b>	34 11 2 228 248	<b>BA2125</b>	34 11 6 777 772	<b>BA2252</b>
34 11 1 158 316	<b>BA2026</b>	34 11 2 229 031	<b>BA2166</b>	34 11 6 779 652	<b>BA2190</b>
34 11 1 159 249	<b>BA2185</b>	34 11 2 282 090	<b>BA2166</b>	34 11 6 781 873	<b>BA2245</b>
34 11 1 159 261	<b>BA2193</b>	34 11 2 282 166	<b>BA2166</b>	34 11 6 799 166	<b>BA2252</b>
34 11 1 159 279	<b>BA2125</b>	34 11 2 282 554	<b>BA2125</b>	34 11 6 855 152	<b>BAR22160</b>
34 11 1 159 415	<b>BA2188</b>	34 11 2 282 556	<b>BA2166</b>	34 11 6 855 156	<b>BAR25138</b>
34 11 1 159 895	<b>BAR30101</b>	34 11 2 283 865	<b>BA2245</b>	34 11 9 070 047	<b>BA2108</b>
34 11 1 159 896	<b>BAR28101</b>	34 11 3 404 362	<b>BA2190</b>	34 20 1 166 073	<b>BAR22209</b>
34 11 1 159 897	<b>BAR22103</b>	34 11 3 427 503	<b>BA2166</b>	34 21 1 153 196	<b>BA2189</b>
34 11 1 159 898	<b>BAR12124</b>	34 11 6 750 148	<b>BA2190</b>	34 21 1 154 613	<b>BA2189</b>
34 11 1 159 916	<b>BAR30101</b>	34 11 6 750 713	<b>BAR30109</b>	34 21 1 155 077	<b>BA2189</b>
34 11 1 160 356	<b>BA2108</b>	34 11 6 752 434	<b>BAR13167</b>	34 21 1 156 463	<b>BA2189</b>
34 11 1 160 450	<b>BA2125</b>	34 11 6 752 482	<b>BA2108</b>	34 21 1 156 746	<b>BA2189</b>
34 11 1 160 522	<b>BA2026</b>	34 11 6 752 731	<b>BA2108</b>	34 21 1 156 748	<b>BA2189</b>
34 11 1 160 532	<b>BA2108</b>	34 11 6 753 221	<b>BAR30173</b>	34 21 1 157 334	<b>BA2054</b>
34 11 1 160 673	<b>BAR12126</b>	34 11 6 753 668	<b>BA2245</b>	34 21 1 157 514	<b>BA2189</b>
34 11 1 160 674	<b>BAR22115</b>	34 11 6 754 705	<b>BA2190</b>	34 21 1 157 814	<b>BA2054</b>
34 11 1 160 915	<b>BAR22122</b>	34 11 6 756 045	<b>BAR30109</b>	34 21 1 157 925	<b>BA2189</b>
34 11 1 160 936	<b>BAR22103</b>	34 11 6 756 090	<b>BAR28101</b>	34 21 1 157 926	<b>BA2189</b>
34 11 1 161 347	<b>BA2026</b>	34 11 6 756 128	<b>BA2108</b>	34 21 1 157 953	<b>BAR12132</b>
34 11 1 161 349	<b>BA2026</b>	34 11 6 757 526	<b>BAR22160</b>	34 21 1 158 221	<b>BA2054</b>
34 11 1 161 437	<b>BA2108</b>	34 11 6 757 746	<b>BAR30101</b>	34 21 1 158 266	<b>BA2054</b>
34 11 1 161 445	<b>BA2108</b>	34 11 6 757 750	<b>BAR12126</b>	34 21 1 158 268	<b>BA2054</b>
34 11 1 161 693	<b>BAR12124</b>	34 11 6 761 237	<b>BA2108</b>	34 21 1 158 642	<b>BA2054</b>
34 11 1 161 717	<b>BA2188</b>	34 11 6 761 242	<b>BA2108</b>	34 21 1 158 936	<b>BAR10202</b>
34 11 1 162 282	<b>BAR22115</b>	34 11 6 761 243	<b>BA2190</b>	34 21 1 159 146	<b>BAW2202</b>
34 11 1 162 288	<b>BAR22115</b>	34 11 6 761 244	<b>BA2108</b>	34 21 1 159 273	<b>BA2189</b>
34 11 1 162 481	<b>BA2026</b>	34 11 6 761 252	<b>BA2166</b>	34 21 1 159 569	<b>BAW2301</b>
34 11 1 162 535	<b>BA2125</b>	34 11 6 761 278	<b>BA2169</b>	34 21 1 159 900	<b>BAR12132</b>
34 11 1 163 013	<b>BAR22159</b>	34 11 6 761 279	<b>BA2169</b>	34 21 1 160 198	<b>BA2054</b>
34 11 1 163 081	<b>BAR22159</b>	34 11 6 761 280	<b>BA2169</b>	34 21 1 160 340	<b>BA2053</b>
34 11 1 163 307	<b>BA2166</b>	34 11 6 761 283	<b>BA2245</b>	34 21 1 160 504	<b>BAE5013</b>

# Vergleichsliste

Liste des correspondances / Tabella di conversione codici / Lista de comparação /



Lista porównawcza numerów / Porovnávací seznam čísel

BMW		BMW		BOSCH	
34 21 1 160 809	BAR10211	34 21 6 778 168	BA2053	0 204 011 249	BAW1707
34 21 1 160 533	BA2053	34 21 6 779 294	BA2308	0 204 100 544	BA2260
34 21 1 161 455	BA2053	34 21 6 788 183	BA2308	0 204 116 157	BAW2009
34 21 1 162 289	BAR10202	34 21 9 067 127	BAE5013	0 204 116 158	BAW2008
34 21 1 162 315	BAR19107	34 30 1 165 190	BAH0025	0 204 116 169	BAW2002
34 21 1 162 446	BA2053	34 32 1 159 717	BAH0001	0 204 116 171	BAW2010
34 21 1 162 536	BA2053	34 32 1 165 587	BAH0017	0 204 116 173	BAW2500
34 21 1 163 153	BAR20154	34 32 6 766 966	BAH0017	0 204 116 181	BAW1906
34 21 1 163 324	BA2167	34 35 1 153 964	BAV1002	0 204 116 206	BAW1909
34 21 1 163 326	BA2167	34 35 1 163 065	BAV1009	0 204 116 207	BAW1910
34 21 1 163 395	BA2170	34 35 1 163 066	BAV1010	0 204 116 222	BAW1913
34 21 1 163 669	BAR10227	34 35 1 163 207	BAV1015	0 204 116 223	BAW1912
34 21 1 163 835	BAR10227	34 35 1 164 371	BAV1012	0 204 116 228	BAW1909
34 21 1 163 845	BAR10273	34 35 1 164 372	BAV1013	0 204 116 229	BAW1910
34 21 1 164 129	BAR10227	34 35 1 165 579	BAV1018	0 204 116 236	BAW2005
34 21 1 164 175	BAR20154	34 35 1 165 580	BAV1019	0 204 116 237	BAW2006
34 21 1 164 399	BAR10273	34 35 1 179 819	BAV1007	0 204 116 238	BAW2005
34 21 1 164 499	BA2053	34 35 1 179 820	BAV1003	0 204 116 239	BAW2006
34 21 1 164 501	BA2053	34 35 1 179 821	BAV1035	0 204 116 249	BAW2010
34 21 1 164 581	BA2167	34 35 1 180 432	BAV1003	0 204 116 251	BAW2500
34 21 1 164 582	BA2167	34 35 1 180 780	BAV1035	0 204 116 397	BAW1903
34 21 1 164 840	BAR20154	34 35 1 180 781	BAV1003	0 204 116 451	BAW1401
34 21 1 165 211	BAR19107	34 35 1 180 782	BAV1007	0 204 116 454	BAW1902
34 21 1 165 233	BA2053	34 35 1 181 337	BAV1006	0 204 116 479	BAW1701
34 21 1 165 235	BA2053	34 35 1 181 338	BAV1006	0 204 116 480	BAW1907
34 21 1 165 457	BAR10202	34 35 1 181 342	BAV1005	0 204 116 482	BAW2207
34 21 1 165 563	BAR19108	34 35 1 181 344	BAV1005	0 204 116 502	BAW1702
34 21 2 225 229	BAV1035	34 35 1 182 064	BAV1036	0 204 116 564	BAW1908
34 21 2 226 013	BA2189	34 35 1 182 533	BAV1011	0 204 116 565	BAW1902
34 21 3 403 241	BA2167	34 35 2 227 385	BAV1031	0 204 116 567	BAW2002
34 21 6 750 160	BA2167	34 35 2 229 018	BAV1009	0 204 116 568	BAW2002
34 21 6 750 190	BA2053	34 35 6 751 311	BAV1021	0 204 116 578	BAW2500
34 21 6 753 215	BAR20183	34 35 6 755 266	BAV1022	0 204 116 579	BAW2204
34 21 6 757 748	BAR12132	34 35 6 755 267	BAV1037	0 204 116 580	BAW2206
34 21 6 758 552	BAR10211	34 35 6 762 252	BAV1042	0 204 116 581	BAW2007
34 21 6 761 238	BA2053	34 35 6 762 253	BAV1043	0 204 116 604	BAW2009
34 21 6 761 239	BA2053	34 35 6 763 667	BAV1041	0 204 173 008	BAR26138
34 21 6 761 240	BA2167	34 35 6 764 298	BAV1025	0 204 204 174	BA2216
34 21 6 761 241	BA2053	34 35 6 764 299	BAV1040	0 986 424 016	BA2181
34 21 6 761 248	BA2167	34 35 6 768 595	BAV1025	0 986 424 030	BA2045
34 21 6 761 250	BA2167	34 35 6 768 596	BAV1040	0 986 424 031	BA2046
34 21 6 761 253	BA2054	34 35 6 768 597	BAV1041	0 986 424 033	BA2047
34 21 6 761 281	BA2170	34 35 6 776 421	BAV1025	0 986 424 092	BA2011
34 21 6 763 043	BA2240	34 35 6 776 422	BAV1040	0 986 424 098	BA2064
34 21 6 763 044	BA2240	34 35 6 776 423	BAV1041	0 986 424 135	BA2111
34 21 6 767 049	BAR10227	34 35 6 778 037	BAV1022	0 986 424 185	BA2167
34 21 6 767 060	BAR20154	34 35 6 778 038	BAV1037	0 986 424 204	BA2119
34 21 6 767 145	BA2308	34 35 6 789 439	BAV1042	0 986 424 214	BA2010
34 21 6 767 146	BA2308	34 35 6 789 445	BAV1043	0 986 424 218	BA2149
34 21 6 767 150	BA2309	34 35 6 789 492	BAV1025	0 986 424 219	BA2215
34 21 6 770 252	BA2272	34 35 6 789 493	BAV1040	0 986 424 223	BA2016
34 21 6 772 085	BAR20183	34 35 6 789 494	BAV1041	0 986 424 227	BA2015
34 21 6 773 161	BA2309	34 35 9 058 889	BAV1002	0 986 424 229	BA2250
34 21 6 774 417	BA2308	61 31 1 361 896	BAV1035	0 986 424 233	BA2168
34 21 6 774 692	BA2309			0 986 424 234	BA2150
34 21 6 777 240	BA2308			0 986 424 236	BA2147

# Vergleichsliste

Liste des correspondances / Tabella di conversione codici / Lista de comparação /



Lista porównawcza numerów / Porovnávací seznam čísel

<b>BOSCH</b>		<b>BOSCH</b>		<b>BOSCH</b>	
0 986 424 244	<b>BA2012</b>	0 986 424 487	<b>BA2090</b>	0 986 424 657	<b>BA2262</b>
0 986 424 246	<b>BA2142</b>	0 986 424 490	<b>BA2273</b>	0 986 424 659	<b>BA2229</b>
0 986 424 277	<b>BA2276</b>	0 986 424 496	<b>BA2164</b>	0 986 424 659	<b>BA2289</b>
0 986 424 287	<b>BA2187</b>	0 986 424 497	<b>BA2213</b>	0 986 424 660	<b>BA2089</b>
0 986 424 295	<b>BA2257</b>	0 986 424 501	<b>BA2205</b>	0 986 424 662	<b>BA2247</b>
0 986 424 347	<b>BA2145</b>	0 986 424 503	<b>BA2155</b>	0 986 424 663	<b>BA2278</b>
0 986 424 359	<b>BA2138</b>	0 986 424 508	<b>BA2160</b>	0 986 424 667	<b>BA2053</b>
0 986 424 360	<b>BA2207</b>	0 986 424 512	<b>BA2123</b>	0 986 424 671	<b>BA2225</b>
0 986 424 361	<b>BA2152</b>	0 986 424 516	<b>BA2216</b>	0 986 424 672	<b>BA2321</b>
0 986 424 362	<b>BA2143</b>	0 986 424 517	<b>BA2177</b>	0 986 424 674	<b>BA2198</b>
0 986 424 364	<b>BA2154</b>	0 986 424 518	<b>BA2177</b>	0 986 424 675	<b>BA2261</b>
0 986 424 365	<b>BA2167</b>	0 986 424 519	<b>BA2164</b>	0 986 424 676	<b>BA2207</b>
0 986 424 371	<b>BA2268</b>	0 986 424 520	<b>BA2206</b>	0 986 424 677	<b>BA2236</b>
0 986 424 373	<b>BA2039</b>	0 986 424 522	<b>BA2220</b>	0 986 424 680	<b>BA2271</b>
0 986 424 375	<b>BA2202</b>	0 986 424 523	<b>BA2249</b>	0 986 424 683	<b>BA2225</b>
0 986 424 376	<b>BA2020</b>	0 986 424 525	<b>BA2273</b>	0 986 424 692	<b>BA2121</b>
0 986 424 377	<b>BA2249</b>	0 986 424 527	<b>BA2210</b>	0 986 424 694	<b>BA2118</b>
0 986 424 379	<b>BA2073</b>	0 986 424 531	<b>BA2022</b>	0 986 424 699	<b>BA2218</b>
0 986 424 400	<b>BA2169</b>	0 986 424 533	<b>BA2219</b>	0 986 424 703	<b>BA2241</b>
0 986 424 402	<b>BA2171</b>	0 986 424 534	<b>BA2294</b>	0 986 424 704	<b>BA2323</b>
0 986 424 410	<b>BA2151</b>	0 986 424 537	<b>BA2201</b>	0 986 424 705	<b>BA2204</b>
0 986 424 411	<b>BA2100</b>	0 986 424 539	<b>BA2279</b>	0 986 424 706	<b>BA2172</b>
0 986 424 414	<b>BA2021</b>	0 986 424 541	<b>BA2237</b>	0 986 424 707	<b>BA2255</b>
0 986 424 415	<b>BA2079</b>	0 986 424 542	<b>BA2200</b>	0 986 424 728	<b>BA2291</b>
0 986 424 416	<b>BA2146</b>	0 986 424 544	<b>BA2332</b>	0 986 424 735	<b>BA2270</b>
0 986 424 427	<b>BA2226</b>	0 986 424 545	<b>BA2035</b>	0 986 424 744	<b>BA2276</b>
0 986 424 449	<b>BA2153</b>	0 986 424 546	<b>BA2224</b>	0 986 424 745	<b>BA2286</b>
0 986 424 450	<b>BA2209</b>	0 986 424 547	<b>BA2163</b>	0 986 424 747	<b>BA2202</b>
0 986 424 451	<b>BA2022</b>	0 986 424 549	<b>BA2260</b>	0 986 424 748	<b>BA2202</b>
0 986 424 452	<b>BA2151</b>	0 986 424 553	<b>BA2271</b>	0 986 424 751	<b>BA2017</b>
0 986 424 453	<b>BA2089</b>	0 986 424 554	<b>BA2334</b>	0 986 424 754	<b>BA2095</b>
0 986 424 453	<b>BA2090</b>	0 986 424 556	<b>BA2325</b>	0 986 424 764	<b>BA2245</b>
0 986 424 454	<b>BA2239</b>	0 986 424 558	<b>BA2199</b>	0 986 424 766	<b>BA2240</b>
0 986 424 455	<b>BA2090</b>	0 986 424 559	<b>BA2228</b>	0 986 424 767	<b>BA2190</b>
0 986 424 456	<b>BA2173</b>	0 986 424 571	<b>BA2214</b>	0 986 424 769	<b>BA2324</b>
0 986 424 457	<b>BA2211</b>	0 986 424 578	<b>BA2315</b>	0 986 424 777	<b>BA2318</b>
0 986 424 459	<b>BA2170</b>	0 986 424 584	<b>BA2166</b>	0 986 424 779	<b>BA2246</b>
0 986 424 460	<b>BA2333</b>	0 986 424 593	<b>BA2143</b>	0 986 424 780	<b>BA2231</b>
0 986 424 462	<b>BA2144</b>	0 986 424 594	<b>BA2303</b>	0 986 424 781	<b>BA2273</b>
0 986 424 463	<b>BA2233</b>	0 986 424 596	<b>BA2299</b>	0 986 424 785	<b>BA2230</b>
0 986 424 468	<b>BA2018</b>	0 986 424 597	<b>BA2283</b>	0 986 424 787	<b>BA2221</b>
0 986 424 469	<b>BA2176</b>	0 986 424 611	<b>BA2191</b>	0 986 424 789	<b>BA2285</b>
0 986 424 470	<b>BA2176</b>	0 986 424 614	<b>BA2251</b>	0 986 424 790	<b>BA2331</b>
0 986 424 471	<b>BA2217</b>	0 986 424 617	<b>BA2238</b>	0 986 424 791	<b>BA2278</b>
0 986 424 472	<b>BA2208</b>	0 986 424 618	<b>BA2288</b>	0 986 424 795	<b>BA2284</b>
0 986 424 474	<b>BA2122</b>	0 986 424 630	<b>BA2293</b>	0 986 424 796	<b>BA2196</b>
0 986 424 475	<b>BA2184</b>	0 986 424 633	<b>BA2269</b>	0 986 424 797	<b>BA2195</b>
0 986 424 476	<b>BA2091</b>	0 986 424 634	<b>BA2282</b>	0 986 424 798	<b>BA2326</b>
0 986 424 478	<b>BA2197</b>	0 986 424 636	<b>BA2254</b>	0 986 424 803	<b>BA2294</b>
0 986 424 479	<b>BA2211</b>	0 986 424 644	<b>BA2084</b>	0 986 424 806	<b>BA2259</b>
0 986 424 480	<b>BA2320</b>	0 986 424 645	<b>BA2203</b>	0 986 424 817	<b>BA2257</b>
0 986 424 481	<b>BA2148</b>	0 986 424 646	<b>BA2194</b>	0 986 424 819	<b>BA2307</b>
0 986 424 482	<b>BA2172</b>	0 986 424 648	<b>BA2192</b>	0 986 424 820	<b>BA2308</b>
0 986 424 483	<b>BA2108</b>	0 986 424 651	<b>BA2245</b>	0 986 424 821	<b>BA2309</b>
0 986 424 484	<b>BA2053</b>	0 986 424 652	<b>BA2267</b>	0 986 424 822	<b>BA2252</b>
0 986 424 485	<b>BA2169</b>	0 986 424 654	<b>BA2272</b>	0 986 424 824	<b>BA2196</b>

# Vergleichsliste

Liste des correspondances / Tabella di conversione codici / Lista de comparação /

Lista porównawcza numerów / Porovnávací seznam čísel



BOSCH		BOSCH		BOSCH	
0 986 424 831	<b>BA2295</b>	0 986 461 764	<b>BA2140</b>	0 986 475 621	<b>BAW1910</b>
0 986 460 002	<b>BA2290</b>	0 986 461 765	<b>BA2050</b>	0 986 475 622	<b>BAW1909</b>
0 986 460 736	<b>BA2062</b>	0 986 461 769	<b>BA2017</b>	0 986 475 629	<b>BAW1910</b>
0 986 460 932	<b>BA2019</b>	0 986 462 803	<b>BA2109</b>	0 986 475 630	<b>BAW1909</b>
0 986 460 937	<b>BA2135</b>	0 986 463 490	<b>BA2082</b>	0 986 475 631	<b>BAW1912</b>
0 986 460 938	<b>BA2136</b>	0 986 464 372	<b>BA2193</b>	0 986 475 632	<b>BAW1913</b>
0 986 460 939	<b>BA2175</b>	0 986 465 141	<b>BA2134</b>	0 986 475 647	<b>BAW2002</b>
0 986 460 943	<b>BA2037</b>	0 986 465 760	<b>BA2126</b>	0 986 475 653	<b>BAW2301</b>
0 986 460 944	<b>BA2038</b>	0 986 465 881	<b>BA2185</b>	0 986 475 674	<b>BAW1703</b>
0 986 460 946	<b>BA2086</b>	0 986 466 302	<b>BA2162</b>	0 986 475 736	<b>BAW2202</b>
0 986 460 947	<b>BA2068</b>	0 986 466 346	<b>BA2077</b>	0 986 475 739	<b>BAW2201</b>
0 986 460 949	<b>BA2084</b>	0 986 466 350	<b>BA2056</b>	0 986 475 752	<b>BAW2203</b>
0 986 460 952	<b>BA2108</b>	0 986 466 402	<b>BA2144</b>	0 986 475 776	<b>BAW1901</b>
0 986 460 953	<b>BA2060</b>	0 986 466 683	<b>BA2032</b>	0 986 475 797	<b>BAW2001</b>
0 986 460 954	<b>BA2322</b>	0 986 466 683	<b>BA2212</b>	0 986 475 798	<b>BAW2008</b>
0 986 460 955	<b>BA2098</b>	0 986 466 693	<b>BA2028</b>	0 986 475 802	<b>BAW2600</b>
0 986 460 958	<b>BA2106</b>	0 986 466 698	<b>BA2178</b>	0 986 475 803	<b>BAW2800</b>
0 986 460 960	<b>BA2114</b>	0 986 466 700	<b>BA2031</b>	0 986 475 816	<b>BAW2003</b>
0 986 460 962	<b>BA2080</b>	0 986 466 751	<b>BA2189</b>	0 986 475 836	<b>BAW2205</b>
0 986 460 963	<b>BA2081</b>	0 986 466 871	<b>BA2094</b>	0 986 475 837	<b>BAW1704</b>
0 986 460 964	<b>BA2053</b>	0 986 466 874	<b>BA2093</b>	0 986 475 838	<b>BAW2007</b>
0 986 460 965	<b>BA2163</b>	0 986 467 411	<b>BA2024</b>	0 986 475 854	<b>BAW1911</b>
0 986 460 966	<b>BA2182</b>	0 986 467 570	<b>BA2188</b>	0 986 475 855	<b>BAW1911</b>
0 986 460 967	<b>BA2099</b>	0 986 467 720	<b>BA2023</b>	0 986 475 871	<b>BAW2008</b>
0 986 460 968	<b>BA2071</b>	0 986 467 760	<b>BA2064</b>	0 986 475 875	<b>BAW1706</b>
0 986 460 969	<b>BA2139</b>	0 986 467 760	<b>BA2065</b>	0 986 475 905	<b>BAW1914</b>
0 986 460 970	<b>BA2076</b>	0 986 467 841	<b>BA2101</b>	0 986 475 906	<b>BAW2600</b>
0 986 460 971	<b>BA2138</b>	0 986 468 350	<b>BA2124</b>	0 986 475 926	<b>BAW1914</b>
0 986 460 975	<b>BA2118</b>	0 986 468 380	<b>BA2034</b>	0 986 475 935	<b>BAW2002</b>
0 986 460 976	<b>BA2174</b>	0 986 468 701	<b>BA2121</b>	0 986 478 010	<b>BAR10151</b>
0 986 460 977	<b>BA2044</b>	0 986 468 870	<b>BA2132</b>	0 986 478 011	<b>BAR12106</b>
0 986 460 978	<b>BA2112</b>	0 986 468 871	<b>BA2133</b>	0 986 478 012	<b>BAR25138</b>
0 986 460 979	<b>BA2117</b>	0 986 468 873	<b>BA2132</b>	0 986 478 016	<b>BAR13160</b>
0 986 460 982	<b>BA2013</b>	0 986 468 890	<b>BA2131</b>	0 986 478 017	<b>BAR20123</b>
0 986 460 983	<b>BA2066</b>	0 986 469 191	<b>BA2050</b>	0 986 478 018	<b>BAR22118</b>
0 986 460 983	<b>BA2074</b>	0 986 469 390	<b>BA2134</b>	0 986 478 019	<b>BAR10178</b>
0 986 460 989	<b>BA2014</b>	0 986 469 410	<b>BA2029</b>	0 986 478 024	<b>BAR30107</b>
0 986 460 991	<b>BA2286</b>	0 986 469 790	<b>BA2025</b>	0 986 478 029	<b>BAR13167</b>
0 986 460 993	<b>BA2227</b>	0 986 469 810	<b>BA2030</b>	0 986 478 036	<b>BAR22122</b>
0 986 460 997	<b>BA2113</b>	0 986 469 860	<b>BA2055</b>	0 986 478 046	<b>BAR10187</b>
0 986 461 006	<b>BA2280</b>	0 986 469 860	<b>BA2083</b>	0 986 478 058	<b>BAR13137</b>
0 986 461 106	<b>BA2141</b>	0 986 469 960	<b>BA2054</b>	0 986 478 080	<b>BAR10152</b>
0 986 461 111	<b>BA2189</b>	0 986 475 024	<b>BAW1902</b>	0 986 478 081	<b>BAR13161</b>
0 986 461 117	<b>BA2048</b>	0 986 475 032	<b>BAW1705</b>	0 986 478 086	<b>BAR10204</b>
0 986 461 119	<b>BA2072</b>	0 986 475 039	<b>BAW2004</b>	0 986 478 095	<b>BAR12132</b>
0 986 461 122	<b>BA2232</b>	0 986 475 061	<b>BAW2005</b>	0 986 478 105	<b>BAR12116</b>
0 986 461 123	<b>BA2116</b>	0 986 475 062	<b>BAW2006</b>	0 986 478 113	<b>BAR24103</b>
0 986 461 126	<b>BA2274</b>	0 986 475 143	<b>BAW1904</b>	0 986 478 114	<b>BAR11137</b>
0 986 461 130	<b>BA2096</b>	0 986 475 260	<b>BAW1701</b>	0 986 478 124	<b>BAR21106</b>
0 986 461 141	<b>BA2115</b>	0 986 475 283	<b>BAW1902</b>	0 986 478 127	<b>BAR30101</b>
0 986 461 148	<b>BA2107</b>	0 986 475 290	<b>BAW1401</b>	0 986 478 128	<b>BAR22139</b>
0 986 461 661	<b>BA2041</b>	0 986 475 420	<b>BAW2501</b>	0 986 478 130	<b>BAR13166</b>
0 986 461 752	<b>BA2244</b>	0 986 475 433	<b>BAW1905</b>	0 986 478 132	<b>BAR10201</b>
0 986 461 753	<b>BA2049</b>	0 986 475 438	<b>BAW1501</b>	0 986 478 138	<b>BAR20114</b>
0 986 461 757	<b>BA2078</b>	0 986 475 502	<b>BAW2007</b>	0 986 478 143	<b>BAR10189</b>
0 986 461 763	<b>BA2066</b>	0 986 475 509	<b>BAW2201</b>	0 986 478 148	<b>BAR24112</b>



# Vergleichsliste

Liste des correspondances / Tabella di conversione codici / Lista de comparação /



Lista porównawcza numerów / Porovnávací seznam čísel

<b>BOSCH</b>		<b>BOSCH</b>		<b>BOSCH</b>	
0 986 478 160	<b>BAR24131</b>	0 986 478 470	<b>BAR32115</b>	0 986 478 704	<b>BAR10259</b>
0 986 478 166	<b>BAR24132</b>	0 986 478 475	<b>BAR08111</b>	0 986 478 716	<b>BAR10229</b>
0 986 478 170	<b>BAR24120</b>	0 986 478 479	<b>BAR09136</b>	0 986 478 718	<b>BAR24161</b>
0 986 478 174	<b>BAR21105</b>	0 986 478 480	<b>BAR10260</b>	0 986 478 730	<b>BAR24166</b>
0 986 478 187	<b>BAR12117</b>	0 986 478 481	<b>BAR09133</b>	0 986 478 734	<b>BAR24171</b>
0 986 478 188	<b>BAR09118</b>	0 986 478 482	<b>BAR22163</b>	0 986 478 745	<b>BAR24162</b>
0 986 478 192	<b>BAR20115</b>	0 986 478 485	<b>BAR26108</b>	0 986 478 747	<b>BAR12125</b>
0 986 478 197	<b>BAR28102</b>	0 986 478 492	<b>BAR09124</b>	0 986 478 759	<b>BAR10210</b>
0 986 478 199	<b>BAR10185</b>	0 986 478 493	<b>BAR24159</b>	0 986 478 797	<b>BAR24171</b>
0 986 478 200	<b>BAR16105</b>	0 986 478 494	<b>BAR28123</b>	0 986 478 810	<b>BAR22147</b>
0 986 478 201	<b>BAR16100</b>	0 986 478 498	<b>BAR26115</b>	0 986 478 812	<b>BAR26104</b>
0 986 478 219	<b>BAR22166</b>	0 986 478 501	<b>BAR10196</b>	0 986 478 830	<b>BAR24139</b>
0 986 478 227	<b>BAR24129</b>	0 986 478 502	<b>BAR20147</b>	0 986 478 831	<b>BAR26106</b>
0 986 478 241	<b>BAR18113</b>	0 986 478 504	<b>BAR10205</b>	0 986 478 842	<b>BAR24138</b>
0 986 478 246	<b>BAR08107</b>	0 986 478 511	<b>BAR12126</b>	0 986 478 843	<b>BAR18108</b>
0 986 478 255	<b>BAR09120</b>	0 986 478 513	<b>BAR22115</b>	0 986 478 845	<b>BAR25114</b>
0 986 478 262	<b>BAR12128</b>	0 986 478 515	<b>BAR20142</b>	0 986 478 846	<b>BAR24128</b>
0 986 478 265	<b>BAR24111</b>	0 986 478 532	<b>BAR26109</b>	0 986 478 847	<b>BAR13184</b>
0 986 478 267	<b>BAR10191</b>	0 986 478 533	<b>BAR18107</b>	0 986 478 848	<b>BAR22159</b>
0 986 478 268	<b>BAR20133</b>	0 986 478 533	<b>BAR22100</b>	0 986 478 849	<b>BAR22161</b>
0 986 478 270	<b>BAR20126</b>	0 986 478 542	<b>BAR15105</b>	0 986 478 852	<b>BAR22150</b>
0 986 478 273	<b>BAR08104</b>	0 986 478 545	<b>BAR25105</b>	0 986 478 853	<b>BAR22151</b>
0 986 478 276	<b>BAR20125</b>	0 986 478 546	<b>BAR24118</b>	0 986 478 855	<b>BAR12141</b>
0 986 478 288	<b>BAR12137</b>	0 986 478 548	<b>BAR22108</b>	0 986 478 856	<b>BAR12141</b>
0 986 478 298	<b>BAR26105</b>	0 986 478 550	<b>BAR08106</b>	0 986 478 859	<b>BAR13182</b>
0 986 478 301	<b>BAR22132</b>	0 986 478 552	<b>BAR22196</b>	0 986 478 861	<b>BAR22162</b>
0 986 478 305	<b>BAR11151</b>	0 986 478 555	<b>BAR10202</b>	0 986 478 863	<b>BAR12142</b>
0 986 478 308	<b>BAR20128</b>	0 986 478 561	<b>BAR10215</b>	0 986 478 867	<b>BAR25113</b>
0 986 478 314	<b>BAR22206</b>	0 986 478 564	<b>BAR10215</b>	0 986 478 868	<b>BAR09123</b>
0 986 478 317	<b>BAR28101</b>	0 986 478 569	<b>BAR13194</b>	0 986 478 869	<b>BAR22152</b>
0 986 478 318	<b>BAR22103</b>	0 986 478 570	<b>BAR19108</b>	0 986 478 870	<b>BAR18111</b>
0 986 478 319	<b>BAR12124</b>	0 986 478 571	<b>BAR22160</b>	0 986 478 871	<b>BAR12138</b>
0 986 478 319	<b>BAR12124</b>	0 986 478 571	<b>BAR22160</b>	0 986 478 871	<b>BAR12138</b>
0 986 478 325	<b>BAR09114</b>	0 986 478 578	<b>BAR22158</b>	0 986 478 872	<b>BAR25115</b>
0 986 478 327	<b>BAR24115</b>	0 986 478 584	<b>BAR25124</b>	0 986 478 873	<b>BAR10228</b>
0 986 478 329	<b>BAR13178</b>	0 986 478 588	<b>BAR25119</b>	0 986 478 874	<b>BAR12144</b>
0 986 478 331	<b>BAR10111</b>	0 986 478 588	<b>BAR25119</b>	0 986 478 874	<b>BAR12144</b>
0 986 478 332	<b>BAR10203</b>	0 986 478 590	<b>BAR24158</b>	0 986 478 875	<b>BAR22168</b>
0 986 478 342	<b>BAR11119</b>	0 986 478 593	<b>BAR28104</b>	0 986 478 876	<b>BAR28106</b>
0 986 478 343	<b>BAR12127</b>	0 986 478 593	<b>BAR22148</b>	0 986 478 876	<b>BAR10230</b>
0 986 478 344	<b>BAR10115</b>	0 986 478 598	<b>BAR22148</b>	0 986 478 877	<b>BAR10230</b>
0 986 478 370	<b>BAR20132</b>	0 986 478 603	<b>BAR26102</b>	0 986 478 881	<b>BAR24152</b>
0 986 478 420	<b>BAR10225</b>	0 986 478 603	<b>BAR26102</b>	0 986 478 882	<b>BAR10251</b>
0 986 478 421	<b>BAR10223</b>	0 986 478 604	<b>BAR09122</b>	0 986 478 882	<b>BAR10251</b>
0 986 478 423	<b>BAR25119</b>	0 986 478 608	<b>BAR09137</b>	0 986 478 883	<b>BAR25131</b>
0 986 478 425	<b>BAR10227</b>	0 986 478 608	<b>BAR09137</b>	0 986 478 884	<b>BAR10250</b>
0 986 478 426	<b>BAR20154</b>	0 986 478 609	<b>BAR12131</b>	0 986 478 884	<b>BAR10250</b>
0 986 478 433	<b>BAR16110</b>	0 986 478 610	<b>BAR08106</b>	0 986 478 887	<b>BAR13185</b>
0 986 478 434	<b>BAR24127</b>	0 986 478 611	<b>BAR10219</b>	0 986 478 888	<b>BAR10224</b>
0 986 478 436	<b>BAR10226</b>	0 986 478 611	<b>BAR10219</b>	0 986 478 888	<b>BAR10224</b>
0 986 478 438	<b>BAR18124</b>	0 986 478 613	<b>BAR18105</b>	0 986 478 892	<b>BAR22172</b>
0 986 478 439	<b>BAR10273</b>	0 986 478 616	<b>BAR26120</b>	0 986 478 893	<b>BAR25114</b>
0 986 478 449	<b>BAR25119</b>	0 986 478 618	<b>BAR22194</b>	0 986 478 896	<b>BAR20155</b>
0 986 478 461	<b>BAR10258</b>	0 986 478 618	<b>BAR22194</b>	0 986 478 896	<b>BAR20155</b>
0 986 478 464	<b>BAR08106</b>	0 986 478 620	<b>BAR10232</b>	0 986 478 897	<b>BAR24136</b>
0 986 478 467	<b>BAR25123</b>	0 986 478 621	<b>BAR18106</b>	0 986 478 897	<b>BAR24136</b>
0 986 478 468	<b>BAR26116</b>	0 986 478 621	<b>BAR18106</b>	0 986 478 898	<b>BAR10229</b>
		0 986 478 624	<b>BAR25110</b>	0 986 478 899	<b>BAR12149</b>
		0 986 478 626	<b>BAR10217</b>	0 986 478 899	<b>BAR12149</b>
		0 986 478 639	<b>BAR22197</b>	0 986 478 974	<b>BAR30109</b>
		0 986 478 641	<b>BAR10211</b>	0 986 478 975	<b>BAR22209</b>
		0 986 478 642	<b>BAR19107</b>	0 986 478 976	<b>BAR25113</b>
		0 986 478 654	<b>BAR24146</b>	0 986 478 979	<b>BAR26120</b>
		0 986 478 674	<b>BAR19109</b>	0 986 478 985	<b>BAR30113</b>
		0 986 478 683	<b>BAR11115</b>	0 986 478 986	<b>BAR10261</b>
				0 986 478 988	<b>BAR22151</b>

# Vergleichsliste

Liste des correspondances / Tabella di conversione codici / Lista de comparação /



Lista porównawcza numerów / Porovnávací seznam čísel

<b>BOSCH</b>		<b>BOSCH</b>		<b>BOSCH</b>	
0 986 478 989	<b>BAR24164</b>	0 986 487 276	<b>BAE5006</b>	0 986 494 000	<b>BA2250</b>
0 986 479 001	<b>BAR28129</b>	0 986 487 281	<b>BAE5006</b>	0 986 494 001	<b>BA2168</b>
0 986 479 030	<b>BAR28140</b>	0 986 487 291	<b>BAE5020</b>	0 986 494 002	<b>BA2150</b>
0 986 479 036	<b>BAR18137</b>	0 986 487 312	<b>BAE5024</b>	0 986 494 003	<b>BA2147</b>
0 986 479 037	<b>BAR26115</b>	0 986 487 317	<b>BAE5016</b>	0 986 494 004	<b>BA2315</b>
0 986 479 038	<b>BAR28141</b>	0 986 487 327	<b>BAE5013</b>	0 986 494 005	<b>BA2152</b>
0 986 479 039	<b>BAR28176</b>	0 986 487 330	<b>BAE5030</b>	0 986 494 006	<b>BA2167</b>
0 986 479 040	<b>BAR28142</b>	0 986 487 417	<b>BAE5027</b>	0 986 494 007	<b>BA2252</b>
0 986 479 041	<b>BAR10278</b>	0 986 487 422	<b>BAE5035</b>	0 986 494 008	<b>BA2171</b>
0 986 479 055	<b>BAR24181</b>	0 986 487 521	<b>BAE5023</b>	0 986 494 009	<b>BA2170</b>
0 986 479 056	<b>BAR20183</b>	0 986 487 522	<b>BAE5042</b>	0 986 494 010	<b>BA2018</b>
0 986 479 057	<b>BAR25137</b>	0 986 487 523	<b>BAE5031</b>	0 986 494 011	<b>BA2208</b>
0 986 479 058	<b>BAR25158</b>	0 986 487 524	<b>BAE5034</b>	0 986 494 012	<b>BA2184</b>
0 986 479 067	<b>BAR10285</b>	0 986 487 528	<b>BAE5026</b>	0 986 494 013	<b>BA2091</b>
0 986 479 068	<b>BAR12154</b>	0 986 487 536	<b>BAE5001</b>	0 986 494 014	<b>BA2197</b>
0 986 479 077	<b>BAR25148</b>	0 986 487 545	<b>BAE5037</b>	0 986 494 015	<b>BA2108</b>
0 986 479 078	<b>BAR28132</b>	0 986 487 550	<b>BAE5022</b>	0 986 494 016	<b>BA2164</b>
0 986 479 086	<b>BAR09138</b>	0 986 487 552	<b>BAE5019</b>	0 986 494 017	<b>BA2213</b>
0 986 479 087	<b>BAR09139</b>	0 986 487 553	<b>BAE5004</b>	0 986 494 018	<b>BA2205</b>
0 986 479 088	<b>BAR25145</b>	0 986 487 554	<b>BAE5012</b>	0 986 494 019	<b>BA2155</b>
0 986 479 097	<b>BAR22211</b>	0 986 487 555	<b>BAE5009</b>	0 986 494 021	<b>BA2160</b>
0 986 479 098	<b>BAR22210</b>	0 986 487 557	<b>BAE5041</b>	0 986 494 022	<b>BA2206</b>
0 986 479 106	<b>BAR12157</b>	0 986 487 559	<b>BAE5029</b>	0 986 494 023	<b>BA2220</b>
0 986 479 107	<b>BAR25141</b>	0 986 487 560	<b>BAE5038</b>	0 986 494 024	<b>BA2219</b>
0 986 479 113	<b>BAR25142</b>	0 986 487 561	<b>BAE5015</b>	0 986 494 025	<b>BA2200</b>
0 986 479 114	<b>BAR28136</b>	0 986 487 565	<b>BAE5007</b>	0 986 494 026	<b>BA2224</b>
0 986 479 115	<b>BAR30173</b>	0 986 487 570	<b>BAE5017</b>	0 986 494 027	<b>BA2214</b>
0 986 479 116	<b>BAR30101</b>	0 986 487 580	<b>BAE5036</b>	0 986 494 028	<b>BA2166</b>
0 986 479 138	<b>BAR10280</b>	0 986 487 585	<b>BAE5002</b>	0 986 494 030	<b>BA2303</b>
0 986 479 139	<b>BAR24159</b>	0 986 487 596	<b>BAE5010</b>	0 986 494 031	<b>BA2251</b>
0 986 479 140	<b>BAR24170</b>	0 986 487 598	<b>BAE5004</b>	0 986 494 032	<b>BA2235</b>
0 986 479 155	<b>BAR12158</b>	0 986 487 599	<b>BAE5036</b>	0 986 494 032	<b>BA2238</b>
0 986 479 157	<b>BAR25171</b>	0 986 487 600	<b>BAE5040</b>	0 986 494 032	<b>BA2258</b>
0 986 479 164	<b>BAR12171</b>	0 986 487 612	<b>BAE5028</b>	0 986 494 033	<b>BA2316</b>
0 986 479 165	<b>BAR12116</b>	0 986 487 614	<b>BAE5025</b>	0 986 494 034	<b>BA2317</b>
0 986 479 171	<b>BAR25162</b>	0 986 487 624	<b>BAE5039</b>	0 986 494 035	<b>BA2269</b>
0 986 479 187	<b>BAR24192</b>	0 986 487 633	<b>BAE5041</b>	0 986 494 036	<b>BA2245</b>
0 986 479 189	<b>BAR11152</b>	0 986 487 658	<b>BAE5033</b>	0 986 494 037	<b>BA2262</b>
0 986 479 190	<b>BAR20174</b>	0 986 487 660	<b>BAE5018</b>	0 986 494 038	<b>BA2229</b>
0 986 479 210	<b>BAR26122</b>	0 986 487 701	<b>BAE5032</b>	0 986 494 039	<b>BA2089</b>
0 986 479 212	<b>BAR22245</b>	0 986 490 260	<b>BA2161</b>	0 986 494 040	<b>BA2247</b>
0 986 479 236	<b>BAR10304</b>	0 986 490 500	<b>BA2095</b>	0 986 494 042	<b>BA2198</b>
0 986 479 247	<b>BAR12169</b>	0 986 490 550	<b>BA2027</b>	0 986 494 043	<b>BA2261</b>
0 986 479 314	<b>BAR24138</b>	0 986 490 640	<b>BA2125</b>	0 986 494 044	<b>BA2236</b>
0 986 479 402	<b>BAR12184</b>	0 986 490 800	<b>BA2020</b>	0 986 494 046	<b>BA2225</b>
0 986 487 002	<b>BAE5003</b>	0 986 490 800	<b>BA2036</b>	0 986 494 048	<b>BA2241</b>
0 986 487 008	<b>BAE5006</b>	0 986 490 891	<b>BA2036</b>	0 986 494 049	<b>BA2323</b>
0 986 487 203	<b>BAE5035</b>	0 986 491 030	<b>BA2035</b>	0 986 494 050	<b>BA2172</b>
0 986 487 228	<b>BAE5021</b>	0 986 491 050	<b>BA2033</b>	0 986 494 051	<b>BA2202</b>
0 986 487 252	<b>BAE5014</b>	0 986 491 441	<b>BA2052</b>	0 986 494 052	<b>BA2221</b>
0 986 487 263	<b>BAE5005</b>	0 986 491 700	<b>BA2040</b>	0 986 494 054	<b>BA2295</b>
0 986 487 264	<b>BAE5011</b>	0 986 491 730	<b>BA2026</b>	0 986 494 055	<b>BA2099</b>
0 986 487 266	<b>BAE5002</b>	0 986 491 900	<b>BA2137</b>	0 986 494 056	<b>BA2013</b>
0 986 487 270	<b>BAE5001</b>	0 986 492 020	<b>BA2146</b>	0 986 494 057	<b>BA2141</b>
0 986 487 272	<b>BAE5008</b>	0 986 492 090	<b>BA2043</b>	0 986 494 058	<b>BA2027</b>
0 986 487 274	<b>BAE5020</b>	0 986 493 790	<b>BA2110</b>	0 986 494 061	<b>BA2309</b>

# Vergleichsliste

Liste des correspondances / Tabella di conversione codici / Lista de comparação /



Lista porównawcza numerów / Porovnávací seznam čísel

<b>BOSCH</b>		<b>BOSCH</b>		<b>BOSCH</b>	
0 986 494 062	<b>BA2196</b>	0 986 560 953	<b>BA2060</b>	0 986 AB1 202	<b>BA2291</b>
0 986 494 063	<b>BA2272</b>	0 986 560 962	<b>BA2080</b>	0 986 AB1 241	<b>BA2123</b>
0 986 494 065	<b>BA2296</b>	0 986 560 963	<b>BA2081</b>	0 986 AB2 004	<b>BA2121</b>
0 986 494 070	<b>BA2283</b>	0 986 560 966	<b>BA2182</b>	0 986 AB2 176	<b>BA2274</b>
0 986 494 073	<b>BA2236</b>	0 986 560 971	<b>BA2138</b>	0 986 AB2 224	<b>BA2113</b>
0 986 494 074	<b>BA2289</b>	0 986 560 982	<b>BA2013</b>	0 986 AB2 309	<b>BA2249</b>
0 986 494 076	<b>BA2287</b>	0 986 560 983	<b>BA2066</b>	0 986 AB2 328	<b>BA2249</b>
0 986 494 081	<b>BA2263</b>	0 986 560 983	<b>BA2074</b>	0 986 AB2 455	<b>BA2110</b>
0 986 494 082	<b>BA2264</b>	0 986 560 997	<b>BA2113</b>	0 986 AB2 458	<b>BA2257</b>
0 986 494 085	<b>BA2310</b>	0 986 561 106	<b>BA2141</b>	0 986 AB2 461	<b>BA2115</b>
0 986 494 087	<b>BA2266</b>	0 986 561 117	<b>BA2048</b>	0 986 AB2 675	<b>BA2280</b>
0 986 494 092	<b>BA2256</b>	0 986 561 119	<b>BA2072</b>	0 986 AB3 802	<b>BA2155</b>
0 986 494 096	<b>BA2311</b>	0 986 561 122	<b>BA2232</b>	0 986 AB3 803	<b>BA2017</b>
0 986 494 099	<b>BA2300</b>	0 986 561 123	<b>BA2116</b>	0 986 AB3 805	<b>BA2038</b>
0 986 494 104	<b>BA2259</b>	0 986 561 130	<b>BA2096</b>	0 986 AB3 806	<b>BA2074</b>
0 986 494 105	<b>BA2298</b>	0 986 561 757	<b>BA2078</b>	0 986 AB3 808	<b>BA2214</b>
0 986 494 107	<b>BA2242</b>	0 986 561 763	<b>BA2055</b>	0 986 AB3 818	<b>BA2017</b>
0 986 494 108	<b>BA2243</b>	0 986 561 763	<b>BA2066</b>	0 986 AB3 834	<b>BA2294</b>
0 986 494 109	<b>BA2328</b>	0 986 561 764	<b>BA2140</b>	0 986 AB4 166	<b>BA2136</b>
0 986 494 110	<b>BA2265</b>	0 986 565 881	<b>BA2185</b>	0 986 AB4 166	<b>BA2137</b>
0 986 494 111	<b>BA2275</b>	0 986 566 302	<b>BA2162</b>	0 986 AB4 189	<b>BA2136</b>
0 986 494 113	<b>BA2283</b>	0 986 566 346	<b>BA2075</b>	0 986 AB4 297	<b>BA2207</b>
0 986 494 115	<b>BA2302</b>	0 986 566 346	<b>BA2077</b>	0 986 BB4 024	<b>BAR22161</b>
0 986 494 117	<b>BA2252</b>	0 986 566 350	<b>BA2056</b>	0 986 BB4 039	<b>BAR20133</b>
0 986 494 118	<b>BA2252</b>	0 986 566 402	<b>BA2144</b>	0 986 BB4 040	<b>BAR10187</b>
0 986 494 120	<b>BA2307</b>	0 986 566 683	<b>BA2032</b>	0 986 BB4 041	<b>BAR08107</b>
0 986 494 121	<b>BA2281</b>	0 986 566 683	<b>BA2212</b>	0 986 BB4 042	<b>BAR13178</b>
0 986 494 123	<b>BA2277</b>	0 986 566 693	<b>BA2028</b>	0 986 BB4 046	<b>BAR20142</b>
0 986 494 127	<b>BA2258</b>	0 986 566 693	<b>BA2031</b>	0 986 BB4 048	<b>BAR20115</b>
0 986 494 157	<b>BA2256</b>	0 986 566 700	<b>BA2031</b>	0 986 BB4 054	<b>BAR12106</b>
0 986 494 160	<b>BA2301</b>	0 986 566 700	<b>BA2038</b>	0 986 BB4 055	<b>BAR11119</b>
0 986 494 169	<b>BA2314</b>	0 986 567 411	<b>BA2024</b>	0 986 BB4 063	<b>BAR08104</b>
0 986 494 170	<b>BA2306</b>	0 986 567 720	<b>BA2023</b>	0 986 BB4 064	<b>BAR10111</b>
0 986 494 171	<b>BA2304</b>	0 986 567 760	<b>BA2064</b>	0 986 BB4 068	<b>BAR20132</b>
0 986 494 197	<b>BA2335</b>	0 986 567 760	<b>BA2065</b>	0 986 BB4 072	<b>BAR21106</b>
0 986 494 236	<b>BA2305</b>	0 986 567 841	<b>BA2101</b>	0 986 BB4 075	<b>BAR12125</b>
0 986 494 262	<b>BA2282</b>	0 986 568 380	<b>BA2033</b>	0 986 BB4 079	<b>BAR22148</b>
0 986 494 271	<b>BA2259</b>	0 986 568 380	<b>BA2034</b>	0 986 BB4 082	<b>BAR10219</b>
0 986 494 272	<b>BA2309</b>	0 986 568 701	<b>BA2121</b>	0 986 BB4 083	<b>BAR25105</b>
0 986 503 000	<b>BA2132</b>	0 986 568 870	<b>BA2132</b>	0 986 BB4 086	<b>BAR20125</b>
0 986 524 098	<b>BA2064</b>	0 986 568 871	<b>BA2133</b>	0 986 BB4 088	<b>BAR16110</b>
0 986 524 244	<b>BA2012</b>	0 986 568 890	<b>BA2131</b>	0 986 BB4 092	<b>BAR26106</b>
0 986 524 246	<b>BA2142</b>	0 986 569 390	<b>BA2134</b>	0 986 BB4 093	<b>BAR18108</b>
0 986 524 362	<b>BA2143</b>	0 986 569 410	<b>BA2029</b>	0 986 BB4 094	<b>BAR24127</b>
0 986 524 373	<b>BA2039</b>	0 986 569 790	<b>BA2025</b>	0 986 BB4 170	<b>BAR22168</b>
0 986 524 376	<b>BA2020</b>	0 986 569 860	<b>BA2055</b>	1 987 473 002	<b>BAV1025</b>
0 986 524 379	<b>BA2073</b>	0 986 569 860	<b>BA2083</b>	1 987 473 003	<b>BAV1040</b>
0 986 560 736	<b>BA2062</b>	0 986 590 550	<b>BA2027</b>	1 987 473 005	<b>BAV1041</b>
0 986 560 932	<b>BA2019</b>	0 986 590 640	<b>BA2125</b>	1 987 473 007	<b>BAV1026</b>
0 986 560 938	<b>BA2136</b>	0 986 590 800	<b>BA2020</b>	1 987 473 011	<b>BAV1024</b>
0 986 560 943	<b>BA2037</b>	0 986 590 800	<b>BA2036</b>	1 987 473 012	<b>BAV1052</b>
0 986 560 944	<b>BA2031</b>	0 986 591 050	<b>BA2033</b>	1 987 473 013	<b>BAV1053</b>
0 986 560 944	<b>BA2038</b>	0 986 591 730	<b>BA2026</b>	1 987 473 015	<b>BAV1038</b>
0 986 560 946	<b>BA2086</b>	0 986 592 020	<b>BA2146</b>	1 987 473 016	<b>BAV1039</b>
0 986 560 949	<b>BA2084</b>	0 986 592 090	<b>BA2043</b>	1 987 473 019	<b>BAV1023</b>
0 986 560 952	<b>BA2108</b>	0 986 593 790	<b>BA2110</b>	1 987 473 031	<b>BAV1056</b>

# Vergleichsliste

Liste des correspondances / Tabella di conversione codici / Lista de comparação /



Lista porównawcza numerów / Porovnávací seznam čísel

<b>BOSCH</b>		<b>BOSCH</b>		<b>BOSCH</b>	
1 987 473 032	<b>BAV1055</b>	1 987 476 400	<b>BAH0016</b>	F 026 000 036	<b>BA2072</b>
1 987 473 036	<b>BAV1048</b>	1 987 476 404	<b>BAH0026</b>	F 026 000 037	<b>BA2076</b>
1 987 473 045	<b>BAV1042</b>	1 987 476 406	<b>BAH0012</b>	F 026 000 038	<b>BA2082</b>
1 987 473 058	<b>BAV1044</b>	1 987 476 410	<b>BAH0014</b>	F 026 000 040	<b>BA2162</b>
1 987 474 901	<b>BAV1004</b>	1 987 476 415	<b>BAH0005</b>	F 026 000 041	<b>BA2023</b>
1 987 474 902	<b>BAV1001</b>	1 987 476 421	<b>BAH0024</b>	F 026 000 042	<b>BA2064</b>
1 987 474 903	<b>BAV1035</b>	1 987 476 427	<b>BAH0006</b>	F 026 000 042	<b>BA2065</b>
1 987 474 904	<b>BAV1007</b>	1 987 476 439	<b>BAH0018</b>	F 026 000 043	<b>BA2134</b>
1 987 474 909	<b>BAV1028</b>	1 987 476 441	<b>BAH0032</b>	F 026 000 044	<b>BA2055</b>
1 987 474 910	<b>BAV1003</b>	1 987 476 444	<b>BAH0001</b>	F 026 000 044	<b>BA2083</b>
1 987 474 911	<b>BAV1004</b>	1 987 476 600	<b>BAH0029</b>	F 026 000 046	<b>BA2027</b>
1 987 474 912	<b>BAV1001</b>	1 987 476 648	<b>BAH0023</b>	F 026 000 047	<b>BA2035</b>
1 987 474 913	<b>BAV1035</b>	1 987 476 696	<b>BAH0019</b>	F 026 000 048	<b>BA2147</b>
1 987 474 914	<b>BAV1007</b>	1 987 476 698	<b>BAH0022</b>	F 026 000 049	<b>BA2209</b>
1 987 474 925	<b>BAV1006</b>	1 987 476 713	<b>BAH0007</b>	F 026 000 050	<b>BA2148</b>
1 987 474 926	<b>BAV1005</b>	1 987 476 717	<b>BAH0013</b>	F 026 000 051	<b>BA2045</b>
1 987 474 927	<b>BAV1004</b>	1 987 476 746	<b>BAH0031</b>	F 026 000 052	<b>BA2047</b>
1 987 474 929	<b>BAV1027</b>	1 987 476 753	<b>BAH0017</b>	F 026 000 053	<b>BA2011</b>
1 987 474 930	<b>BAV1029</b>	1 987 476 760	<b>BAH0006</b>	F 026 000 055	<b>BA2064</b>
1 987 474 933	<b>BAV1049</b>	1 987 476 778	<b>BAH0028</b>	F 026 000 056	<b>BA2111</b>
1 987 474 934	<b>BAV1017</b>	1 987 476 858	<b>BAH0004</b>	F 026 000 056	<b>BA2292</b>
1 987 474 936	<b>BAV1030</b>	1 987 476 952	<b>BAH0033</b>	F 026 000 057	<b>BA2010</b>
1 987 474 940	<b>BAV1010</b>	F 026 000 000	<b>BA2142</b>	F 026 000 058	<b>BA2016</b>
1 987 474 942	<b>BAV1015</b>	F 026 000 001	<b>BA2315</b>	F 026 000 060	<b>BA2012</b>
1 987 474 943	<b>BAV1012</b>	F 026 000 002	<b>BA2152</b>	F 026 000 061	<b>BA2145</b>
1 987 474 944	<b>BAV1013</b>	F 026 000 003	<b>BA2171</b>	F 026 000 063	<b>BA2154</b>
1 987 474 945	<b>BAV1018</b>	F 026 000 004	<b>BA2140</b>	F 026 000 064	<b>BA2268</b>
1 987 474 946	<b>BAV1019</b>	F 026 000 004	<b>BA2151</b>	F 026 000 065	<b>BA2039</b>
1 987 474 954	<b>BAV1036</b>	F 026 000 005	<b>BA2153</b>	F 026 000 066	<b>BA2021</b>
1 987 474 956	<b>BAV1011</b>	F 026 000 006	<b>BA2151</b>	F 026 000 067	<b>BA2079</b>
1 987 474 957	<b>BAV1031</b>	F 026 000 007	<b>BA2144</b>	F 026 000 068	<b>BA2146</b>
1 987 474 958	<b>BAV1009</b>	F 026 000 008	<b>BA2108</b>	F 026 000 070	<b>BA2173</b>
1 987 474 960	<b>BAV1021</b>	F 026 000 009	<b>BA2053</b>	F 026 000 071	<b>BA2211</b>
1 987 474 966	<b>BAV1046</b>	F 026 000 010	<b>BA2084</b>	F 026 000 072	<b>BA2333</b>
1 987 474 969	<b>BAV1008</b>	F 026 000 011	<b>BA2203</b>	F 026 000 073	<b>BA2018</b>
1 987 474 972	<b>BAV1016</b>	F 026 000 012	<b>BA2136</b>	F 026 000 074	<b>BA2213</b>
1 987 474 973	<b>BAV1014</b>	F 026 000 014	<b>BA2108</b>	F 026 000 075	<b>BA2160</b>
1 987 474 994	<b>BAV1051</b>	F 026 000 015	<b>BA2141</b>	F 026 000 076	<b>BA2210</b>
1 987 474 997	<b>BAV1050</b>	F 026 000 016	<b>BA2144</b>	F 026 000 078	<b>BA2219</b>
1 987 476 078	<b>BAH0031</b>	F 026 000 017	<b>BA2132</b>	F 026 000 079	<b>BA2294</b>
1 987 476 170	<b>BAH0027</b>	F 026 000 018	<b>BA2132</b>	F 026 000 081	<b>BA2201</b>
1 987 476 171	<b>BAH0021</b>	F 026 000 019	<b>BA2131</b>	F 026 000 082	<b>BA2279</b>
1 987 476 173	<b>BAH0025</b>	F 026 000 020	<b>BA2029</b>	F 026 000 083	<b>BA2253</b>
1 987 476 208	<b>BAH0004</b>	F 026 000 021	<b>BA2276</b>	F 026 000 084	<b>BA2237</b>
1 987 476 216	<b>BAH0015</b>	F 026 000 022	<b>BA2072</b>	F 026 000 085	<b>BA2332</b>
1 987 476 217	<b>BAH0010</b>	F 026 000 022	<b>BA2073</b>	F 026 000 086	<b>BA2199</b>
1 987 476 220	<b>BAH0011</b>	F 026 000 023	<b>BA2100</b>	F 026 000 087	<b>BA2293</b>
1 987 476 221	<b>BAH0015</b>	F 026 000 024	<b>BA2226</b>	F 026 000 088	<b>BA2207</b>
1 987 476 230	<b>BAH0003</b>	F 026 000 025	<b>BA2089</b>	F 026 000 089	<b>BA2276</b>
1 987 476 231	<b>BAH0009</b>	F 026 000 025	<b>BA2090</b>	F 026 000 090	<b>BA2286</b>
1 987 476 232	<b>BAH0004</b>	F 026 000 026	<b>BA2176</b>	F 026 000 091	<b>BA2135</b>
1 987 476 295	<b>BAH0020</b>	F 026 000 027	<b>BA2197</b>	F 026 000 092	<b>BA2175</b>
1 987 476 334	<b>BAH0008</b>	F 026 000 029	<b>BA2200</b>	F 026 000 093	<b>BA2037</b>
1 987 476 382	<b>BAH0030</b>	F 026 000 030	<b>BA2194</b>	F 026 000 094	<b>BA2031</b>
1 987 476 393	<b>BAH0009</b>	F 026 000 031	<b>BA2062</b>	F 026 000 094	<b>BA2038</b>
1 987 476 396	<b>BAH0004</b>	F 026 000 035	<b>BA2286</b>	F 026 000 096	<b>BA2084</b>

# Vergleichsliste

Liste des correspondances / Tabella di conversione codici / Lista de comparação /



Lista porównawcza numerów / Porovnávací seznam čísel

<b>BOSCH</b>		<b>BOSCH</b>		<b>CITROEN</b>	
F 026 000 097	<b>BA2060</b>	F 026 002 157	<b>BAW2009</b>	4241 E7	<b>BAE5014</b>
F 026 000 098	<b>BA2322</b>	F 026 002 158	<b>BAW2008</b>	4241 E8	<b>BAE5020</b>
F 026 000 099	<b>BA2098</b>	F 026 002 171	<b>BAW2010</b>	4241 H4	<b>BAE5023</b>
F 026 000 100	<b>BA2106</b>	F 026 002 173	<b>BAW2500</b>	4241 H5	<b>BAE5042</b>
F 026 000 102	<b>BA2080</b>	F 026 002 181	<b>BAW1906</b>	4241 H7	<b>BAE5037</b>
F 026 000 103	<b>BA2081</b>	F 026 002 206	<b>BAW1909</b>	4241 J1	<b>BAE5002</b>
F 026 000 104	<b>BA2139</b>	F 026 002 207	<b>BAW1910</b>	4241 J5	<b>BAE5002</b>
F 026 000 105	<b>BA2076</b>	F 026 002 222	<b>BAW1913</b>	4241 J6	<b>BAE5020</b>
F 026 000 106	<b>BA2138</b>	F 026 002 223	<b>BAW1912</b>	4241 J8	<b>BAE5019</b>
F 026 000 107	<b>BA2044</b>	F 026 002 228	<b>BAW1909</b>	4241 J9	<b>BAE5020</b>
F 026 000 110	<b>BA2014</b>	F 026 002 229	<b>BAW1910</b>	4241 K6	<b>BAE5037</b>
F 026 000 111	<b>BA2227</b>	F 026 002 236	<b>BAW2005</b>	4241 K8	<b>BAE5019</b>
F 026 000 114	<b>BA2280</b>	F 026 002 237	<b>BAW2006</b>	4241 L2	<b>BAE5032</b>
F 026 000 116	<b>BA2048</b>	F 026 002 238	<b>BAW2005</b>	4241 L3	<b>BAE5020</b>
F 026 000 117	<b>BA2232</b>	F 026 002 239	<b>BAW2006</b>	4241 L6	<b>BAE5019</b>
F 026 000 118	<b>BA2116</b>	F 026 002 397	<b>BAW1903</b>	4241 N4	<b>BAE5042</b>
F 026 000 119	<b>BA2096</b>	F 026 002 454	<b>BAW1902</b>	4246 H9	<b>BAR20155</b>
F 026 000 119	<b>BA2097</b>	F 026 002 480	<b>BAW1907</b>	4246 J3	<b>BAR26104</b>
F 026 000 122	<b>BA2115</b>	F 026 002 482	<b>BAW2207</b>	4246 J9	<b>BAR18108</b>
F 026 000 123	<b>BA2280</b>	F 026 002 502	<b>BAW1702</b>	4246 K3	<b>BAR24138</b>
F 026 000 125	<b>BA2107</b>	F 026 002 564	<b>BAW1908</b>	4246 L4	<b>BAR24127</b>
F 026 000 127	<b>BA2244</b>	F 026 002 565	<b>BAW1902</b>	4246 L8	<b>BAR26106</b>
F 026 000 128	<b>BA2049</b>	F 026 002 567	<b>BAW2002</b>	4246 N5	<b>BAR16105</b>
F 026 000 129	<b>BA2078</b>	F 026 002 578	<b>BAW2500</b>	4246 P2	<b>BAR28136</b>
F 026 000 130	<b>BA2055</b>	F 026 002 581	<b>BAW2007</b>	4246 R4	<b>BAR13184</b>
F 026 000 130	<b>BA2066</b>			4246 R5	<b>BAR20133</b>
F 026 000 131	<b>BA2140</b>	<b>CHEVROLET</b>		4246 R9	<b>BAR13185</b>
F 026 000 132	<b>BA2050</b>			4246 W1	<b>BAR22194</b>
F 026 000 133	<b>BA2017</b>	90121445	<b>BAR20115</b>	4246 W2	<b>BAR26120</b>
F 026 000 136	<b>BA2134</b>	96316582	<b>BA2123</b>	4246 W6	<b>BAR20133</b>
F 026 000 139	<b>BA2075</b>	96574633	<b>BAR20115</b>	4246 X8	<b>BAR09137</b>
F 026 000 139	<b>BA2077</b>	NP1441	<b>BAE5011</b>	4246 Y1	<b>BAR24127</b>
F 026 000 140	<b>BA2056</b>	NP1464	<b>BAE5011</b>	4246 Y3	<b>BAR24138</b>
F 026 000 142	<b>BA2032</b>			4249 15	<b>BAR22194</b>
F 026 000 142	<b>BA2212</b>	<b>CHRYSLER</b>		4249 16	<b>BAR22194</b>
F 026 000 143	<b>BA2028</b>			4249 18	<b>BAR26120</b>
F 026 000 143	<b>BA2031</b>	0 5098 063AA	<b>BAR25110</b>	4249 27	<b>BAR24127</b>
F 026 000 144	<b>BA2028</b>	0 5098 064AA	<b>BAR28106</b>	4249 36	<b>BAR24138</b>
F 026 000 144	<b>BA2031</b>	0 5098 065AA	<b>BAR09114</b>	4249 53	<b>BAR09137</b>
F 026 000 144	<b>BA2038</b>	0 5098 066AA	<b>BAR09114</b>	4249 74	<b>BAR22197</b>
F 026 000 145	<b>BA2094</b>	0 5103 790AA	<b>BA2239</b>	4249 82	<b>BAR13184</b>
F 026 000 146	<b>BA2093</b>	0 5114 555AA	<b>BA2168</b>	4249 83	<b>BAR22194</b>
F 026 000 148	<b>BA2033</b>	0 5126 300AA	<b>BA2164</b>	4249 84	<b>BAR26120</b>
F 026 000 148	<b>BA2034</b>	0 5139 218AA	<b>BA2168</b>	4249 99	<b>BAR24127</b>
F 026 000 150	<b>BA2121</b>	0 5139 902AA	<b>BA2164</b>	4249 G1	<b>BAR22194</b>
F 026 000 151	<b>BA2132</b>	0 5143 633AA	<b>BA2163</b>	4249 H2	<b>BAR24138</b>
F 026 000 154	<b>BA2030</b>	5098 063AA	<b>BAR25110</b>	4249 J6	<b>BAR26120</b>
F 026 000 155	<b>BA2095</b>	5098 064AA	<b>BAR28106</b>	4249 K3	<b>BAR24127</b>
F 026 000 156	<b>BA2020</b>	5098 065AA	<b>BAR09114</b>	4249 L2	<b>BAR22197</b>
F 026 000 156	<b>BA2036</b>	5098 066AA	<b>BAR09114</b>	4251 10	<b>BA2047</b>
F 026 000 158	<b>BA2033</b>	5103 790AA	<b>BA2239</b>	4251 17	<b>BA2045</b>
F 026 000 159	<b>BA2052</b>	5114 555AA	<b>BA2168</b>	4251 19	<b>BA2046</b>
F 026 000 160	<b>BA2026</b>	5126 300AA	<b>BA2164</b>	4251 26	<b>BA2079</b>
F 026 000 161	<b>BA2137</b>	5139 218AA	<b>BA2168</b>	4251 28	<b>BA2100</b>
F 026 000 162	<b>BA2146</b>	5139 902AA	<b>BA2164</b>	4251 37	<b>BA2083</b>
F 026 000 163	<b>BA2043</b>	5143 633AA	<b>BA2163</b>	4251 38	<b>BA2151</b>

# Vergleichsliste

Liste des correspondances / Tabella di conversione codici / Lista de comparação /



Lista porównawcza numerów / Porovnávací seznam čísel

CITROEN		CITROEN		CITROEN	
4251 39	BA2151	4254 61	BA2275	95 661 749	BAR08106
4251 44	BA2016	4254 62	BA2275	95 661 810	BAR08107
4251 46	BA2076	4254 63	BA2328	95 661 871	BA2020
4251 47	BA2083	4254 67	BA2017	95 666 970	BA2074
4251 50	BA2079	4254 68	BA2323	95 666 971	BA2076
4251 55	BA2021	4254 69	BA2265	95 666 973	BA2106
4251 56	BA2078	4254 71	BA2229	95 667 764	BA2024
4251 69	BA2090	4254 75	BA2214	95 667 786	BA2078
4251 70	BA2151	4254 76	BA2300	95 667 788	BA2106
4251 83	BA2106	4402 70	BAW2501	95 667 809	BAR20133
4251 92	BA2090	4402 90	BAW1909	95 667 811	BAR09122
4251 97	BA2076	4402 91	BAW1910	96 012 770	BAR08106
4252 05	BA2090	4402 93	BAW1913	96 070 525	BAR10187
4252 18	BA2214	4402 94	BAW1912	ZF 07 568 440	BAR16105
4252 26	BA2325	4402 A3	BAW2600	ZF 09 938 868	BAW2501
4252 31	BA2285	4402 A5	BAW2800	ZF 93 500 520	BAR16105
4252 33	BA2017	4402 A7	BAW1906		
4252 35	BA2229	4402 A8	BAW2001	<b>DACIA</b>	
4252 36	BA2282	4402 C3	BAW2001		
4252 40	BA2214	4402 C6	BAW2205	41 06 021 92R	BA2023
4252 41	BA2017	4402 E4	BAW2600	41 06 047 75R	BA2284
4252 43	BA2241	91 508 338	BAR10187	41 06 084 81R	BA2284
4252 45	BA2324	91 517 695	BAR20132	60 01 547 619	BA2023
4252 47	BA2323	94 04 402 708	BAW2501	60 01 547 630	BAE5002
4252 53	BA2289	95 027 199	BAR08107	60 01 547 632	BAW1704
4252 58	BA2282	95 589 273	BA2056	60 01 547 683	BAR12171
4252 74	BA2076	95 608 853	BAW1909	60 01 547 684	BAR12116
4252 91	BA2078	95 608 854	BAW1910	60 01 547 911	BA2023
4253 25	BA2300	95 616 818	BA2036	60 01 548 578	BAR21106
4253 28	BA2296	95 619 515	BAE5014	60 01 549 211	BAR12116
4253 30	BA2214	95 619 549	BA2096	60 01 549 803	BA2335
4253 31	BA2229	95 619 550	BA2097	60 01 551 410	BAW1707
4253 42	BA2214	95 624 484	BA2056	77 01 047 838	BAW1707
4253 45	BA2282	95 624 970	BA2024	77 01 070 668	BAW1907
4253 56	BA2275	95 632 048	BAR20133	77 01 206 339	BAR21106
4253 58	BA2275	95 646 300	BA2097	77 01 208 111	BAE5002
4253 60	BA2265	95 647 611	BA2096	77 01 208 252	BAR12171
4253 64	BA2329	95 647 733	BA2020	77 01 208 265	BA2023
4253 66	BA2329	95 650 936	BA2096	77 01 209 164	BA2284
4253 68	BA2330	95 650 937	BA2096	77 01 209 639	BA2023
4253 69	BA2282	95 650 938	BA2096	77 01 210 142	BA2023
4253 70	BA2229	95 653 213	BAE5014	77 11 130 071	BA2023
4253 74	BA2328	95 654 085	BA2106		
4253 84	BA2282	95 655 344	BAE5014	<b>DAEWOO</b>	
4253 88	BA2249	95 658 557	BA2048		
4253 99	BA2300	95 658 617	BA2097	11046948322	BA2136
4254 05	BA2235	95 659 340	BA2066	11046948372	BA2136
4254 23	BA2214	95 659 341	BA2076	11046952012	BA2137
4254 51	BA2045	95 659 353	BA2020	90121445	BAR20115
4254 52	BA2046	95 659 616	BA2074	90235420	BAW1705
4254 53	BA2047	95 659 642	BA2106	90235422	BAW1904
4254 54	BA2079	95 659 671	BAE5020	96179110	BAR24115
4254 55	BA2325	95 659 673	BAW1913	96273708	BA2123
4254 57	BA2285	95 659 674	BAW1912	96281937	BA2122
4254 58	BA2241	95 661 747	BAR20132	96281939	BA2122
4254 59	BA2324	95 661 748	BAR10187	96281945	BA2123

# Vergleichsliste

Liste des correspondances / Tabella di conversione codici / Lista de comparação /



Lista porównawcza numerów / Porovnávací seznam čísel

DAEWOO		FERODO		FERODO	
96316582	<b>BA2123</b>	DDF1080	<b>BAR22206</b>	DDF1263	<b>BAR28142</b>
96430417	<b>BAE5011</b>	DDF1082	<b>BAR25119</b>	DDF1276	<b>BAR12158</b>
96574633	<b>BAR20115</b>	DDF1083	<b>BAR10226</b>	DDF1279	<b>BAR20115</b>
NP1441	<b>BAE5011</b>	DDF1096	<b>BAR21106</b>	DDF128	<b>BAR10178</b>
NP1464	<b>BAE5011</b>	DDF1101	<b>BAR24171</b>	DDF1280	<b>BAR22209</b>
S4510011	<b>BA2122</b>	DDF1102	<b>BAR24158</b>	DDF1286	<b>BAR22211</b>
S4520005	<b>BAE5011</b>	DDF1111	<b>BAR09136</b>	DDF1288	<b>BAR12157</b>
S4520006	<b>BAE5011</b>	DDF1118	<b>BAR25123</b>	DDF1296	<b>BAR26115</b>
		DDF1120	<b>BAR32115</b>	DDF1305	<b>BAR25158</b>
<b>DAF</b>		DDF1123	<b>BAR24171</b>	DDF1306	<b>BAR12169</b>
		DDF1124	<b>BAR24158</b>	DDF1307	<b>BAR10278</b>
110 634	<b>BAH0010</b>	DDF1125	<b>BAR24161</b>	DDF132	<b>BAR08107</b>
		DDF1126	<b>BAR12154</b>	DDF1361	<b>BAR10211</b>
<b>FERODO</b>		DDF1129	<b>BAR11152</b>	DDF1362	<b>BAR08111</b>
		DDF1130	<b>BAR20174</b>	DDF1366	<b>BAR20171</b>
DDF003	<b>BAR10185</b>	DDF1131	<b>BAR24166</b>	DDF137	<b>BAR10111</b>
DDF035	<b>BAR11115</b>	DDF1135	<b>BAR25110</b>	DDF1383	<b>BAR10285</b>
DDF042	<b>BAR10151</b>	DDF1136	<b>BAR28106</b>	DDF140	<b>BAR11119</b>
DDF048	<b>BAR13160</b>	DDF1140	<b>BAR22194</b>	DDF1401	<b>BAR26138</b>
DDF053	<b>BAR11137</b>	DDF1152	<b>BAR26120</b>	DDF141	<b>BAR12127</b>
DDF055	<b>BAR12116</b>	DDF1154	<b>BAR22163</b>	DDF141-1	<b>BAR12127</b>
DDF058	<b>BAR20114</b>	DDF1155	<b>BAR09133</b>	DDF1417	<b>BAR09139</b>
DDF059	<b>BAR10187</b>	DDF1156	<b>BAR25137</b>	DDF1419	<b>BAR09138</b>
DDF062	<b>BAR13167</b>	DDF1158	<b>BAR13194</b>	DDF151	<b>BAR20115</b>
DDF063	<b>BAR16105</b>	DDF1159	<b>BAR26115</b>	DDF158	<b>BAR20125</b>
DDF070	<b>BAR08104</b>	DDF116	<b>BAR13161</b>	DDF159	<b>BAR20126</b>
DDF071	<b>BAR13137</b>	DDF1163	<b>BAR26122</b>	DDF160	<b>BAR24103</b>
DDF080	<b>BAR10189</b>	DDF1164	<b>BAR18137</b>	DDF175	<b>BAR20123</b>
DDF095	<b>BAR16100</b>	DDF1165	<b>BAR28136</b>	DDF1784	<b>BAR12184</b>
DDF1000	<b>BAR13184</b>	DDF1166	<b>BAR30113</b>	DDF182	<b>BAR22122</b>
DDF1003	<b>BAR22152</b>	DDF1170	<b>BAR24127</b>	DDF183	<b>BAR24112</b>
DDF1006	<b>BAR22148</b>	DDF1171	<b>BAR24138</b>	DDF185	<b>BAR28102</b>
DDF1010	<b>BAR24128</b>	DDF1174	<b>BAR25138</b>	DDF188	<b>BAR24111</b>
DDF1011	<b>BAR18111</b>	DDF1177	<b>BAR10260</b>	DDF192	<b>BAR20133</b>
DDF1012	<b>BAR12138</b>	DDF1178	<b>BAR09137</b>	DDF193	<b>BAR22118</b>
DDF1013	<b>BAR22161</b>	DDF1190	<b>BAR10259</b>	DDF205	<b>BAR13178</b>
DDF1014	<b>BAR25115</b>	DDF1202	<b>BAR30107</b>	DDF206	<b>BAR24115</b>
DDF1028	<b>BAR10273</b>	DDF1204	<b>BAR28132</b>	DDF207	<b>BAR20128</b>
DDF103	<b>BAR12106</b>	DDF1217	<b>BAR28129</b>	DDF208	<b>BAR10196</b>
DDF1033	<b>BAR10258</b>	DDF1218	<b>BAR25145</b>	DDF210	<b>BAR12124</b>
DDF1034	<b>BAR12144</b>	DDF122	<b>BAR09118</b>	DDF211	<b>BAR22103</b>
DDF1035	<b>BAR22168</b>	DDF1221	<b>BAR25113</b>	DDF214	<b>BAR20132</b>
DDF1036	<b>BAR26116</b>	DDF1223	<b>BAR22210</b>	DDF215	<b>BAR12125</b>
DDF104	<b>BAR10152</b>	DDF1225	<b>BAR25162</b>	DDF220	<b>BAR22147</b>
DDF1041	<b>BAR24152</b>	DDF1232	<b>BAR10261</b>	DDF222	<b>BAR28101</b>
DDF1042	<b>BAR25131</b>	DDF1233	<b>BAR09124</b>	DDF224	<b>BAR09114</b>
DDF1043	<b>BAR10251</b>	DDF1234	<b>BAR10280</b>	DDF224C-1	<b>BAR09114</b>
DDF1044	<b>BAR10250</b>	DDF1236	<b>BAR25148</b>	DDF227	<b>BAR18107</b>
DDF1056	<b>BAR11151</b>	DDF124	<b>BAR12117</b>	DDF239	<b>BAR10191</b>
DDF1063	<b>BAR24158</b>	DDF1242	<b>BAR30173</b>	DDF240	<b>BAR11119</b>
DDF1066	<b>BAR22160</b>	DDF1251	<b>BAR12149</b>	DDF244	<b>BAR08106</b>
DDF1067	<b>BAR24162</b>	DDF1252	<b>BAR28141</b>	DDF248	<b>BAR12126</b>
DDF1068	<b>BAR24159</b>	DDF1252	<b>BAR28176</b>	DDF249	<b>BAR10202</b>
DDF1072	<b>BAR22172</b>	DDF1256	<b>BAR30109</b>	DDF255	<b>BAR26105</b>
DDF1073	<b>BAR19108</b>	DDF1260	<b>BAR20183</b>	DDF258	<b>BAR22115</b>
DDF1078	<b>BAR28123</b>	DDF1261	<b>BAR25142</b>	DDF266	<b>BAR10203</b>

# Vergleichsliste

Liste des correspondances / Tabella di conversione codici / Lista de comparação /

Lista porównawcza numerów / Porovnávací seznam čísel



FERODO		FERODO		FERODO	
DDF267	BAR10215	DDF819C-1	BAR09114	DRF1156	BAR25137
DDF281	BAR10115	DDF830	BAR10210	DRF116	BAR13161
DDF318	BAR13166	DDF831	BAR19107	DRF1163	BAR26122
DDF319	BAR22108	DDF834	BAR22159	DRF1174	BAR25138
DDF320	BAR25105	DDF835	BAR10227	DRF1177	BAR10260
DDF321	BAR10201	DDF836	BAR20154	DRF128	BAR10178
DDF324	BAR15105	DDF841	BAR26106	DRF132	BAR08107
DDF329	BAR10205	DDF842	BAR20155	DRF137	BAR10111
DDF330	BAR28104	DDF845	BAR12141	DRF140	BAR11119
DDF331	BAR10204	DDF846	BAR25114	DRF141	BAR12127
DDF332	BAR22100	DDF847	BAR10223	DRF151	BAR20115
DDF362	BAR10219	DDF848	BAR24131	DRF158	BAR20125
DDF364	BAR24120	DDF849	BAR24132	DRF175	BAR20123
DDF369	BAR24171	DDF860	BAR22162	DRF183	BAR24112
DDF370	BAR24112	DDF861	BAR10228	DRF192	BAR20133
DDF389	BAR19109	DDF869	BAR10230	DRF193	BAR22118
DDF393	BAR22166	DDF870	BAR24139	DRF205	BAR13178
DDF427	BAR24118	DDF875	BAR13182	DRF206	BAR24115
DDF442	BAR12137	DDF885	BAR24136	DRF207	BAR20128
DDF464	BAR26109	DDF886	BAR10229	DRF208	BAR10196
DDF490	BAR09122	DDF887	BAR20147	DRF210	BAR12124
DDF492	BAR21105	DDF927	BAR22151	DRF211	BAR22103
DDF496	BAR24129	DDF928	BAR22150	DRF214	BAR20132
DDF497	BAR18113	DDF929	BAR09123	DRF220	BAR22147
DDF517	BAR22139	DDF930	BAR25113	DRF222	BAR28101
DDF521	BAR20142	DDF931	BAR12142	DRF244	BAR08106
DDF539	BAR09120	DDF932	BAR16110	DRF248	BAR12126
DDF540	BAR12128	DDF952	BAR10224	DRF249	BAR10202
DDF543	BAR10261	DDF963	BAR10217	DRF258	BAR22115
DDF553	BAR12132	DDF965	BAR10211	DRF266	BAR10203
DDF562	BAR18105	DDF985	BAR28106	DRF281	BAR10115
DDF588	BAR22132	DDF992	BAR25124	DRF319	BAR22108
DDF605	BAR26102	DDF995	BAR13185	DRF321	BAR10201
DDF606	BAR30101	DRF042	BAR10151	DRF324	BAR15105
DDF620	BAR25124	DRF055	BAR12116	DRF329	BAR10205
DDF698	BAR12131	DRF059	BAR10187	DRF331	BAR10204
DDF722	BAR26108	DRF070	BAR08104	DRF332	BAR22100
DDF741	BAR24146	DRF1003	BAR22152	DRF364	BAR24120
DDF758	BAR18108	DRF1006	BAR22148	DRF492	BAR21105
DDF760	BAR26104	DRF1014	BAR25115	DRF497	BAR18113
DDF762	BAR22197	DRF103	BAR12106	DRF517	BAR22139
DDF766	BAR20147	DRF1033	BAR10258	DRF521	BAR20142
DDF767	BAR24127	DRF1035	BAR22168	DRF553	BAR12132
DDF768	BAR24138	DRF104	BAR10152	DRF588	BAR22132
DDF794	BAR22158	DRF1066	BAR22160	DRF605	BAR26102
DDF795	BAR10232	DRF1072	BAR22172	DRF606	BAR30101
DDF796	BAR22161	DRF1073	BAR19108	DRF620	BAR25124
DDF798	BAR21106	DRF1078	BAR28123	DRF762	BAR22197
DDF809	BAR10115	DRF1082	BAR25119	DRF766	BAR20147
DDF810	BAR25119	DRF1096	BAR21106	DRF794	BAR22158
DDF811	BAR10226	DRF1118	BAR25123	DRF795	BAR10232
DDF812	BAR18106	DRF1123	BAR24171	DRF798	BAR21106
DDF814	BAR10225	DRF1124	BAR24158	DRF810	BAR25119
DDF817	BAR25110	DRF1140	BAR22194	DRF812	BAR18106
DDF819	BAR09114	DRF1154	BAR22163	DRF817	BAR25110
DDF819-1	BAR09114	DRF1155	BAR09133	DRF830	BAR10210



# Vergleichsliste

Liste des correspondances / Tabella di conversione codici / Lista de comparação /



Lista porównawcza numerów / Porovnávací seznam čísel

FERODO		FERODO		FERODO	
DRF831	BAR19107	FCR230A	BAR12142	FDB1276	BA2084
DRF834	BAR22159	FCV1043	BA2239	FDB1285	BA2244
DRF841	BAR26106	FCV239	BA2101	FDB1288	BA2153
DRF845	BAR12141	FCV501	BA2124	FDB1289	BA2160
DRF870	BAR24139	FDB1000	BA2047	FDB129	BA2109
DRF927	BAR22151	FDB1002	BA2079	FDB1292	BA2320
DRF928	BAR22150	FDB1024	BA2181	FDB1293	BA2173
DRF929	BAR09123	FDB1038	BA2149	FDB1294	BA2197
DRF952	BAR10224	FDB1039	BA2233	FDB1295	BA2211
DRF985	BAR28106	FDB1040	BA2142	FDB1299	BA2315
DRF995	BAR13185	FDB1040B	BA2142	FDB1300	BA2108
FCP1063S	BA2016	FDB1044	BA2250	FDB1301	BA2053
FCP1081S	BA2144	FDB1045	BA2215	FDB1303	BA2176
FCP1082S	BA2146	FDB1049	BA2150	FDB1304	BA2091
FCP1094S	BA2154	FDB1050	BA2168	FDB1304A	BA2091
FCP1101S	BA2152	FDB1054	BA2145	FDB1305	BA2290
FCP116S	BA2185	FDB1055	BA2147	FDB1306	BA2216
FCP1378S	BA2089	FDB1056	BA2143	FDB1310	BA2213
FCP206S	BA2144	FDB1056B	BA2143	FDB1311	BA2213
FCP256S	BA2188	FDB1062	BA2015	FDB1312	BA2018
FCP296S	BA2189	FDB1063	BA2016	FDB1318	BA2209
FCP308S	BA2121	FDB1066	BA2072	FDB1318B	BA2209
FCP370S	BA2034	FDB1067	BA2137	FDB1319	BA2208
FCP385S	BA2131	FDB1068	BA2207	FDB1319B	BA2208
FCP392S	BA2133	FDB1071	BA2141	FDB1322	BA2206
FCP393S	BA2055	FDB1072	BA2141	FDB1323	BA2172
FCP406S	BA2050	FDB1073	BA2169	FDB1324	BA2271
FCP409S	BA2035	FDB1075	BA2170	FDB1337	BA2123
FCP415S	BA2029	FDB1081	BA2144	FDB1338	BA2081
FCP434S	BA2036	FDB1082	BA2146	FDB1339	BA2080
FCP524S	BA2033	FDB1083	BA2017	FDB1349	BA2271
FCP534S	BA2060	FDB1083	BA2032	FDB1357	BA2176
FCP535S	BA2097	FDB1085	BA2050	FDB1358	BA2220
FCP541S	BA2032	FDB1093	BA2268	FDB1378	BA2089
FCP578S	BA2054	FDB1094	BA2154	FDB1380	BA2225
FCP584S	BA2137	FDB1095	BA2226	FDB1382	BA2253
FCP590S	BA2135	FDB1096	BA2273	FDB1383	BA2279
FCP617S	BA2084	FDB1101	BA2152	FDB1384	BA2237
FCP725S	BA2108	FDB1103	BA2113	FDB1392	BA2294
FCP732S	BA2136	FDB1109	BA2100	FDB1393	BA2203
FCP774S	BA2037	FDB1112	BA2021	FDB1394	BA2199
FCP775S	BA2038	FDB1113	BA2035	FDB1395	BA2293
FCP779S	BA2125	FDB1116	BA2122	FDB1396	BA2325
FCP845S	BA2023	FDB1117	BA2095	FDB1398	BA2155
FCP850S	BA2053	FDB1124	BA2022	FDB1399	BA2214
FCP857S	BA2167	FDB1131	BA2322	FDB1400	BA2191
FCP876S	BA2140	FDB1132	BA2202	FDB1401	BA2192
FCP876S	BA2151	FDB1135	BA2090	FDB1407	BA2246
FCP881S	BA2075	FDB1139	BA2232	FDB1414	BA2221
FCR116A	BAR16100	FDB114	BA2082	FDB1416	BA2225
FCR153A	BAR22161	FDB116	BA2185	FDB1420	BA2219
FCR154A	BAR16110	FDB1160	BA2332	FDB1423	BA2260
FCR191A	BAR22196	FDB1162	BA2217	FDB1424	BA2210
FCR227A	BAR12142	FDB1163	BA2171	FDB1425	BA2224
FCR228A	BAR22161	FDB1167	BA2148	FDB1426	BA2184
FCR229A	BAR16110	FDB1168	BA2151	FDB1428	BA2177

# Vergleichsliste

Liste des correspondances / Tabella di conversione codici / Lista de comparação /



Lista porównawcza numerów / Porovnávací seznam čísel

FERODO		FERODO		FERODO	
FDB1429	BA2177	FDB1648	BA2295	FDB343	BA2031
FDB1439	BA2278	FDB1649	BA2326	FDB346	BA2065
FDB1441	BA2288	FDB1654	BA2231	FDB351	BA2064
FDB1451	BA2198	FDB1661	BA2204	FDB351B	BA2064
FDB1452	BA2251	FDB1662	BA2298	FDB370	BA2034
FDB1453	BA2261	FDB1668	BA2172	FDB370B	BA2034
FDB1458	BA2116	FDB1675	BA2258	FDB372	BA2257
FDB1458	BA2121	FDB1676	BA2272	FDB385	BA2131
FDB1461	BA2262	FDB1679	BA2280	FDB392	BA2133
FDB1463	BA2205	FDB1717	BA2172	FDB393	BA2055
FDB1467	BA2299	FDB1738	BA2268	FDB393A	BA2055
FDB1469	BA2303	FDB173E	BA2134	FDB393C	BA2055
FDB1476	BA2229	FDB173G	BA2134	FDB398	BA2030
FDB1476	BA2289	FDB1747	BA2307	FDB4035	BA2335
FDB1478	BA2241	FDB1748	BA2240	FDB406	BA2050
FDB1479	BA2324	FDB1749	BA2266	FDB409	BA2035
FDB1480	BA2323	FDB1750	BA2310	FDB413	BA2178
FDB1481	BA2228	FDB1751	BA2311	FDB414	BA2086
FDB1482	BA2200	FDB1753	BA2276	FDB415	BA2029
FDB1483	BA2167	FDB1753	BA2286	FDB419	BA2132
FDB1491	BA2212	FDB1766	BA2235	FDB428	BA2056
FDB1493	BA2263	FDB1770	BA2212	FDB428B	BA2056
FDB1493	BA2264	FDB1781	BA2023	FDB434	BA2020
FDB1494	BA2264	FDB1782	BA2220	FDB435	BA2111
FDB1496	BA2269	FDB1784	BA2300	FDB440	BA2077
FDB1497	BA2318	FDB1787	BA2285	FDB455	BA2036
FDB1499	BA2267	FDB1788	BA2017	FDB517	BA2025
FDB1500	BA2272	FDB1790	BA2296	FDB520	BA2187
FDB1515	BA2254	FDB1806	BA2308	FDB520A	BA2187
FDB1516	BA2247	FDB1807	BA2309	FDB524	BA2033
FDB1518	BA2201	FDB1865	BA2316	FDB525	BA2095
FDB1519	BA2321	FDB1866	BA2317	FDB527	BA2040
FDB1520	BA2236	FDB1867	BA2053	FDB534	BA2060
FDB1521	BA2194	FDB1885	BA2287	FDB535	BA2096
FDB1526	BA2218	FDB1917	BA2313	FDB535	BA2097
FDB1534	BA2190	FDB192	BA2185	FDB537	BA2077
FDB1540	BA2238	FDB1920	BA2256	FDB540	BA2043
FDB1542	BA2282	FDB1931	BA2258	FDB541	BA2017
FDB1544	BA2230	FDB1944	BA2302	FDB541	BA2032
FDB1556	BA2285	FDB1946	BA2283	FDB55	BA2126
FDB1573	BA2270	FDB2	BA2162	FDB556	BA2112
FDB1574	BA2331	FDB206	BA2144	FDB558	BA2076
FDB1580	BA2278	FDB212	BA2144	FDB576	BA2110
FDB1593	BA2266	FDB222	BA2052	FDB577	BA2125
FDB1594	BA2234	FDB239	BA2101	FDB578	BA2054
FDB1606	BA2291	FDB2-410	BA2162	FDB584	BA2137
FDB1617	BA2284	FDB256	BA2188	FDB586	BA2098
FDB1628	BA2245	FDB275	BA2039	FDB589	BA2146
FDB1629	BA2259	FDB287	BA2024	FDB590	BA2135
FDB163	BA2193	FDB29	BA2062	FDB603	BA2011
FDB1630	BA2072	FDB296	BA2189	FDB608	BA2012
FDB1635	BA2155	FDB2H	BA2162	FDB610	BA2039
FDB1636	BA2196	FDB2M	BA2162	FDB610B	BA2039
FDB1637	BA2017	FDB308	BA2121	FDB613	BA2010
FDB1640	BA2255	FDB328	BA2093	FDB615	BA2106
FDB1641	BA2195	FDB343	BA2028	FDB617	BA2084

# Vergleichsliste

Liste des correspondances / Tabella di conversione codici / Lista de comparação /



Lista porównawcza numerów / Porovnávací seznam čísel

FERODO		FERODO		FERODO	
FDB619	BA2099	FDB878	BA2107	FDS1469	BA2303
FDB644	BA2161	FDB880	BA2013	FDS1499	BA2267
FDB646	BA2182	FDB881	BA2075	FDS1500	BA2272
FDB660	BA2026	FDB884	BA2139	FDS1573	BA2270
FDB669	BA2027	FDB909	BA2119	FDS173	BA2134
FDB671	BA2014	FDB913	BA2286	FDS1807	BA2309
FDB675	BA2181	FDB925	BA2073	FDS212	BA2144
FDB678	BA2114	FDB925B	BA2073	FDS256	BA2188
FDB681	BA2244	FDB939	BA2110	FDS308	BA2121
FDB686	BA2175	FDB941	BA2068	FDS370	BA2034
FDB687	BA2020	FDB950	BA2118	FDS392	BA2133
FDB700	BA2081	FDB954	BA2028	FDS393	BA2055
FDB701	BA2080	FDB956	BA2280	FDS406	BA2050
FDB707	BA2227	FDB96	BA2041	FDS434	BA2036
FDB708	BA2111	FDB967	BA2045	FDS541	BA2017
FDB715	BA2115	FDB968	BA2046	FDS541	BA2032
FDB719	BA2074	FDB969	BA2333	FDS558	BA2076
FDB720	BA2048	FDB970	BA2049	FDS578	BA2054
FDB722	BA2322	FDB973	BA2095	FDS584	BA2137
FDB725	BA2108	FDB979	BA2094	FDS586	BA2098
FDB729	BA2066	FDB984	BA2118	FDS610	BA2039
FDB729	BA2083	FDB997	BA2166	FDS613	BA2010
FDB730	BA2066	FDB999	BA2048	FDS617	BA2084
FDB732	BA2136	FDS1040	BA2142	FDS725	BA2108
FDB745	BA2097	FDS1049	BA2150	FDS729	BA2066
FDB749	BA2071	FDS1050	BA2168	FDS729	BA2083
FDB752	BA2068	FDS1056	BA2143	FDS732	BA2136
FDB763	BA2113	FDS1063	BA2016	FDS745	BA2097
FDB764	BA2117	FDS1067	BA2137	FDS749	BA2071
FDB765	BA2249	FDS1068	BA2207	FDS765	BA2249
FDB766	BA2138	FDS1072	BA2141	FDS766	BA2138
FDB767	BA2138	FDS1073	BA2169	FDS767	BA2138
FDB774	BA2037	FDS1081	BA2144	FDS774	BA2037
FDB774C	BA2037	FDS1082	BA2146	FDS775	BA2031
FDB774D	BA2037	FDS1083	BA2017	FDS775	BA2038
FDB775	BA2038	FDS1083	BA2032	FDS777	BA2274
FDB775C	BA2038	FDS1101	BA2152	FDS779	BA2125
FDB775D	BA2038	FDS1112	BA2021	FDS845	BA2023
FDB777	BA2274	FDS1113	BA2035	FDS850	BA2053
FDB779	BA2125	FDS1160	BA2332	FDS857	BA2167
FDB799	BA2163	FDS1288	BA2153	FDS867	BA2116
FDB800	BA2174	FDS1289	BA2160	FDS876	BA2140
FDB805	BA2019	FDS1293	BA2173	FDS876	BA2151
FDB817	BA2019	FDS1294	BA2197	FDS925	BA2073
FDB845	BA2023	FDS1295	BA2211	FDS96	BA2041
FDB845B	BA2023	FDS1300	BA2108	FHW004	BAW1401
FDB845F	BA2023	FDS1301	BA2053	FHW005	BAW1501
FDB850	BA2053	FDS1312	BA2018	FHW010	BAW1701
FDB853	BA2028	FDS1318	BA2209	FHW021	BAW1705
FDB854	BA2044	FDS1323	BA2172	FHW027	BAW1901
FDB857	BA2167	FDS1349	BA2271	FHW030	BAW1905
FDB859	BA2232	FDS1378	BA2089	FHW038	BAW1902
FDB867	BA2116	FDS1398	BA2155	FHW041	BAW1904
FDB874	BA2078	FDS1399	BA2214	FHW043	BAW1909
FDB876	BA2140	FDS1463	BA2205	FHW044	BAW1910
FDB877	BA2076	FDS1467	BA2299	FHW045	BAW1913

# Vergleichsliste

Liste des correspondances / Tabella di conversione codici / Lista de comparação /



Lista porównawcza numerów / Porovnávací seznam čísel

FERODO		FERODO		FERODO	
FHW046	BAW1912	FHW429	BAW1701	FQT1318	BA2209
FHW047	BAW1909	FHY2000	BAH0011	FQT1319	BA2208
FHW048	BAW1910	FHY2011	BAH0004	FQT1323	BA2172
FHW059	BAW2004	FHY2024	BAH0009	FQT1349	BA2271
FHW084	BAW2005	FHY2032	BAH0030	FQT1378	BA2089
FHW085	BAW2006	FHY2033	BAH0003	FQT1394	BA2199
FHW088	BAW2006	FHY2054	BAH0015	FQT1398	BA2155
FHW090	BAW2005	FHY2055	BAH0008	FQT1399	BA2214
FHW093	BAW2007	FHY2064	BAH0024	FQT1416	BA2225
FHW135	BAW2201	FHY2076	BAH0010	FQT1420	BA2219
FHW149	BAW2501	FHY2088	BAH0012	FQT1424	BA2210
FHW193	BAW2301	FHY2089	BAH0005	FQT1425	BA2224
FHW194	BAW2203	FHY2113	BAH0029	FQT1428	BA2177
FHW209	BAW2003	FHY2116	BAH0031	FQT1429	BA2177
FHW210	BAW2009	FHY2138	BAH0004	FQT1467	BA2299
FHW214	BAW1906	FHY2162	BAH0016	FQT1469	BA2303
FHW217	BAW2010	FHY2206	BAH0027	FQT1476	BA2229
FHW218	BAW2500	FHY2208	BAH0033	FQT1476	BA2289
FHW222	BAW2001	FHY2223	BAH0023	FQT1481	BA2228
FHW224	BAW1902	FHY2240	BAH0031	FQT1491	BA2212
FHW227	BAW2008	FHY2253	BAH0001	FQT1496	BA2269
FHW233	BAW2600	FHY2256	BAH0025	FQT1521	BA2194
FHW235	BAW2800	FHY2285	BAH0007	FQT1556	BA2285
FHW301	BAW2008	FHY2297	BAH0006	FQT1594	BA2234
FHW303	BAW2008	FHY2299	BAH0028	FQT1635	BA2155
FHW321	BAW2202	FHY2300	BAH0018	FQT1640	BA2255
FHW322	BAW1907	FHY2301	BAH0006	FQT1717	BA2172
FHW323	BAW2207	FHY2305	BAH0020	FQT1788	BA2017
FHW333	BAW2205	FHY2318	BAH0026	FQT1931	BA2258
FHW335	BAW2007	FHY2446	BAH0019	FQT393	BA2023
FHW336	BAW1901	FHY2468	BAH0017	FQT393	BA2055
FHW337	BAW1702	FQT1000	BA2047	FQT406	BA2050
FHW338	BAW2201	FQT1002	BA2079	FQT558	BA2076
FHW339	BAW1905	FQT1040	BA2142	FQT613	BA2010
FHW346	BAW2006	FQT1056	BA2143	FQT619	BA2099
FHW347	BAW2005	FQT1063	BA2016	FQT719	BA2074
FHW354	BAW1706	FQT1068	BA2207	FQT725	BA2108
FHW4003	BAW2002	FQT1073	BA2169	FQT729	BA2066
FHW4004	BAW2004	FQT1075	BA2170	FQT729	BA2083
FHW4018	BAW1704	FQT1082	BA2146	FQT732	BA2136
FHW4023	BAW1903	FQT1083	BA2017	FQT774	BA2037
FHW4025	BAW2501	FQT1083	BA2032	FQT775	BA2031
FHW4033	BAW1501	FQT1094	BA2154	FQT775	BA2038
FHW4038	BAW1914	FQT1101	BA2152	FQT845	BA2023
FHW404	BAW1707	FQT1112	BA2021	FQT850	BA2053
FHW4042	BAW2500	FQT1113	BA2035	FQT867	BA2116
FHW4045	BAW1911	FQT1117	BA2095	FQT874	BA2078
FHW405	BAW1703	FQT1135	BA2090	FQT876	BA2140
FHW4052	BAW1911	FQT1168	BA2151	FQT876	BA2151
FHW4098	BAW2002	FQT1288	BA2153	FQT884	BA2139
FHW4099	BAW1401	FQT1293	BA2173	FQT925	BA2073
FHW4108	BAW2600	FQT1294	BA2197	FSB188	BAE5020
FHW4158	BAW2009	FQT1295	BA2211	FSB191	BAE5003
FHW418	BAW1914	FQT1299	BA2315	FSB208	BAE5035
FHW425	BAW1908	FQT1300	BA2108	FSB232	BAE5014
FHW4289	BAW1705	FQT1301	BA2053	FSB241	BAE5035

# Vergleichsliste

Liste des correspondances / Tabella di conversione codici / Lista de comparação /



Lista porównawcza numerów / Porovnávací seznam čísel

FERODO		FERODO		FERODO	
FSB243	BAE5008	FSL1067	BA2137	FSL1461	BA2262
FSB265	BAE5021	FSL1068	BA2207	FSL1463	BA2205
FSB273	BAE5006	FSL1072	BA2141	FSL1476	BA2229
FSB332	BAE5034	FSL1073	BA2169	FSL1476	BA2289
FSB334	BAE5005	FSL1075	BA2170	FSL1478	BA2241
FSB335	BAE5011	FSL1081	BA2144	FSL1479	BA2324
FSB408	BAE5001	FSL1082	BA2146	FSL1480	BA2323
FSB409	BAE5006	FSL1083	BA2017	FSL1518	BA2201
FSB421	BAE5031	FSL1093	BA2268	FSL1519	BA2321
FSB422	BAE5030	FSL1094	BA2154	FSL1520	BA2236
FSB428	BAE5024	FSL1095	BA2226	FSL1521	BA2194
FSB428R	BAE5024	FSL1096	BA2273	FSL1544	BA2230
FSB447	BAE5013	FSL1101	BA2152	FSL1573	BA2270
FSB477	BAE5016	FSL1112	BA2021	FSL1580	BA2278
FSB478	BAE5013	FSL1113	BA2035	FSL1635	BA2155
FSB513	BAE5042	FSL1117	BA2095	FSL1636	BA2196
FSB513R	BAE5042	FSL1124	BA2022	FSL1641	BA2195
FSB519	BAE5002	FSL1131	BA2322	FSL1654	BA2231
FSB534	BAE5023	FSL1132	BA2202	FSL1766	BA2235
FSB534R	BAE5023	FSL1135	BA2090	FSL1781	BA2023
FSB535	BAE5037	FSL114	BA2082	FSL1807	BA2309
FSB537	BAE5030	FSL1160	BA2332	FSL1876	BA2215
FSB540	BAE5027	FSL1163	BA2171	FSL1885	BA2287
FSB543	BAE5004	FSL1167	BA2148	FSL1923	BA2275
FSB544	BAE5022	FSL1168	BA2151	FSL1924	BA2275
FSB545	BAE5012	FSL1276	BA2084	FSL1927	BA2265
FSB549	BAE5009	FSL1288	BA2153	FSL1928	BA2306
FSB552	BAE5015	FSL1289	BA2160	FSL1929	BA2305
FSB555	BAE5038	FSL1293	BA2173	FSL1930	BA2304
FSB565	BAE5041	FSL1294	BA2197	FSL2	BA2162
FSB565R	BAE5041	FSL1295	BA2211	FSL206	BA2144
FSB567	BAE5019	FSL1300	BA2108	FSL212	BA2144
FSB569	BAE5007	FSL1301	BA2053	FSL222	BA2052
FSB569R	BAE5007	FSL1303	BA2176	FSL275	BA2039
FSB571	BAE5029	FSL1312	BA2018	FSL287	BA2024
FSB571R	BAE5029	FSL1318	BA2209	FSL29	BA2062
FSB583	BAE5017	FSL1319	BA2208	FSL296	BA2189
FSB590R	BAE5028	FSL1323	BA2172	FSL308	BA2121
FSB596R	BAE5018	FSL1337	BA2123	FSL346	BA2065
FSB603	BAE5010	FSL1378	BA2089	FSL370	BA2034
FSB635	BAE5036	FSL1382	BA2253	FSL385	BA2131
FSB636	BAE5039	FSL1384	BA2237	FSL392	BA2133
FSL1000	BA2047	FSL1393	BA2203	FSL398	BA2030
FSL1002	BA2079	FSL1394	BA2199	FSL4035	BA2335
FSL1024	BA2181	FSL1396	BA2325	FSL406	BA2050
FSL1038	BA2149	FSL1398	BA2155	FSL414	BA2086
FSL1039	BA2233	FSL1399	BA2214	FSL419	BA2132
FSL1040	BA2142	FSL1416	BA2225	FSL428	BA2056
FSL1043	BA2239	FSL1420	BA2219	FSL434	BA2020
FSL1044	BA2250	FSL1423	BA2260	FSL434	BA2036
FSL1045	BA2215	FSL1424	BA2210	FSL435	BA2111
FSL1054	BA2145	FSL1425	BA2224	FSL440	BA2077
FSL1055	BA2147	FSL1439	BA2278	FSL455	BA2036
FSL1056	BA2143	FSL1451	BA2198	FSL517	BA2025
FSL1062	BA2015	FSL1452	BA2251	FSL520	BA2187
FSL1063	BA2016	FSL1453	BA2261	FSL524	BA2033

# Vergleichsliste

Liste des correspondances / Tabella di conversione codici / Lista de comparação /



Lista porównawcza numerów / Porovnávací seznam čísel

FERODO		FERODO		FERODO	
FSL525	BA2095	FSL876	BA2151	FVR1930	BA2304
FSL527	BA2040	FSL878	BA2107	FVR239	BA2101
FSL534	BA2060	FSL880	BA2013	FVR287	BA2024
FSL535	BA2096	FSL881	BA2075	FVR414	BA2086
FSL535	BA2097	FSL884	BA2139	FVR501	BA2124
FSL540	BA2043	FSL909	BA2119	FVR517	BA2025
FSL541	BA2017	FSL925	BA2073	FVR700	BA2081
FSL541	BA2032	FSL950	BA2118	FVR701	BA2080
FSL556	BA2112	FSL954	BA2028	FVR722	BA2322
FSL558	BA2076	FSL954	BA2031	FVR805	BA2019
FSL576	BA2110	FSL956	BA2280	FVR941	BA2068
FSL578	BA2054	FSL96	BA2041	FVR967	BA2045
FSL584	BA2137	FSL967	BA2045	FVR968	BA2046
FSL586	BA2098	FSL968	BA2046	FVR970	BA2049
FSL589	BA2146	FSL969	BA2333	FWI201	BAV1007
FSL590	BA2135	FSL970	BA2049	FWI202	BAV1003
FSL608	BA2012	FSL973	BA2095	FWI203	BAV1035
FSL610	BA2039	FVR1000	BA2047	FWI204	BAV1002
FSL613	BA2010	FVR1002	BA2079	FWI205	BAV1006
FSL615	BA2106	FVR1038	BA2149	FWI206	BAV1004
FSL617	BA2084	FVR1043	BA2239	FWI207	BAV1001
FSL619	BA2099	FVR1045	BA2215	FWI209	BAV1028
FSL660	BA2026	FVR1131	BA2322	FWI210	BAV1029
FSL678	BA2114	FVR1132	BA2202	FWI211	BAV1027
FSL686	BA2175	FVR1163	BA2171	FWI213	BAV1003
FSL700	BA2081	FVR1292	BA2320	FWI226	BAV1004
FSL701	BA2080	FVR1304	BA2091	FWI227	BAV1004
FSL715	BA2115	FVR1306	BA2216	FWI228	BAV1035
FSL719	BA2074	FVR1338	BA2081	FWI232	BAV1005
FSL720	BA2048	FVR1339	BA2080	FWI233	BAV1007
FSL722	BA2322	FVR1396	BA2325	FWI236	BAV1003
FSL725	BA2108	FVR1452	BA2251	FWI239	BAV1031
FSL729	BA2066	FVR1453	BA2261	FWI241	BAV1036
FSL729	BA2083	FVR1461	BA2262	FWI243	BAV1017
FSL730	BA2066	FVR1478	BA2241	FWI246	BAV1008
FSL732	BA2136	FVR1479	BA2324	FWI248	BAV1032
FSL745	BA2097	FVR1480	BA2323	FWI250	BAV1016
FSL749	BA2071	FVR1493	BA2263	FWI251	BAV1030
FSL763	BA2113	FVR1494	BA2264	FWI252	BAV1009
FSL764	BA2117	FVR1515	BA2254	FWI253	BAV1010
FSL765	BA2249	FVR1516	BA2247	FWI254	BAV1011
FSL766	BA2138	FVR1518	BA2201	FWI259	BAV1013
FSL767	BA2138	FVR1519	BA2321	FWI260	BAV1015
FSL774	BA2037	FVR1642	BA2242	FWI261	BAV1046
FSL775	BA2031	FVR1643	BA2242	FWI263	BAV1025
FSL775	BA2038	FVR1644	BA2243	FWI264	BAV1018
FSL777	BA2274	FVR1647	BA2327	FWI265	BAV1019
FSL779	BA2125	FVR1778	BA2281	FWI266	BAV1023
FSL799	BA2163	FVR1780	BA2277	FWI267	BAV1024
FSL805	BA2019	FVR1876	BA2215	FWI268	BAV1043
FSL845	BA2023	FVR1879	BA2239	FWI270	BAV1038
FSL850	BA2053	FVR1923	BA2275	FWI271	BAV1039
FSL859	BA2232	FVR1924	BA2275	FWI272	BAV1020
FSL867	BA2116	FVR1927	BA2265	FWI273	BAV1052
FSL874	BA2078	FVR1928	BA2306	FWI274	BAV1053
FSL876	BA2140	FVR1929	BA2305	FWI275	BAV1037

# Vergleichsliste

Liste des correspondances / Tabella di conversione codici / Lista de comparação /



Lista porównawcza numerów / Porovnávací seznam čísel

FERODO		FERODO		FERODO	
FWI276	BAV1022	TAR1378	BA2089	TAR541	BA2032
FWI277	BAV1040	TAR1384	BA2237	TAR556	BA2112
FWI278	BAV1026	TAR1393	BA2203	TAR558	BA2076
FWI291	BAV1041	TAR1394	BA2199	TAR576	BA2110
TAR1000	BA2047	TAR1396	BA2325	TAR578	BA2054
TAR1002	BA2079	TAR1398	BA2155	TAR584	BA2137
TAR1024	BA2181	TAR1399	BA2214	TAR586	BA2098
TAR1038	BA2149	TAR1416	BA2225	TAR589	BA2146
TAR1039	BA2233	TAR1420	BA2219	TAR590	BA2135
TAR1040	BA2142	TAR1423	BA2260	TAR608	BA2012
TAR1044	BA2250	TAR1424	BA2210	TAR613	BA2010
TAR1045	BA2215	TAR1425	BA2224	TAR615	BA2106
TAR1054	BA2145	TAR1439	BA2278	TAR617	BA2084
TAR1055	BA2147	TAR1451	BA2198	TAR619	BA2099
TAR1056	BA2143	TAR1461	BA2262	TAR660	BA2026
TAR1062	BA2015	TAR1463	BA2205	TAR669	BA2027
TAR1063	BA2016	TAR1520	BA2236	TAR678	BA2114
TAR1067	BA2137	TAR163	BA2193	TAR686	BA2175
TAR1068	BA2207	TAR173	BA2134	TAR700	BA2081
TAR1072	BA2141	TAR192	BA2185	TAR701	BA2080
TAR1081	BA2144	TAR2	BA2162	TAR708	BA2111
TAR1082	BA2146	TAR206	BA2144	TAR715	BA2115
TAR1083	BA2017	TAR256	BA2188	TAR719	BA2074
TAR1083	BA2032	TAR275	BA2039	TAR720	BA2048
TAR1093	BA2268	TAR287	BA2024	TAR722	BA2322
TAR1094	BA2154	TAR29	BA2062	TAR725	BA2108
TAR1095	BA2226	TAR296	BA2189	TAR729	BA2066
TAR1096	BA2273	TAR308	BA2121	TAR729	BA2083
TAR1101	BA2152	TAR328	BA2093	TAR730	BA2066
TAR1112	BA2021	TAR346	BA2065	TAR732	BA2136
TAR1113	BA2035	TAR370	BA2034	TAR745	BA2097
TAR1116	BA2122	TAR385	BA2131	TAR749	BA2071
TAR1117	BA2095	TAR392	BA2133	TAR763	BA2113
TAR1124	BA2022	TAR393	BA2055	TAR764	BA2117
TAR1131	BA2322	TAR398	BA2030	TAR765	BA2249
TAR1132	BA2202	TAR406	BA2050	TAR766	BA2138
TAR1135	BA2090	TAR414	BA2086	TAR767	BA2138
TAR114	BA2082	TAR415	BA2029	TAR774	BA2037
TAR1160	BA2332	TAR419	BA2131	TAR775	BA2031
TAR1163	BA2171	TAR419	BA2132	TAR775	BA2038
TAR1167	BA2148	TAR428	BA2056	TAR777	BA2274
TAR1168	BA2151	TAR434	BA2020	TAR779	BA2125
TAR1276	BA2084	TAR434	BA2036	TAR799	BA2163
TAR1288	BA2153	TAR435	BA2111	TAR805	BA2019
TAR1289	BA2160	TAR440	BA2077	TAR845	BA2023
TAR1293	BA2173	TAR455	BA2036	TAR850	BA2053
TAR1294	BA2197	TAR517	BA2025	TAR853	BA2028
TAR1295	BA2211	TAR520	BA2187	TAR854	BA2044
TAR1300	BA2108	TAR524	BA2033	TAR859	BA2232
TAR1301	BA2053	TAR525	BA2095	TAR867	BA2116
TAR1303	BA2176	TAR527	BA2040	TAR874	BA2078
TAR1312	BA2018	TAR534	BA2060	TAR876	BA2140
TAR1318	BA2209	TAR535	BA2096	TAR876	BA2151
TAR1319	BA2208	TAR535	BA2097	TAR878	BA2107
TAR1323	BA2172	TAR540	BA2043	TAR880	BA2013
TAR1337	BA2123	TAR541	BA2017	TAR881	BA2075

# Vergleichsliste

Liste des correspondances / Tabella di conversione codici / Lista de comparação /

Lista porównawcza numerów / Porovnávací seznam čísel



FERODO		FIAT		FIAT	
TAR884	BA2139	55700398	BAR12184	7531819	BAR16105
TAR909	BA2119	55700918	BAR12184	7568440	BAR16105
TAR925	BA2073	5888149	BA2062	7645056	BAR20142
TAR950	BA2118	5888154	BA2062	7663465	BAR11119
TAR954	BA2028	5888781	BA2033	7663466	BAR12127
TAR954	BA2031	5889089	BA2034	7685656	BAR11119
TAR956	BA2280	5892310	BA2065	7696710	BAW1902
TAR96	BA2041	5892330	BA2033	7734997	BAW2009
TAR967	BA2045	5892481	BA2034	77362092	BA2299
TAR968	BA2046	5892727	BA2034	77362185	BA2072
TAR969	BA2333	5892728	BA2034	77362186	BA2143
TAR970	BA2049	5892730	BA2034	77362190	BA2332
TAR973	BA2095	5892732	BA2034	77362193	BA2315
TAR979	BA2094	5892733	BA2034	77362195	BA2299
		5892734	BA2034	77362199	BA2142
<b>FIAT</b>		5892735	BA2034	77362205	BA2334
		5892736	BA2073	77362209	BA2046
1300500080	BAR18108	5892737	BA2072	77362212	BA2045
1300501080	BAR24127	5892786	BA2071	77362216	BA2324
1307356080	BAR24138	5951660	BA2064	77362219	BA2241
1309392080	BAR26104	5951671	BA2065	77362229	BA2315
1316323080	BAR20155	5951897	BA2062	77362231	BA2315
1317651080	BAR26104	60501338	BAH0004	77362235	BA2325
1325772080	BAR28136	60501727	BAH0004	77362236	BA2285
4434816	BA2062	60709427	BAH0004	77362237	BA2047
46401356	BAR22197	60709762	BAH0004	77362238	BA2079
46403088	BAR22147	60718544	BAH0004	77362267	BA2072
46403959	BAR22147	60777600	BA2034	77362271	BA2303
46403960	BAR11119	60777601	BA2035	77362274	BA2323
46416712	BAR20142	60806135	BAR22147	77362275	BA2271
46423415	BAR20142	60806137	BAR20142	77362276	BA2271
46448168	BAR22147	60808872	BAR12127	77362284	BAE5029
46455892	BAR22147	60809894	BAR16105	77362285	BAE5038
46542383	BAR22197	60809966	BAW2008	77362286	BAE5032
46758714	BAR22147	60810076	BAR20142	77362296	BAE5010
46806233	BAR24127	60810239	BA2034	77362297	BAE5016
46806234	BAR24138	60810404	BAR22147	77362428	BAE5042
46820655	BAR12127	60811256	BAR20142	77362429	BAE5023
46831041	BAR22197	60811266	BAR20142	77362451	BAE5037
46836489	BAR12157	60811879	BAR11119	77362479	BA2072
46836491	BAR25141	60812422	BAR22147	77362610	BAW2009
46844071	BAR25141	60813038	BAR22147	77362675	BA2271
51728378	BAR24138	71711135	BA2079	77362743	BA2289
51740244	BAR24127	71737178	BA2073	77362768	BA2303
51740247	BAR24138	71737179	BA2072	77363341	BA2271
51749124	BAR20142	71737950	BAW2008	77363496	BA2334
51806099	BAR12184	71737951	BAW2008	77363604	BA2236
51806103	BAR12184	71738324	BAW1902	77363942	BA2283
51819733	BAR25141	71738378	BAE5016	77363956	BA2285
51848619	BAR24127	71739132	BAW2501	77363974	BA2283
51858363	BAR24138	71739597	BAE5010	77364014	BA2275
51859075	BAR12127	71752978	BA2324	77364015	BA2328
51866265	BAR12127	71752979	BA2241	77364016	BA2265
51876438	BAR11119	71752980	BA2045	77364160	BA2275
51896287	BAR22197	71753042	BA2143	77364224	BA2236
51896288	BAR22197	71769481	BAR11119	77364281	BA2289



# Vergleichsliste

Liste des correspondances / Tabella di conversione codici / Lista de comparação /



Lista porównawcza numerów / Porovnávací seznam čísel

FIAT		FIAT		FORD	
77364318	BA2328	9945788	BA2045	1001093	BAR25114
77364393	BA2283	9945810	BA2046	1001094	BAR10223
77364394	BA2283	9945821	BA2035	1001095	BA2147
77364447	BA2285	9945822	BA2035	1001096	BA2017
77364477	BA2283	9945823	BA2035	1001348	BAH0007
77364511	BA2329	9945884	BAE5042	1005960	BAE5004
77364512	BA2329	9945885	BAE5023	1005968	BAE5015
77364513	BA2330	9945891	BAW2600	1005970	BAE5004
77364567	BA2271	9945895	BAW2800	1006011	BAW2007
77364599	BA2299	9945911	BAW2501	1006012	BAW2201
77364635	BA2302	9945975	BAE5016	1006013	BAW1702
77364637	BA2283	9945980	BAW2003	1006016	BAW1901
77364839	BA2271	9946016	BA2047	1010502	BA2146
77364859	BA2324	9947007	BA2035	1010503	BA2144
77364897	BA2289	9947118	BA2142	1013581	BAR12141
7757604	BAW2008	9947124	BA2143	1013815	BAH0032
7779409	BAR20142	9947468	BA2072	1013843	BA2146
790605	BA2062	9947629	BA2142	1014204	BAH0029
790833	BAW1902	9947630	BA2143	1014316	BAE5034
791906	BA2064	9947690	BAE5038	1014655	BAE5031
792539	BA2064	9947773	BAE5016	1019598	BAR12141
792561	BA2065	9947934	BA2332	1019604	BAR20147
792589	BA2064	9947939	BAE5029	1022079	BA2138
792725	BA2065	9947943	BAW2008	1023605	BAR10223
793120	BA2033	9947976	BA2072	1027640	BA2017
793184	BA2034	9948045	BA2072	1027703	BA2147
793322	BA2065	9948054	BA2072	1030601	BA2146
793323	BA2065	9948232	BAW1902	1031781	BA2084
793325	BA2064	9948338	BA2271	1031843	BA2147
793460	BA2034	9948373	BAE5010	1041906	BAE5015
794079	BA2033	9948476	BA2315	1042688	BA2144
794091	BA2034	9948626	BA2325	1045994	BAR25114
794858	BA2034	9948845	BA2315	1045995	BAR10223
794870	BA2033	9948870	BA2334	1048308	BA2084
795915	BA2079	9949048	BA2143	1048309	BA2084
82450657	BAR22147	9949183	BA2072	1059500	BAE5004
92498609	BAR12127	9949276	BA2299	1060096	BAE5015
93500520	BAR16105	9949280	BA2303	1064762	BA2146
9404251518	BA2079	9949332	BA2271	1064763	BA2144
9404252328	BA2017	9949362	BA2324	1065033	BAE5015
9467548887	BA2329	9949407	BA2323	1066271	BAR20147
9467548987	BA2329	9949408	BA2323	1073731	BA2139
9467549087	BA2330	9949459	BAW2600	1073732	BA2138
9467549388	BAE5042	9949482	BA2241	1075549	BAE5041
9566949580	BAE5037	9949490	BAE5032	1075558	BA2209
9566949780	BAW1906	9949516	BA2241	1075565	BA2208
9569692680	BAE5037	9949517	BA2324	1079347	BA2139
9938868	BAW2501	9949552	BA2285	1079348	BA2138
9940092	BA2024	9950479	BA2035	1079919	BA2146
9940554	BAW2501	9950713	BA2035	1079920	BA2144
9941207	BA2024	9950714	BA2035	1088934	BA2276
9941669	BA2035	9950853	BA2035	1088938	BA2286
9942904	BA2035	9951217	BA2315	1095201	BA2139
9945070	BA2024	9951222	BA2271	1095202	BA2138
9945379	BAW1902			1096940	BA2138
9945496	BA2035			1096942	BA2139

# Vergleichsliste

Liste des correspondances / Tabella di conversione codici / Lista de comparação /



Lista porównawcza numerów / Porovnávací seznam čísel

FORD		FORD		FORD	
1101462	BA2199	1204852	BA2286	1433958	BA2304
1101464	BA2199	1205696	BA2318	1436498	BA2314
1104128	BAE5004	1206062	BA2203	1437761	BA2314
1104131	BAW1702	1207104	BA2225	1439867	BA2313
1104132	BAW1901	1207519	BA2228	1458247	BA2314
1106077	BAW1914	1219892	BA2225	1459408	BA2313
1106633	BAE5036	1219894	BA2225	1465126	BA2146
1107697	BA2209	1223664	BAR25162	1465168	BA2262
1107698	BA2208	1223666	BAR25162	1469083	BAR25162
1109024	BAH0027	1223682	BA2234	1473006	BAR10115
1111857	BA2203	1227045	BAE5018	1473056	BAE5031
1111858	BA2203	1227046	BAE5028	1473067	BAE5015
1112542	BAR12141	1227108	BA2225	1473068	BAE5004
1113980	BAW2201	1233679	BA2258	1477803	BA2313
1115107	BA2017	1236880	BA2199	1484750	BAW1901
1115986	BAW2203	1236882	BAE5036	1484751	BAW2007
1121359	BAH0027	1250688	BA2224	1484752	BAW1702
1121894	BA2224	1253964	BAR25162	1486316	BAW1901
1121895	BA2225	1253965	BAR25162	1486750	BAW1901
1123789	BAE5039	1304007	BAH0027	1500152	BAR25162
1123790	BAE5036	1318147	BA2262	1500668	BA2286
1125669	BAE5036	1320581	BAR20147	1508074	BA2234
1126158	BAE5041	1320582	BAR20147	1514237	BAR10115
1126532	BAW2007	1320585	BAR22172	1517558	BAW1702
1126718	BA2224	1321488	BAR24161	1517559	BAW1901
1128463	BA2199	1321517	BA2234	1519528	BA2234
1129985	BA2276	1323102	BAR12154	1520297	BAR25162
1129986	BA2286	1323560	BAR25162	1521329	BA2287
1130120	BA2225	1323620	BAR22172	1522073	BA2287
1130715	BA2203	1323621	BAR10115	1530602	BA2304
1130751	BA2084	1324300	BA2258	1541804	BAR11119
1130758	BA2138	1343514	BA2017	1553797	BA2306
1133442	BAW2201	1345337	BA2228	1554523	BA2305
1133445	BA2269	1345340	BA2017	1554524	BA2304
1133446	BA2318	1356392	BA2287	1554724	BAW2009
1133447	BA2228	1360254	BA2258	1559698	BA2302
1133448	BA2200	1360304	BA2235	1560014	BA2306
1133750	BA2084	1360305	BA2234	1560023	BA2305
1134158	BA2081	1360306	BA2258	1560026	BA2304
1134159	BA2080	1371402	BA2306	1566096	BA2258
1135083	BAE5036	1371403	BA2305	1566234	BA2313
1136519	BA2209	1371454	BA2304	1595523	BA2144
1140278	BAR13194	1373370	BAR25162	1595875	BAR24112
1141782	BAR26115	1373781	BAR10115	1619053	BAR24112
1144288	BA2262	1376118	BAR24161	1619054	BAR24112
1145292	BAE5036	1376138	BAR12154	1619209	BA2144
1145295	BAW1914	1379971	BA2314	1619229	BAR24112
1145299	BA2199	1386603	BA2200	1629474	BAR24112
1148202	BAR22172	1417551	BAE5036	1629476	BAR24112
1151049	BA2209	1425406	BA2209	1629482	BAR24112
1151377	BA2231	1425407	BA2208	1629483	BAR24112
1152316	BA2225	1427386	BA2314	1630149	BAR10115
1197674	BAE5036	1432363	BA2314	1637969	BAR10115
1204843	BA2224	1433865	BAE5039	1638880	BA2030
1204845	BA2225	1433952	BA2306	1644844	BAR24112
1204850	BA2276	1433954	BA2305	1644845	BAR24112

# Vergleichsliste

Liste des correspondances / Tabella di conversione codici / Lista de comparação /



Lista porównawcza numerów / Porovnávací seznam čísel

FORD		FORD		FORD	
1648236	BA2030	5022654	BAR20147	6191062	BAR10196
1652206	BA2030	5022659	BAR24112	6191063	BAR10196
1659938	BA2146	5022660	BAR24112	6191064	BAR20147
1682005	BA2313	5022666	BAR10115	6191842	BAH0032
1683374	BA2258	5022948	BAR24112	6196051	BAW2007
1695810	BA2234	5023483	BAR10115	6196052	BAW1901
1712024	BA2234	5023573	BAR24112	6196053	BAW2201
1721086	BA2305	5023994	BA2144	6197738	BA2081
1747043	BA2314	5025048	BA2146	6197739	BA2080
1954433	BAR26109	5025610	BAR24131	6203650	BA2146
1954460	BA2119	5025611	BAR24132	6464705	BAW2010
1956495	BA2119	5025929	BA2146	6464706	BAW2500
1957042	BA2119	5026661	BA2084	6500952	BA2084
1M21-2K021-AA	BA2231	5026784	BAR24120	6500954	BA2084
2T14-2M008-AA	BA2238	5027604	BA2084	6511773	BA2144
3395510	BAR24129	5028281	BAR20147	6569119	BAH0032
3401278	BA2118	5028763	BA2081	6669779	BA2276
3555344	BAR22172	5028764	BA2080	6669780	BA2286
3573537	BAR22172	5029147	BA2139	6704268	BA2144
3894048	BA2118	5029148	BA2138	6704271	BA2084
3958455	BAR24129	5029815	BAR24131	6710016	BAE5030
3M51-2K021-AA	BA2234	5029816	BAR24132	6710017	BAE5030
3M51-2K021-AB	BA2234	5030658	BAR10115	6808557	BAW2203
3M51-2M008-AA	BA2258	5M21-2M008-BB	BA2200	6827588	BA2139
3M51-2M008-AB	BA2258	6009659	BAW2007	6877836	BA2139
3M51-2M008-AC	BA2258	6077974	BAR24112	6877837	BA2138
4055724	BAE5028	6088234	BAW2201	6882584	BA2139
4055730	BAW2500	6095773	BA2144	6978969	BAE5021
4056029	BAR24120	6121697	BA2144	6C11-2K021-AE	BA2306
4070865	BAR24120	6127520	BA2144	6C11-2K021-BE	BA2305
4071714	BAR20147	6130483	BA2144	6C11-2M008-AE	BA2304
4077455	BAR22172	6132807	BA2144	6G91-2K021-A2D	BA2314
4083484	BAR10115	6133549	BAR24112	6G91-2M008-GC	BA2313
4084226	BAR20147	6133550	BAR24112	6G91-2M008-GD	BA2313
4095038	BAE5018	6134507	BAR24112	7018202	BA2081
4095132	BA2262	6136893	BA2144	7018203	BA2080
4097477	BAR24161	6141150	BA2030	7055297	BAE5030
4097478	BAR24161	6144685	BA2144	7117257	BAW1903
4098427	BAR12154	6147496	BA2144	7125122	BAE5034
4098428	BAR12154	6158202	BAR24112	7153476	BA2276
4110585	BAE5018	6158204	BAR24112	7153477	BA2286
4114749	BA2262	6158210	BAR24112	7166588	BAE5021
4143208	BAE5028	6158211	BAR24112	7176735	BAE5031
4176921	BAR12154	6158945	BA2144	7204066	BAR10115
4179398	BAR24161	6162190	BA2146	7267808	BAE5030
4179406	BAR12154	6162338	BA2030	7335771	BAH0007
4181042	BAR24161	6166952	BA2144	89BB-2K021-AB	BA2144
4387371	BA2238	6174117	BA2144	93BB-2K021-EB	BA2139
4455986	BAE5028	6178479	BA2144	93BB-2K021-FB	BA2138
4525732	BAE5028	6178480	BA2144	93GB-2K021-CA	BA2139
4540771	BAE5018	6179304	BAH0030	93GB-2K021-CB	BA2139
4743576	BAE5028	6180371	BA2084	95VW-2078-AE	BAH0007
5015919	BA2144	6183876	BAE5021	96FB-2282-AC	BAH0029
5018899	BA2144	6188427	BA2146	97BG-2K021-AA	BA2138
5022652	BAR10196	6189145	BA2144	97BG-2K021-AB	BA2138
5022653	BAR10196	6189146	BA2144	97BG-2K021-BA	BA2139

# Vergleichsliste

Liste des correspondances / Tabella di conversione codici / Lista de comparação /



Lista porównawcza numerów / Porovnávací seznam čísel

FORD		FTE automotive		FTE automotive	
97BG-2K021-BB	<b>BA2139</b>	435.632E.2	<b>BAH0005</b>	BL1035B3	<b>BA2038</b>
98AB-2K021-AD	<b>BA2209</b>	435E.825E.1	<b>BAH0023</b>	BL1037A2	<b>BA2053</b>
9C11-2K021-BA	<b>BA2305</b>	450.449E.1	<b>BAH0007</b>	BL1043A2	<b>BA2013</b>
9S51-1125-CA	<b>BAR11119</b>	455E.660E.1	<b>BAH0027</b>	BL1058A1	<b>BA2082</b>
9S51-2261-AA	<b>BAW2009</b>	480.629E.1	<b>BAH0028</b>	BL1058F2	<b>BA2082</b>
9S51-2K021-BA	<b>BA2302</b>	BB1017A1	<b>BAE5003</b>	BL1070A2	<b>BA2109</b>
AV61-2K021-BA	<b>BA2234</b>	BB1036A2	<b>BAE5020</b>	BL1073A1	<b>BA2107</b>
AV61-2K021-BB	<b>BA2234</b>	BB1049A2	<b>BAE5033</b>	BL1077A2	<b>BA2193</b>
AV61-2M008-AA	<b>BA2258</b>	BB1059A1	<b>BAE5035</b>	BL1099A1	<b>BA2126</b>
BG91-2K021-AA	<b>BA2314</b>	BB1099A2	<b>BAE5014</b>	BL1103A2	<b>BA2185</b>
E92Z-2001-A	<b>BA2110</b>	BB1102A2	<b>BAE5021</b>	BL1110A2	<b>BA2188</b>
ME6G9J-2M008-GA	<b>BA2313</b>	BB1122A2	<b>BAE5008</b>	BL1112A1	<b>BA2076</b>
YM21-2078-AA	<b>BAH0027</b>	BB1125A2	<b>BAE5013</b>	BL1113A2	<b>BA2056</b>
YM21-2078-AB	<b>BAH0027</b>	BB1129A1	<b>BAE5024</b>	BL1114A1	<b>BA2144</b>
YM21-2078-AC	<b>BAH0027</b>	BB1130A2	<b>BAE5005</b>	BL1114B1	<b>BA2144</b>
YM21-2K021-AA	<b>BA2269</b>	BB1131A2	<b>BAE5011</b>	BL1118A1	<b>BA2322</b>
YM21-2K021-BA	<b>BA2318</b>	BB1131A2	<b>BAE5025</b>	BL1122A3	<b>BA2037</b>
YM21-2M008-BA	<b>BA2200</b>	BB1132A1	<b>BAE5001</b>	BL1122A3	<b>BA2178</b>
YM2J-2K021-BA	<b>BA2318</b>	BB1135A1	<b>BAE5006</b>	BL1123A3	<b>BA2031</b>
YS61-2K021-DA	<b>BA2199</b>	BB1144A1	<b>BAE5016</b>	BL1123A3	<b>BA2038</b>
		BB1145A1	<b>BAE5030</b>	BL1123B3	<b>BA2031</b>
<b>FTE automotive</b>		BB1150A1	<b>BAE5027</b>	BL1123B3	<b>BA2038</b>
		BB1159A1	<b>BAE5002</b>	BL1125A2	<b>BA2189</b>
135.620E	<b>BAH0016</b>	BB1160A1	<b>BAE5026</b>	BL1125B2	<b>BA2189</b>
135E.639E.0	<b>BAH0033</b>	BB1162A1	<b>BAE5023</b>	BL1126A2	<b>BA2135</b>
140E.639E.0	<b>BAH0033</b>	BB1163A1	<b>BAE5042</b>	BL1138A4	<b>BA2024</b>
160.50.0	<b>BAH0003</b>	BB1170A1	<b>BAE5034</b>	BL1140A1	<b>BA2093</b>
160.51	<b>BAH0011</b>	BB1173A2	<b>BAE5012</b>	BL1140B1	<b>BA2093</b>
180.51.0	<b>BAH0015</b>	BB1175A1	<b>BAE5031</b>	BL1141A1	<b>BA2094</b>
180.51.1.0	<b>BAH0015</b>	BB1176A1	<b>BAE5037</b>	BL1151A4	<b>BA2034</b>
240.430.0	<b>BAH0024</b>	BB1216A1	<b>BAE5022</b>	BL1163A3	<b>BA2121</b>
270.621E.1	<b>BAH0026</b>	BB1218A2	<b>BAE5038</b>	BL1167A3	<b>BA2133</b>
280.427E.2	<b>BAH0006</b>	BB1222A1	<b>BAE5004</b>	BL1167B3	<b>BA2133</b>
280.632E.1	<b>BAH0025</b>	BB1223A1	<b>BAE5015</b>	BL1168A3	<b>BA2141</b>
280E.418E	<b>BAH0004</b>	BB1245A1	<b>BAE5009</b>	BL1168B3	<b>BA2141</b>
280E.427E.0	<b>BAH0006</b>	BB1246A1	<b>BAE5019</b>	BL1169A3	<b>BA2132</b>
285.621E.1	<b>BAH0012</b>	BB1249A1	<b>BAE5029</b>	BL1169B3	<b>BA2132</b>
290.50.5A	<b>BAH0008</b>	BB1273A2	<b>BAE5007</b>	BL1170A3	<b>BA2131</b>
295.505E.0	<b>BAH0030</b>	BB1275A1	<b>BAE5017</b>	BL1170B3	<b>BA2131</b>
295.621E.1	<b>BAH0013</b>	BB1293A1	<b>BAE5040</b>	BL1174B2	<b>BA2134</b>
300.50	<b>BAH0010</b>	BB1300A1	<b>BAE5010</b>	BL1175A4	<b>BA2028</b>
300E.512E.0	<b>BAH0029</b>	BB1301A1	<b>BAE5018</b>	BL1175B4	<b>BA2028</b>
305E.621E.1	<b>BAH0021</b>	BB1302A1	<b>BAE5028</b>	BL1184A2	<b>BA2086</b>
310.430E.1	<b>BAH0031</b>	BB1318A1	<b>BAE5039</b>	BL1185A2	<b>BA2134</b>
310E.436E.1	<b>BAH0010</b>	BB1319A1	<b>BAE5036</b>	BL1187A1	<b>BA2064</b>
330.621E.1.0	<b>BAH0014</b>	BB1328A1	<b>BAE5032</b>	BL1187A2	<b>BA2065</b>
340E.419E	<b>BAH0009</b>	BL1011A2	<b>BA2187</b>	BL1187B2	<b>BA2064</b>
340E.419EF	<b>BAH0009</b>	BL1012A1	<b>BA2062</b>	BL1187B2	<b>BA2065</b>
345E.621E.1	<b>BAH0022</b>	BL1022A1	<b>BA2162</b>	BL1193A3	<b>BA2032</b>
363E.425E.0	<b>BAH0020</b>	BL1022B1	<b>BA2162</b>	BL1194A3	<b>BA2017</b>
380E.826E.1	<b>BAH0019</b>	BL1031A1	<b>BA2106</b>	BL1194A4	<b>BA2228</b>
385.629E.0	<b>BAH0018</b>	BL1032A1	<b>BA2181</b>	BL1197A3	<b>BA2025</b>
400.519E.2	<b>BAH0032</b>	BL1034A3	<b>BA2037</b>	BL1198A1	<b>BA2030</b>
400.519E.3	<b>BAH0032</b>	BL1035A3	<b>BA2031</b>	BL1200A2	<b>BA2055</b>
410.445E.1	<b>BAH0017</b>	BL1035A3	<b>BA2038</b>	BL1200A2	<b>BA2083</b>
425E.446E.1	<b>BAH0001</b>	BL1035B3	<b>BA2031</b>	BL1200B2	<b>BA2055</b>

# Vergleichsliste

Liste des correspondances / Tabella di conversione codici / Lista de comparação /



Lista porównawcza numerów / Porovnávací seznam čísel

FTE automotive		FTE automotive		FTE automotive	
BL1200B2	BA2083	BL1286A2	BA2174	BL1400A1	BA2145
BL1201A2	BA2074	BL1287A2	BA2163	BL1400B1	BA2145
BL1202A2	BA2066	BL1299A1	BA2136	BL1403A1	BA2202
BL1202B2	BA2066	BL1299B1	BA2136	BL1404A3	BA2268
BL1203A2	BA2020	BL1302A1	BA2071	BL1405A2	BA2143
BL1203A2	BA2036	BL1305A3	BA2175	BL1406A1	BA2332
BL1204A2	BA2054	BL1307A2	BA2112	BL1406A2	BA2142
BL1204B2	BA2054	BL1309A2	BA2110	BL1406F5	BA2332
BL1209A1	BA2111	BL1313A2	BA2050	BL1411A2	BA2101
BL1209A2	BA2111	BL1315A1	BA2139	BL1412A4	BA2012
BL1209A2	BA2292	BL1318A2	BA2140	BL1424A2	BA2124
BL1212A4	BA2029	BL1319A1	BA2072	BL1438A2	BA2149
BL1212B4	BA2029	BL1319A2	BA2073	BL1439A2	BA2239
BL1217A1	BA2095	BL1320A4	BA2044	BL1440A2	BA2233
BL1219A4	BA2027	BL1320B4	BA2044	BL1441A2	BA2215
BL1219B4	BA2027	BL1322A2	BA2048	BL1462A3	BA2011
BL1220A2	BA2125	BL1323A2	BA2023	BL1467A2	BA2250
BL1220B2	BA2125	BL1323B2	BA2023	BL1470A2	BA2169
BL1224A2	BA2036	BL1324A1	BA2080	BL1471A2	BA2170
BL1224B2	BA2036	BL1325A1	BA2081	BL1474A3	BA2018
BL1226A2	BA2060	BL1327A3	BA2049	BL1475A3	BA2160
BL1229A2	BA2077	BL1327A4	BA2321	BL1475A4	BA2198
BL1229B2	BA2075	BL1327B3	BA2049	BL1475B3	BA2160
BL1229B2	BA2077	BL1328A3	BA2119	BL1475B4	BA2198
BL1229F1	BA2075	BL1329A2	BA2167	BL1476A1	BA2171
BL1230A1	BA2035	BL1335A4	BA2010	BL1476A2	BA2201
BL1231A2	BA2033	BL1338A2	BA2114	BL1477A1	BA2147
BL1231B2	BA2033	BL1339A1	BA2227	BL1477A2	BA2269
BL1233A2	BA2019	BL1347A3	BA2068	BL1480A1	BA2146
BL1243A1	BA2098	BL1348A2	BA2138	BL1480B1	BA2146
BL1243B1	BA2098	BL1350A3	BA2276	BL1481A1	BA2144
BL1246A3	BA2052	BL1350A4	BA2286	BL1481B1	BA2144
BL1246B3	BA2052	BL1352A3	BA2076	BL1482A2	BA2079
BL1248A2	BA2182	BL1353A2	BA2116	BL1483A4	BA2021
BL1254A1	BA2040	BL1354A2	BA2020	BL1484A1	BA2151
BL1255A1	BA2084	BL1355A2	BA2148	BL1485A1	BA2100
BL1255A2	BA2084	BL1357A1	BA2232	BL1487A4	BA2016
BL1255B1	BA2084	BL1358A2	BA2078	BL1489A2	BA2077
BL1255B2	BA2084	BL1361A4	BA2138	BL1490A4	BA2226
BL1256A4	BA2026	BL1362A2	BA2117	BL1524A1	BA2333
BL1256B4	BA2026	BL1365A2	BA2115	BL1524A2	BA2205
BL1257A2	BA2096	BL1366A2	BA2113	BL1525A1	BA2153
BL1257A2	BA2097	BL1367A3	BA2039	BL1525B1	BA2153
BL1260A2	BA2137	BL1368A2	BA2150	BL1526A2	BA2173
BL1260B2	BA2137	BL1369A2	BA2168	BL1527A2	BA2211
BL1263A2	BA2161	BL1369B2	BA2168	BL1531A2	BA2022
BL1263B2	BA2161	BL1374A2	BA2274	BL1593A3	BA2162
BL1264A1	BA2146	BL1380A2	BA2280	BL1612A2	BA2108
BL1264B1	BA2146	BL1381A4	BA2015	BL1613A2	BA2053
BL1266A2	BA2043	BL1385A2	BA2118	BL1614A1	BA2154
BL1268A1	BA2014	BL1388A2	BA2249	BL1614A2	BA2155
BL1277A2	BA2244	BL1389A2	BA2045	BL1614B1	BA2154
BL1279A3	BA2099	BL1390A2	BA2046	BL1617A4	BA2172
BL1279F5	BA2099	BL1391A2	BA2047	BL1644A2	BA2166
BL1281A2	BA2167	BL1392A1	BA2207	BL1651A1	BA2213
BL1282A2	BA2108	BL1399A1	BA2152	BL1652A4	BA2090

# Vergleichsliste

Liste des correspondances / Tabella di conversione codici / Lista de comparação /



Lista porównawcza numerów / Porovnávací seznam čísel

FTE automotive		FTE automotive		FTE automotive	
BL1665A1	BA2209	BL1797A2	BA2245	BL1966A1	BA2235
BL1665B1	BA2209	BL1800A3	BA2282	BL1966A1	BA2258
BL1666A3	BA2208	BL1812A4	BA2325	BL1967A4	BA2260
BL1668A1	BA2278	BL1813A1	BA2334	BL1968A3	BA2287
BL1668A4	BA2278	BL1817A2	BA2236	BL2002A2	BA2309
BL1678A1	BA2164	BL1821A3	BA2261	BL2010A4	BA2256
BL1679A2	BA2206	BL1825A1	BA2251	BL2018A4	BA2275
BL1680A2	BA2091	BL1828A3	BA2194	BL2019A4	BA2275
BL1681A2	BA2191	BL1829A4	BA2221	BL2022A3	BA2265
BL1682A2	BA2192	BL1830A4	BA2204	BL2043A4	BA2306
BL1683A1	BA2273	BL1831A2	BA2218	BL2044A4	BA2305
BL1684A2	BA2197	BL1832A2	BA2272	BL2045A4	BA2304
BL1685A4	BA2237	BL1833A2	BA2255	BS1010	BAR10151
BL1686A3	BA2089	BL1838A2	BA2246	BS1017	BAR10185
BL1688A1	BA2320	BL1840A4	BA2262	BS1046	BAR12106
BL1691A4	BA2217	BL1843A1	BA2271	BS1060	BAR13137
BL1695A4	BA2176	BL1845A2	BA2294	BS3121	BAR10189
BL1696A4	BA2176	BL1847A4	BA2013	BS3133	BAR11115
BL1702A1	BA2121	BL1850A3	BA2257	BS3205	BAR20115
BL1704A2	BA2122	BL1857A3	BA2289	BS3211	BAR13160
BL1706A1	BA2123	BL1857A4	BA2299	BS3236	BAR24112
BL1706F5	BA2123	BL1859A4	BA2241	BS3240	BAR10152
BL1716A1	BA2253	BL1860A4	BA2324	BS3243	BAR24103
BL1717A1	BA2279	BL1861A3	BA2323	BS3249	BAR12116
BL1727A2	BA2137	BL1864A2	BA2231	BS3305	BAR16100
BL1728A3	BA2219	BL1870A2	BA2242	BS3309	BAR20123
BL1731A4	BA2177	BL1871A2	BA2242	BS3317	BAR22118
BL1732A4	BA2177	BL1872A4	BA2243	BS3388	BAR13161
BL1733A1	BA2290	BL1873A4	BA2298	BS3434	BAR16105
BL1738A2	BA2190	BL1874A2	BA2252	BS3444	BAR11137
BL1739A2	BA2210	BL1875A2	BA2240	BS3446	BAR12117
BL1740A1	BA2164	BL1876A3	BA2284	BS3447	BAR09118
BL1741A2	BA2216	BL1876A4	BA2301	BS3449	BAR08104
BL1744A2	BA2184	BL1878A2	BA2270	BS3452	BAR20126
BL1746A2	BA2116	BL1880A2	BA2293	BS3464	BAR13167
BL1750A3	BA2220	BL1881A2	BA2331	BS3477	BAR10187
BL1751A2	BA2053	BL1889A3	BA2276	BS3480	BAR22122
BL1752A1	BA2224	BL1889A4	BA2286	BS3505	BAR08107
BL1771A3	BA2202	BL1890A3	BA2247	BS3507	BAR28102
BL1771A4	BA2200	BL1891A3	BA2089	BS3508	BAR20133
BL1771A4	BA2202	BL1894A4	BA2285	BS3511	BAR12127
BL1772A3	BA2202	BL1895A2	BA2195	BS3543	BAR24111
BL1773A4	BA2200	BL1896A4	BA2196	BS3544	BAR10191
BL1774A2	BA2318	BL1900A3	BA2230	BS3546	BAR20125
BL1776A1	BA2203	BL1905A3	BA2257	BS3583	BAR10115
BL1777A1	BA2199	BL1906A2	BA2259	BS3585	BAR20114
BL1778A4	BA2260	BL1910A1	BA2234	BS3589	BAR10178
BL1780A1	BA2254	BL1911A3	BA2017	BS3592	BAR11119
BL1780A2	BA2022	BL1926A4	BA2239	BS3593	BAR20142
BL1782A3	BA2288	BL1927A3	BA2214	BS3605	BAR20128
BL1784A1	BA2238	BL1930A2	BA2291	BS3611	BAR10196
BL1785A3	BA2095	BL1938A4	BA2307	BS3627	BAR09114
BL1786A2	BA2267	BL1951A4	BA2263	BS3639	BAR12124
BL1790A3	BA2225	BL1952A4	BA2264	BS3642	BAR22103
BL1793A3	BA2214	BL1959A2	BA2295	BS3645	BAR28101
BL1794A3	BA2229	BL1960A2	BA2326	BS3653	BAR12125

# Vergleichsliste

Liste des correspondances / Tabella di conversione codici / Lista de comparação /



Lista porównawcza numerów / Porovnávací seznam čísel

FTE automotive		FTE automotive		FTE automotive	
BS3680	BAR24115	BS4514	BAR12132	BS4735	BAR25113
BS3688	BAR20132	BS4524	BAR18105	BS4740	BAR13185
BS3712	BAR10111	BS4525	BAR26104	BS4744	BAR22168
BS3713	BAR13178	BS4527	BAR10115	BS4745	BAR12144
BS3727	BAR20147	BS4532	BAR10224	BS4750	BAR10227
BS3766	BAR22147	BS4535	BAR10211	BS4751	BAR12132
BS3767	BAR22108	BS4536	BAR19107	BS4752	BAR22152
BS3776	BAR10205	BS4539	BAR25110	BS4753	BAR09123
BS3786	BAR08106	BS4540	BAR28106	BS4763	BAR09133
BS3787	BAR24118	BS4541	BAR10217	BS4764	BAR22163
BS3792	BAR10215	BS4543	BAR22196	BS4768	BAR25123
BS3803	BAR12126	BS4544	BAR22161	BS4775	BAR24146
BS3804	BAR22115	BS4545	BAR16110	BS4795	BAR12149
BS3805	BAR10202	BS4546	BAR12142	BS4813	BAR24152
BS3820	BAR12137	BS4548	BAR18106	BS4814	BAR25131
BS3824	BAR15105	BS4552	BAR10210	BS4815	BAR10251
BS3825	BAR25105	BS4572	BAR24159	BS4816	BAR10250
BS3827	BAR10204	BS4577	BAR12141	BS4817	BAR26116
BS3833	BAR18107	BS4581	BAR12131	BS4869	BAR11151
BS3837	BAR26105	BS4583	BAR24131	BS4914	BAR10273
BS3838	BAR12128	BS4584	BAR24132	BS5010	BAR25137
BS3839	BAR22132	BS4587	BAR22158	BS5043	BAR09124
BS3840	BAR09120	BS4596	BAR10225	BS5118	BAR22206
BS3899	BAR21106	BS4599	BAR10219	BS5143	BAR24158
BS3907	BAR13166	BS4607	BAR13182	BS5146	BAR22160
BS3909	BAR24120	BS4615	BAR25124	BS5147	BAR19108
BS3911	BAR22100	BS4620	BAR20155	BS5149	BAR24164
BS3912	BAR26102	BS4623	BAR22159	BS5157	BAR09136
BS3919	BAR09122	BS4627	BAR10223	BS5160	BAR24170
BS3921	BAR26109	BS4628	BAR25114	BS5163	BAR24162
BS3929	BAR10201	BS4634	BAR10229	BS5164	BAR28129
BS3933	BAR22139	BS4636	BAR30101	BS5173	BAR08111
BS3935	BAR10261	BS4647	BAR18105	BS5182	BAR10258
BS3937	BAR10203	BS4662	BAR26106	BS5183	BAR10260
BS3951	BAR24129	BS4663	BAR10230	BS5184	BAR10259
BS3952	BAR24132	BS4664	BAR24139	BS5198	BAR26115
BS3953	BAR24131	BS4666	BAR24136	BS5199	BAR24161
BS3954	BAR19109	BS4668	BAR22150	BS5207	BAR32115
BS3960	BAR18113	BS4669	BAR22151	BS5216	BAR13194
BS4183	BAR19109	BS4670	BAR22162	BS5219	BAR24166
BS4338	BAR22148	BS4671	BAR10228	BS5221	BAR12154
BS4360	BAR26104	BS4673	BAR09114	BS5226	BAR26122
BS4361	BAR24127	BS4673B	BAR09114	BS5227	BAR22209
BS4362	BAR24138	BS4674	BAR22197	BS5228	BAR25138
BS4363	BAR18108	BS4676	BAR13184	BS5237	BAR28140
BS4372	BAR21105	BS4677	BAR20154	BS5238	BAR10285
BS4386	BAR22166	BS4678	BAR25119	BS5240	BAR22194
BS4396	BAR26108	BS4680	BAR10226	BS5241	BAR26120
BS4398	BAR18108	BS4699	BAR12142	BS5250	BAR30109
BS4406	BAR24171	BS4700	BAR16110	BS5276	BAR25142
BS4407	BAR10219	BS4727	BAR22172	BS5278	BAR30113
BS4415	BAR18124	BS4728	BAR28123	BS5282	BAR18137
BS4439	BAR28104	BS4731	BAR25115	BS5306	BAR11152
BS4503	BAR10232	BS4732	BAR24128	BS5307	BAR10261
BS4512	BAR12131	BS4733	BAR12138	BS5310	BAR30107
BS4513	BAR30101	BS4734	BAR18111	BS5311	BAR09137

# Vergleichsliste

Liste des correspondances / Tabella di conversione codici / Lista de comparação /

Lista porównawcza numerów / Porovnávací seznam čísel



FTE automotive		FTE automotive		FTE automotive	
BS5314	BAR20174	BZ1015W	BAV1028	R17028B1	BAW1705
BS5315	BAR20171	BZ1016W	BAV1030	R17028C1	BAW1705
BS5347	BAR28136	BZ1017W	BAV1016	R17029A1	BAW1701
BS5351	BAR20115	BZ1019W	BAV1029	R17036A1	BAW1706
BS5412	BAR25141	BZ1023W	BAV1049	R17042A1	BAW1707
BS5413	BAR12157	BZ1024W	BAV1017	R17043A1	BAW1704
BS5414	BAR28141	BZ1025W	BAV1006	R17044.8.1	BAW1703
BS5415	BAR10278	BZ1026W	BAV1005	R190003.2.1	BAW1914
BS5416	BAR25158	BZ1027W	BAV1011	R190004.2.1	BAW1914
BS5417	BAR22210	BZ1028W	BAV1003	R19031F1	BAW1901
BS5418	BAR25145	BZ1029W	BAV1009	R19054A1	BAW1902
BS5423	BAR12158	BZ1030W	BAV1010	R19062A1	BAW1909
BS5429	BAR10280	BZ1031W	BAV1036	R19063A1	BAW1910
BS5455	BAR25148	BZ1034W	BAV1004	R19064A1	BAW1913
BS5457	BAR24181	BZ1035W	BAV1004	R19065A1	BAW1912
BS5458	BAR30173	BZ1036W	BAV1008	R19066A1	BAW1909
BS5459	BAR20183	BZ1039W	BAV1033	R19067A1	BAW1910
BS5464	BAR28176	BZ1040W	BAV1033	R19070A1	BAW1906
BS5465	BAR28142	BZ1044W	BAV1035	R19079A1	BAW1905
BS5469	BAR28132	BZ1046W	BAV1031	R19082A1	BAW1904
BS5473	BAR22211	BZ1047W	BAV1007	R19088A1	BAW1903
BS5482	BAR09139	BZ1051W	BAV1032	R19096.8.1	BAW1907
BS5483	BAR09138	BZ1056W	BAV1014	R19097.8.1	BAW1911
BS5487	BAR25162	BZ1057W	BAV1012	R19098.8.1	BAW1911
BS5495	BAR12169	BZ1058W	BAV1013	R19099A1	BAW1908
BS7003	BAR26106	BZ1059W	BAV1015	R200004A1	BAW2001
BS7013	BAR10225	BZ1060W	BAV1034	R20004A1	BAW2001
BS7014	BAR10226	BZ1061W	BAV1034	R20043A1	BAW2004
BS7023	BAR22159	BZ1066W	BAV1054	R20051B1	BAW2002
BS7025	BAR20154	BZ1072W	BAV1046	R20054A1	BAW2005
BS7026	BAR10227	BZ1075W	BAV1023	R20055A1	BAW2006
BS7027	BAR13182	BZ1078W	BAV1038	R20058B1	BAW2005
BS7028	BAR25113	BZ1079W	BAV1039	R20059B1	BAW2006
BS7029	BAR22151	BZ1080W	BAV1020	R20065A1	BAW2008
BS7030	BAR22150	BZ1084W	BAV1050	R20067A1	BAW2010
BS7031	BAR09123	BZ1087W	BAV1051	R20070A1	BAW2003
BS7035	BAR25114	BZ1089W	BAV1018	R20071A1	BAW2009
BS7037	BAR24128	BZ1090W	BAV1019	R2093G1	BAW2007
BS7038	BAR18111	BZ1091W	BAV1025	R220005A1	BAW2202
BS7039	BAR12138	BZ1092W	BAV1040	R220007A1	BAW2203
BS7040	BAR25115	BZ1095W	BAV1021	R220019A1	BAW2205
BS7041	BAR22152	BZ1100W	BAV1026	R220025A1	BAW2207
BS7042	BAR10223	BZ1103W	BAV1042	R220028.8.1	BAW2204
BS7044	BAR24136	BZ1104W	BAV1043	R220029.8.1	BAW2206
BS7045	BAR22162	BZ1108W	BAV1041	R22085E1	BAW2201
BS7046	BAR10228	BZ1132W	BAV1044	R23031.2.1	BAW2301
BS7062	BAR10229	BZ1133W	BAV1045	R23031A1	BAW2301
BS7068	BAR12171	R14013A1	BAW1401	R25039A1	BAW2501
BS7077	BAR26138	R1408J1	BAW1401	R25039B1	BAW2501
BS7135B	BAR12184	R15013A1	BAW1501	R25048A1	BAW2500
BZ1001W	BAV1004	R15013B1	BAW1501	R26013.2.1	BAW2600
BZ1002W	BAV1002	R15013F1	BAW1501	R2702A1	BAW2600
BZ1003W	BAV1001	R15013G1	BAW1501	R28048A1	BAW2800
BZ1005W	BAV1035	R15026A1	BAW1501		
BZ1006W	BAV1007	R17010D1	BAW1702		
BZ1012W	BAV1027	R17011K1	BAW1701		



# Vergleichsliste

Liste des correspondances / Tabella di conversione codici / Lista de comparação /



Lista porównawcza numerów / Porovnávací seznam čísel

HONDA		HYUNDAI		JURID	
43022-S2A-000	BA2280	58101-1CA10	BA2292	361426J	BAE5014
43022-S2A-E50	BA2280	58101-22A00	BA2111	361450J	BAE5008
43022-S5A-E50	BA2280	58101-22A10	BA2111	361554J	BAE5020
43022-S5A-J00	BA2280	58101-24A00	BA2111	361570J	BAE5027
43022-S6D-000	BA2280	58101-24B00	BA2111	361576J	BAE5005
43022-S6D-E50	BA2280	58101-24C00	BA2111	361578J	BAE5001
43022-SL5-000	BA2280	58101-25A10	BA2292	362019J	BAE5024
43022-SM4-G00	BA2280	58101-28A10	BA2292	362218J	BAE5011
43022-SN7-000	BA2280	58101-29A40	BA2292	362220J	BAE5006
43022-SN7-E50	BA2280	58302-17A00	BA2291	362225J	BAE5013
43022-SN7-E50HE	BA2280	58302-1CA00	BA2291	362247J	BAE5014
43022-SV4-A00	BA2280	58302-1CA10	BA2291	362249J	BAE5020
43022-SV4-A20	BA2280	58302-26A00	BA2291	362285J	BAE5037
43022-SV4-E50	BA2280	58302-26A30	BA2291	362287J	BAE5031
43022-SV4-G00	BA2280	58302-2EA30	BA2291	362288J	BAE5030
43022-SV4-G21	BA2280	58302-2HA00	BA2291	362300J	BAE5021
43022-SV4-G22	BA2280	58302-38A20	BA2291	362301J	BAE5034
43022-SY8-A01	BA2280	58302-38A30	BA2291	362312J	BAE5016
43022-TM8-G01	BA2280	58302-39A40	BA2291	362318J	BAE5002
43300-ST3-E01	BAW1911	58302-3AA20	BA2291	362320J	BAE5022
43301-ST3-E01	BAW1911	58302-3KA30	BA2291	362337J	BAE5023
45022-S04-602	BA2274	58302-3KA40	BA2291	362338J	BAE5042
45022-S04-G00	BA2274	58330-25000	BAW1911	362340J	BAE5026
45022-S04-G02	BA2274	58380-25000	BAW1911	362341J	BAE5020
45022-S04-J02	BA2274			362363J	BAE5017
45022-S1A-E02	BA2278	<b>ISUZU</b>		362368J	BAE5026
45022-S1A-E50	BA2278			362377J	BAE5035
45022-S6D-E01	BA2010	8-94461-155-0	BA2114	362382J	BAE5019
45022-S6D-E50	BA2010			362384J	BAE5015
45022-S74-E10	BA2010	<b>IVECO</b>		362385J	BAE5009
45022-S74-E50	BA2010			362386J	BAE5004
45022-SA6-600	BA2111	1908407	BAV1054	362389J	BAE5012
45022-SA6-N50	BA2111			362391J	BAE5041
45022-SAA-E50	BA2274	<b>JAGUAR</b>		362392J	BAE5029
45022-SAA-E51	BA2274			362396J	BAE5038
45022-SAA-G00	BA2274	5W93 2200 AA	BA2235	362397J	BAE5007
45022-SR3-G00	BA2274	5W93 2200 AB	BA2235	362406J	BAE5010
45022-SR3-G01	BA2274	C2C 27271	BA2235	362410J	BAE5032
45022-ST3-E01	BA2010	C2S 17129	BA2224	362412J	BAE5039
45251-S5D-A10	BAR21105	C2S 17362	BA2225	362413J	BAE5036
45251-S6D-E10	BAR21105	C2S 20893	BA2225	362414J	BAE5018
45251-SCC-900	BAR21105	C2S 33408	BA2225	362415J	BAE5028
45251-SK7-A00	BAR21105	C2S 35270	BAR24161	362419J	BAE5040
45251-SK7-A10	BAR21105	C2S 35271	BAR12154	362426J	BAE5033
45251-SK7-J00	BAR21105	C2S 38068	BA2287	376560J	BAE5034
45251-SR0-A00	BAR21105	C2S 42667	BAR24161	561074J	BAR11115
45251-SR0-A10	BAR21105	C2S 42668	BAR12154	561087J	BAR10151
45251-ST3-E10	BAR21105	C2S 4566	BAR24161	561102J	BAR13137
45251-TG5-H00	BAR21105	C2S 49730	BAR12154	561116J	BAR10189
		C2S 9231	BAR12154	561135J	BAR16100
				561141J	BAR12106
				561142J	BAR10152
				561158J	BAR13161
<b>HYUNDAI</b>		<b>JURID</b>		561171J	BAR24103
51712-21350	BAR19109			561178J	BAR20123
51712-21B00	BAR19109	361213J	BAE5006	561235J	BAR12116
51712-24100	BAR19109	361216J	BAE5003		
51712-M2010	BAR24146	361342J	BAE5035		

# Vergleichsliste

Liste des correspondances / Tabella di conversione codici / Lista de comparação /



Lista porównawcza numerów / Porovnávací seznam čísel

JURID		JURID		JURID	
561238J	BAR13160	561555J	BAR08106	562005J	BAR10224
561244J	BAR22118	561589J	BAR10205	562005JC	BAR10224
561248J	BAR20115	561590J	BAR21106	562006J	BAR12127
561253J	BAR10187	561592J	BAR22148	562007J	BAR10211
561257J	BAR08104	561593J	BAR24171	562013J	BAR25110
561266J	BAR13167	561595J	BAR10219	562013JC	BAR25110
561308J	BAR20114	561610J	BAR24118	562014J	BAR10217
561312J	BAR10178	561615J	BAR10215	562014JC	BAR10217
561321J	BAR16105	561619J	BAR22100	562019J	BAR26106
561324J	BAR22122	561620J	BAR10203	562022J	BAR22166
561330J	BAR11137	561624J	BAR24131	562027J	BAR24139
561332J	BAR12117	561625J	BAR24132	562032J	BAR10215
561333J	BAR09118	561630J	BAR21105	562033J	BAR20155
561334J	BAR20126	561652J	BAR10204	562034J	BAR28106
561336J	BAR20125	561663J	BAR12137	562034JC	BAR28106
561344J	BAR10185	561672J	BAR18124	562035J	BAR22159
561359J	BAR08107	561673J	BAR22166	562035JC	BAR22159
561364J	BAR20133	561678J	BAR24120	562036J	BAR20154
561373J	BAR24112	561689J	BAR22139	562036JC	BAR20154
561375J	BAR10115	561690J	BAR13166	562038J	BAR12141
561380J	BAR11119	561691J	BAR22108	562039J	BAR22150
561387J	BAR22147	561696J	BAR12128	562040J	BAR22151
561388J	BAR12125	561696JC	BAR12128	562041J	BAR25113
561406J	BAR24111	561697J	BAR22132	562042J	BAR10230
561408J	BAR10191	561697JC	BAR22132	562043J	BAR25114
561409J	BAR20132	561698J	BAR09120	562044J	BAR13184
561448J	BAR20128	561698JC	BAR09120	562045J	BAR20133
561453J	BAR28102	561704J	BAR09122	562048J	BAR12144
561454J	BAR09114	561716J	BAR24129	562049J	BAR22168
561460J	BAR10111	561730J	BAR28104	562051J	BAR12149
561468J	BAR20142	561822J	BAR25124	562051JC	BAR12149
561469J	BAR12127	561824J	BAR24146	562052J	BAR25115
561476J	BAR12124	561857J	BAR18105	562052JC	BAR25115
561478J	BAR22103	561861J	BAR20142	562053J	BAR09123
561479J	BAR28101	561863J	BAR10261	562054J	BAR22162
561486J	BAR18107	561866J	BAR26102	562055J	BAR13185
561488J	BAR24115	561870J	BAR12131	562057J	BAR10223
561491J	BAR13178	561871J	BAR18113	562059J	BAR10229
561496J	BAR10196	561960J	BAR25119	562060J	BAR22152
561512J	BAR26105	561961J	BAR10225	562060JC	BAR22152
561513J	BAR20147	561962J	BAR10226	562062J	BAR10227
561521J	BAR19109	561963J	BAR09114	562062JC	BAR10227
561523J	BAR26109	561963JC	BAR09114	562065J	BAR10228
561547J	BAR15105	561965J	BAR22161	562066J	BAR28106
561547JC	BAR15105	561967J	BAR26104	562069J	BAR24152
561548J	BAR25105	561968J	BAR22158	562070J	BAR25131
561548JC	BAR25105	561969J	BAR24138	562071J	BAR10251
561549J	BAR10201	561980J	BAR10232	562072J	BAR10250
561549JC	BAR10201	561981J	BAR18106	562073J	BAR13182
561550J	BAR12126	561982J	BAR10210	562078J	BAR22172
561551J	BAR22115	561982JC	BAR10210	562079J	BAR18111
561551JC	BAR22115	561984J	BAR24127	562080J	BAR24128
561552J	BAR10202	561992J	BAR18108	562081J	BAR12138
561552JC	BAR10202	561997J	BAR21106	562088J	BAR24159
561553J	BAR30101	562003J	BAR19107	562089J	BAR10258
561554J	BAR12132	562003JC	BAR19107	562090J	BAR22160

# Vergleichsliste

Liste des correspondances / Tabella di conversione codici / Lista de comparação /



Lista porównawcza numerów / Porovnávací seznam čísel

JURID		JURID		JURID	
562090JC	BAR22160	562287J	BAR25124	571320J	BA2036
562093J	BAR10273	562290J	BAR20174	571321J	BA2019
562094J	BAR19108	562293J	BAR12171	571327J-AS	BA2023
562099J	BAR26116	562307J	BAR18137	571330D	BA2033
562101J	BAR32115	562318J	BAR22209	571330J	BA2033
562103J	BAR24158	562319J	BAR20183	571331D	BA2075
562104J	BAR24171	562320J	BAR24181	571331D	BA2077
562105J	BAR24162	562332J	BAR30173	571331J	BA2075
562115J	BAR26108	567760J	BAR22161	571331J	BA2077
562128J	BAR22194	567761J	BAR16110	571332D	BA2055
562129J	BAR26120	567771J	BAR12142	571332J	BA2055
562130J	BAR09137	567810J	BAR22196	571333D	BA2055
562132J	BAR25123	569120J	BAR12142	571333J	BA2055
562133J	BAR22163	569121J	BAR16110	571334D	BA2076
562134J	BAR30109	569122J	BAR22161	571334J	BA2076
562149J	BAR08111	571202J	BA2041	571335J	BA2076
562155J	BAR09136	571243J	BA2082	571335J-AS	BA2076
562156J	BAR12142	571255D	BA2109	571339D	BA2060
562165J	BAR22206	571255J	BA2109	571339J	BA2060
562171J	BAR09124	571255J-AS	BA2109	571344J	BA2093
562173J	BAR28123	571261J	BA2193	571346J	BA2040
562177J	BAR09133	571261J-AS	BA2193	571350J	BA2052
562178J	BAR22197	571271D	BA2185	571352D	BA2026
562180J	BAR24161	571271J	BA2185	571352J	BA2026
562188J	BAR25138	571271J-AS	BA2185	571352J-AS	BA2026
562190J	BAR28129	571272D	BA2101	571353D	BA2027
562192J	BAR10261	571272J	BA2101	571353J	BA2027
562192JC	BAR10261	571272J-AS	BA2101	571353J-AS	BA2027
562193J	BAR12154	571279D	BA2162	571355D	BA2125
562195J	BAR11152	571279J	BA2162	571355J	BA2125
562196J	BAR24166	571297D	BA2064	571355J-AS	BA2125
562198J	BAR26115	571297D	BA2065	571356D	BA2028
562199J	BAR25137	571297J	BA2064	571356J	BA2028
562200J	BAR30107	571297J	BA2065	571356J-AS	BA2028
562200JC	BAR30107	571300J	BA2189	571357D	BA2038
562204J	BAR11151	571300J-AS	BA2189	571357J	BA2038
562205J	BAR30113	571302D	BA2056	571357J-AS	BA2038
562212J	BAR28141	571302J	BA2056	571359D	BA2043
562213J	BAR10278	571302J-AS	BA2056	571359J	BA2043
562216J	BAR25141	571304J	BA2024	571359J-AS	BA2043
562224J	BAR28136	571306J	BA2086	571361D	BA2032
562229J	BAR12157	571306J-AS	BA2086	571361J	BA2032
562235J	BAR25145	571309J	BA2034	571361J-AS	BA2032
562237J	BAR22210	571313J	BA2050	571363J	BA2106
562238J	BAR12158	571315D	BA2131	571367D	BA2096
562240J	BAR25142	571315J	BA2131	571367J	BA2096
562241J	BAR28132	571315J-AS	BA2131	571367J-AS	BA2096
562243J	BAR28142	571316D	BA2133	571376D	BA2037
562244J	BAR26122	571316J	BA2133	571376J	BA2037
562258J	BAR12169	571316J-AS	BA2133	571376J-AS	BA2037
562261J	BAR09139	571317D	BA2132	571380D	BA2025
562262J	BAR22211	571317J	BA2132	571380J	BA2025
562263J	BAR10280	571317J-AS	BA2132	571380J-AS	BA2025
562264J	BAR10285	571319D	BA2020	571382D	BA2029
562277J	BAR25158	571319J	BA2020	571382J	BA2029
562278J	BAR25148	571320D	BA2036	571382J-AS	BA2029

# Vergleichsliste

Liste des correspondances / Tabella di conversione codici / Lista de comparação /



Lista porównawcza numerów / Porovnávací seznam čísel

JURID		JURID		JURID	
571387J	BA2054	571523D	BA2073	571833J-AS	BA2134
571387J-AS	BA2054	571523J	BA2073	571838J	BA2047
571388J	BA2161	571524D	BA2066	571838J-AS	BA2047
571389J	BA2095	571524J	BA2066	571839D	BA2045
571391D	BA2137	571525D	BA2074	571839J	BA2045
571391J	BA2137	571525J	BA2074	571840D	BA2046
571391J-AS	BA2137	571525J-AS	BA2074	571840J	BA2046
571398J	BA2099	571526D	BA2023	571843J	BA2079
571405D	BA2048	571526J	BA2023	571844J	BA2149
571405J	BA2048	571527J	BA2053	571844J-AS	BA2149
571406D	BA2020	571528D	BA2072	571845J	BA2250
571406J	BA2020	571528J	BA2072	571845J-AS	BA2250
571407D	BA2098	571536D	BA2144	571846J	BA2233
571407J	BA2098	571536J	BA2144	571846J-AS	BA2233
571409J	BA2035	571539J	BA2134	571847D	BA2049
571411J	BA2108	571539J-AS	BA2134	571847J	BA2049
571412J	BA2146	571540D	BA2039	571847J-AS	BA2049
571413J	BA2182	571540J	BA2039	571848D	BA2141
571413J-AS	BA2182	571542J	BA2188	571848J	BA2141
571414J	BA2014	571542J-AS	BA2188	571855J	BA2030
571421J	BA2227	571545J-AS	BA2054	571864J	BA2037
571425D	BA2107	571546J	BA2054	571868J	BA2027
571425J	BA2107	571546J-AS	BA2054	571873J	BA2166
571425J-AS	BA2107	571554J	BA2162	571873J-AS	BA2166
571435J	BA2161	571554J-AS	BA2162	571875J	BA2202
571436J	BA2011	571555J	BA2094	571875J	BA2247
571437J	BA2012	571555J-AS	BA2094	571875J-AS	BA2202
571438J	BA2010	571559J-AS	BA2027	571876J	BA2168
571439J	BA2187	571560J	BA2029	571876J-AS	BA2168
571456J	BA2181	571560J-AS	BA2029	571877J	BA2150
571457J	BA2244	571722J	BA2163	571877J-AS	BA2150
571458J	BA2322	571722J-AS	BA2163	571880J	BA2169
571462J	BA2052	571725J	BA2084	571880J-AS	BA2169
571463D	BA2062	571725J-AS	BA2084	571882J	BA2142
571463J	BA2062	571726D	BA2084	571883J	BA2143
571464J	BA2064	571726J	BA2084	571887J	BA2142
571473D	BA2097	571726J-AS	BA2084	571893J	BA2073
571473J	BA2097	571743D	BA2074	571897D	BA2015
571473J-AS	BA2097	571743J	BA2074	571897J	BA2015
571476D	BA2050	571745D	BA2081	571898D	BA2016
571476J	BA2050	571745J	BA2081	571898J	BA2016
571477J	BA2174	571746D	BA2080	571899D	BA2099
571477J-AS	BA2174	571746J	BA2080	571900J	BA2147
571492D	BA2136	571749D	BA2071	571902J	BA2151
571492J	BA2136	571749J	BA2071	571902J-AS	BA2151
571492J-AS	BA2136	571754J	BA2276	571904J-AS	BA2048
571493J	BA2175	571755J	BA2286	571906D	BA2017
571509D	BA2140	571757J	BA2078	571906J	BA2017
571509J	BA2140	571816J	BA2126	571910J	BA2215
571509J-AS	BA2140	571828D	BA2044	571910J-AS	BA2215
571511J	BA2013	571828J	BA2044	571911D	BA2083
571512J	BA2135	571828J-AS	BA2044	571911J	BA2083
571521J	BA2068	571832D	BA2139	571912J	BA2100
571521J-AS	BA2068	571832J	BA2139	571912J-AS	BA2100
571522D	BA2138	571833D	BA2134	571913J	BA2146
571522J	BA2138	571833J	BA2134	571914J	BA2144

# Vergleichsliste

Liste des correspondances / Tabella di conversione codici / Lista de comparação /



Lista porównawcza numerów / Porovnávací seznam čísel

JURID		JURID		JURID	
571915D	BA2145	571974J	BA2334	572434J	BA2118
571915J	BA2145	571975J	BA2211	572447J	BA2249
571918J	BA2167	571976D	BA2010	572450J	BA2293
571918J-AS	BA2167	571976J	BA2010	572468J	BA2121
571919D	BA2021	571981J	BA2260	572485J	BA2295
571919J	BA2021	571981J-AS	BA2260	572491J	BA2270
571919J-AS	BA2021	571982D	BA2172	572492J	BA2331
571920J	BA2207	571982J	BA2172	572516J	BA2326
571921J	BA2148	571984J	BA2205	573002J	BA2169
571922J	BA2022	571985J	BA2154	573002J-AS	BA2169
571922J-AS	BA2022	571986J	BA2177	573003J	BA2253
571923J	BA2152	571986J-AS	BA2177	573003J-AS	BA2253
571925J	BA2164	571987J-AS	BA2177	573005J	BA2212
571925J-AS	BA2164	571988J	BA2206	573006J	BA2198
571929J	BA2154	571988J-AS	BA2206	573008J	BA2219
571930J	BA2090	571989J-AS	BA2218	573010J	BA2197
571930J-AS	BA2090	571990J-AS	BA2245	573011J	BA2210
571931J	BA2090	571992J	BA2267	573012J	BA2225
571931J-AS	BA2090	571992J-AS	BA2267	573013J	BA2224
571932J	BA2320	571994J-AS	BA2190	573014J	BA2271
571932J-AS	BA2320	571995J	BA2217	573017J	BA2288
571934J	BA2171	571996D	BA2203	573018J	BA2238
571934J	BA2201	571996J	BA2203	573020J	BA2224
571935J	BA2333	571998D	BA2208	573021J	BA2279
571936J	BA2170	571998J	BA2208	573022J	BA2269
571939D	BA2153	572122J	BA2227	573030J	BA2214
571939J	BA2153	572138J	BA2280	573030J-AS	BA2214
571940J	BA2268	572145J	BA2115	573031J	BA2229
571941J	BA2226	572210J	BA2113	573032J	BA2017
571944J	BA2176	572227J	BA2114	573034J	BA2191
571944J-AS	BA2176	572255J	BA2121	573035J	BA2192
571945J	BA2176	572257J	BA2232	573037J	BA2172
571945J-AS	BA2176	572268J	BA2111	573038J	BA2200
571946J	BA2091	572269J	BA2292	573039J	BA2237
571947J	BA2290	572271J	BA2114	573041J	BA2199
571947J-AS	BA2290	572272J	BA2114	573042J	BA2315
571948J	BA2322	572280J	BA2112	573047J	BA2318
571949J	BA2332	572281J	BA2112	573047J-AS	BA2318
571950J	BA2216	572317J	BA2110	573048J	BA2247
571950J-AS	BA2216	572324J	BA2274	573049J	BA2200
571954J	BA2089	572325J	BA2118	573050J	BA2321
571954J-AS	BA2089	572333J	BA2116	573051J	BA2089
571955J	BA2160	572336J	BA2110	573052J	BA2244
571959D	BA2108	572370J	BA2249	573053J	BA2213
571959J	BA2108	572381J	BA2117	573055J	BA2261
571959J-AS	BA2108	572382J	BA2119	573056J	BA2272
571960J	BA2053	572396J	BA2113	573058J	BA2254
571960J-AS	BA2053	572402J	BA2123	573058J-AS	BA2254
571961J-AS	BA2184	572403J	BA2122	573059J	BA2247
571964J	BA2084	572405J	BA2294	573060J	BA2325
571967D	BA2209	572407J	BA2122	573065J	BA2228
571967J	BA2209	572408J	BA2122	573075D	BA2299
571968J	BA2173	572422J	BA2273	573075J	BA2299
571969J	BA2018	572428J-AS	BA2278	573082J	BA2220
571971D	BA2155	572429J-AS	BA2278	573083J	BA2282
571971J	BA2155	572430J	BA2010	573089D	BA2236

# Vergleichsliste

Liste des correspondances / Tabella di conversione codici / Lista de comparação /



Lista porównawcza numerów / Porovnávací seznam čísel

JURID		JURID		LADA	
573089J	BA2236	581303J	BAV1003	2101-3501089	BA2041
573091J	BA2221	581304J	BAV1004	2101-3501090	BA2041
573092J	BA2204	581305J	BAV1001	2108-3501070	BAR12125
573092J-AS	BA2204	581329J	BAV1003	2108-3501080	BA2040
573093J-AS	BA2164	581330J	BAV1005	2108-3501089	BA2040
573095J-AS	BA2022	581331J	BAV1006	21100-3501089	BA2040
573096J	BA2285	581332J	BAV1004	2110-3501080	BA2040
573105J	BA2303	581333J	BAV1004	2110-3501089	BA2040
573106J	BA2201	581337J	BAV1028		
573107J	BA2251	581338J	BAV1029	<b>LAND ROVER</b>	
573110D	BA2262	581341J	BAV1027		
573110J	BA2262	581345J	BAV1031	GWC1821	BAW2007
573113J	BA2241	581349J	BAV1051	LR004936	BA2314
573114J	BA2324	581350J	BAV1033	SEM000024	BAV1055
573115D	BA2323	581353J	BAV1032	SFP000120	BA2167
573115J	BA2323	581357J	BAV1019	SML100070	BAW2007
573120J	BA2225	581361J	BAV1024	SOE000025	BAV1056
573122J	BA2194	581362J	BAV1050	STC8571	BA2187
573124J	BA2230	581365J	BAV1018	STC9190	BA2187
573125J	BA2284	581367J	BAV1021		
573127J	BA2298	581368J	BAV1047	<b>LUCAS (TRW)</b>	
573128J-AS	BA2195	581369J	BAV1036		
573130J	BA2334	581370J	BAV1049	BWA108	BAW1401
573135J-AS	BA2296	581371J	BAV1030	BWA108A	BAW1401
573136J-AS	BA2308	581372J	BAV1015	BWA129	BAW1704
573137J-AS	BA2307	581373J	BAV1017	BWA130	BAW1706
573138J-AS	BA2311	581374J	BAV1011	BWA144	BAW1911
573139J	BA2309	581375J	BAV1014	BWA145	BAW1911
573139J-AS	BA2309	581376J	BAV1016	BWB111	BAW1501
573145J	BA2246	581377J	BAV1010	BWB111A	BAW1501
573151J	BA2252	581378J	BAV1013	BWC107	BAW1701
573152J-AS	BA2204	581379J	BAV1046	BWC107A	BAW1701
573153J	BA2255	581380J	BAV1009	BWC115	BAW1705
573158J	BA2196	581381J	BAV1012	BWC187	BAW1703
573159J-AS	BA2242	581383J	BAV1023	BWC189	BAW1702
573160J-AS	BA2242	581384J	BAV1026	BWC243	BAW1707
573161J-AS	BA2190	581386J	BAV1020	BWD110	BAW1902
573164J	BA2283	581388J	BAV1005	BWD113	BAW1905
573169J	BA2072	581389J	BAV1006	BWD113A	BAW1905
573171J	BA2289	581394J	BAV1025	BWD119	BAW1904
573183J-AS	BA2214	581395J	BAV1040	BWD119A	BAW1904
573184J-AS	BA2229	587010J	BAV1008	BWD121	BAW1906
573188J-AS	BA2252			BWD122	BAW1903
573189J-AS	BA2245	<b>KIA</b>		BWD123	BAW1909
573206J	BA2231			BWD124	BAW1910
573214J	BA2286	51712-M2010	BAR24146	BWD129	BAW1913
573220J	BA2327	58302-1FE00	BA2291	BWD130	BAW1912
573260J	BA2275	58302-1PA30	BA2194	BWD133	BAW1909
573274J	BA2265	58302-2GA00	BA2291	BWD134	BAW1910
573275J	BA2306	58302-3CA10	BA2291	BWD138	BAW2002
573276J	BA2305	K0BA2-33-28Z	BA2115	BWD195	BAW1901
573277J	BA2304			BWD227	BAW1911
573295J	BA2335	<b>LADA</b>		BWD228	BAW1911
581300J	BAV1007			BWD287	BAW1911
581301J	BAV1002	2101-3103002	BAR11115	BWD288	BAW1911
581302J	BAV1035	2101-3501070	BAR11115	BWD289	BAW1902

# Vergleichsliste

Liste des correspondances / Tabella di conversione codici / Lista de comparação /



Lista porównawcza numerów / Porovnávací seznam čísel

LUCAS (TRW)		LUCAS (TRW)		LUCAS (TRW)	
BWD302	<b>BAW1908</b>	DF1118	<b>BAR16105</b>	DF1622BP	<b>BAR24131</b>
BWD303	<b>BAW1907</b>	DF1120	<b>BAR08107</b>	DF1623	<b>BAR24132</b>
BWD306	<b>BAW1903</b>	DF1120BP	<b>BAR08107</b>	DF1623BP	<b>BAR24132</b>
BWD312	<b>BAW1914</b>	DF1122	<b>BAR09122</b>	DF1625	<b>BAR24115</b>
BWD314	<b>BAW1914</b>	DF1122BP	<b>BAR09122</b>	DF1625BP	<b>BAR24115</b>
BWD320	<b>BAW1902</b>	DF1217	<b>BAR10187</b>	DF1649	<b>BAR24112</b>
BWD717	<b>BAW1914</b>	DF1220	<b>BAR20133</b>	DF1654	<b>BAR10115</b>
BWD718	<b>BAW1911</b>	DF1220BP	<b>BAR20133</b>	DF1658	<b>BAR10196</b>
BWD719	<b>BAW1911</b>	DF1221	<b>BAR20132</b>	DF1658BP	<b>BAR10196</b>
BWF137	<b>BAW2010</b>	DF1221BP	<b>BAR20132</b>	DF1659	<b>BAR20147</b>
BWF145	<b>BAW2004</b>	DF1516	<b>BAR12106</b>	DF1674	<b>BAR10189</b>
BWF145A	<b>BAW2004</b>	DF1517	<b>BAR20123</b>	DF1674BP	<b>BAR10189</b>
BWF148	<b>BAW2006</b>	DF1517BP	<b>BAR20123</b>	DF1697	<b>BAR26105</b>
BWF149	<b>BAW2005</b>	DF1518	<b>BAR10151</b>	DF1723	<b>BAR11115</b>
BWF165	<b>BAW2002</b>	DF1521	<b>BAR13160</b>	DF1745	<b>BAR11119</b>
BWF168	<b>BAW2005</b>	DF1523	<b>BAR20114</b>	DF1746	<b>BAR20142</b>
BWF169	<b>BAW2006</b>	DF1526	<b>BAR10178</b>	DF1747	<b>BAR12127</b>
BWF170	<b>BAW2005</b>	DF1529	<b>BAR10111</b>	DF1747BP	<b>BAR12127</b>
BWF171	<b>BAW2006</b>	DF1529BP	<b>BAR10111</b>	DF1748	<b>BAR12125</b>
BWF193	<b>BAW2007</b>	DF1530	<b>BAR22118</b>	DF1748BP	<b>BAR12125</b>
BWF252	<b>BAW2001</b>	DF1530BP	<b>BAR22118</b>	DF1958	<b>BAR19109</b>
BWF254	<b>BAW2008</b>	DF1532	<b>BAR13178</b>	DF1965	<b>BAR26109</b>
BWF261	<b>BAW2009</b>	DF1532BP	<b>BAR13178</b>	DF2550	<b>BAR22122</b>
BWF262	<b>BAW2003</b>	DF1533	<b>BAR20128</b>	DF2550BP	<b>BAR22122</b>
BWF278	<b>BAW2008</b>	DF1533BP	<b>BAR20128</b>	DF2555	<b>BAR12124</b>
BWF303	<b>BAW2008</b>	DF1537	<b>BAR12126</b>	DF2556	<b>BAR22103</b>
BWF315	<b>BAW2009</b>	DF1537BP	<b>BAR12126</b>	DF2556BP	<b>BAR22103</b>
BWF335	<b>BAW2009</b>	DF1538	<b>BAR22115</b>	DF2558	<b>BAR28101</b>
BWH232	<b>BAW2203</b>	DF1539	<b>BAR10202</b>	DF2563	<b>BAR09114</b>
BWH241	<b>BAW2201</b>	DF1540	<b>BAR10203</b>	DF2566	<b>BAR22147</b>
BWH311	<b>BAW2202</b>	DF1540BP	<b>BAR10203</b>	DF2576	<b>BAR18107</b>
BWH373	<b>BAW2205</b>	DF1569	<b>BAR13167</b>	DF2581	<b>BAR08106</b>
BWH391	<b>BAW2207</b>	DF1573	<b>BAR13137</b>	DF2586	<b>BAR21106</b>
BWH395	<b>BAW2204</b>	DF1574	<b>BAR10185</b>	DF2592	<b>BAR10215</b>
BWH396	<b>BAW2206</b>	DF1577	<b>BAR16100</b>	DF2598	<b>BAR13166</b>
BWK103	<b>BAW2301</b>	DF1581	<b>BAR12117</b>	DF2599	<b>BAR22108</b>
BWL112	<b>BAW2501</b>	DF1581BP	<b>BAR12117</b>	DF2601	<b>BAR22139</b>
BWL204	<b>BAW2500</b>	DF1583	<b>BAR09118</b>	DF2601BP	<b>BAR22139</b>
BWL290	<b>BAW2500</b>	DF1583BP	<b>BAR09118</b>	DF2602	<b>BAR30101</b>
BWN240	<b>BAW2600</b>	DF1584	<b>BAR11137</b>	DF2611	<b>BAR12137</b>
BWN245	<b>BAW2800</b>	DF1584BP	<b>BAR11137</b>	DF2614	<b>BAR10204</b>
BWN523	<b>BAW2600</b>	DF1586	<b>BAR28102</b>	DF2619	<b>BAR22100</b>
DF1002	<b>BAR24103</b>	DF1596	<b>BAR24118</b>	DF2622	<b>BAR24120</b>
DF1002BP	<b>BAR24103</b>	DF1597	<b>BAR12132</b>	DF2622BP	<b>BAR24120</b>
DF1013	<b>BAR12116</b>	DF1607	<b>BAR10152</b>	DF2645	<b>BAR28104</b>
DF1013BP	<b>BAR12116</b>	DF1607BP	<b>BAR10152</b>	DF2645BP	<b>BAR28104</b>
DF1015	<b>BAR08104</b>	DF1608	<b>BAR13161</b>	DF2650	<b>BAR15105</b>
DF1015BP	<b>BAR08104</b>	DF1608BP	<b>BAR13161</b>	DF2651	<b>BAR10201</b>
DF1016	<b>BAR20125</b>	DF1609	<b>BAR20115</b>	DF2652	<b>BAR25105</b>
DF1016BP	<b>BAR20125</b>	DF1609BP	<b>BAR20115</b>	DF2652BP	<b>BAR25105</b>
DF1017	<b>BAR20126</b>	DF1613	<b>BAR10191</b>	DF2653	<b>BAR09120</b>
DF1017BP	<b>BAR20126</b>	DF1613BP	<b>BAR10191</b>	DF2653BP	<b>BAR09120</b>
DF1030	<b>BAR10219</b>	DF1614	<b>BAR24111</b>	DF2654	<b>BAR12128</b>
DF1032	<b>BAR22148</b>	DF1614BP	<b>BAR24111</b>	DF2655	<b>BAR10261</b>
DF1032BP	<b>BAR22148</b>	DF1620	<b>BAR24112</b>	DF2655BP	<b>BAR10261</b>
DF1033	<b>BAR24171</b>	DF1622	<b>BAR24131</b>	DF2656	<b>BAR22132</b>

# Vergleichsliste

Liste des correspondances / Tabella di conversione codici / Lista de comparação /

Lista porównawcza numerów / Porovnávací seznam čísel



LUCAS (TRW)		LUCAS (TRW)		LUCAS (TRW)	
DF2658	BAR22158	DF2796	BAR26106	DF4082	BAR10229
DF2658BP	BAR22158	DF2796BP	BAR26106	DF4087	BAR12142
DF2663	BAR10205	DF2797	BAR22162	DF4087S	BAR12142
DF2665	BAR18105	DF2797BP	BAR22162	DF4088	BAR16110
DF2671	BAR26102	DF2798	BAR24136	DF4088S	BAR16110
DF2683	BAR25124	DF2803	BAR22151	DF4089	BAR22196
DF2686	BAR20142	DF2803BP	BAR22151	DF4089BPS	BAR22196
DF2704	BAR24129	DF2804	BAR22150	DF4089S	BAR22196
DF2714	BAR12131	DF2804BP	BAR22150	DF4109	BAR24171
DF2716	BAR26104	DF2805	BAR09123	DF4110	BAR24158
DF2716BP	BAR26104	DF2805BP	BAR09123	DF4111	BAR24162
DF2719	BAR18113	DF2806	BAR22152	DF4119	BAR24164
DF2721	BAR24127	DF2806BP	BAR22152	DF4126	BAR10259
DF2722	BAR24138	DF2808	BAR13184	DF4134	BAR12149
DF2728	BAR18108	DF2809	BAR24128	DF4134BP	BAR12149
DF2734	BAR22197	DF2810	BAR18111	DF4135	BAR09136
DF2752	BAR12141	DF2812	BAR28106	DF4147	BAR24161
DF2752BP	BAR12141	DF2813	BAR10217	DF4147BP	BAR24161
DF2753	BAR20147	DF2815	BAR13185	DF4148S	BAR32115
DF2753BP	BAR20147	DF2815BP	BAR13185	DF4150	BAR26116
DF2754	BAR20155	DF3021	BAR21105	DF4164	BAR24171
DF2754BP	BAR20155	DF3089	BAR22166	DF4165	BAR24166
DF2755	BAR10232	DF3112	BAR26108	DF4165BP	BAR24166
DF2755BP	BAR10232	DF3122	BAR26108	DF4166	BAR25138
DF2757	BAR09114	DF4007	BAR18124	DF4166BP	BAR25138
DF2757BP	BAR09114	DF4026	BAR10224	DF4180	BAR25110
DF2765	BAR13182	DF4026BP	BAR10224	DF4181	BAR28106
DF2765BP	BAR13182	DF4027	BAR25113	DF4183	BAR26120
DF2767	BAR19107	DF4032	BAR24146	DF4183BP	BAR26120
DF2768	BAR10227	DF4034	BAR12144	DF4184	BAR22194
DF2769	BAR22159	DF4035	BAR22168	DF4184BP	BAR22194
DF2771	BAR10210	DF4036	BAR22172	DF4185	BAR09137
DF2772	BAR10225	DF4036BP	BAR22172	DF4185X	BAR25137
DF2772BP	BAR10225	DF4038	BAR10258	DF4186	BAR10261
DF2773	BAR10226	DF4039	BAR10260	DF4186BP	BAR10261
DF2776	BAR25114	DF4042	BAR24152	DF4187	BAR30109
DF2776BP	BAR25114	DF4042BP	BAR24152	DF4187BPS	BAR30109
DF2777	BAR10223	DF4045	BAR25115	DF4187S	BAR30109
DF2778	BAR25119	DF4047	BAR12138	DF4188	BAR10273
DF2778BPS	BAR25119	DF4048	BAR25131	DF4202	BAR22206
DF2778S	BAR25119	DF4050	BAR10251	DF4206	BAR25123
DF2779	BAR25110	DF4051	BAR10250	DF4208	BAR13194
DF2780	BAR18106	DF4051BP	BAR10250	DF4209	BAR30113
DF2780BP	BAR18106	DF4052	BAR09133	DF4209S	BAR30113
DF2781	BAR10230	DF4052BP	BAR09133	DF4212	BAR22209
DF2782	BAR24139	DF4053	BAR28123	DF4213	BAR10211
DF2782BP	BAR24139	DF4053S	BAR28123	DF4213BP	BAR10211
DF2783	BAR20154	DF4054	BAR24159	DF4218	BAR12154
DF2784	BAR10229	DF4054BP	BAR24159	DF4218BP	BAR12154
DF2784BP	BAR10229	DF4055	BAR22160	DF4223	BAR08111
DF2785	BAR24132	DF4062	BAR09124	DF4225	BAR11152
DF2786	BAR24131	DF4064	BAR25123	DF4225BP	BAR11152
DF2786BP	BAR24131	DF4065	BAR22163	DF4235	BAR22151
DF2790	BAR22161	DF4069	BAR19108	DF4236	BAR20174
DF2794	BAR10228	DF4081	BAR24136	DF4236BP	BAR20174
DF2794BP	BAR10228	DF4081BP	BAR24136	DF4238	BAR26122



# Vergleichsliste

Liste des correspondances / Tabella di conversione codici / Lista de comparação /



Lista porównawcza numerów / Porovnávací seznam čísel

LUCAS (TRW)		LUCAS (TRW)		LUCAS (TRW)	
DF4246	BAR25142	DF4558	BAR12169	GDB1128	BA2117
DF4246BP	BAR25142	DF4570	BAR30101	GDB113	BA2174
DF4247	BAR20171	DF4704	BAR24192	GDB1139	BA2118
DF4247BP	BAR20171	DF4744	BAR28140	GDB114	BA2048
DF4248	BAR30107	DF4772	BAR28123	GDB1143	BA2116
DF4248BPS	BAR30107	DF4786	BAR26120	GDB1148	BA2047
DF4248S	BAR30107	DF7026	BAR10227	GDB1159	BA2244
DF4249BPS	BAR28129	DF7174	BAR10280	GDB1163	BA2052
DF4249S	BAR28129	DF7299	BAR16110	GDB1164	BA2274
DF4253	BAR18137	DF7318	BAR22159	GDB1170	BA2113
DF4253BP	BAR18137	GDB1012	BA2113	GDB1189	BA2053
DF4255	BAR24158	GDB1024	BA2115	GDB1192	BA2138
DF4257	BAR28136	GDB1030	BA2050	GDB1193	BA2015
DF4257BP	BAR28136	GDB1031	BA2097	GDB1194	BA2016
DF4258S	BAR30113	GDB1032	BA2066	GDB1196	BA2017
DF4261	BAR28176	GDB1033	BA2074	GDB1198	BA2268
DF4261BP	BAR28176	GDB1037	BA2110	GDB1200	BA2148
DF4262	BAR25137	GDB1040	BA2136	GDB1203	BA2013
DF4262BPS	BAR25137	GDB1041	BA2107	GDB1204	BA2147
DF4262S	BAR25137	GDB1044	BA2038	GDB1205	BA2150
DF4263	BAR10278	GDB1048	BA2037	GDB1206	BA2202
DF4266	BAR12157	GDB1049	BA2135	GDB1210	BA2142
DF4271	BAR12158	GDB1050	BA2052	GDB1211	BA2143
DF4275S	BAR28132	GDB1055	BA2017	GDB1212	BA2315
DF4293	BAR25141	GDB1059	BA2232	GDB1214	BA2011
DF4294	BAR22210	GDB106	BA2062	GDB1215	BA2168
DF4295	BAR25145	GDB1063	BA2280	GDB1216	BA2079
DF4312	BAR22211	GDB1067	BA2101	GDB1218	BA2145
DF4313	BAR25162	GDB1078	BA2055	GDB1219	BA2141
DF4316	BAR28140	GDB1079	BA2077	GDB1220	BA2149
DF4318	BAR25148	GDB1080	BA2080	GDB1221	BA2146
DF4321	BAR22161	GDB1083	BA2010	GDB1222	BA2144
DF4323	BAR26115	GDB1084	BA2081	GDB1247	BA2106
DF4335	BAR09139	GDB1088	BA2012	GDB1258	BA2053
DF4345	BAR24170	GDB1092	BA2049	GDB1259	BA2016
DF4356	BAR10280	GDB1093	BA2187	GDB1260	BA2021
DF4357	BAR10285	GDB1094	BA2044	GDB1261	BA2166
DF4359	BAR24181	GDB1099	BA2071	GDB1262	BA2233
DF4360	BAR20183	GDB1100	BA2108	GDB1263	BA2215
DF4361	BAR30173	GDB1101	BA2078	GDB1264	BA2169
DF4379	BAR09138	GDB1103	BA2109	GDB1265	BA2170
DF4381	BAR12171	GDB1104	BA2140	GDB1266	BA2160
DF4382	BAR12116	GDB1105	BA2045	GDB1267	BA2017
DF4424	BAR25162	GDB1106	BA2046	GDB1270	BA2022
DF4426	BAR25148	GDB1107	BA2139	GDB1271	BA2207
DF4439	BAR20115	GDB1108	BA2138	GDB1274	BA2152
DF4445	BAR26138	GDB1112	BA2286	GDB1275	BA2333
DF4445S	BAR26138	GDB1113	BA2119	GDB1277	BA2083
DF4457	BAR24192	GDB1114	BA2068	GDB1278	BA2151
DF4457BP	BAR24192	GDB1115	BA2072	GDB1279	BA2100
DF4463	BAR10304	GDB1115	BA2073	GDB1280	BA2039
DF4464	BAR25158	GDB1118	BA2166	GDB1282	BA2171
DF4474	BAR10304	GDB1119	BA2167	GDB1283	BA2213
DF4497	BAR25124	GDB1121	BA2032	GDB1287	BA2154
DF4542	BAR28140	GDB1123	BA2163	GDB1288	BA2239
DF4546	BAR11151	GDB1126	BA2249	GDB1289	BA2250

# Vergleichsliste

Liste des correspondances / Tabella di conversione codici / Lista de comparação /



Lista porównawcza numerów / Porovnávací seznam čísel

LUCAS (TRW)		LUCAS (TRW)		LUCAS (TRW)	
GDB1290	BA2143	GDB1388	BA2253	GDB1488	BA2172
GDB1291	BA2142	GDB1389	BA2279	GDB149	BA2082
GDB1292	BA2176	GDB1391	BA2201	GDB1491	BA2278
GDB1293	BA2176	GDB1396	BA2271	GDB1492	BA2236
GDB1294	BA2018	GDB1397	BA2155	GDB1495	BA2282
GDB1297	BA2065	GDB1399	BA2216	GDB1498	BA2245
GDB1299	BA2072	GDB140	BA2041	GDB1500	BA2089
GDB1300	BA2137	GDB1402	BA2090	GDB1503	BA2285
GDB1302	BA2095	GDB1403	BA2205	GDB1504	BA2017
GDB1304	BA2167	GDB1404	BA2169	GDB1509	BA2225
GDB1306	BA2153	GDB1404	BA2190	GDB1514	BA2177
GDB1307	BA2172	GDB1405	BA2219	GDB1515	BA2194
GDB1310	BA2052	GDB1406	BA2244	GDB1517	BA2241
GDB1311	BA2017	GDB1407	BA2086	GDB1518	BA2323
GDB1312	BA2018	GDB1408	BA2290	GDB1520	BA2271
GDB1313	BA2237	GDB1411	BA2210	GDB1521	BA2324
GDB1314	BA2226	GDB1413	BA2177	GDB1524	BA2230
GDB1317	BA2268	GDB1415	BA2228	GDB1525	BA2225
GDB1321	BA2090	GDB1418	BA2203	GDB1527	BA2167
GDB1322	BA2151	GDB1419	BA2199	GDB1528	BA2246
GDB1324	BA2202	GDB1420	BA2260	GDB1530	BA2167
GDB1325	BA2202	GDB1421	BA2206	GDB1531	BA2190
GDB1326	BA2200	GDB1422	BA2155	GDB1538	BA2231
GDB1328	BA2017	GDB1425	BA2325	GDB1542	BA2221
GDB1330	BA2017	GDB1429	BA2244	GDB1543	BA2204
GDB1331	BA2162	GDB1430	BA2053	GDB1545	BA2164
GDB1332	BA2023	GDB1433	BA2220	GDB1546	BA2218
GDB1334	BA2206	GDB1434	BA2224	GDB1550	BA2195
GDB1335	BA2164	GDB1435	BA2225	GDB1551	BA2196
GDB1339	BA2332	GDB1437	BA2018	GDB1552	BA2230
GDB1343	BA2053	GDB1440	BA2269	GDB1554	BA2259
GDB1344	BA2053	GDB1442	BA2251	GDB1555	BA2242
GDB1346	BA2095	GDB1443	BA2334	GDB1556	BA2242
GDB1348	BA2108	GDB1445	BA2315	GDB1557	BA2243
GDB1349	BA2084	GDB1454	BA2184	GDB1559	BA2252
GDB1350	BA2211	GDB1460	BA2318	GDB1560	BA2240
GDB1351	BA2173	GDB1461	BA2262	GDB1561	BA2272
GDB1352	BA2197	GDB1462	BA2214	GDB1562	BA2255
GDB1354	BA2208	GDB1463	BA2214	GDB1563	BA2214
GDB1357	BA2154	GDB1464	BA2229	GDB1570	BA2210
GDB1358	BA2209	GDB1464	BA2289	GDB1572	BA2081
GDB1360	BA2212	GDB1465	BA2023	GDB1573	BA2080
GDB1361	BA2089	GDB1466	BA2254	GDB1574	BA2254
GDB1365	BA2217	GDB1467	BA2212	GDB1578	BA2017
GDB1366	BA2198	GDB1468	BA2288	GDB1580	BA2276
GDB1367	BA2321	GDB1469	BA2238	GDB1581	BA2286
GDB1369	BA2200	GDB1470	BA2261	GDB1582	BA2214
GDB1369	BA2202	GDB1471	BA2197	GDB1583	BA2234
GDB1372	BA2017	GDB1472	BA2298	GDB1584	BA2268
GDB1373	BA2091	GDB1476	BA2267	GDB1587	BA2017
GDB1376	BA2148	GDB1477	BA2272	GDB1588	BA2334
GDB1378	BA2191	GDB1478	BA2254	GDB1591	BA2289
GDB1379	BA2192	GDB1479	BA2247	GDB1597	BA2230
GDB1380	BA2320	GDB1481	BA2220	GDB1600	BA2263
GDB1386	BA2155	GDB1483	BA2299	GDB1601	BA2264
GDB1387	BA2143	GDB1485	BA2303	GDB1604	BA2271

# Vergleichsliste

Liste des correspondances / Tabella di conversione codici / Lista de comparação /



Lista porównawcza numerów / Porovnávací seznam čísel

LUCAS (TRW)		LUCAS (TRW)		LUCAS (TRW)	
GDB1605	BA2154	GDB1750	BA2289	GDB3304	BA2118
GDB1611	BA2307	GDB199	BA2134	GDB3311	BA2257
GDB1612	BA2308	GDB238	BA2144	GDB3317	BA2294
GDB1613	BA2236	GDB242	BA2109	GDB3331	BA2292
GDB1614	BA2284	GDB255	BA2144	GDB3332	BA2284
GDB1617	BA2259	GDB261	BA2193	GDB3336	BA2295
GDB1620	BA2300	GDB294	BA2093	GDB3337	BA2326
GDB1621	BA2235	GDB297	BA2064	GDB3363	BA2260
GDB1621	BA2258	GDB297	BA2065	GDB3387	BA2291
GDB1622	BA2196	GDB298	BA2188	GDB3389	BA2237
GDB1623	BA2214	GDB299	BA2189	GDB3396	BA2301
GDB1624	BA2229	GDB300	BA2126	GDB3432	BA2291
GDB1625	BA2311	GDB3092	BA2227	GDB344	BA2086
GDB1626	BA2309	GDB3116	BA2137	GDB373	BA2111
GDB1628	BA2310	GDB313	BA2056	GDB399	BA2025
GDB1629	BA2266	GDB3133	BA2117	GDB400	BA2023
GDB1630	BA2266	GDB3147	BA2116	GDB404	BA2028
GDB1633	BA2296	GDB3154	BA2280	GDB404	BA2031
GDB1634	BA2023	GDB3159	BA2273	GDB4084	BA2276
GDB1635	BA2023	GDB3161	BA2114	GDB425	BA2050
GDB1646	BA2271	GDB3168	BA2273	GDB430	BA2178
GDB1654	BA2283	GDB317	BA2101	GDB443	BA2019
GDB1657	BA2236	GDB3171	BA2122	GDB446	BA2036
GDB1658	BA2155	GDB3175	BA2280	GDB454	BA2132
GDB1659	BA2259	GDB3176	BA2274	GDB458	BA2034
GDB1665	BA2287	GDB3178	BA2144	GDB459	BA2133
GDB1668	BA2255	GDB3184	BA2121	GDB463	BA2131
GDB1669	BA2229	GDB3186	BA2278	GDB466	BA2035
GDB1671	BA2327	GDB3191	BA2280	GDB469	BA2040
GDB1676	BA2229	GDB3194	BA2257	GDB472	BA2030
GDB1677	BA2214	GDB3195	BA2123	GDB473	BA2039
GDB1678	BA2300	GDB3200	BA2249	GDB481	BA2124
GDB1681	BA2275	GDB3206	BA2115	GDB496	BA2010
GDB1682	BA2265	GDB3207	BA2116	GDB497	BA2012
GDB1683	BA2314	GDB3209	BA2118	GDB5050	BA2124
GDB1686	BA2236	GDB3212	BA2274	GDB585	BA2019
GDB1687	BA2317	GDB3216	BA2122	GDB654	BA2185
GDB1695	BA2124	GDB3227	BA2278	GDB695	BA2024
GDB1697	BA2277	GDB323	BA2121	GDB7075	BA2294
GDB1698	BA2281	GDB3231	BA2257	GDB729	BA2112
GDB1700	BA2256	GDB3242	BA2294	GDB764	BA2111
GDB1702	BA2166	GDB3243	BA2293	GDB7691	BA2301
GDB1703	BA2328	GDB3252	BA2115	GDB7734	BA2258
GDB1704	BA2265	GDB3258	BA2291	GDB774	BA2280
GDB1717	BA2207	GDB3267	BA2010	GDB788	BA2036
GDB1718	BA2329	GDB327	BA2055	GDB790	BA2020
GDB1719	BA2329	GDB328	BA2075	GDB791	BA2322
GDB1723	BA2305	GDB328	BA2077	GDB792	BA2050
GDB1724	BA2306	GDB3282	BA2291	GDB793	BA2043
GDB1725	BA2304	GDB3284	BA2291	GDB794	BA2096
GDB1727	BA2240	GDB3288	BA2270	GDB808	BA2036
GDB1732	BA2313	GDB3289	BA2331	GDB809	BA2023
GDB1740	BA2330	GDB3291	BA2278	GDB812	BA2014
GDB1741	BA2275	GDB3292	BA2238	GDB817	BA2027
GDB1745	BA2302	GDB3298	BA2291	GDB817	BA2093
GDB1749	BA2335	GDB3300	BA2116	GDB818	BA2029

# Vergleichsliste

Liste des correspondances / Tabella di conversione codici / Lista de comparação /



Lista porównawcza numerów / Porovnávací seznam čísel

LUCAS (TRW)		LUCAS (TRW)		LUCAS (TRW)	
GDB820	BA2026	GIC161	BAV1030	GS8582	BAE5027
GDB823	BA2032	GIC162	BAV1008	GS8605	BAE5002
GDB826	BA2038	GIC165	BAV1004	GS8607	BAE5015
GDB833	BA2033	GIC168	BAV1012	GS8609	BAE5004
GDB837	BA2181	GIC169	BAV1013	GS8611	BAE5004
GDB850	BA2026	GIC171	BAV1014	GS8613	BAE5019
GDB852	BA2033	GIC172	BAV1023	GS8616	BAE5022
GDB854	BA2031	GIC172	BAV1046	GS8627	BAE5007
GDB859	BA2011	GIC175	BAV1021	GS8629	BAE5034
GDB870	BA2114	GIC176	BAV1019	GS8635	BAE5019
GDB892	BA2114	GIC177	BAV1018	GS8636	BAE5041
GDB893	BA2292	GIC178	BAV1015	GS8637	BAE5012
GDB897	BA2084	GIC184	BAV1046	GS8639	BAE5009
GDB903	BA2060	GIC185	BAV1038	GS8650	BAE5017
GDB905	BA2076	GIC186	BAV1039	GS8653	BAE5029
GDB906	BA2096	GIC187	BAV1025	GS8654	BAE5038
GDB910	BA2162	GIC188	BAV1040	GS8687	BAE5010
GDB911	BA2094	GIC189	BAV1020	GS8689	BAE5018
GDB915	BA2095	GIC190	BAV1037	GS8690	BAE5028
GDB916	BA2125	GIC192	BAV1022	PHA106	BAH0015
GDB917	BA2054	GIC193	BAV1052	PHA119	BAH0011
GDB950	BA2068	GIC194	BAV1053	PHA246	BAH0015
GDB951	BA2137	GIC198	BAV1023	PHA262	BAH0014
GDB952	BA2098	GIC199	BAV1054	PHA270	BAH0024
GDB953	BA2146	GIC200	BAV1047	PHA288	BAH0012
GDB957	BA2175	GIC202	BAV1024	PHA289	BAH0026
GDB962	BA2182	GIC207	BAV1043	PHA292	BAH0016
GDB968	BA2023	GIC209	BAV1041	PHA294	BAH0013
GDB981	BA2110	GIC210	BAV1042	PHA341	BAH0033
GDB985	BA2099	GIC211	BAV1026	PHA343	BAH0022
GDB986	BA2106	GIC247	BAV1044	PHA455	BAH0022
GDB987	BA2161	GS8113	BAE5006	PHA490	BAH0021
GIC101	BAV1002	GS8166	BAE5003	PHB111	BAH0008
GIC102	BAV1007	GS8181	BAE5035	PHB113	BAH0010
GIC103	BAV1035	GS8211	BAE5008	PHB125	BAH0006
GIC104	BAV1001	GS8271	BAE5014	PHB128	BAH0003
GIC105	BAV1004	GS8279	BAE5021	PHB136	BAH0009
GIC108	BAV1035	GS8322	BAE5020	PHB251	BAH0001
GIC109	BAV1003	GS8453	BAE5039	PHB255	BAH0005
GIC110	BAV1003	GS8454	BAE5036	PHB320	BAH0028
GIC111	BAV1006	GS8472	BAE5032	PHB346	BAH0007
GIC112	BAV1005	GS8526	BAE5001	PHB348	BAH0025
GIC116	BAV1036	GS8528	BAE5013	PHB353	BAH0018
GIC118	BAV1031	GS8530	BAE5024	PHB410	BAH0006
GIC120	BAV1004	GS8534	BAE5002	PHB411	BAH0031
GIC122	BAV1004	GS8536	BAE5030	PHB426	BAH0017
GIC123	BAV1032	GS8537	BAE5031	PHB440	BAH0027
GIC125	BAV1028	GS8542	BAE5005	PHB447	BAH0006
GIC128	BAV1029	GS8543	BAE5011	PHB478	BAH0020
GIC133	BAV1027	GS8543	BAE5025	PHC105	BAH0032
GIC134	BAV1049	GS8544	BAE5006	PHC207	BAH0030
GIC135	BAV1017	GS8545	BAE5023	PHC208	BAH0032
GIC157	BAV1011	GS8546	BAE5042	PHC220	BAH0004
GIC158	BAV1009	GS8563	BAE5037	PHC280	BAH0029
GIC159	BAV1010	GS8567	BAE5026	PHD308	BAH0019
GIC160	BAV1016	GS8570	BAE5016	PHD349	BAH0023

# Vergleichsliste

Liste des correspondances / Tabella di conversione codici / Lista de comparação /



Lista porównawcza numerów / Porovnávací seznam čísel

LUCAS (TRW) 		MAZDA 		MERCEDES BENZ 	
PHD397	<b>BAH0019</b>	CBY1-33-23ZF	<b>BA2118</b>	000 420 57 20	<b>BA2162</b>
		CBY1-33-23ZG	<b>BA2118</b>	000 420 58 20	<b>BA2162</b>
<b>MAZDA</b>		CBY9-33-23Z	<b>BA2118</b>	000 420 71 20	<b>BA2162</b>
		DCY0-33-23ZA	<b>BA2115</b>	000 420 76 20	<b>BA2162</b>
1E00-26-38Z	<b>BAE5004</b>	DCY0-33-23ZB	<b>BA2115</b>	000 420 88 20	<b>BA2093</b>
1E01-26-38Z	<b>BAE5004</b>	DCY1-33-23Z	<b>BA2115</b>	000 420 89 20	<b>BA2027</b>
1E03-26-610	<b>BAW1702</b>	DCY5-33-23Z	<b>BA2115</b>	000 420 90 20	<b>BA2093</b>
1E03-33-23Z	<b>BA2146</b>	DCY9-33-23Z	<b>BA2115</b>	000 420 91 20	<b>BA2027</b>
1E03-33-23ZA	<b>BA2146</b>	DD32-33-25X	<b>BAR22172</b>	000 420 97 20	<b>BA2216</b>
1E03-33-23ZB	<b>BA2146</b>	DD59-33-25X	<b>BAR22172</b>	000 420 98 20	<b>BA2094</b>
1E03-33-251	<b>BAR12141</b>	DD63-33-25X	<b>BAR22172</b>	000 420 99 20	<b>BA2029</b>
1E03-33-251A	<b>BAR12141</b>	DD63-33-25XA	<b>BAR22172</b>	000 421 41 10	<b>BA2091</b>
1E04-26-610	<b>BAW1702</b>	DDY2-26-38Z	<b>BAE5036</b>	000 421 42 10	<b>BA2290</b>
1E04-26-610A	<b>BAW1914</b>	DDY2-26-710	<b>BAW1914</b>	000 421 61 10	<b>BA2263</b>
1E04-33-251	<b>BAR12141</b>	DDY2-26-710A	<b>BAW1914</b>	000 421 62 10	<b>BA2264</b>
1E06-26-610	<b>BAW1901</b>	DDY2-33-28Z	<b>BA2199</b>	000 423 02 30	<b>BA2218</b>
1E06-33-23Z	<b>BA2144</b>	G211-33-28Z	<b>BA2110</b>	000 428 35 35	<b>BAH0004</b>
1E06-33-23ZA	<b>BA2144</b>	G5Y6-33-23Z	<b>BA2118</b>	000 540 02 17	<b>BAV1004</b>
1E06-33-23ZB	<b>BA2144</b>	GA2Y-33-25X	<b>BAR24129</b>	000 586 22 42	<b>BA2162</b>
1E07-26-610	<b>BAW1901</b>	GA4Y-33-25X	<b>BAR24129</b>	000 586 25 42	<b>BA2162</b>
1E07-33-23Z	<b>BA2199</b>	GA4Y-33-25XC	<b>BAR24129</b>	000 586 41 42	<b>BA2162</b>
1E07-33-23ZA	<b>BA2199</b>	GA4Y-33-25XD	<b>BAR24129</b>	000 586 76 42	<b>BA2162</b>
1E10-33-23Z	<b>BA2199</b>	GA4Y-33-25XH	<b>BAR24129</b>	001 420 01 20	<b>BA2093</b>
1E12-33-23Z	<b>BA2203</b>	GA4Y-33-25XJ	<b>BAR24129</b>	001 420 02 20	<b>BA2161</b>
B455-33-292	<b>BA2115</b>	GA5Y-33-25X	<b>BAR24129</b>	001 420 06 20	<b>BA2162</b>
B4Y6-33-23Z	<b>BA2115</b>	GA5Y-33-25XD	<b>BAR24129</b>	001 420 07 20	<b>BA2029</b>
B4Y6-33-23ZA	<b>BA2115</b>	GAYR-33-23ZA	<b>BA2118</b>	001 420 10 20	<b>BA2027</b>
B5Y6-26-38Z	<b>BAE5027</b>	GBYH-33-23Z	<b>BA2118</b>	001 420 13 20	<b>BA2161</b>
B5Y6-26-38ZA	<b>BAE5027</b>	GCYD-33-23Z	<b>BA2118</b>	001 420 14 20	<b>BA2101</b>
B5Y6-33-23Z	<b>BA2115</b>	GEYC-26-43Z	<b>BA2257</b>	001 420 15 20	<b>BA2124</b>
B5Y6-33-28Z	<b>BA2115</b>	GEYC-26-43ZA	<b>BA2257</b>	001 420 79 20	<b>BA2162</b>
B5Y8-33-23Z	<b>BA2115</b>	GEYC-26-48Z	<b>BA2257</b>	001 420 81 20	<b>BA2027</b>
B5Y8-33-23ZA	<b>BA2115</b>	GEYC-26-48ZA	<b>BA2257</b>	001 420 93 20	<b>BA2162</b>
BCYC-33-23Z	<b>BA2115</b>	GEYC-33-23Z	<b>BA2118</b>	001 420 95 20	<b>BA2161</b>
BCYD-26-38Z	<b>BAE5027</b>	GEYT-26-43Z	<b>BA2257</b>	001 420 96 20	<b>BA2027</b>
BCYD-26-38ZA	<b>BAE5027</b>	GEYT-33-23Z	<b>BA2118</b>	001 420 98 20	<b>BA2182</b>
BCYW-33-23Z	<b>BA2115</b>	GEYV-33-23Z	<b>BA2118</b>	001 421 09 10	<b>BA2263</b>
BCYW-33-23ZC	<b>BA2115</b>	GGYB-26-43Z	<b>BA2257</b>	001 421 10 10	<b>BA2264</b>
BJ1Y-33-25X	<b>BAR24164</b>	GGYB-26-48Z	<b>BA2257</b>	002 420 04 20	<b>BA2174</b>
BLYM-33-23Z	<b>BA2118</b>	GGYM-26-43Z	<b>BA2257</b>	002 420 05 20	<b>BA2163</b>
BPYK-26-48Z	<b>BA2258</b>	GGYM-26-48Z	<b>BA2257</b>	002 420 12 20	<b>BA2174</b>
BPYK-26-48ZA	<b>BA2258</b>	GGYM-26-48ZA 9C	<b>BA2257</b>	002 420 15 20	<b>BA2182</b>
BPYK-26-48ZA9C	<b>BA2258</b>	GJ21-33-28ZB	<b>BA2110</b>	002 420 16 20	<b>BA2163</b>
BPYK-26-48ZB	<b>BA2258</b>	GJY1-33-28Z	<b>BA2110</b>	002 420 21 20	<b>BA2044</b>
BPYK-33-23Z	<b>BA2234</b>	GJYA-26-43Z	<b>BA2257</b>	002 420 22 20	<b>BA2044</b>
BPYK-33-23ZA	<b>BA2234</b>	GJYA-26-48Z	<b>BA2257</b>	002 420 23 20	<b>BA2029</b>
BR70-33-25XA	<b>BAR22166</b>	GJYB-26-43Z	<b>BA2257</b>	002 420 26 20	<b>BA2174</b>
BR70-33-25XF	<b>BAR22166</b>	GJYB-26-48Z	<b>BA2257</b>	002 420 38 20	<b>BA2233</b>
BRY0-33-28Z	<b>BA2115</b>	GJYB-26-48ZA	<b>BA2257</b>	002 420 39 20	<b>BA2149</b>
C2Y3-33-23ZA	<b>BA2234</b>	GN51-33-23Z	<b>BA2110</b>	002 420 40 20	<b>BA2215</b>
CBY0-33-23Z	<b>BA2118</b>	GN51-33-28Z	<b>BA2110</b>	002 420 41 20	<b>BA2239</b>
CBY1-33-23ZA	<b>BA2118</b>	NA01-33-25X	<b>BAR18113</b>	002 420 42 20	<b>BA2239</b>
CBY1-33-23ZB	<b>BA2118</b>	NA01-33-25XA	<b>BAR18113</b>	002 420 44 20	<b>BA2150</b>
CBY1-33-23ZC	<b>BA2118</b>	NA01-33-25XC	<b>BAR18113</b>	002 420 45 20	<b>BA2168</b>
CBY1-33-23ZD	<b>BA2118</b>			002 420 46 20	<b>BA2163</b>
CBY1-33-23ZE	<b>BA2118</b>			002 420 48 20	<b>BA2250</b>

# Vergleichsliste

Liste des correspondances / Tabella di conversione codici / Lista de comparação /



Lista porównawcza numerów / Porovnávací seznam čísel

MERCEDES BENZ 		MERCEDES BENZ 		MERCEDES BENZ 	
002 420 50 20	BA2168	004 420 44 20	BA2218	168 420 14 20	BA2176
002 420 51 20	BA2213	004 420 55 20	BA2149	168 420 15 20	BA2176
002 420 52 20	BA2206	004 420 56 20	BA2233	168 421 01 12	BAR12144
002 420 56 20	BA2233	004 420 67 20	BA2281	168 421 02 12	BAR22168
002 420 57 20	BA2124	004 420 69 20	BA2277	168 421 08 12	BAR22168
002 420 60 20	BA2215	004 420 79 20	BA2221	168 423 02 12	BAR08111
002 420 69 20	BA2233	004 420 83 20	BA2281	168 428 03 35	BAH0006
002 420 71 20	BA2164	004 420 87 20	BA2221	169 420 01 20	BA2310
002 420 74 20	BA2164	004 420 90 20	BA2204	169 420 02 20	BA2266
002 420 96 20	BA2150	004 420 91 20	BA2164	169 420 03 20	BA2266
002 420 99 20	BA2149	005 420 03 20	BA2044	169 420 04 20	BA2220
002 586 47 42	BA2162	005 420 17 20	BA2161	169 420 07 20	BA2266
002 586 48 42	BA2162	005 420 19 20	BA2206	169 420 08 20	BA2310
003 420 00 20	BA2250	005 420 21 20	BA2281	169 420 09 20	BA2266
003 420 01 20	BA2091	005 420 52 20	BA2281	169 420 10 20	BA2266
003 420 02 20	BA2290	005 420 70 20	BA2281	169 420 11 20	BA2220
003 420 05 20	BA2184	006 420 12 20	BA2184	171 428 00 35	BAH0006
003 420 08 20	BA2184	115 420 00 72	BAR10185	201 421 08 12	BAR11137
003 420 15 20	BA2124	115 423 02 12	BAR10185	201 421 12 12	BAR11137
003 420 17 20	BA2239	115 423 04 12	BAR10185	201 423 09 12	BAR09118
003 420 18 20	BA2184	123 420 00 72	BAR13137	201 423 11 12	BAR09118
003 420 24 20	BA2216	123 421 00 12	BAR13137	201 423 12 12	BAR09118
003 420 25 20	BA2177	123 428 01 35	BAH0004	201 540 03 17	BAV1001
003 420 26 20	BA2177	123 428 06 35	BAH0009	202 420 01 48	BAH0028
003 420 27 20	BA2164	123 540 00 17	BAV1004	202 421 02 12	BAR12128
003 420 28 20	BA2206	124 421 13 12	BAR12117	202 421 07 12	BAR22132
003 420 29 20	BA2168	124 423 05 12	BAR09114	202 421 09 12	BAR22132
003 420 30 20	BA2163	126 421 04 12	BAR28102	202 423 00 12	BAR09120
003 420 42 20	BA2184	126 421 05 12	BAR28102	202 428 07 35	BAH0018
003 420 44 20	BA2124	126 423 00 12	BAR10185	202 540 07 17	BAV1047
003 420 45 20	BA2177	126 428 03 35	BAH0004	203 421 03 12	BAR25110
003 420 48 20	BA2163	126 540 20 17	BAV1004	203 421 05 12	BAR28106
003 420 49 20	BA2163	129 428 00 35	BAH0009	203 423 01 12	BAR09114
003 420 51 20	BA2218	140 540 12 17	BAV1004	204 428 01 35	BAH0018
003 420 52 20	BA2206	163 420 00 20	BA2191	204 428 04 35	BAH0018
003 420 58 20	BA2204	163 420 01 20	BA2192	210 421 07 12	BAR25110
003 420 59 20	BA2177	163 420 03 20	BA2191	210 421 12 12	BAR28106
003 420 60 20	BA2177	163 420 04 20	BA2192	210 421 15 12	BAR28106
003 420 64 20	BA2233	163 420 06 20	BA2184	210 421 22 12	BAR28106
003 420 65 20	BA2221	163 420 08 20	BA2184	210 421 24 12	BAR25110
003 420 77 20	BA2124	163 420 08 20 27	BA2184	210 421 25 12	BAR28106
003 420 77 20 10	BA2124	163 421 00 12	BAR26116	210 423 01 12	BAR09114
003 420 95 20	BA2177	163 421 02 12	BAR26116	210 423 03 12	BAR10217
003 420 99 20	BA2221	163 421 04 12	BAR26116	210 423 04 12	BAR09114
004 420 02 20	BA2150	163 540 15 17	BAV1024	210 423 05 12	BAR12149
004 420 03 20	BA2168	163 540 17 17	BAV1024	210 423 06 12	BAR10217
004 420 04 20	BA2184	168 420 00 20	BA2176	210 423 09 12	BAR09114
004 420 04 20 67	BA2184	168 420 01 18	BAW1706	210 423 10 12	BAR10217
004 420 05 20	BA2204	168 420 01 20	BA2176	210 428 00 35	BAH0006
004 420 05 20 67	BA2204	168 420 02 20	BAE5007	210 428 05 35	BAH0006
004 420 15 20	BA2239	168 420 03 18	BAW1706	211 421 07 12	BAR28141
004 420 16 20	BA2163	168 420 03 20	BAE5007	211 421 08 12	BAR28176
004 420 17 20	BA2164	168 420 04 20	BA2220	211 421 09 12	BAR28142
004 420 18 20	BA2215	168 420 07 20	BA2176	211 423 07 12	BAR10278
004 420 24 20	BA2239	168 420 12 20	BA2176	211 540 07 17	BAV1023
004 420 27 20	BA2215	168 420 13 20	BA2176	211 540 17 17	BAV1046

# Vergleichsliste

Liste des correspondances / Tabella di conversione codici / Lista de comparação /



Lista porównawcza numerów / Porovnávací seznam čísel

MERCEDES BENZ 		MG ROVER 		MITSUBISHI 	
220 421 08 12	BAR32115	SDB000880	BAR22206	MR129103	BA2249
220 421 25 12	BAR32115	SDB100940	BAR22206	MR129104	BA2249
220 540 06 17	BAV1046	SEM100020	BA2011	MR205584	BAR24136
220 540 07 17	BAV1046	SFP000040	BA2190	MR205585	BAR24136
414 420 01 20	BA2220	SFP000070	BA2278	MR235557	BA2268
460 420 00 20	BA2101	SFP000080	BA2280	MR249241	BA2268
460 540 06 17	BAV1032	SFP000370	BA2278	MR249356	BAR10229
601 420 00 72	BAR16100	SFP100520	BA2053	MR389541	BA2117
601 420 02 72	BAR16100			MR389546	BA2249
601 420 76 20	BA2101	<b>MINI</b>		MR389548	BA2249
601 420 87 20	BA2101			MR389549	BA2249
601 421 04 12	BAR16100	34 11 1 503 076	BA2267	MR389725	BAR24170
601 421 50 12	BAR16100	34 11 6 761 287	BA2267	MR407946	BA2268
601 421 51 12	BAR16100	34 11 6 765 446	BA2267	MR475331	BAR24170
601 586 00 42	BA2101	34 11 6 772 892	BA2307	MR527656	BA2237
631 420 01 20	BA2068	34 21 1 503 077	BA2272	MR569597	BA2249
631 420 03 20	BA2068	34 21 6 761 288	BA2272	MR913846	BAR10229
638 421 01 12	BAR22162	34 21 6 762 871	BA2272	MR955351	BA2237
638 423 01 12	BAR10228	34 21 9 804 739	BA2308	MR977117	BA2268
639 423 01 12	BAR10280	34 21 9 808 172	BA2308	MZ690007	BA2249
639 540 14 17	BAV1048	34 35 6 761 447	BAV1038	X3511002	BA2117
639 540 15 17	BAV1048	34 35 6 761 448	BAV1039	X3511003	BA2249
669 420 00 20	BA2124	34 35 6 773 017	BAV1044	X3511007	BA2268
669 420 01 20	BA2124	34 35 6 773 018	BAV1045	X3511010	BA2237
669 540 04 17	BAV1033	34 35 6 783 230	BAV1044	X3516005	BA2226
669 540 05 17	BAV1033	34 35 6 783 772	BAV1045		
669 540 06 17	BAV1033	34 35 6 789 329	BAV1044	<b>NISSAN</b>	
669 540 07 17	BAV1034	34 35 6 789 330	BAV1045	40206-00QAA	BAR21106
669 540 08 17	BAV1034			40206-00QAD	BAR28129
669 540 09 17	BAV1034	<b>MITSUBISHI</b>		40206-00QAE	BAR28132
670 420 28 20	BA2124			40206-00QAF	BAR28132
901 421 03 12	BAR22161	4605A068	BAR24192	40206-00QAG	BAR28132
901 423 04 12	BAR12142	4605A076	BAR10304	40206-00QAH	BAR28132
901 423 06 12	BAR12142	4605A492	BA2249	40206-00QAJ	BAR20125
901 423 08 12	BAR12142	4605A734	BA2268	40206-0F000	BAR26109
901 428 04 35	BAH0020	M620770	BA2226	40206-0F001	BAR26109
901 540 00 17	BAV1008	M818027	BAR24159	40206-31G00	BAR26109
901 540 01 17	BAV1008	M850976	BA2237	40206-31G01	BAR26109
901 540 02 17	BAV1026	M850978	BA2226	40206-3Y502	BAR28140
901 540 03 17	BAV1026	MB500813	BA2112	40206-3Y503	BAR28140
902 421 03 12	BAR22161	MB500816	BA2112	40206-4U101	BAR28140
902 421 04 12	BAR22161	MB500819	BA2112	40206-4U103	BAR28140
902 421 06 12	BAR22161	MB597721	BA2112	40206-4U107	BAR28140
902 421 07 12	BAR22161	MB668886	BAR24146	40206-58A00	BAR18107
902 421 09 12	BAR22161	MB699174	BA2117	40206-58A01	BAR18107
902 423 01 12	BAR16110	MB699266	BA2117	40206-5F001	BAR12137
902 423 03 12	BAR16110	MB699288	BAR10229	40206-5F003	BAR12137
902 423 04 12	BAR16110	MB858375	BA2117	40206-60Y01	BAR18107
902 423 05 12	BAR16110	MB858400	BA2249	40206-9C100	BAR26108
903 421 00 12	BAR22245	MB858583	BA2117	40206-9C101	BAR26108
903 421 01 12	BAR22245	MB895072	BA2117	41060-00QAD	BA2251
904 423 02 12	BAR22196	MB895250	BA2249	41060-00QAE	BA2254
904 423 03 12	BAR22196	MB950570	BAR24146	41060-00QAF	BA2090
905 420 00 20	BA2124	MN102611	BA2249	41060-00QAG	BA2090
		MN116923	BA2249	41060-2F525	BA2273
		MN125772	BA2226		

# Vergleichsliste

Liste des correspondances / Tabella di conversione codici / Lista de comparação /

Lista porównawcza numerów / Porovnávací seznam čísel



NISSAN		OPEL		OPEL	
41060-2F526	BA2273	16 05 005	BA2095	16 05 668	BA2134
41060-2F527	BA2273	16 05 006	BA2095	16 05 670	BA2134
41060-2X825	BA2119	16 05 009	BA2211	16 05 671	BA2134
41060-4U125	BA2278	16 05 025	BA2197	16 05 687	BA2095
41060-4U126	BA2278	16 05 026	BA2095	16 05 696	BA2134
41060-4U127	BA2278	16 05 031	BA2095	16 05 697	BA2134
41060-50Y94	BA2113	16 05 033	BA2175	16 05 704	BA2134
41060-5M325	BA2273	16 05 034	BA2173	16 05 728	BA2098
41060-5M326	BA2273	16 05 035	BA2211	16 05 746	BA2137
41060-62C90	BA2113	16 05 036	BA2207	16 05 782	BA2175
41060-63C90	BA2113	16 05 039	BA2197	16 05 788	BA2134
41060-63Y90	BA2113	16 05 042	BAE5025	16 05 789	BA2137
41060-6F625	BA2232	16 05 047	BA2095	16 05 795	BA2134
41060-6F626	BA2232	16 05 056	BAE5011	16 05 799	BA2095
41060-99B25	BA2232	16 05 064	BAE5033	16 05 808	BA2137
41060-99B26	BA2232	16 05 065	BA2258	16 05 810	BA2136
41060-9C125	BA2119	16 05 070	BA2173	16 05 811	BAE5005
41060-9C525	BA2119	16 05 080	BA2255	16 05 812	BAE5011
41060-9C526	BA2119	16 05 081	BA2210	16 05 824	BA2136
41060-AV125	BA2278	16 05 086	BA2194	16 05 825	BA2114
41060-AV126	BA2278	16 05 091	BA2194	16 05 870	BA2134
41060-AX625	BA2284	16 05 093	BA2197	16 05 877	BA2098
41060-BF625	BA2232	16 05 094	BA2236	16 05 879	BA2095
41060-BM525	BA2273	16 05 095	BA2236	16 05 881	BA2136
43206-4U101	BAR10285	16 05 098	BA2236	16 05 883	BA2095
43206-4U103	BAR10285	16 05 099	BA2255	16 05 907	BA2136
43206-99J00	BAR10215	16 05 105	BA2197	16 05 910	BAE5011
43206-99J01	BAR10215	16 05 113	BA2236	16 05 911	BA2137
44060-00QAE	BA2261	16 05 117	BA2235	16 05 912	BA2207
44060-00QAF	BA2247	16 05 121	BA2194	16 05 916	BA2114
44060-00QAG	BAE5017	16 05 136	BA2236	16 05 920	BAE5012
44060-3F025	BA2227	16 05 137	BA2236	16 05 924	BA2095
44060-3F085	BA2227	16 05 139	BA2236	16 05 931	BA2114
44060-70J26	BA2227	16 05 196	BA2258	16 05 932	BA2175
44060-AV625	BA2238	16 05 198	BA2254	16 05 952	BAE5005
44060-AV725	BA2238	16 05 199	BA2247	16 05 953	BAE5011
44060-BA00F	BA2238	16 05 252	BA2255	16 05 957	BA2211
44060-BM425	BA2227	16 05 282	BA2236	16 05 959	BA2173
44060-BM426	BA2227	16 05 283	BA2236	16 05 961	BA2197
44100-00QAC	BAW2207	16 05 353	BA2256	16 05 964	BA2210
44100-0X810	BAW2010	16 05 359	BA2256	16 05 966	BA2207
44100-5F600	BAW1703	16 05 454	BA2137	16 05 967	BA2194
44100-6F611	BAW1703	16 05 455	BA2136	16 05 969	BAE5033
44100-99B12	BAW1703	16 05 456	BA2255	16 05 972	BA2236
D1060-AX60A	BA2284	16 05 463	BA2134	16 05 973	BA2235
		16 05 485	BA2134	16 05 974	BA2210
		16 05 496	BA2134	16 05 976	BA2260
		16 05 504	BA2134	16 05 979	BA2320
12 38 348	BAV1028	16 05 536	BA2134	16 05 980	BA2251
12 38 403	BAV1029	16 05 544	BA2134	16 05 982	BA2261
12 38 442	BAV1014	16 05 546	BA2134	16 05 992	BA2255
12 38 984	BAV1027	16 05 562	BA2134	16 05 993	BA2235
13122323	BAV1014	16 05 563	BA2134	16 05 995	BA2194
13322091	BA2258	16 05 582	BA2134	16 05 996	BA2255
16 05 000	BA2173	16 05 586	BA2134	16 05 997	BA2255
16 05 004	BA2175	16 05 625	BA2194	16 05 998	BA2255



# Vergleichsliste

Liste des correspondances / Tabella di conversione codici / Lista de comparação /



Lista porównawcza numerów / Porovnávací seznam čísel

OPEL		OPEL		OPEL	
24427919	BAV1020	5 69 111	BAR10251	90443902	BA2134
3487287	BA2134	5 69 115	BAR12157	90444513	BAR12131
3487299	BA2134	5 69 206	BAR10204	90485136	BA2098
44 02 993	BA2251	5 69 208	BAR12131	90485138	BA2095
44 03 038	BAR28129	5 69 209	BAR10225	90485140	BA2136
44 03 271	BA2086	5 69 210	BAR10226	90487271	BA2095
44 03 272	BA2086	62 38 230	BAV1020	90487402	BAR24115
44 03 283	BAR24103	62 38 322	BAV1049	90495144	BAV1017
44 03 467	BA2261	62 38 323	BAV1017	90495145	BAV1049
44 04 585	BA2251	62 38 388	BAV1016	90497051	BAV1016
44 08 275	BAR28132	62 38 389	BAV1030	90497052	BAV1030
44 14 021	BA2254	90008003	BAR10152	90510331	BA2136
44 14 029	BA2247	90008005	BAR13161	90511111	BAR20115
44 14 519	BA2254	90008006	BAR20115	90511162	BA2137
44 14 520	BA2247	90008029	BAR10152	90512029	BAR25119
44 14 632	BAR28132	90008031	BAR13161	90512037	BA2207
45 00 098	BAR24162	90008032	BAR20115	90512792	BAE5012
45 01 150	BA2320	90009592	BAW1705	90512909	BAR10225
45 02 797	BA2320	90009594	BAW1904	90512910	BAR10226
47 04 578	BA2260	90010584	BA2134	90540177	BA2095
47 06 748	BA2260	90010585	BA2134	90541257	BA2114
47 06 835	BA2260	90086193	BAR10152	90541293	BA2175
47 08 239	BA2301	90114901	BA2134	90542862	BAE5005
47 11 040	BA2301	90166278	BA2134	90542863	BAE5011
5 50 133	BAW1904	90167334	BA2134	90544001	BA2211
5 50 135	BAW1705	90167765	BA2134	90544025	BA2173
5 50 140	BAW1705	90235420	BAW1705	9110993	BA2251
5 50 141	BAW1904	90235422	BAW1904	9111038	BAR28129
5 50 143	BAW1705	90271134	BAR24111	9111271	BA2086
5 50 144	BAW1904	90272328	BAR10191	9111272	BA2086
5 69 000	BAR24166	90273260	BA2095	9111283	BAR24103
5 69 001	BAR24115	90295087	BAR24115	9111467	BA2261
5 69 003	BAR25141	90295577	BA2134	9112585	BA2251
5 69 006	BAR25148	90295578	BA2134	91149506	BAE5011
5 69 017	BAR10152	90297358	BA2134	91158366	BAE5011
5 69 020	BAR11152	90297537	BA2098	91159915	BAR28132
5 69 020	BAR13161	90297770	BA2137	91165426	BAR28132
5 69 021	BAR20174	90297932	BAR10205	9117677	BAR24152
5 69 022	BAR12184	90305792	BAV1029	9117678	BAR25131
5 69 028	BAR10152	90335784	BAV1028	9117717	BA2197
5 69 030	BAR13161	90374075	BAW1705	9117771	BAR10251
5 69 031	BAR20115	90374076	BAW1904	9117772	BAR10250
5 69 039	BAR24111	90392559	BAR28104	9160398	BAR24162
5 69 042	BAR24115	90398116	BA2175	9161450	BA2320
5 69 044	BAR28104	90398759	BA2134	9162600	BA2320
5 69 054	BAR20115	90398760	BA2137	9192124	BA2175
5 69 056	BAR25119	90399437	BA2134	9192125	BA2095
5 69 059	BAR24152	90399495	BA2137	9192126	BA2095
5 69 060	BAR25131	90421528	BA2095	9192157	BA2211
5 69 061	BAR25142	90421736	BA2136	9193251	BA2197
5 69 066	BAR25131	90421796	BAE5005	9193476	BA2095
5 69 100	BAR20171	90421797	BAE5011	9194477	BAR25142
5 69 101	BAR10191	90421872	BAR10204	9194893	BA2260
5 69 102	BAR10205	90425491	BAV1027	9195052	BAR20171
5 69 108	BAR10251	90442995	BA2136	9195058	BA2095
5 69 109	BAR10250	90443261	BAW1904	9195077	BA2175

# Vergleichsliste

Liste des correspondances / Tabella di conversione codici / Lista de comparação /



Lista porównawcza numerów / Porovnávací seznam čísel

OPEL		OPEL		PAGID	
9195144	BA2173	93188726	BA2194	50364	BAR22194
9195145	BA2211	93188916	BAR12184	50365	BAR26120
9195146	BA2207	93189698	BA2255	50366	BAR09137
9195607	BA2173	93189815	BA2256	50403	BAR13167
9195641	BA2197	93190338	BA2258	50410	BAR12124
9195685	BA2197	93191698	BA2256	50412	BAR12126
9195981	BAR11152	93192063	BA2254	50413	BAR10202
9195985	BAR20174	93192389	BA2247	50416	BAR12132
9196050	BAR24166	93192578	BA2255	50421	BAR22122
9196292	BAE5025	93192962	BA2301	50422	BAR22103
9196587	BAR10251	93196814	BA2301	50423	BAR28101
9198598	BA2197	93197592	BAR25131	50424	BAR22115
9198688	BA2207	94483220	BA2114	50426	BAR30101
9199257	BA2254	97114300	BA2114	50433	BAR10211
9199262	BA2247			50436	BAR19107
9200108	BA2210	<b>PAGID</b>		50439	BAR22159
9201354	BA2095			50440	BAR10227
9214424	BA2260	50206	BAR26108	50441	BAR20154
9214835	BA2260	50212	BAR18124	50442	BAR10273
93166798	BA2236	50214	BAR22158	50448	BAR22160
93169143	BA2194	50251	BAR11151	50449	BAR19108
93170602	BA2194	50257	BAR24158	50608	BAR08107
93170618	BAE5033	50260	BAR09136	50610	BAR08106
93171035	BA2173	50263	BAR09124	50614	BAR09122
93171065	BAE5033	50269	BAR32115	50616	BAR18108
93171497	BAR25141	50274	BAR08111	50619	BAR26104
93171848	BAR12157	50281	BAR24159	50902	BAR16105
93172174	BA2236	50282	BAR26122	50910	BAR12127
93172190	BA2235	50283	BAR28123	50910PRO	BAR12127
93172261	BA2210	50286	BAR21106	50915	BAR20142
93173148	BA2260	50288	BAR24171	50916	BAR24127
93173155	BA2320	50289	BAR24158	50917	BAR24138
93173180	BA2251	50296	BAR24164	50936	BAR20155
93173182	BA2261	50299	BAR22206	51008	BAR10115
93173641	BA2254	50303	BAR24146	51012	BAR10196
93173646	BA2247	50305	BAR10259	51020	BAR24112
93175376	BAR25148	50309	BAR12142	51023	BAR20147
93175378	BA2236	50310	BAR25137	51024	BAR24131
93176114	BA2210	50311	BAR10261	51025	BAR24132
93176116	BA2235	50314	BAR22151	51026	BAR24120
93176118	BA2194	50315	BAR25113	51032	BAR24131
93176429	BA2255	50316	BAR30113	51033	BAR24132
93179164	BA2194	50317	BAR18137	51034	BAR12141
93179707	BA2255	50318	BAR25138	51040	BAR22172
93179708	BA2255	50319	BAR22209	51119	BAR21105
93181189	BA2255	50320	BAR30107	51201	BAR19109
93183140	BA2235	50322	BAR30109	51701	BAR11115
93183728	BA2236	50343	BAR28140	51703	BAR12125
93183729	BA2236	50345	BAR24161	51808	BAR22147
93184519	BA2194	50346	BAR12154	51811	BAR22197
93185751	BA2236	50347	BAR26115	52014	BAR22166
93185752	BA2236	50354	BAR24170	52015	BAR24129
93186003	BA2236	50358	BAR25142	52018	BAR18113
93186713	BA2255	50360	BAR24166	52101	BAR10185
93188111	BA2236	50362	BAR13161	52102	BAR11137
93188112	BA2236	50363	BAR20174	52103	BAR13137

# Vergleichsliste

Liste des correspondances / Tabella di conversione codici / Lista de comparação /



Lista porównawcza numerów / Porovnávací seznam čísel

PAGID		PAGID		PAGID	
52104	BAR16100	52820	BAR20125	54127	BAR10229
52105	BAR09118	52821	BAR20126	54150	BAR28136
52106	BAR09120	52822	BAR24103	54151	BAR28141
52107	BAR12117	52830	BAR21106	54152	BAR28176
52108	BAR12128	52831	BAR22148	54153	BAR28142
52109	BAR09114	52833	BAR24171	54154	BAR10278
52116	BAR28102	53203	BAR13182	54159	BAR28129
52118	BAR22132	53634	BAR25124	54160	BAR28132
52137	BAR25110	53901	BAR10151	54166	BAR24127
52139	BAR10217	53903	BAR13160	54167	BAR24138
52142	BAR12142	53906	BAR20114	54173	BAR10260
52143	BAR22161	53908	BAR12106	54187	BAR25141
52144	BAR16110	53909	BAR10178	54205	BAR25158
52148	BAR22162	53911	BAR10111	54207	BAR22210
52149	BAR10228	53912	BAR10203	54208	BAR25145
52151	BAR28106	53913	BAR13178	54210	BAR25171
52153	BAR09114	53917	BAR10261	54211	BAR12158
52153PRO	BAR09114	53923	BAR13166	54214	BAR22211
52154	BAR12144	53924	BAR10201	54225	BAR24181
52155	BAR22168	53925	BAR15105	54226	BAR30173
52156	BAR12149	53926	BAR18105	54227	BAR20183
52167	BAR26116	53930	BAR20123	54235	BAR10280
52169	BAR22196	53933	BAR22118	54246	BAR25148
52311	BAR10215	53934	BAR20128	54257	BAR10285
52315	BAR12137	53936	BAR24118	54261	BAR09138
52321	BAR26109	53937	BAR22100	54262	BAR09139
52325	BAR18107	53938	BAR22108	54315	BAR22161
52403	BAR10152	53940	BAR22139	54334	BAR20115
52404	BAR13161	53942	BAR25105	54348	BAR24192
52406	BAR10191	53944	BAR10210	54349	BAR10304
52408	BAR10204	53946	BAR10232	54375	BAR12142
52409	BAR10205	53947	BAR18106	54376	BAR16110
52412	BAR12131	53952	BAR10224	54389	BAR25124
52413	BAR20115	53953	BAR22151	54408	BAR12169
52414	BAR24111	53954	BAR22150	54413	BAR25162
52415	BAR24115	53955	BAR09123	59278	BAR22245
52423	BAR28104	53957	BAR18111	81003	BAW1401
52426	BAR25119	53958	BAR24128	81004	BAW1401
52427	BAR10225	53959	BAR12138	81005	BAW1501
52428	BAR10226	53960	BAR25113	81008	BAW1501
52430	BAR24152	53961	BAR22152	81013	BAW1702
52431	BAR25131	53962	BAR25115	81015	BAW1701
52432	BAR10251	53963	BAR25114	81026	BAW1705
52433	BAR10250	53964	BAR10223	81027	BAW1701
52436	BAR24162	53969	BAR10258	81035	BAW1901
52505	BAR10187	53971	BAR25123	81046	BAW1902
52511	BAR20133	53972	BAR22163	81050	BAW1904
52512	BAR20132	53974	BAR26115	81052	BAW1909
52514	BAR10230	53975	BAR13194	81053	BAW1910
52515	BAR13184	54001	BAR10189	81054	BAW1913
52516	BAR13185	54016	BAR26105	81055	BAW1912
52517	BAR24139	54018	BAR26102	81056	BAW1909
52518	BAR26106	54023	BAR24136	81057	BAW1910
52803	BAR12116	54054	BAR22161	81059	BAW1906
52804	BAR08104	54059	BAR25110	81065	BAW1905
52810	BAR10219	54060	BAR28106	81092	BAW2004

# Vergleichsliste

Liste des correspondances / Tabella di conversione codici / Lista de comparação /



Lista porównawcza numerów / Porovnávací seznam čísel

PAGID		PAGID		PAGID	
81100	BAW2002	H8545	BAE5014	P8018	BAV1049
81103	BAW2005	H8560	BAE5021	P8019	BAV1017
81104	BAW2006	H8670	BAE5008	P8022	BAV1016
81107	BAW2005	H8685	BAE5013	P8023	BAV1030
81108	BAW2006	H8705	BAE5024	P8024	BAV1009
81113	BAW2010	H8710	BAE5005	P8025	BAV1010
81116	BAW2003	H8715	BAE5011	P8026	BAV1011
81117	BAW2009	H8720	BAE5001	P8027	BAV1008
81125	BAW2007	H8755	BAE5006	P8030	BAV1051
81133	BAW2202	H8805	BAE5016	P8031	BAV1050
81135	BAW2203	H8810	BAE5030	P8033	BAV1012
81166	BAW2201	H8830	BAE5031	P8034	BAV1013
81178	BAW2301	H8855	BAE5027	P8035	BAV1046
81187	BAW2501	H8900	BAE5002	P8036	BAV1015
81190	BAW2500	H8905	BAE5026	P8042	BAV1018
81194	BAW2008	H8920	BAE5023	P8043	BAV1019
81205	BAW2205	H8925	BAE5042	P8044	BAV1021
81206	BAW1903	H8930	BAE5034	P8046	BAV1047
81207	BAW2001	H8945	BAE5012	P8049	BAV1020
84001	BAH0016	H8950	BAE5037	P8050	BAV1022
84008	BAH0003	H8985	BAE5009	P8051	BAV1037
84009	BAH0011	H9000	BAE5019	P8052	BAV1023
84013	BAH0015	H9005	BAE5004	P8058	BAV1024
84014	BAH0015	H9055	BAE5015	P8060	BAV1038
84076	BAH0026	H9080	BAE5029	P8061	BAV1039
84084	BAH0004	H9085	BAE5038	P8062	BAV1025
84089	BAH0012	H9110	BAE5022	P8063	BAV1040
84091	BAH0008	H9170	BAE5028	P8067	BAV1052
84093	BAH0030	H9195	BAE5020	P8068	BAV1053
84111	BAH0010	H9235	BAE5035	P8069	BAV1041
84126	BAH0014	H9250	BAE5030	P8070	BAV1042
84132	BAH0009	H9310	BAE5015	P8071	BAV1043
84163	BAH0032	H9320	BAE5041	P8095	BAV1044
84172	BAH0001	H9325	BAE5017	P8514	BAV1033
84177	BAH0005	H9330	BAE5007	P8517	BAV1054
84192	BAH0013	H9445	BAE5036	P8555	BAV1026
84193	BAH0024	H9450	BAE5040	T0044	BA2112
84197	BAH0028	H9485	BAE5025	T0052	BA2126
84198	BAH0018	H9525	BAE5018	T0053	BA2110
84199	BAH0006	H9570	BAE5010	T0063	BA2187
84239	BAH0020	H9590	BAE5039	T0085	BA2187
84241	BAH0019	H9595	BAE5033	T0210	BA2019
84248	BAH0023	H9635	BAE5032	T0211NA	BA2026
84249	BAH0033	P0211	BAV1002	T0213	BA2039
84272	BAH0006	P0229	BAV1001	T0221	BA2034
84273	BAH0025	P0412	BAV1035	T0221-ECO	BA2034
84274	BAH0031	P0413	BAV1007	T0229NA	BA2027
C2004	BA2124	P8002	BAV1003	T0262NA	BA2052
C3002	BA2068	P8006	BAV1028	T0290	BA2024
C3016	BA2277	P8006	BAV1029	T0302NA	BA2028
C4028	BA2239	P8011	BAV1004	T0311	BA2101
C4068	BA2239	P8012	BAV1004	T0311-ECO	BA2101
C6024	BA2281	P8013	BAV1005	T0318	BA2121
H1068	BAE5003	P8014	BAV1006	T0351	BA2132
H1176	BAE5020	P8015	BAV1027	T0352	BA2027
H8185	BAE5035	P8016	BAV1036	T0352-ECO	BA2027

# Vergleichsliste

Liste des correspondances / Tabella di conversione codici / Lista de comparação /



Lista porównawcza numerów / Porovnávací seznam čísel

PAGID		PAGID		PAGID	
T0353	BA2033	T1050-ECO	BA2163	T1165	BA2154
T0353-ECO	BA2033	T1061	BA2138	T1165-ECO	BA2154
T0354	BA2124	T1062	BA2139	T1167	BA2209
T0366	BA2292	T1065	BA2075	T1167-ECO	BA2209
T0375	BA2134	T1075	BA2140	T1168	BA2091
T0388	BA2141	T1078	BA2244	T1169	BA2290
T0388-ECO	BA2141	T1081	BA2138	T1170	BA2216
T0389	BA2081	T1082	BA2137	T1171	BA2191
T0390	BA2080	T1082-ECO	BA2137	T1172	BA2192
T0398	BA2117	T1085	BA2207	T1174	BA2184
T0412	BA2189	T1090	BA2096	T1176	BA2217
T0412-ECO	BA2189	T1090	BA2097	T1177	BA2108
T0413	BA2188	T1091	BA2150	T1177-ECO	BA2108
T0413-ECO	BA2188	T1091-ECO	BA2150	T1178	BA2053
T0456	BA2185	T1092	BA2168	T1184	BA2162
T0494	BA2193	T1092-ECO	BA2168	T1189	BA2253
T0616	BA2062	T1093	BA2148	T1190	BA2279
T0616-ECO	BA2062	T1093-ECO	BA2148	T1191	BA2095
T0624	BA2064	T1094	BA2152	T1192	BA2203
T0624	BA2065	T1094-ECO	BA2152	T1193	BA2199
T0624-ECO	BA2064	T1095	BA2143	T1194	BA2269
T0624-ECO	BA2065	T1097	BA2145	T1195	BA2318
T0628	BA2082	T1097-ECO	BA2145	T1196	BA2201
T0669	BA2086	T1098	BA2142	T1196-ECO	BA2201
T0671	BA2082	T1101	BA2154	T1198	BA2164
T0810	BA2041	T1103	BA2169	T1202	BA2190
T0841	BA2134	T1104	BA2170	T1206	BA2095
T0841-ECO	BA2134	T1106	BA2147	T1207	BA2053
T1004	BA2093	T1106-ECO	BA2147	T1208	BA2315
T1004-ECO	BA2093	T1107	BA2171	T1210	BA2224
T1010	BA2094	T1107-ECO	BA2171	T1211	BA2225
T1010-ECO	BA2094	T1110	BA2333	T1213	BA2288
T1014	BA2161	T1111	BA2149	T1215	BA2238
T1014-ECO	BA2161	T1113	BA2146	T1218	BA2246
T1016	BA2095	T1113-ECO	BA2146	T1220	BA2267
T1016-ECO	BA2095	T1117	BA2167	T1221	BA2272
T1018	BA2054	T1120	BA2167	T1223	BA2259
T1021	BA2137	T1124	BA2215	T1225	BA2255
T1022	BA2146	T1125	BA2250	T1229	BA2121
T1022-ECO	BA2146	T1136	BA2166	T1230	BA2245
T1026	BA2125	T1137	BA2151	T1234	BA2236
T1026-ECO	BA2125	T1138	BA2100	T1240	BA2271
T1027	BA2054	T1141	BA2144	T1245	BA2089
T1027-ECO	BA2054	T1141-ECO	BA2144	T1246	BA2261
T1034	BA2098	T1142	BA2233	T1248	BA2276
T1034-ECO	BA2098	T1143	BA2153	T1249	BA2286
T1035	BA2135	T1143-ECO	BA2153	T1252	BA2108
T1036	BA2182	T1145	BA2211	T1263	BA2280
T1037	BA2108	T1149	BA2172	T1266	BA2019
T1037-ECO	BA2108	T1151	BA2332	T1268	BA2118
T1038	BA2099	T1152	BA2206	T1302	BA2062
T1039	BA2053	T1153	BA2164	T1305	BA2291
T1045	BA2136	T1154	BA2205	T1310	BA2251
T1045-ECO	BA2136	T1163	BA2155	T1318	BA2204
T1049	BA2174	T1163-ECO	BA2155	T1324	BA2282
T1050	BA2163	T1164	BA2173	T1325	BA2184

# Vergleichsliste

Liste des correspondances / Tabella di conversione codici / Lista de comparação /



Lista porównawcza numerów / Porovnávací seznam čísel

PAGID		PAGID		PAGID	
T1345	BA2334	T1577	BA2212	T4150	BA2131
T1347	BA2176	T1579	BA2253	T4150-ECO	BA2131
T1348	BA2310	T1594	BA2301	T4151	BA2133
T1349	BA2040	T1609	BA2327	T4151-ECO	BA2133
T1351	BA2017	T1634	BA2090	T4154	BA2132
T1354	BA2241	T1640	BA2306	T4154-ECO	BA2132
T1355	BA2324	T1641	BA2305	T5005	BA2029
T1356	BA2323	T1642	BA2304	T5005-ECO	BA2029
T1366	BA2240	T1643	BA2212	T5006	BA2030
T1369	BA2285	T1644	BA2017	T5006-ECO	BA2030
T1373	BA2230	T1647	BA2256	T5008	BA2178
T1376	BA2195	T1648	BA2283	T5009	BA2028
T1377	BA2196	T1653	BA2314	T5009-ECO	BA2028
T1380	BA2231	T1655	BA2265	T5012	BA2025
T1382	BA2263	T1656	BA2328	T5021	BA2031
T1383	BA2264	T1657	BA2275	T5021-ECO	BA2031
T1387	BA2169	T1690	BA2316	T5022	BA2032
T1388	BA2172	T1693	BA2317	T5022-ECO	BA2032
T1390	BA2247	T1710	BA2330	T5025	BA2035
T1398	BA2331	T1772	BA2335	T5026	BA2040
T1399	BA2284	T1841	BA2154	T5027	BA2043
T1422	BA2214	T1852	BA2294	T5027-ECO	BA2043
T1424	BA2254	T2006	BA2020	T5030	BA2175
T1428	BA2257	T2006	BA2036	T5035	BA2026
T1432	BA2242	T2006-ECO	BA2020	T5035-ECO	BA2026
T1436	BA2234	T2006-ECO	BA2036	T5050	BA2037
T1444	BA2307	T2017	BA2036	T5050-ECO	BA2037
T1445	BA2308	T2017-ECO	BA2036	T5051	BA2038
T1446	BA2311	T3002	BA2118	T5051-ECO	BA2038
T1447	BA2309	T3003	BA2114	T5053	BA2014
T1448	BA2252	T3004	BA2113	T5054	BA2039
T1449	BA2289	T3013	BA2116	T5056	BA2052
T1450	BA2272	T3014	BA2115	T5056-ECO	BA2052
T1452	BA2266	T3017	BA2280	T5060	BA2048
T1453	BA2266	T3022	BA2232	T5062	BA2181
T1457	BA2242	T3024	BA2274	T5064	BA2227
T1468	BA2214	T3025	BA2249	T5065	BA2010
T1469	BA2243	T3037	BA2119	T5066	BA2322
T1486	BA2260	T3040	BA2268	T5067	BA2044
T1487	BA2259	T3052	BA2257	T5067-ECO	BA2044
T1489	BA2235	T3075	BA2110	T5072	BA2049
T1489	BA2258	T3093	BA2123	T5072-ECO	BA2049
T1491	BA2249	T3095	BA2237	T5073	BA2011
T1492	BA2196	T3099	BA2294	T5074	BA2020
T1496	BA2300	T3106	BA2122	T5075	BA2017
T1511	BA2278	T3111	BA2278	T5075-ECO	BA2017
T1530	BA2220	T3117	BA2293	T5077	BA2023
T1531	BA2296	T3120	BA2270	T5077-ECO	BA2023
T1534	BA2287	T3121	BA2260	T5078	BA2045
T1536	BA2276	T3129	BA2295	T5079	BA2046
T1537	BA2286	T3130	BA2326	T5080	BA2012
T1538	BA2225	T4017	BA2144	T5084	BA2047
T1557	BA2118	T4017-ECO	BA2144	T5089	BA2202
T1563	BA2167	T4114	BA2162	T5090	BA2015
T1564	BA2268	T4114-ECO	BA2162	T5092	BA2016
T1565	BA2237	T4141	BA2109	T5095	BA2018

# Vergleichsliste

Liste des correspondances / Tabella di conversione codici / Lista de comparação /



Lista porównawcza numerów / Porovnávací seznam čísel

PAGID		PAGID		PEUGEOT	
T5095-ECO	BA2018	T9028	BA2074	4246 L9	BAR24139
T5098	BA2160	T9029	BA2066	4246 N0	BAR26106
T5098-ECO	BA2160	T9029-ECO	BA2066	4246 P1	BAR28136
T5099	BA2021	T9030	BA2073	4246 R2	BAR13184
T5100	BA2226	T9031	BA2072	4246 R3	BAR20133
T5101	BA2176	T9032	BA2013	4246 R7	BAR26106
T5110	BA2176	T9033	BA2050	4246 R8	BAR13185
T5111	BA2177	T9037	BA2107	4246 T6	BAR10230
T5112	BA2177	T9038	BA2078	4246 T7	BAR10230
T5115	BA2322	T9054	BA2079	4246 W5	BAR20133
T5115-ECO	BA2322	T9057	BA2239	4246 W7	BAR22194
T5118	BA2208	T9062	BA2022	4246 W8	BAR26120
T5121	BA2273	T9066	BA2197	4246 W9	BAR09137
T5122	BA2198	T9069	BA2084	4246 X9	BAR24127
T5122-ECO	BA2198	T9069-ECO	BA2084	4246 Y5	BAR24138
T5127	BA2022	T9070	BA2090	4248 33	BA2024
T5128	BA2210	T9073	BA2089	4249 15	BAR22194
T5130	BA2220	T9075	BA2320	4249 17	BAR26120
T5134	BA2202	T9101	BA2219	4249 26	BAR24127
T5135	BA2200	T9107	BA2262	4249 35	BAR24138
T5136	BA2202			4249 52	BAR09137
T5136-ECO	BA2202	<b>PEUGEOT</b>		4249 73	BAR22197
T5137	BA2202			4249 83	BAR22194
T5138	BA2228	4241 21	BAE5020	4249 84	BAR26120
T5140	BA2321	4241 73	BAE5020	4249 90	BAR09137
T5154	BA2221	4241 E7	BAE5014	4249 95	BAR10187
T5155	BA2218	4241 E8	BAE5020	4249 96	BAR20132
T5158	BA2194	4241 H4	BAE5023	4249 99	BAR24127
T5161	BA2298	4241 H5	BAE5042	4249 A5	BAR13185
T5162	BA2283	4241 H7	BAE5037	4249 G1	BAR22194
T5163	BA2299	4241 J1	BAE5002	4249 H2	BAR24138
T5165	BA2303	4241 J5	BAE5002	4249 J6	BAR26120
T5166	BA2214	4241 J8	BAE5019	4249 K3	BAR24127
T5167	BA2229	4241 J9	BAE5020	4249 L1	BAR16105
T5170	BA2325	4241 K6	BAE5037	4249 L2	BAR22197
T6028	BA2056	4241 K8	BAE5019	4250 35	BA2055
T6064	BA2075	4241 L2	BAE5032	4250 37	BA2036
T6064	BA2077	4241 L3	BAE5020	4250 39	BA2036
T6064-ECO	BA2077	4241 N4	BAE5042	4250 43	BA2055
T6065	BA2076	4246 89	BAR10187	4250 50	BA2055
T6088	BA2055	4246 94	BAR20132	4250 51	BA2055
T6088	BA2066	4246 95	BAR16105	4250 54	BA2024
T6088-ECO	BA2055	4246 97	BAR20133	4250 55	BA2043
T6089	BA2060	4246 A5	BAR10187	4250 56	BA2032
T6089-ECO	BA2060	4246 A7	BAR20132	4250 69	BA2055
T6112	BA2050	4246 B1	BAR20133	4250 71	BA2076
T9000	BA2086	4246 B4	BAR16105	4250 72	BA2055
T9003	BA2064	4246 F8	BAR08107	4250 76	BA2055
T9003	BA2065	4246 G0	BAR08107	4250 82	BA2036
T9008	BA2106	4246 G6	BAR08106	4250 87	BA2043
T9012	BA2084	4246 H8	BAR20155	4250 88	BA2055
T9012-ECO	BA2084	4246 J2	BAR26104	4250 90	BA2097
T9021	BA2071	4246 J8	BAR18108	4250 91	BA2066
T9025	BA2068	4246 K2	BAR24138	4250 92	BA2066
T9026	BA2286	4246 L2	BAR24127	4250 95	BA2043
T9027	BA2276	4246 L7	BAR10230	4250 97	BA2055

# Vergleichsliste

Liste des correspondances / Tabella di conversione codici / Lista de comparação /

Lista porównawcza numerów / Porovnávací seznam čísel



PEUGEOT		PEUGEOT		PROTON	
4251 02	<b>BA2074</b>	4253 40	<b>BA2300</b>	MB858375	<b>BA2117</b>
4251 03	<b>BA2140</b>	4253 41	<b>BA2214</b>	MB895072	<b>BA2117</b>
4251 04	<b>BA2076</b>	4253 55	<b>BA2275</b>		
4251 06	<b>BA2024</b>	4253 57	<b>BA2275</b>	<b>RENAULT</b>	
4251 09	<b>BA2047</b>	4253 59	<b>BA2265</b>		
4251 16	<b>BA2045</b>	4253 63	<b>BA2329</b>	41 06 021 92R	<b>BA2023</b>
4251 18	<b>BA2046</b>	4253 65	<b>BA2329</b>	41 06 047 75R	<b>BA2284</b>
4251 20	<b>BA2066</b>	4253 67	<b>BA2330</b>	44 06 000 02R	<b>BA2235</b>
4251 21	<b>BA2140</b>	4253 73	<b>BA2328</b>	44 06 079 60R	<b>BA2212</b>
4251 22	<b>BA2140</b>	4253 85	<b>BA2229</b>	50 01 000 446	<b>BAW2501</b>
4251 30	<b>BA2099</b>	4253 87	<b>BA2249</b>	60 01 547 619	<b>BA2023</b>
4251 31	<b>BA2015</b>	4253 98	<b>BA2300</b>	60 01 547 630	<b>BAE5002</b>
4251 32	<b>BA2016</b>	4254 18	<b>BA2229</b>	60 01 547 632	<b>BAW1704</b>
4251 34	<b>BA2151</b>	4254 51	<b>BA2045</b>	60 01 547 683	<b>BAR12171</b>
4251 41	<b>BA2083</b>	4254 52	<b>BA2046</b>	60 01 547 684	<b>BAR12116</b>
4251 42	<b>BA2151</b>	4254 53	<b>BA2047</b>	60 01 547 911	<b>BA2023</b>
4251 43	<b>BA2016</b>	4254 54	<b>BA2079</b>	60 01 549 211	<b>BAR12116</b>
4251 48	<b>BA2076</b>	4254 55	<b>BA2325</b>	60 25 071 042	<b>BA2023</b>
4251 51	<b>BA2079</b>	4254 57	<b>BA2285</b>	60 25 170 170	<b>BA2013</b>
4251 54	<b>BA2021</b>	4254 58	<b>BA2241</b>	60 25 170 586	<b>BA2082</b>
4251 60	<b>BA2016</b>	4254 59	<b>BA2324</b>	60 25 170 860	<b>BA2082</b>
4251 64	<b>BA2100</b>	4254 61	<b>BA2275</b>	60 25 171 456	<b>BA2013</b>
4251 65	<b>BA2083</b>	4254 62	<b>BA2275</b>	60 25 304 079	<b>BAR11151</b>
4251 66	<b>BA2089</b>	4254 63	<b>BA2328</b>	60 25 308 186	<b>BA2107</b>
4251 67	<b>BA2151</b>	4254 67	<b>BA2017</b>	60 25 315 867	<b>BA2022</b>
4251 91	<b>BA2089</b>	4254 68	<b>BA2323</b>	60 25 370 398	<b>BA2022</b>
4251 96	<b>BA2076</b>	4254 69	<b>BA2265</b>	60 25 370 406	<b>BAR11151</b>
4252 04	<b>BA2089</b>	4254 71	<b>BA2229</b>	60 25 371 279	<b>BA2254</b>
4252 12	<b>BA2089</b>	4254 74	<b>BA2296</b>	60 25 371 650	<b>BA2212</b>
4252 20	<b>BA2285</b>	4254 75	<b>BA2214</b>	60 25 407 835	<b>BA2022</b>
4252 21	<b>BA2214</b>	4254 89	<b>BA2229</b>	77 00 302 128	<b>BAR24162</b>
4252 22	<b>BA2229</b>	4402 70	<b>BAW2501</b>	77 00 314 064	<b>BAR28129</b>
4252 23	<b>BA2017</b>	4402 90	<b>BAW1909</b>	77 00 561 367	<b>BAR24103</b>
4252 24	<b>BA2325</b>	4402 91	<b>BAW1910</b>	77 00 704 705	<b>BAR12116</b>
4252 28	<b>BA2089</b>	4402 93	<b>BAW1913</b>	77 00 715 081	<b>BAR20126</b>
4252 32	<b>BA2017</b>	4402 94	<b>BAW1912</b>	77 00 716 947	<b>BAR08104</b>
4252 38	<b>BA2214</b>	4402 A3	<b>BAW2600</b>	77 00 756 572	<b>BAR20125</b>
4252 39	<b>BA2214</b>	4402 A5	<b>BAW2800</b>	77 00 780 892	<b>BAR21106</b>
4252 42	<b>BA2241</b>	4402 A7	<b>BAW1906</b>	77 00 800 002	<b>BAR10219</b>
4252 44	<b>BA2324</b>	4402 A8	<b>BAW2001</b>	77 00 802 231	<b>BAR24171</b>
4252 46	<b>BA2323</b>	4402 C3	<b>BAW2001</b>	77 00 802 232	<b>BAR22148</b>
4252 50	<b>BA2229</b>	4402 C6	<b>BAW2205</b>	77 00 804 356	<b>BAH0024</b>
4252 52	<b>BA2229</b>	4402 E4	<b>BAW2600</b>	77 00 813 549	<b>BAR21106</b>
4252 56	<b>BA2076</b>	4806 92	<b>BAH0031</b>	77 00 824 736	<b>BAH0024</b>
4252 59	<b>BA2214</b>	4806 C1	<b>BAH0031</b>	77 00 830 283	<b>BAR24171</b>
4252 68	<b>BA2015</b>			77 00 841 563	<b>BAR22148</b>
4252 71	<b>BA2076</b>	<b>PORSCHE</b>		77 00 842 131	<b>BAR21106</b>
4252 76	<b>BA2214</b>			77 01 033 390	<b>BAW2005</b>
4253 02	<b>BA2089</b>	955 612 365 00	<b>BAV1052</b>	77 01 033 391	<b>BAW2006</b>
4253 14	<b>BA2074</b>	955 612 365 20	<b>BAV1053</b>	77 01 035 310	<b>BAW2006</b>
4253 19	<b>BA2089</b>	955 612 365 30	<b>BAV1053</b>	77 01 035 311	<b>BAW2005</b>
4253 20	<b>BA2089</b>	986 612 365 00	<b>BAV1051</b>	77 01 035 473	<b>BAW2005</b>
4253 22	<b>BA2300</b>	996 612 365 00	<b>BAV1050</b>	77 01 035 474	<b>BAW2006</b>
4253 27	<b>BA2296</b>			77 01 036 385	<b>BAW2005</b>
4253 38	<b>BA2214</b>			77 01 036 386	<b>BAW2006</b>
4253 39	<b>BA2229</b>			77 01 039 388	<b>BAW2005</b>



# Vergleichsliste

Liste des correspondances / Tabella di conversione codici / Lista de comparação /



Lista porównawcza numerów / Porovnávací seznam čísel

RENAULT		RENAULT		RENAULT	
77 01 039 389	<b>BAW2006</b>	77 01 203 070	<b>BA2050</b>	77 01 205 720	<b>BAE5002</b>
77 01 039 394	<b>BAW2005</b>	77 01 203 071	<b>BA2019</b>	77 01 205 840	<b>BAR22148</b>
77 01 039 395	<b>BAW2006</b>	77 01 203 124	<b>BA2107</b>	77 01 205 842	<b>BAR24158</b>
77 01 041 021	<b>BAW2001</b>	77 01 203 129	<b>BA2023</b>	77 01 205 843	<b>BAR24171</b>
77 01 043 912	<b>BAW2207</b>	77 01 203 282	<b>BA2023</b>	77 01 205 844	<b>BAR10219</b>
77 01 044 681	<b>BAW1704</b>	77 01 203 633	<b>BA2107</b>	77 01 205 995	<b>BA2090</b>
77 01 044 850	<b>BAW1907</b>	77 01 203 726	<b>BA2107</b>	77 01 205 996	<b>BA2090</b>
77 01 047 236	<b>BAW1908</b>	77 01 203 730	<b>BA2050</b>	77 01 206 082	<b>BA2023</b>
77 01 047 838	<b>BAW1707</b>	77 01 203 775	<b>BA2023</b>	77 01 206 118	<b>BAR24158</b>
77 01 050 914	<b>BA2254</b>	77 01 203 795	<b>BA2023</b>	77 01 206 198	<b>BAR24171</b>
77 01 050 918	<b>BA2247</b>	77 01 203 796	<b>BA2023</b>	77 01 206 288	<b>BA2050</b>
77 01 054 771	<b>BA2254</b>	77 01 203 797	<b>BA2023</b>	77 01 206 339	<b>BAR21106</b>
77 01 054 772	<b>BA2247</b>	77 01 203 842	<b>BA2075</b>	77 01 206 343	<b>BA2212</b>
77 01 070 668	<b>BAW1907</b>	77 01 203 913	<b>BA2086</b>	77 01 206 369	<b>BA2320</b>
77 01 200 360	<b>BA2082</b>	77 01 203 918	<b>BA2086</b>	77 01 206 379	<b>BA2219</b>
77 01 201 321	<b>BA2082</b>	77 01 203 919	<b>BA2076</b>	77 01 206 599	<b>BA2288</b>
77 01 201 542	<b>BA2055</b>	77 01 203 968	<b>BA2050</b>	77 01 206 609	<b>BA2238</b>
77 01 201 669	<b>BA2023</b>	77 01 203 979	<b>BAE5002</b>	77 01 206 727	<b>BA2251</b>
77 01 201 864	<b>BA2082</b>	77 01 204 066	<b>BA2023</b>	77 01 206 763	<b>BA2261</b>
77 01 202 050	<b>BA2050</b>	77 01 204 087	<b>BA2060</b>	77 01 206 784	<b>BA2212</b>
77 01 202 057	<b>BA2055</b>	77 01 204 220	<b>BA2050</b>	77 01 206 811	<b>BA2090</b>
77 01 202 148	<b>BA2082</b>	77 01 204 268	<b>BAE5008</b>	77 01 206 845	<b>BAR28132</b>
77 01 202 210	<b>BA2076</b>	77 01 204 281	<b>BAR24103</b>	77 01 206 962	<b>BAE5002</b>
77 01 202 213	<b>BA2077</b>	77 01 204 282	<b>BAR12116</b>	77 01 207 066	<b>BA2023</b>
77 01 202 227	<b>BA2077</b>	77 01 204 283	<b>BAR20126</b>	77 01 207 166	<b>BA2320</b>
77 01 202 283	<b>BA2055</b>	77 01 204 285	<b>BAR08104</b>	77 01 207 184	<b>BA2230</b>
77 01 202 284	<b>BA2023</b>	77 01 204 286	<b>BAR20125</b>	77 01 207 187	<b>BA2225</b>
77 01 202 285	<b>BA2023</b>	77 01 204 295	<b>BAR10219</b>	77 01 207 266	<b>BAE5022</b>
77 01 202 289	<b>BA2023</b>	77 01 204 304	<b>BAR21106</b>	77 01 207 339	<b>BA2251</b>
77 01 202 308	<b>BA2076</b>	77 01 204 305	<b>BAR24171</b>	77 01 207 484	<b>BA2212</b>
77 01 202 475	<b>BA2055</b>	77 01 204 357	<b>BA2023</b>	77 01 207 555	<b>BAE5017</b>
77 01 202 481	<b>BA2060</b>	77 01 204 358	<b>BA2023</b>	77 01 207 672	<b>BA2230</b>
77 01 202 516	<b>BA2023</b>	77 01 204 495	<b>BAR22148</b>	77 01 207 695	<b>BA2212</b>
77 01 202 517	<b>BA2077</b>	77 01 204 530	<b>BA2055</b>	77 01 207 829	<b>BAR24158</b>
77 01 202 518	<b>BA2055</b>	77 01 204 626	<b>BA2076</b>	77 01 207 960	<b>BA2023</b>
77 01 202 542	<b>BAE5008</b>	77 01 204 664	<b>BA2076</b>	77 01 207 996	<b>BA2238</b>
77 01 202 662	<b>BA2076</b>	77 01 204 708	<b>BA2055</b>	77 01 208 111	<b>BAE5002</b>
77 01 202 710	<b>BA2077</b>	77 01 204 828	<b>BAR21106</b>	77 01 208 122	<b>BA2230</b>
77 01 202 711	<b>BA2055</b>	77 01 204 833	<b>BA2023</b>	77 01 208 142	<b>BA2090</b>
77 01 202 712	<b>BA2023</b>	77 01 204 835	<b>BAE5022</b>	77 01 208 182	<b>BA2288</b>
77 01 202 713	<b>BA2086</b>	77 01 204 845	<b>BA2076</b>	77 01 208 213	<b>BA2212</b>
77 01 202 785	<b>BA2060</b>	77 01 204 883	<b>BAE5026</b>	77 01 208 252	<b>BAR12171</b>
77 01 202 788	<b>BA2082</b>	77 01 204 903	<b>BA2055</b>	77 01 208 265	<b>BA2023</b>
77 01 202 815	<b>BA2060</b>	77 01 205 015	<b>BA2107</b>	77 01 208 416	<b>BA2212</b>
77 01 202 820	<b>BAE5008</b>	77 01 205 085	<b>BAR22148</b>	77 01 208 421	<b>BA2212</b>
77 01 202 847	<b>BA2055</b>	77 01 205 086	<b>BAR24158</b>	77 01 208 422	<b>BA2284</b>
77 01 202 848	<b>BA2023</b>	77 01 205 228	<b>BAR22148</b>	77 01 209 100	<b>BA2317</b>
77 01 202 891	<b>BA2077</b>	77 01 205 230	<b>BAR24158</b>	77 01 209 101	<b>BA2316</b>
77 01 202 892	<b>BA2055</b>	77 01 205 231	<b>BAR24171</b>	77 01 209 164	<b>BA2284</b>
77 01 202 894	<b>BA2023</b>	77 01 205 277	<b>BA2075</b>	77 01 209 670	<b>BA2317</b>
77 01 202 895	<b>BA2023</b>	77 01 205 294	<b>BA2320</b>	77 01 209 735	<b>BA2212</b>
77 01 202 896	<b>BA2050</b>	77 01 205 339	<b>BAE5026</b>	77 01 209 809	<b>BA2288</b>
77 01 202 903	<b>BA2082</b>	77 01 205 355	<b>BA2023</b>	77 01 209 841	<b>BA2212</b>
77 01 202 973	<b>BA2050</b>	77 01 205 513	<b>BA2090</b>	77 01 210 142	<b>BA2023</b>
77 01 203 068	<b>BA2082</b>	77 01 205 523	<b>BAE5017</b>	77 01 348 689	<b>BA2082</b>
77 01 203 069	<b>BA2060</b>	77 01 205 653	<b>BAR21106</b>	77 01 349 255	<b>BA2019</b>

# Vergleichsliste

Liste des correspondances / Tabella di conversione codici / Lista de comparação /



Lista porównawcza numerów / Porovnávací seznam čísel

RENAULT		SAAB		SEAT	
77 01 349 751	<b>BA2023</b>	12800120	<b>BA2236</b>	1H0 611 701 F	<b>BAH0005</b>
77 01 349 780	<b>BAE5008</b>	12803551	<b>BA2236</b>	1H0 611 775	<b>BAH0016</b>
77 01 349 969	<b>BA2055</b>	13322091	<b>BA2258</b>	1H0 615 301 A	<b>BAR22100</b>
77 01 349 970	<b>BA2023</b>	32025723	<b>BAR25119</b>	1H0 698 151	<b>BA2132</b>
77 01 349 973	<b>BA2023</b>	4467072	<b>BA2098</b>	1H0 698 151 A	<b>BA2145</b>
77 01 454 307	<b>BA2082</b>	4478254	<b>BA2207</b>	1H0 698 151 B	<b>BA2153</b>
77 01 454 308	<b>BA2082</b>	4565693	<b>BAR10226</b>	1H0 698 451	<b>BA2017</b>
77 04 003 887	<b>BAH0024</b>	4566840	<b>BAR25119</b>	1H0 698 451 A	<b>BA2017</b>
77 04 003 949	<b>BAH0024</b>	4567798	<b>BAR25142</b>	1H0 698 451 B	<b>BA2032</b>
77 11 130 008	<b>BA2055</b>	4836987	<b>BA2095</b>	1H0 698 451 C	<b>BA2032</b>
77 11 130 034	<b>BA2055</b>	4837019	<b>BAR25119</b>	1H0 698 451 D	<b>BA2017</b>
77 11 130 036	<b>BA2023</b>	4837241	<b>BA2095</b>	1H0 698 451 E	<b>BA2032</b>
77 11 130 038	<b>BAR21106</b>	4839007	<b>BAR25119</b>	1H0 698 451 F	<b>BA2032</b>
77 11 130 071	<b>BA2023</b>	4839015	<b>BAR10226</b>	1H0 698 451 G	<b>BA2017</b>
77 11 130 077	<b>BAR28132</b>	4839320	<b>BAR25119</b>	1H0 698 451 H	<b>BA2032</b>
77 11 130 086	<b>BA2317</b>	4839338	<b>BAR10226</b>	1H0 698 525	<b>BAE5001</b>
82 00 010 519	<b>BAR28132</b>	5055389	<b>BAR25142</b>	1H0 698 525 V	<b>BAE5001</b>
82 00 131 598	<b>BAH0024</b>	5057336	<b>BA2095</b>	1H0 698 525 X	<b>BAE5001</b>
86 71 000 107	<b>BA2023</b>	5058110	<b>BA2053</b>	1HM 698 151	<b>BA2018</b>
		5390786	<b>BAR25119</b>	1HM 698 151 A	<b>BA2018</b>
<b>ROVER</b>		5391560	<b>BAR25142</b>	1J0 609 525	<b>BAE5009</b>
		5391578	<b>BAR10226</b>	1J0 609 526	<b>BAE5009</b>
GBD90840	<b>BAR21105</b>	9156785	<b>BAR12157</b>	1J0 609 527	<b>BAE5009</b>
GBD90844	<b>BAR22206</b>	9156807	<b>BAR25141</b>	1J0 609 528	<b>BAE5009</b>
GBP90313	<b>BA2010</b>	9184405	<b>BAR25142</b>	1J0 611 701	<b>BAH0023</b>
GBP90314	<b>BA2012</b>	93166943	<b>BA2236</b>	1J0 611 775	<b>BAH0033</b>
GBP90315AF	<b>BA2010</b>	93171497	<b>BAR25141</b>	1J0 615 301 C	<b>BAR25113</b>
GBP90318	<b>BA2011</b>	93183140	<b>BA2235</b>	1J0 615 301 D	<b>BAR22151</b>
GBP90320	<b>BA2011</b>	93185751	<b>BA2236</b>	1J0 615 301 E	<b>BAR22150</b>
GBP90336AF	<b>BA2010</b>	93188111	<b>BA2236</b>	1J0 615 301 L	<b>BAR22151</b>
GBP90340AF	<b>BA2010</b>	93190338	<b>BA2258</b>	1J0 615 301 M	<b>BAR22150</b>
GBP90341AF	<b>BA2053</b>			1J0 615 301 R	<b>BAR25113</b>
GWC901634	<b>BAW1911</b>	<b>SEAT</b>		1J0 615 301 S	<b>BAR25113</b>
GWC901635	<b>BAW1911</b>			1J0 615 601	<b>BAR09123</b>
SDB000880	<b>BAR22206</b>	140 698 151 B	<b>BA2153</b>	1J0 615 601 C	<b>BAR09123</b>
SDB000990	<b>BAR21105</b>	171 611 701 L	<b>BAH0010</b>	1J0 698 151	<b>BA2154</b>
SDB100600	<b>BAR21105</b>	171 611 775	<b>BAH0011</b>	1J0 698 151 A	<b>BA2154</b>
SDB100940	<b>BAR22206</b>	191 611 701	<b>BAH0010</b>	1J0 698 151 B	<b>BA2154</b>
SEB000290	<b>BA2010</b>	191 698 151 F	<b>BA2131</b>	1J0 698 151 D	<b>BA2155</b>
SFP000040	<b>BA2190</b>	191 698 151 G	<b>BA2133</b>	1J0 698 151 E	<b>BA2155</b>
SFP000390	<b>BA2010</b>	191 698 151 H	<b>BA2132</b>	1J0 698 151 G	<b>BA2155</b>
SFP000410	<b>BA2010</b>	191 698 151 J	<b>BA2132</b>	1J0 698 151 J	<b>BA2154</b>
SFP100220EVA	<b>BA2280</b>	191 698 151 K	<b>BA2132</b>	1J0 698 151 L	<b>BA2333</b>
SFP100260	<b>BA2010</b>	191 698 451 C	<b>BA2032</b>	1J0 698 151 M	<b>BA2205</b>
SFP100520	<b>BA2053</b>	191 698 451 D	<b>BA2032</b>	1J0 698 451	<b>BA2017</b>
SML000020	<b>BAW1911</b>	1H0 609 525	<b>BAE5001</b>	1J0 698 451 F	<b>BA2017</b>
SML000030	<b>BAW1911</b>	1H0 609 525 D	<b>BAE5001</b>	1J0 698 451 J	<b>BA2017</b>
SML100080	<b>BAW1911</b>	1H0 609 526	<b>BAE5001</b>	1J0 698 451 P	<b>BA2017</b>
SML100090	<b>BAW1911</b>	1H0 609 526 D	<b>BAE5001</b>	1J0 698 525	<b>BAE5009</b>
		1H0 609 527	<b>BAE5001</b>	1J0 698 525 A	<b>BAE5009</b>
<b>SAAB</b>		1H0 609 527 D	<b>BAE5001</b>	1J0 698 525 B	<b>BAE5009</b>
		1H0 609 528	<b>BAE5001</b>	1K0 615 301 AA	<b>BAR25158</b>
12759808	<b>BA2207</b>	1H0 609 528 D	<b>BAE5001</b>	1K0 615 301 AC	<b>BAR22210</b>
12762290	<b>BAR12157</b>	1H0 611 053	<b>BAW1905</b>	1K0 615 301 AK	<b>BAR22210</b>
12765397	<b>BA2236</b>	1H0 611 053 A	<b>BAW1501</b>	1K0 615 301 S	<b>BAR22210</b>
12799240	<b>BA2235</b>	1H0 611 701	<b>BAH0005</b>	1K0 615 301 T	<b>BAR25145</b>

# Vergleichsliste

Liste des correspondances / Tabella di conversione codici / Lista de comparação /



Lista porównawcza numerów / Porovnávací seznam čísel

SEAT		SEAT		SKODA	
1K0 698 151	<b>BA2195</b>	6R0 615 301	<b>BAR22151</b>	002 415 019	<b>BAR13182</b>
1K0 698 151 A	<b>BA2155</b>	6R0 698 151 A	<b>BA2154</b>	004 532 247 A	<b>BA2039</b>
1K0 698 151 D	<b>BA2155</b>	6X0 611 775	<b>BAH0033</b>	007 440 071 A	<b>BAE5001</b>
1K0 698 151 E	<b>BA2195</b>	7D0 615 301	<b>BAR26115</b>	007 440 077 A	<b>BAE5001</b>
1K0 698 151 F	<b>BA2155</b>	7D0 615 301 B	<b>BAR26115</b>	115 430 280	<b>BA2039</b>
1K0 698 151 J	<b>BA2155</b>	7D0 615 601 C	<b>BAR13194</b>	115 430 285	<b>BA2039</b>
1K0 698 451 A	<b>BA2017</b>	7D0 698 451 F	<b>BA2200</b>	1H0 611 053	<b>BAW1905</b>
1K0 698 451 C	<b>BA2017</b>	7M0 611 701 D	<b>BAH0007</b>	1H0 698 151 B	<b>BA2153</b>
1K0 698 451 J	<b>BA2017</b>	7M0 615 301 E	<b>BAR25114</b>	1J0 609 525	<b>BAE5009</b>
321 615 301	<b>BAR12106</b>	7M0 615 301 G	<b>BAR25114</b>	1J0 609 526	<b>BAE5009</b>
321 615 301 C	<b>BAR20123</b>	7M0 615 601 A	<b>BAR10223</b>	1J0 609 527	<b>BAE5009</b>
321 615 301 D	<b>BAR20128</b>	7M0 615 601 B	<b>BAR10223</b>	1J0 609 528	<b>BAE5009</b>
331 611 051 A	<b>BAW1701</b>	7M0 615 601 C	<b>BAR10223</b>	1J0 611 701	<b>BAH0023</b>
331 698 051 A	<b>BAW1701</b>	7M0 698 151	<b>BA2147</b>	1J0 611 701 L	<b>BAH0023</b>
357 609 525 C	<b>BAE5006</b>	7M0 698 151 A	<b>BA2147</b>	1J0 611 775	<b>BAH0033</b>
357 609 526 C	<b>BAE5006</b>	7M0 698 151 B	<b>BA2147</b>	1J0 615 301 C	<b>BAR25113</b>
357 609 527	<b>BAE5001</b>	7M0 698 451	<b>BA2017</b>	1J0 615 301 D	<b>BAR22151</b>
357 609 527 E	<b>BAE5006</b>	7M3 611 701 A	<b>BAH0027</b>	1J0 615 301 E	<b>BAR22150</b>
357 609 528	<b>BAE5001</b>	7M3 611 701 B	<b>BAH0027</b>	1J0 615 301 L	<b>BAR22151</b>
357 609 528 E	<b>BAE5006</b>	7M3 611 701 C	<b>BAH0027</b>	1J0 615 301 M	<b>BAR22150</b>
357 615 301	<b>BAR13178</b>	7M3 615 301 A	<b>BAR26115</b>	1J0 615 301 R	<b>BAR25113</b>
357 615 601	<b>BAR10111</b>	7M3 698 151	<b>BA2269</b>	1J0 615 601	<b>BAR09123</b>
357 615 601 B	<b>BAR10203</b>	7M3 698 151 A	<b>BA2318</b>	1J0 615 601 D	<b>BAR09133</b>
357 698 151 A	<b>BA2037</b>	7M3 698 151 B	<b>BA2231</b>	1J0 698 151	<b>BA2154</b>
357 698 151 B	<b>BA2038</b>	7M3 698 451	<b>BA2228</b>	1J0 698 151 A	<b>BA2154</b>
357 698 151 E	<b>BA2018</b>	7M3 698 451 A	<b>BA2017</b>	1J0 698 151 B	<b>BA2154</b>
357 698 525 CV	<b>BAE5006</b>	7M3 698 451 B	<b>BA2228</b>	1J0 698 151 D	<b>BA2155</b>
357 698 525 CX	<b>BAE5006</b>	7M3 698 451 C	<b>BA2228</b>	1J0 698 151 E	<b>BA2155</b>
357 698 525 V	<b>BAE5001</b>	7M3 698 451 D	<b>BA2200</b>	1J0 698 151 G	<b>BA2155</b>
3A0 611 053	<b>BAW2004</b>	7M3 698 451 F	<b>BA2200</b>	1J0 698 151 J	<b>BA2154</b>
3A0 698 151	<b>BA2333</b>	811 609 525 E	<b>BAE5001</b>	1J0 698 151 L	<b>BA2333</b>
3A0 698 151 A	<b>BA2333</b>	811 609 526 E	<b>BAE5001</b>	1J0 698 151 M	<b>BA2205</b>
3C0 698 151 B	<b>BA2195</b>	811 615 301	<b>BAR10151</b>	1J0 698 451	<b>BA2017</b>
3C0 698 151 C	<b>BA2195</b>	867 609 525	<b>BAE5003</b>	1J0 698 451 F	<b>BA2017</b>
4341534	<b>BA2062</b>	867 609 526	<b>BAE5003</b>	1J0 698 451 J	<b>BA2017</b>
437 611 775	<b>BAH0003</b>	867 609 527	<b>BAE5003</b>	1J0 698 451 M	<b>BA2017</b>
5C0 698 151	<b>BA2154</b>	867 609 528	<b>BAE5003</b>	1J0 698 451 P	<b>BA2017</b>
5K0 698 151	<b>BA2195</b>	867 698 520 X	<b>BAE5003</b>	1J0 698 451 S	<b>BA2017</b>
6K0 611 701	<b>BAH0005</b>	867 698 525 V	<b>BAE5003</b>	1J0 698 525	<b>BAE5009</b>
6N0 611 053	<b>BAW1701</b>	867 698 525 X	<b>BAE5003</b>	1J0 698 525 A	<b>BAE5009</b>
6N0 611 701 B	<b>BAH0019</b>	893 611 775 A	<b>BAH0003</b>	1J0 698 525 B	<b>BAE5009</b>
6N0 615 301	<b>BAR10232</b>	8E0 611 707	<b>BAH0021</b>	1K0 615 301 AA	<b>BAR25158</b>
6N0 615 301 C	<b>BAR18106</b>	8E0 611 707 A	<b>BAH0021</b>	1K0 615 301 AC	<b>BAR22210</b>
6N0 615 301 D	<b>BAR20128</b>	8E0 611 707 D	<b>BAH0021</b>	1K0 615 301 AK	<b>BAR22210</b>
6N0 615 601 A	<b>BAR09124</b>	8E0 611 707 G	<b>BAH0021</b>	1K0 615 301 S	<b>BAR22210</b>
6N0 615 601 B	<b>BAR09124</b>	8E0 698 151 G	<b>BA2259</b>	1K0 615 301 T	<b>BAR25145</b>
6N0 698 151	<b>BA2152</b>	8E0 698 151 K	<b>BA2172</b>	1K0 615 601 AC	<b>BAR12158</b>
6N0 698 151 C	<b>BA2152</b>	8E0 698 151 L	<b>BA2259</b>	1K0 615 601 AD	<b>BAR12169</b>
6Q0 611 053 C	<b>BAW1701</b>	8E0 698 451 J	<b>BA2196</b>	1K0 615 601 L	<b>BAR12158</b>
6Q0 611 775 A	<b>BAH0033</b>	8E0 698 451 L	<b>BA2032</b>	1K0 615 601 M	<b>BAR12169</b>
6Q0 611 775 B	<b>BAH0033</b>	8N0 615 301 A	<b>BAR25123</b>	1K0 698 151	<b>BA2195</b>
6Q0 698 151	<b>BA2154</b>	8N0 698 151	<b>BA2333</b>	1K0 698 151 A	<b>BA2155</b>
6Q0 698 151 C	<b>BA2298</b>	8N0 698 151 A	<b>BA2205</b>	1K0 698 151 D	<b>BA2155</b>
6Q0 698 525	<b>BAE5001</b>	8Z0 698 151 A	<b>BA2155</b>	1K0 698 151 E	<b>BA2195</b>
6Q0 698 525 A	<b>BAE5001</b>	SE025720002A	<b>BAW1902</b>	1K0 698 151 F	<b>BA2155</b>
6Q0 698 525 B	<b>BAE5001</b>	SE028720001A	<b>BAW1902</b>	1K0 698 151 J	<b>BA2155</b>

# Vergleichsliste

Liste des correspondances / Tabella di conversione codici / Lista de comparação /



Lista porównawcza numerów / Porovnávací seznam čísel

SKODA 	SKODA 	TOYOTA 
1K0 698 451 C	<b>BA2017</b>	04465-05131 <b>BA2295</b>
1K0 698 451 D	<b>BA2196</b>	04465-05170 <b>BA2295</b>
1K0 698 451 G	<b>BA2196</b>	04465-05210 <b>BA2295</b>
1K0 698 451 J	<b>BA2017</b>	04465-0H020 <b>BA2296</b>
1K0 698 451 K	<b>BA2196</b>	04465-0W050 <b>BA2294</b>
3A0 611 053	<b>BAW2004</b>	04465-10040 <b>BA2121</b>
3A0 698 151	<b>BA2333</b>	04465-12040 <b>BA2121</b>
3A0 698 151 A	<b>BA2333</b>	04465-12090 <b>BA2121</b>
3B0 698 451 A	<b>BA2017</b>	04465-12240 <b>BA2121</b>
3C0 698 151 B	<b>BA2195</b>	04465-12540 <b>BA2116</b>
3C0 698 151 C	<b>BA2195</b>	04465-13020 <b>BA2294</b>
3U0 611 707	<b>BAH0013</b>	04465-13050 <b>BA2294</b>
4A0 615 301 C	<b>BAR25105</b>	04465-16120 <b>BA2121</b>
4A0 615 601 A	<b>BAR10201</b>	04465-17100 <b>BA2294</b>
4B0 615 301 A	<b>BAR25137</b>	04465-17101 <b>BA2294</b>
4B0 615 301 B	<b>BAR25171</b>	04465-17140 <b>BA2294</b>
4B0 698 151 N	<b>BA2172</b>	04465-20120 <b>BA2116</b>
5C0 698 151	<b>BA2154</b>	04465-33040 <b>BA2116</b>
5K0 698 151	<b>BA2195</b>	04465-42010 <b>BA2116</b>
5K0 698 151 A	<b>BA2195</b>	04465-42011 <b>BA2116</b>
6N0 698 151 C	<b>BA2152</b>	04465-42012 <b>BA2116</b>
6Q0 611 053 C	<b>BAW1701</b>	04465-42050 <b>BA2116</b>
6Q0 611 775 A	<b>BAH0033</b>	04465-44020 <b>BA2116</b>
6Q0 611 775 B	<b>BAH0033</b>	04465-44040 <b>BA2116</b>
6Q0 615 301	<b>BAR18137</b>	04465-44120 <b>BA2116</b>
6Q0 698 151	<b>BA2154</b>	04465-44130 <b>BA2116</b>
6Q0 698 151 C	<b>BA2298</b>	04465-52010 <b>BA2294</b>
6Q0 698 525	<b>BAE5001</b>	04465-52011 <b>BA2294</b>
6Q0 698 525 A	<b>BAE5001</b>	04465-52021 <b>BA2294</b>
6Q0 698 525 B	<b>BAE5001</b>	04465-52022 <b>BA2294</b>
6R0 615 301	<b>BAR22151</b>	04465-52060 <b>BA2294</b>
6R0 615 301 A	<b>BAR25113</b>	04465-52120 <b>BA2294</b>
6R0 698 151 A	<b>BA2154</b>	04465-74020 <b>BA2294</b>
6U0 615 301	<b>BAR13182</b>	04466-02020 <b>BA2331</b>
6U0 698 151	<b>BA2039</b>	04466-02070 <b>BA2331</b>
6U0 698 151 A	<b>BA2039</b>	04466-02160 <b>BA2331</b>
6U0 698 151 D	<b>BA2039</b>	04466-05010 <b>BA2326</b>
6U0 698 151 E	<b>BA2039</b>	04466-05020 <b>BA2326</b>
6U0 698 525	<b>BAE5001</b>	04466-28110 <b>BA2326</b>
6U0 698 525 A	<b>BAE5001</b>	04466-52010 <b>BA2293</b>
6X0 611 775	<b>BAH0033</b>	04466-52020 <b>BA2293</b>
6Y0 609 525 A	<b>BAE5001</b>	04466-52030 <b>BA2293</b>
6Y0 609 526 A	<b>BAE5001</b>	04466-52040 <b>BA2293</b>
6Y0 609 527 A	<b>BAE5001</b>	04466-52050 <b>BA2293</b>
6Y0 609 528 A	<b>BAE5001</b>	04466-52060 <b>BA2293</b>
8D0 611 707 B	<b>BAH0013</b>	04466-58010 <b>BA2326</b>
8D0 611 707 D	<b>BAH0013</b>	04491-05010 <b>BA2116</b>
8D0 615 301 J	<b>BAR25137</b>	04491-06010 <b>BA2116</b>
8E0 615 301 Q	<b>BAR25105</b>	04491-10160 <b>BA2121</b>
8E0 615 301 R	<b>BAR25137</b>	04491-10161 <b>BA2121</b>
8E0 615 601	<b>BAR10201</b>	04491-12170 <b>BA2121</b>
8E0 698 151 J	<b>BA2172</b>	04491-12230 <b>BA2121</b>
8E0 698 451 A	<b>BA2017</b>	04491-12231 <b>BA2121</b>
8E0 698 451 K	<b>BA2017</b>	04491-12250 <b>BA2121</b>
8N0 615 301 A	<b>BAR25123</b>	04491-12251 <b>BA2121</b>
8N0 698 151	<b>BA2333</b>	04491-12270 <b>BA2121</b>
8N0 698 151 A	<b>BA2205</b>	
8Z0 698 151 A	<b>BA2155</b>	
<b>SMART (MCC)</b>		
000 1431 V002 000000	<b>BA2217</b>	
000 1431 V003 000000	<b>BA2217</b>	
000 1440 V001 000000	<b>BAE5040</b>	
000 4341 V001 000000	<b>BAR09136</b>	
000 4341 V002 000000	<b>BAR09136</b>	
000 6644 V001 000000	<b>BAW2204</b>	
000 6645 V001 000000	<b>BAW2206</b>	
000 7333 V001 000000	<b>BAE5040</b>	
414 596 00 02	<b>BA2217</b>	
451 421 00 10	<b>BA2217</b>	
454 420 00 01	<b>BAR24192</b>	
454 420 00 72	<b>BAR10304</b>	
454 420 09 20	<b>BA2268</b>	
454 420 10 20	<b>BA2226</b>	
454 421 00 10	<b>BA2237</b>	
<b>STEYR-DAIMLER-PUCH</b>		
559 0 00 150 286	<b>BA2185</b>	
<b>SUBARU</b>		
5581084E01	<b>BA2260</b>	
<b>SUZUKI</b>		
55800-80J00	<b>BA2280</b>	
55800-80J01	<b>BA2280</b>	
55800-80J02	<b>BA2280</b>	
55810-62J00	<b>BA2301</b>	
55810-62J01	<b>BA2301</b>	
55810-62J20	<b>BA2301</b>	
55810-62J31	<b>BA2301</b>	
55810-62J50	<b>BA2301</b>	
55810-83E00	<b>BA2260</b>	
55810-84E01	<b>BA2260</b>	
<b>TALBOT</b>		
306401 00	<b>BA2082</b>	
306663 00	<b>BA2082</b>	
309920 00	<b>BA2082</b>	
327082 00	<b>BA2082</b>	
327960 00	<b>BA2082</b>	
328635 00	<b>BA2082</b>	
<b>TOYOTA</b>		
04465-02061	<b>BA2270</b>	
04465-02130	<b>BA2270</b>	
04465-05130	<b>BA2295</b>	

# Vergleichsliste

Liste des correspondances / Tabella di conversione codici / Lista de comparação /



Lista porównawcza numerów / Porovnávací seznam čísel

TOYOTA		TOYOTA		VOLKSWAGEN	
04491-12320	BA2121	04495-12210	BAE5035	191 698 151 G	BA2133
04491-12321	BA2121	04495-12220	BAE5035	191 698 151 H	BA2132
04491-12322	BA2121	04495-20090	BAE5035	191 698 151 J	BA2132
04491-12330	BA2121	04495-20091	BAE5035	191 698 151 K	BA2132
04491-12331	BA2121	04495-20092	BAE5035	191 698 451	BA2032
04491-12421	BA2121	04495-20100	BAE5035	191 698 451 A	BA2032
04491-12422	BA2121	04495-20101	BAE5035	191 698 451 B	BA2032
04491-12432	BA2121	04495-20150	BAE5035	191 698 451 C	BA2032
04491-12440	BA2121	04495-32010	BAE5035	191 698 451 D	BA2032
04491-12490	BA2121	04495-32030	BAE5035	1E0 698 451	BA2017
04491-12540	BA2121	04495-32031	BAE5035	1E0 698 451 A	BA2032
04491-12541	BA2121	42431-02070	BAR09138	1E0 698 451 B	BA2017
04491-12560	BA2121	42431-0D050	BAR09139	1E0 698 451 C	BA2017
04491-12561	BA2121	42431-12210	BAR09139	1E0 698 451 D	BA2017
04491-12580	BA2121	42431-12250	BAR09139	1E0 698 451 E	BA2017
04491-12581	BA2121	42431-47020	BAR09139	1E0 698 451 G	BA2017
04491-12630	BA2121	42431-52050	BAR09139	1GD 698 151	BA2132
04491-12640	BA2116	43512-05080	BAR26138	1H0 611 053	BAW1905
04491-12650	BA2116	43512-0F010	BAR26138	1H0 611 053 A	BAW1501
04491-12651	BA2116	43512-12550	BAR22158	1H0 611 053 B	BAW1401
04491-16052	BA2121	43512-16070	BAR18124	1H0 611 701	BAH0005
04491-17020	BA2121	43512-16120	BAR18124	1H0 611 701 F	BAH0005
04491-17021	BA2121	43512-20470	BAR25124	1H0 611 775	BAH0016
04491-17022	BA2121	43512-20480	BAR25124	1H0 615 301	BAR22100
04491-17030	BA2121	43512-20580	BAR25124	1H0 615 301 A	BAR22100
04491-17040	BA2121	43512-20700	BAR25124	1H0 698 071	BAE5001
04491-17050	BA2121			1H0 698 151	BA2132
04491-17060	BA2121	<b>VOLKSWAGEN</b>		1H0 698 151 A	BA2145
04491-17061	BA2121			1H0 698 151 B	BA2153
04491-17070	BA2121	171 609 525 A	BAE5003	1H0 698 451	BA2017
04491-17080	BA2121	171 609 526 A	BAE5003	1H0 698 451 A	BA2017
04491-17081	BA2121	171 609 527 F	BAE5003	1H0 698 451 B	BA2032
04491-20191	BA2121	171 609 528 F	BAE5003	1H0 698 451 C	BA2032
04491-20220	BA2121	171 611 051 B	BAW1401	1H0 698 451 D	BA2017
04491-20310	BA2121	171 611 053	BAW1401	1H0 698 451 E	BA2032
04491-20451	BA2121	171 611 053 A	BAW1401	1H0 698 451 F	BA2032
04491-20470	BA2121	171 611 701 G	BAH0010	1H0 698 451 G	BA2017
04491-20471	BA2121	171 611 701 H	BAH0010	1H0 698 451 H	BA2032
04491-20500	BA2121	171 611 701 L	BAH0010	1H0 698 520 V	BAE5001
04491-20501	BA2121	171 611 775	BAH0011	1H0 698 520 X	BAE5001
04491-20580	BA2121	171 698 151 F	BA2132	1H0 698 525 V	BAE5001
04491-20620	BA2121	171 698 151 G	BA2132	1H0 698 525 X	BAE5001
04491-20820	BA2121	175 611 701 A	BAH0010	1HM 698 151	BA2018
04491-20880	BA2116	175 615 301	BAR12106	1HM 698 151 A	BA2018
04491-20890	BA2116	175 698 151	BA2132	1J0 609 525	BAE5009
04491-22370	BA2116	176 698 151	BA2132	1J0 609 526	BAE5009
04491-2B010	BA2116	191 611 701	BAH0010	1J0 609 527	BAE5009
04491-32010	BA2121	191 615 601	BAR10111	1J0 609 528	BAE5009
04491-32011	BA2121	191 615 601 B	BAR10111	1J0 611 701	BAH0023
04491-32030	BA2121	191 698 151	BA2131	1J0 611 701 L	BAH0023
04491-32080	BA2121	191 698 151 A	BA2131	1J0 611 775	BAH0033
04491-32190	BA2121	191 698 151 B	BA2133	1J0 615 301 C	BAR25113
04491-33010	BA2116	191 698 151 C	BA2132	1J0 615 301 D	BAR22151
04491-33011	BA2116	191 698 151 D	BA2132	1J0 615 301 E	BAR22150
04491-33030	BA2116	191 698 151 E	BA2131	1J0 615 301 K	BAR25113
04491-33060	BA2116	191 698 151 F	BA2131	1J0 615 301 L	BAR22151

# Vergleichsliste

Liste des correspondances / Tabella di conversione codici / Lista de comparação /



Lista porównawcza numerów / Porovnávací seznam čísel

VOLKSWAGEN		VOLKSWAGEN		VOLKSWAGEN	
1J0 615 301 M	BAR22150	1K0 698 451 B	BA2196	331 611 053 A	BAW1701
1J0 615 301 P	BAR22150	1K0 698 451 C	BA2017	357 609 525 C	BAE5006
1J0 615 301 R	BAR25113	1K0 698 451 D	BA2196	357 609 526 C	BAE5006
1J0 615 301 S	BAR25113	1K0 698 451 E	BA2196	357 609 527 E	BAE5006
1J0 615 601	BAR09123	1K0 698 451 F	BA2196	357 609 528 E	BAE5006
1J0 615 601 C	BAR09123	1K0 698 451 G	BA2196	357 611 053 B	BAW2004
1J0 615 601 D	BAR09133	1K0 698 451 H	BA2196	357 615 301	BAR13178
1J0 698 151	BA2154	1K0 698 451 J	BA2017	357 615 601	BAR10111
1J0 698 151 A	BA2154	1K0 698 451 K	BA2196	357 615 601 B	BAR10203
1J0 698 151 B	BA2154	1K0 698 451 M	BA2017	357 698 151	BA2038
1J0 698 151 C	BA2154	251 698 151 C	BA2025	357 698 151 A	BA2037
1J0 698 151 D	BA2155	251 698 151 F	BA2025	357 698 151 B	BA2038
1J0 698 151 E	BA2155	281 615 283 A	BAR20114	357 698 151 D	BA2037
1J0 698 151 F	BA2155	281 698 151	BA2109	357 698 151 E	BA2018
1J0 698 151 G	BA2155	281 698 151 A	BA2109	357 698 525 CV	BAE5006
1J0 698 151 J	BA2154	281 698 151 B	BA2109	357 698 525 CX	BAE5006
1J0 698 151 K	BA2205	2D0 611 701 B	BAH0020	357 698 525 V	BAE5001
1J0 698 151 L	BA2333	2D0 615 301 A	BAR22161	357 698 525 X	BAE5001
1J0 698 151 M	BA2205	2D0 615 301 B	BAR22161	3A0 611 053	BAW2004
1J0 698 451	BA2017	2D0 615 301 C	BAR22161	3A0 611 701	BAH0019
1J0 698 451 B	BA2017	2D0 615 301 D	BAR22161	3A0 698 151	BA2333
1J0 698 451 C	BA2017	2D0 615 601	BAR12142	3A0 698 151 A	BA2333
1J0 698 451 D	BA2017	2D0 615 601 A	BAR16110	3B0 615 301 B	BAR25137
1J0 698 451 E	BA2017	2D0 615 601 B	BAR22196	3B0 698 451	BA2017
1J0 698 451 F	BA2017	2D0 615 601 C	BAR12142	3B0 698 451 A	BA2017
1J0 698 451 G	BA2017	2D0 615 601 D	BAR16110	3C0 698 151	BA2195
1J0 698 451 H	BA2017	2D0 698 151	BA2149	3C0 698 151 A	BA2195
1J0 698 451 J	BA2017	2D0 698 151 A	BA2239	3C0 698 151 B	BA2195
1J0 698 451 K	BA2032	2D0 698 151 B	BA2239	3C0 698 151 C	BA2195
1J0 698 451 L	BA2032	2D0 698 451	BA2215	3C0 698 151 D	BA2195
1J0 698 451 N	BA2032	2D0 698 451 A	BA2233	3C0 698 451	BA2196
1J0 698 451 P	BA2017	2D0 698 451 B	BA2216	3C0 698 451 A	BA2196
1J0 698 451 R	BA2017	2D0 698 451 C	BA2233	3C0 698 451 B	BA2196
1J0 698 525	BAE5009	2D0 919 351	BAV1008	3C0 698 451 C	BA2196
1J0 698 525 A	BAE5009	2E0 698 151	BA2281	3U0 611 707	BAH0013
1J0 698 525 B	BAE5009	2E0 698 151 B	BA2281	431 609 525	BAE5006
1JD 698 451	BA2017	2E0 698 451	BA2277	431 609 526	BAE5006
1K0 615 301 AA	BAR25158	2E0 906 206 G	BAV1048	431 609 527 E	BAE5006
1K0 615 301 AC	BAR22210	321 611 053 A	BAW1701	431 609 528 E	BAE5006
1K0 615 301 AK	BAR22210	321 611 701 B	BAH0010	431 611 775 A	BAH0015
1K0 615 301 K	BAR25145	321 611 775	BAH0015	431 615 301	BAR13160
1K0 615 301 S	BAR22210	321 615 301	BAR12106	431 615 301 A	BAR22118
1K0 615 301 T	BAR25145	321 615 301 A	BAR20123	431 698 071 E	BAE5001
1K0 615 601 AC	BAR12158	321 615 301 B	BAR20123	431 698 073 E	BAE5001
1K0 615 601 AD	BAR12169	321 615 301 C	BAR20123	431 698 151 D	BA2031
1K0 615 601 L	BAR12158	321 615 301 D	BAR20128	431 698 151 F	BA2031
1K0 615 601 M	BAR12169	321 698 151	BA2132	431 698 151 G	BA2031
1K0 698 151	BA2195	321 698 151 B	BA2133	433 611 775 A	BAH0015
1K0 698 151 A	BA2155	321 698 151 C	BA2132	437 611 775	BAH0003
1K0 698 151 C	BA2195	321 698 151 D	BA2133	437 698 151	BA2031
1K0 698 151 D	BA2155	321 698 151 E	BA2133	437 698 451	BA2052
1K0 698 151 E	BA2195	321 698 151 F	BA2132	443 609 525 A	BAE5006
1K0 698 151 F	BA2155	321 698 151 G	BA2132	443 609 526 A	BAE5006
1K0 698 151 J	BA2155	321 698 151 H	BA2133	443 609 527 A	BAE5006
1K0 698 451	BA2196	331 611 051 A	BAW1701	443 609 528 A	BAE5006
1K0 698 451 A	BA2017	331 611 053	BAW1701	443 615 301	BAR13160

# Vergleichsliste

Liste des correspondances / Tabella di conversione codici / Lista de comparação /



Lista porównawcza numerów / Porovnávací seznam čísel

VOLKSWAGEN		VOLKSWAGEN		VOLKSWAGEN	
443 615 301 A	BAR22118	4D0 698 451	BA2052	6Q0 615 301 A	BAR18137
443 615 301 B	BAR22118	4D0 698 451 A	BA2052	6Q0 698 151	BA2154
443 615 601	BAR10178	4D0 698 451 B	BA2052	6Q0 698 151 C	BA2298
443 698 151 A	BA2028	4D0 698 451 C	BA2017	6Q0 698 525	BAE5001
443 698 151 C	BA2028	4D0 698 451 F	BA2052	6Q0 698 525 A	BAE5001
443 698 151 D	BA2028	4D0 698 451 G	BA2052	6Q0 698 525 B	BAE5001
443 698 151 F	BA2028	4E0 698 151 F	BA2259	6R0 615 301	BAR22151
443 698 151 F	BA2031	4E0 698 151 M	BA2259	6R0 615 301 A	BAR25113
443 698 151 G	BA2028	4F0 698 151	BA2172	6R0 698 151 A	BA2154
443 698 151 J	BA2028	4F0 698 151 A	BA2259	6U0 615 301	BAR13182
443 698 151 K	BA2028	4F0 698 151 D	BA2259	6U0 698 151	BA2039
443 698 451	BA2052	4F0 698 451 A	BA2196	6U0 698 151 A	BA2039
443 698 451 A	BA2052	4F0 698 451 B	BA2196	6U0 698 525	BAE5001
443 698 451 B	BA2052	4F0 698 451 D	BA2196	6U0 698 525 A	BAE5001
443 698 451 C	BA2052	4F0 698 451 E	BA2196	6X0 611 775	BAH0033
443 698 525 BV	BAE5006	531 609 525	BAE5003	701 611 047	BAW2002
443 698 525 BX	BAE5006	531 609 526	BAE5003	701 611 701 A	BAH0022
443 698 525 CX	BAE5006	531 609 527	BAE5003	701 615 301 A	BAR24118
447 698 451	BA2052	531 609 528	BAE5003	701 615 301 B	BAR18105
447 698 451 A	BA2052	533 698 151 A	BA2037	701 615 301 D	BAR24118
447 698 451 C	BA2052	535 611 701	BAH0014	701 615 301 E	BAR18105
481 611 775	BAH0003	5C0 615 301	BAR22210	701 615 301 F	BAR24128
481 611 776	BAH0011	5C0 615 301 A	BAR25145	701 615 301 G	BAR18111
4A0 611 707	BAH0026	5C0 615 301 B	BAR25158	701 615 601 A	BAR12138
4A0 615 301 B	BAR15105	5C0 698 151	BA2154	701 698 151 B	BA2322
4A0 615 301 C	BAR25105	5K0 698 151	BA2195	701 698 151 D	BA2049
4A0 615 301 D	BAR25105	5K0 698 151 A	BA2195	701 698 151 E	BA2049
4A0 615 301 E	BAR25105	6842 067 20 06 000	BAH0004	701 698 151 F	BA2322
4A0 615 601 A	BAR10201	6K0 611 701	BAH0005	701 698 151 G	BA2322
4A0 698 151	BA2135	6N0 611 053	BAW1701	701 698 151 H	BA2322
4A0 698 151 C	BA2135	6N0 611 701	BAH0019	701 698 151 J	BA2049
4A0 698 451	BA2052	6N0 611 701 A	BAH0019	701 698 451	BA2202
4B0 615 301 A	BAR25137	6N0 611 701 B	BAH0019	701 698 525	BAE5024
4B0 615 301 B	BAR25171	6N0 615 301	BAR10232	701 698 525 A	BAE5024
4B0 615 601	BAR10258	6N0 615 301 C	BAR18106	701 698 525 B	BAE5024
4B0 615 601 A	BAR10259	6N0 615 301 D	BAR20128	721 611 047	BAW2002
4B0 615 601 B	BAR10260	6N0 615 301 F	BAR18106	7D0 611 701 C	BAH0022
4B0 698 151	BA2172	6N0 615 601	BAR10111	7D0 611 701 E	BAH0022
4B0 698 151 A	BA2172	6N0 615 601 A	BAR09124	7D0 615 301	BAR26115
4B0 698 151 AB	BA2172	6N0 615 601 B	BAR09124	7D0 615 301 A	BAR24128
4B0 698 151 AC	BA2246	6N0 698 151	BA2152	7D0 615 301 B	BAR26115
4B0 698 151 AD	BA2246	6N0 698 151 A	BA2018	7D0 615 301 C	BAR24128
4B0 698 151 AF	BA2172	6N0 698 151 B	BA2018	7D0 615 601	BAR12138
4B0 698 151 B	BA2172	6N0 698 151 C	BA2152	7D0 615 601 A	BAR13194
4B0 698 151 E	BA2172	6Q0 609 525 A	BAE5001	7D0 615 601 B	BAR12138
4B0 698 151 H	BA2172	6Q0 609 525 B	BAE5001	7D0 615 601 C	BAR13194
4B0 698 151 J	BA2172	6Q0 609 526 A	BAE5001	7D0 698 151	BA2171
4B0 698 151 K	BA2172	6Q0 609 526 B	BAE5001	7D0 698 151 B	BA2321
4B0 698 151 M	BA2172	6Q0 609 527 A	BAE5001	7D0 698 151 D	BA2201
4B0 698 151 N	BA2172	6Q0 609 527 B	BAE5001	7D0 698 151 E	BA2171
4B0 698 151 Q	BA2246	6Q0 609 528 A	BAE5001	7D0 698 151 F	BA2201
4B0 698 151 R	BA2246	6Q0 609 528 B	BAE5001	7D0 698 151 G	BA2321
4B0 698 451	BA2017	6Q0 611 053 C	BAW1701	7D0 698 451	BA2202
4B0 698 451 A	BA2017	6Q0 611 775 A	BAH0033	7D0 698 451 A	BA2202
4B0 698 451 B	BA2017	6Q0 611 775 B	BAH0033	7D0 698 451 B	BA2200
4B0 698 451 E	BA2017	6Q0 615 301	BAR18137	7D0 698 451 C	BA2200

# Vergleichsliste

Liste des correspondances / Tabella di conversione codici / Lista de comparação /

Lista porównawcza numerów / Porovnávací seznam čísel

<b>VOLKSWAGEN</b>		<b>VOLKSWAGEN</b>		<b>VOLKSWAGEN</b>	
7D0 698 451 D	<b>BA2202</b>	867 609 525	<b>BAE5003</b>	8E0 698 151 M	<b>BA2198</b>
7D0 698 451 E	<b>BA2202</b>	867 609 526	<b>BAE5003</b>	8E0 698 151 N	<b>BA2160</b>
7D0 698 451 F	<b>BA2200</b>	867 609 527	<b>BAE5003</b>	8E0 698 451	<b>BA2017</b>
7D0 698 451 G	<b>BA2202</b>	867 609 528	<b>BAE5003</b>	8E0 698 451 A	<b>BA2017</b>
7D0 698 451 J	<b>BA2202</b>	867 698 151	<b>BA2141</b>	8E0 698 451 D	<b>BA2032</b>
7H0 615 601 B	<b>BAR22211</b>	867 698 520 X	<b>BAE5003</b>	8E0 698 451 E	<b>BA2032</b>
7H0 698 151	<b>BA2242</b>	867 698 525 V	<b>BAE5003</b>	8E0 698 451 F	<b>BA2196</b>
7H0 698 151 A	<b>BA2242</b>	867 698 525 X	<b>BAE5003</b>	8E0 698 451 J	<b>BA2196</b>
7H0 698 151 B	<b>BA2242</b>	893 611 707	<b>BAH0012</b>	8E0 698 451 K	<b>BA2017</b>
7H0 698 151 C	<b>BA2242</b>	893 611 775 A	<b>BAH0003</b>	8E0 698 451 L	<b>BA2032</b>
7H0 698 451	<b>BA2243</b>	895 615 301	<b>BAR13166</b>	8E0 698 451 M	<b>BA2196</b>
7H0 698 451 B	<b>BA2243</b>	895 615 301 A	<b>BAR22108</b>	8L0 615 301	<b>BAR25123</b>
7H8 698 451	<b>BA2327</b>	895 615 601 A	<b>BAR10261</b>	8L0 615 601	<b>BAR22163</b>
7L0 907 637	<b>BAV1052</b>	8A0 615 301 A	<b>BAR22139</b>	8N0 615 301 A	<b>BAR25123</b>
7L0 907 637 B	<b>BAV1053</b>	8A0 615 301 E	<b>BAR22139</b>	8N0 615 601 B	<b>BAR22163</b>
7L0 907 637 C	<b>BAV1053</b>	8A0 698 151	<b>BA2031</b>	8N0 698 151	<b>BA2333</b>
7M0 611 701 D	<b>BAH0007</b>	8A0 698 151 A	<b>BA2031</b>	8N0 698 151 A	<b>BA2205</b>
7M0 615 301 E	<b>BAR25114</b>	8A0 698 151 B	<b>BA2031</b>	8Z0 615 301 B	<b>BAR22151</b>
7M0 615 301 G	<b>BAR25114</b>	8A0 698 151 C	<b>BA2031</b>	8Z0 615 301 D	<b>BAR22151</b>
7M0 615 601 A	<b>BAR10223</b>	8A0 698 151 E	<b>BA2031</b>	8Z0 698 151 A	<b>BA2155</b>
7M0 615 601 B	<b>BAR10223</b>	8D0 611 707	<b>BAH0013</b>	JZW 698 151	<b>BA2155</b>
7M0 615 601 C	<b>BAR10223</b>	8D0 611 707 B	<b>BAH0013</b>	JZW 698 151 A	<b>BA2154</b>
7M0 698 151	<b>BA2147</b>	8D0 611 707 D	<b>BAH0013</b>		
7M0 698 151 A	<b>BA2147</b>	8D0 615 301 J	<b>BAR25137</b>	<b>VOLVO</b>	
7M0 698 151 B	<b>BA2147</b>	8D0 615 301 K	<b>BAR30113</b>		
7M0 698 451	<b>BA2017</b>	8D0 615 301 M	<b>BAR30113</b>	1205782	<b>BAR10189</b>
7M3 611 701	<b>BAH0027</b>	8D0 615 601 A	<b>BAR10224</b>	270736	<b>BAR10189</b>
7M3 611 701 A	<b>BAH0027</b>	8D0 615 601 B	<b>BAR10210</b>	271349	<b>BA2181</b>
7M3 611 701 B	<b>BAH0027</b>	8D0 698 151	<b>BA2031</b>	271587	<b>BA2244</b>
7M3 611 701 C	<b>BAH0027</b>	8D0 698 151 A	<b>BA2148</b>	271737	<b>BA2181</b>
7M3 615 301 A	<b>BAR26115</b>	8D0 698 151 C	<b>BA2148</b>	271788	<b>BAR26102</b>
7M3 698 151	<b>BA2269</b>	8D0 698 151 F	<b>BA2148</b>	271859	<b>BA2244</b>
7M3 698 151 A	<b>BA2318</b>	8D0 698 151 L	<b>BA2031</b>	271979	<b>BA2181</b>
7M3 698 151 B	<b>BA2231</b>	8E0 611 707	<b>BAH0021</b>	272312	<b>BAR26102</b>
7M3 698 451	<b>BA2228</b>	8E0 611 707 A	<b>BAH0021</b>	272343	<b>BA2244</b>
7M3 698 451 A	<b>BA2017</b>	8E0 611 707 D	<b>BAH0021</b>	272399	<b>BA2279</b>
7M3 698 451 B	<b>BA2228</b>	8E0 611 707 G	<b>BAH0021</b>	272401	<b>BA2253</b>
7M3 698 451 C	<b>BA2228</b>	8E0 615 301 A	<b>BAR25115</b>	272403	<b>BAR26122</b>
7M3 698 451 D	<b>BA2200</b>	8E0 615 301 AD	<b>BAR30113</b>	272404	<b>BAR28123</b>
7M3 698 451 E	<b>BA2228</b>	8E0 615 301 B	<b>BAR22152</b>	272407	<b>BA2162</b>
7M3 698 451 F	<b>BA2200</b>	8E0 615 301 C	<b>BAR25115</b>	272944	<b>BA2279</b>
811 615 301	<b>BAR10151</b>	8E0 615 301 D	<b>BAR22152</b>	274170	<b>BAR28123</b>
811 698 071	<b>BAE5001</b>	8E0 615 301 P	<b>BAR22152</b>	274334	<b>BA2279</b>
823 611 707	<b>BAH0010</b>	8E0 615 301 Q	<b>BAR25105</b>	274335	<b>BA2253</b>
823 615 301	<b>BAR10151</b>	8E0 615 301 R	<b>BAR25137</b>	274510	<b>BAR25162</b>
839 615 301	<b>BAR12106</b>	8E0 615 601	<b>BAR10201</b>	274559	<b>BAR28123</b>
841 615 301	<b>BAR20123</b>	8E0 615 601 A	<b>BAR10224</b>	30620770	<b>BA2226</b>
849 611 701 G	<b>BAH0010</b>	8E0 615 601 B	<b>BAR10261</b>	30623259	<b>BA2237</b>
849 611 707 A	<b>BAH0010</b>	8E0 615 601 P	<b>BAR10261</b>	30623264	<b>BA2226</b>
853 698 151 A	<b>BA2178</b>	8E0 698 151	<b>BA2160</b>	30648381	<b>BA2244</b>
857 698 451	<b>BA2052</b>	8E0 698 151 A	<b>BA2160</b>	30648382	<b>BA2279</b>
861 611 053	<b>BAW1905</b>	8E0 698 151 B	<b>BA2198</b>	30648385	<b>BA2253</b>
861 611 053 A	<b>BAW1501</b>	8E0 698 151 C	<b>BA2259</b>	30648387	<b>BA2253</b>
861 611 707 A	<b>BAH0008</b>	8E0 698 151 F	<b>BA2172</b>	30681739	<b>BA2234</b>
861 611 707 B	<b>BAH0008</b>	8E0 698 151 G	<b>BA2259</b>	30683554	<b>BA2234</b>
861 611 707 C	<b>BAH0008</b>	8E0 698 151 K	<b>BA2172</b>	30715023	<b>BA2234</b>





# Notizen

Notes / Note / Notas / Uwagi / Poznámky

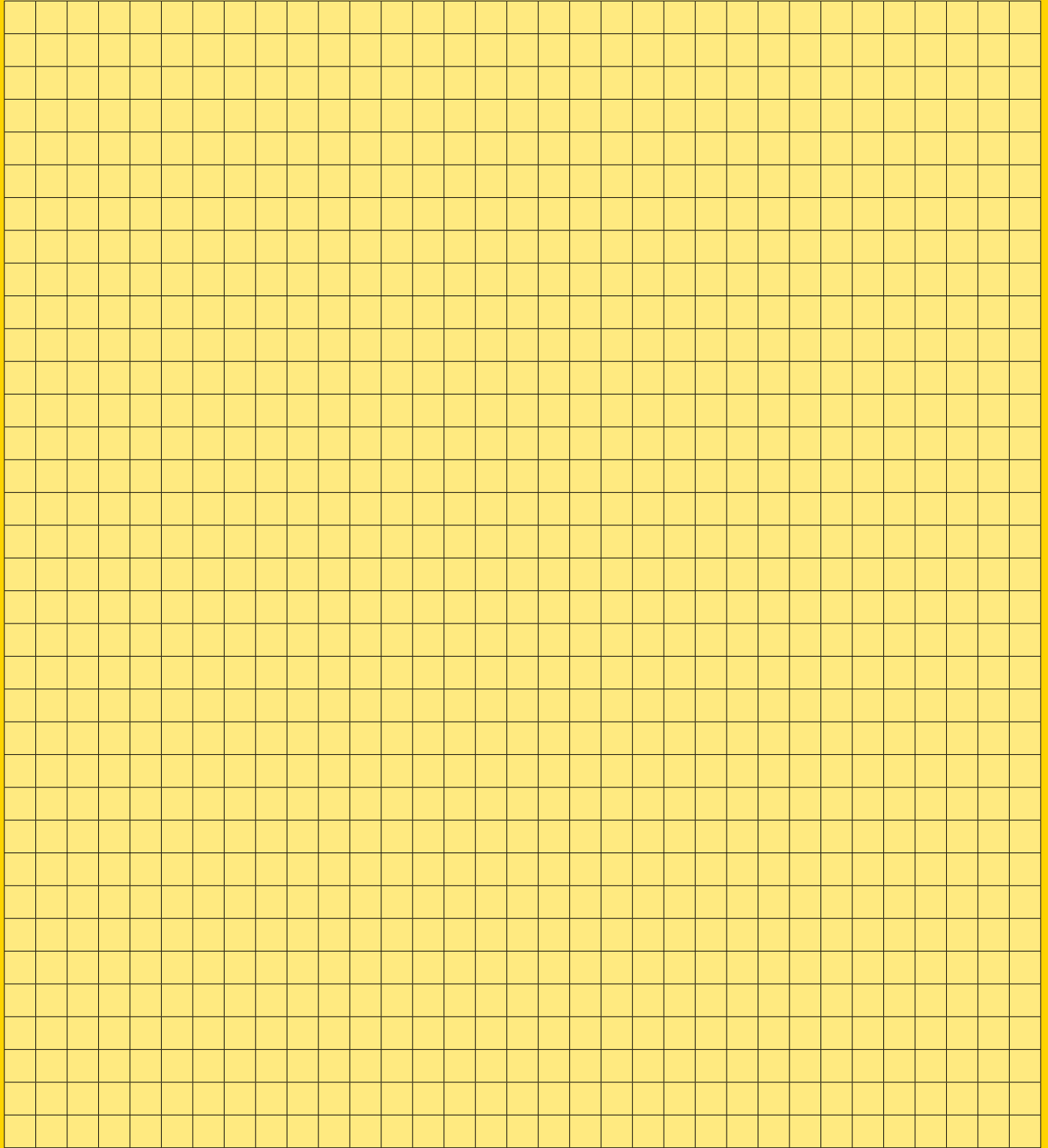

# Notizen

Notes / Note / Notas / Uwagi / Poznámky

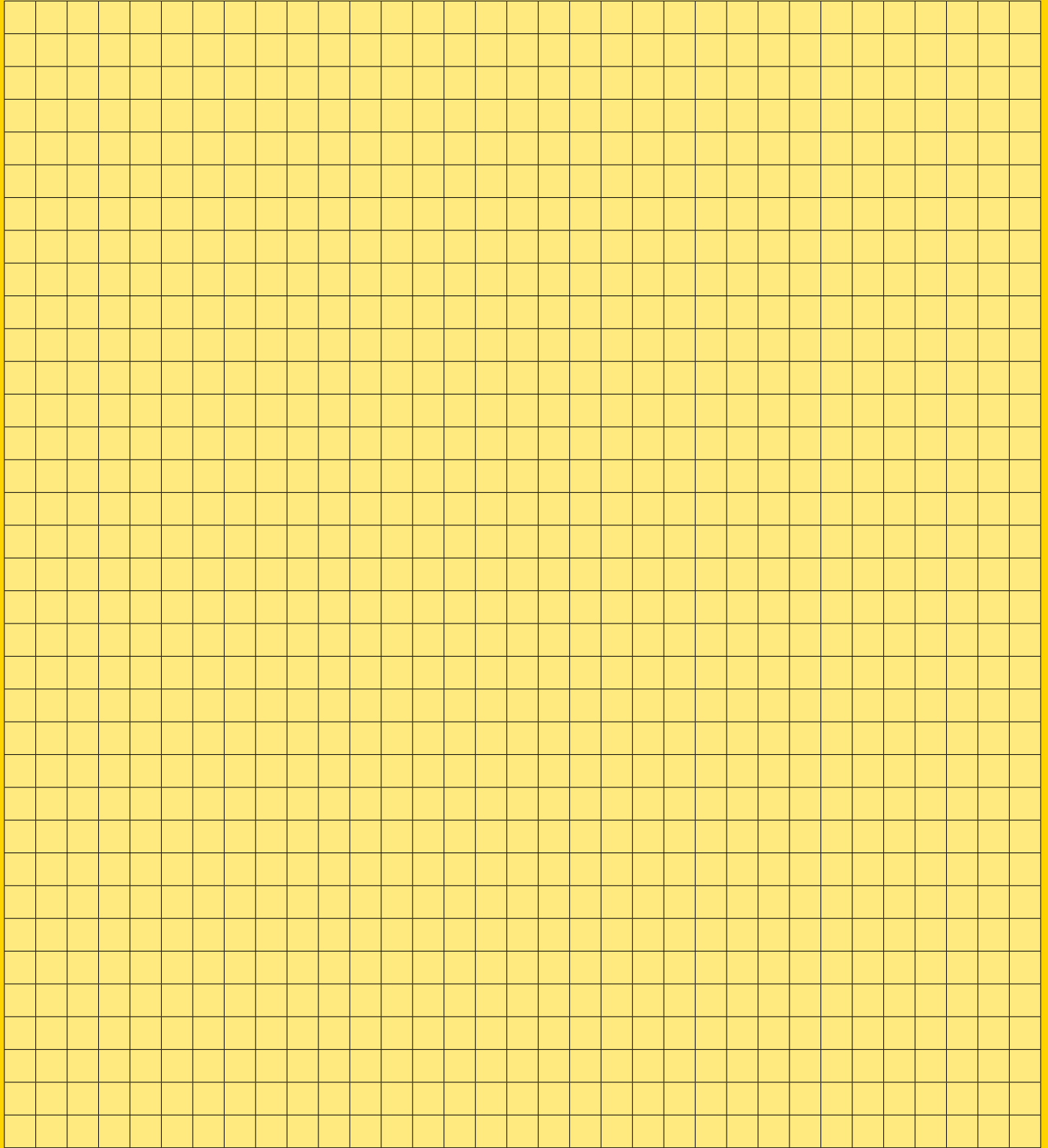

Barum – A Trademark of the Continental Corporation

**Continental Aftermarket GmbH**

Guerickestraße 7  
D-60488 Frankfurt  
Germany

Tel.: +49 (0) 69 7603-1

Fax: +49 (0) 69 761061